

YAESU

FRG-100

OPERATING MANUAL

YAESU MUSEN CO., LTD.

C.P.O. BOX 1500

TOKYO, JAPAN

Contents

General Description	1	Checking Memory Contents	21
Specifications	2	Checking & Programming Memories from VFO Mode	21
Accessories & Options	3	Auto Memory Arrangement	21
Front Panel Controls & Connectors	4	Erasing a Memory Channel	22
Liquid Crystal Display	5	Memory Tuning	22
Rear Panel Controls & Connectors	6	Writing Memory Contents to VFO	22
Receiver Installation	7	Scanning Operation	23
Preliminary Inspection	7	Introduction	23
Location of the Receiver	7	Memory Scan	23
Grounding	7	Scan Stop	24
DC Power Connection	7	Memory Scan Skip	24
Front Panel Angle & Reference Chart	7	Band Scanning: Memories Lo & Hi	24
Shortwave Signals & Propagation	8	Priority Scan	25
Antenna Considerations	9	Selectable Group Scan	25
Antennas for LF & MW Reception	9	Common Group Channel Scan	26
Antennas for Shortwave	10	Common Letter Group Scan	26
Dipole Construction	10	Using Selectable Group Scanning	27
Typical Antenna Installations	11	Broadcast Band Scanning	27
Power-Up & Custom Settings	12	Clock & Timer Operation	28
Operation	13	12/24 Format & Default Display	28
Getting Started Tutorial	13	Default Display	28
Frequency Tuning	13	LCD Backlighting	28
Programmable Tuning Steps	14	Hourly Time Annunciator	29
Fast Tuning Key	13	Timer & Sleep Functions	29
Signal Reception	15	Timer Cycling and Operation	29
AM Broadcast Reception	15	Diagnostic Test	30
Broadcast Band Selection Mode	15	Installing Internal Accessories	31
SSB Reception	15	Top Cover Removal	31
Adjusting SSB Carrier Frequency Offset	16	FM UNIT-100 Installation	31
CW (Radiotelegraphy) Reception	16	Beep Volume Adjustment	31
Adjusting BFO "Beat Note"	17	Optional CW Crystal Filters	32
Selectable CW Sideband	17	Fuse Replacement	32
Reverse BFO Offset	18	Bottom Cover Removal	33
FM Reception	18	TCXO-4 Installation	33
Receiver Squelch Setting	19	Lithium Battery	33
Fading & Noise Rejection	19	Backup Switch	34
Noise Blanker Setting	19	Cover Screws	34
RF Attenuation	19	CAT Control System	35
Beep Settings	19	Data Returned From FRG-100	35
Changing Receiver Selectivity	20	FRG-100 CAT Commands	36
PLL Offset	20	Status Update Data Organization	37
Memory Operation	21	Status Update Data Selections	38
Introduction	21	Read Flags Data	38
Memory Storage	21	Status Update Data Selection	38

General Description



The FRG-100 is a high-performance communications receiver providing general coverage reception in CW, SSB, AM and FM modes from 50 kHz to 30 MHz. The latest microprocessor technology is used to merge performance and reliability with easy operation and functional simplicity. The FRG-100 incorporates features that both casual and serious shortwave listeners will appreciate.

Reception modes and most receiver functions are push-button selectable from the front panel. A crisp back-lit LCD with adjustable brightness provides frequency read-out and important operational status at a single glance. Selectable tuning steps of 10 Hz, 100 Hz, or 1 kHz are standard, with other tuning steps user-programmable. Fifty tunable memories store frequency and mode information, two additional memories provide band-edge information used for scanning.

Two programmable 12/24-hour clocks and On/Off/Sleep-timers enables you to automatically switch the receiver on/off to record or listen to your favorite broadcasts. Multi-function scanning enables searching for new stations or scanning within known bands.

A special Broadcast Band mode enables convenient selection of 16 pre-programmed international broadcast bands (LW ~ 11 Meters). The FRG-100's adjustable SSB Carrier Offset permits you to custom tailor the receiver's audio response. CW enthusiasts will enjoy the Reverse BFO Offset and Selectable CW Sideband. Installation of the optional 250 or 500 Hz narrow filter further enhances CW reception and interference rejection. Other features include a noise blanker, all-mode squelch, and relative signal-strength meter.

The Yaesu CAT system provides a direct link to the CPU in the FRG-100, allowing a personal computer with the Yaesu FIF CAT Interface Unit to add other functions as desired, such as automatic tuning, customized scanning systems and of course remote control of most receiver functions.

Before connecting the power cord, you should read the *Receiver Installation* section carefully, heeding the warnings in that section to avoid damage to the set. After installation, please take time to work through the *Operation* chapter. This manual is intended to be read while sitting in front of the FRG-100, so you can try out each control and feature as they are described.

Specifications

Frequency range: 50 kHz ~ 30 MHz

Circuit type: dual-conversion superheterodyne

Reception modes: USB, LSB, CW, AM,
FM (Optional)

Intermediate frequencies: 1st: 47.21 MHz
2nd: 455 kHz

Frequency stability: $< \pm 10$ ppm, from $-10 \sim +50^\circ\text{C}$
 $< \pm 2$ ppm, from $0 \sim +50^\circ\text{C}$
(w/TCXO-4 option)

Squelch sensitivity:
1.8 ~ 30 MHz (CW, SSB, AM): $< 2.0 \mu\text{V}$
28 ~ 30 MHz (FM): $< 0.32 \mu\text{V}$

Standard Tuning Steps: 10 Hz/100 Hz (CW, SSB)
100 Hz /1 kHz (AM, FM)

IF rejection (1.8 ~ 30 MHz): 70 dB or better

Sensitivity:

Spurious Signals:

(for 10 dB S/N, 0 dB μ = 1 μV FM 12 dB SINAD)

Amateur/BC Bands: S/N 10 dB or better

Other Bands: S/N 20 dB or better

Frequency \Rightarrow Mode (BW) \Downarrow	100 ~ 250 kHz	250 ~ 500 kHz	0.5 ~ 1.8 MHz	1.8 ~ 30 MHz
SSB, CW (2.4 kHz)	$< 4 \mu\text{V}$	$< 1 \mu\text{V}$	$< 2 \mu\text{V}$	$< 0.25 \mu\text{V}$
AM (6kHz)	$< 10 \mu\text{V}$	$< 2 \mu\text{V}$	$< 4 \mu\text{V}$	$< 1 \mu\text{V}$
FM (28 ~ 30 MHz) (15 kHz)	—	—	—	$< 0.5 \mu\text{V}$

Image rejection: (1.8 ~ 30 MHz): 60 dB or better

Maximum audio power output:
at least 1.5 watts into 4 Ω with $< 10\%$ THD

Selectivity: (-6/-60 dB): ripple 3dB or better

Audio output impedance: 4 to 8 Ω

Modes	Minimum 6 dB BW	Maximum 60 dB BW
CW narrow (optional)	240 Hz	700 Hz
CW narrow (optional)	500 Hz	1.1 kHz
SSB, CW	2.4 kHz	4.5 kHz
AM Narrow	4 kHz	15 kHz(-50 dB)
AM	6 kHz	18 kHz(-50 dB)
FM (optional)	15 kHz	30 kHz

Antenna impedance: Lo-Z 50 Ω unbalanced
Hi-Z 450 Ω unbalanced

Supply voltage: DC 11 ~ 14 V, negative ground

Power consumption: (max.): 1.2 A

Dimensions: (WHD): 238 \times 93 \times 243 mm

Weight: (approx.): 3 kg (6.6 lb.)

Specifications are subject to change, in the interest of technical improvement, without notice or obligation.

Accessories & Options

Supplied Accessories

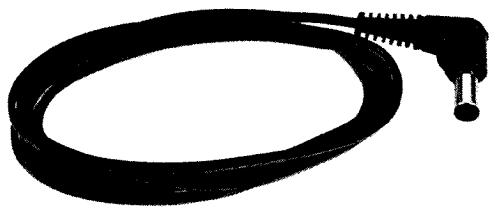

DC Power Cord (T9019399) 1 Ea.



Mini Phone Plug
(P0090034) 1 Ea.



Sub-Mini Phone
Plug (P0090877) 1 Ea.

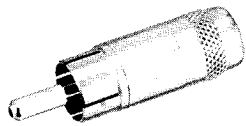

RCA Plug (P0090544) 1 Ea.

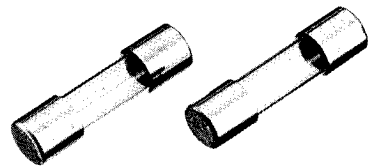

Fuse (Q0000021) 2 Ea.

Options

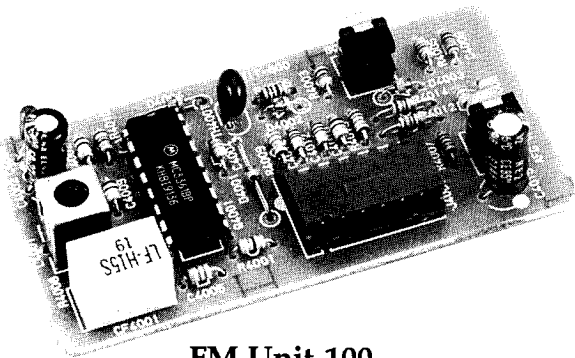

FM Unit-100

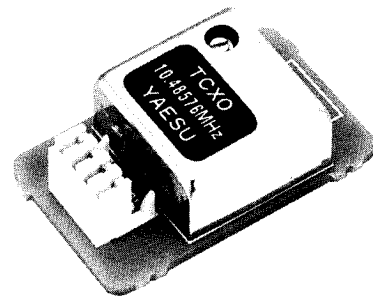

TCXO-4



CW Narrow Filter
YF-110C (500 Hz) or YF-110CN (250 Hz)

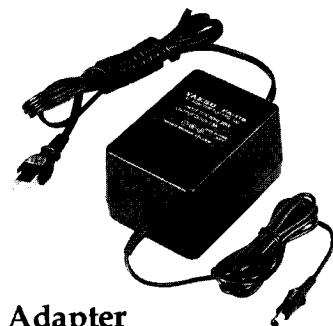

AC Adapter
PA-11B/C (117/220~234 VAC)

Front Panel Controls & Connectors

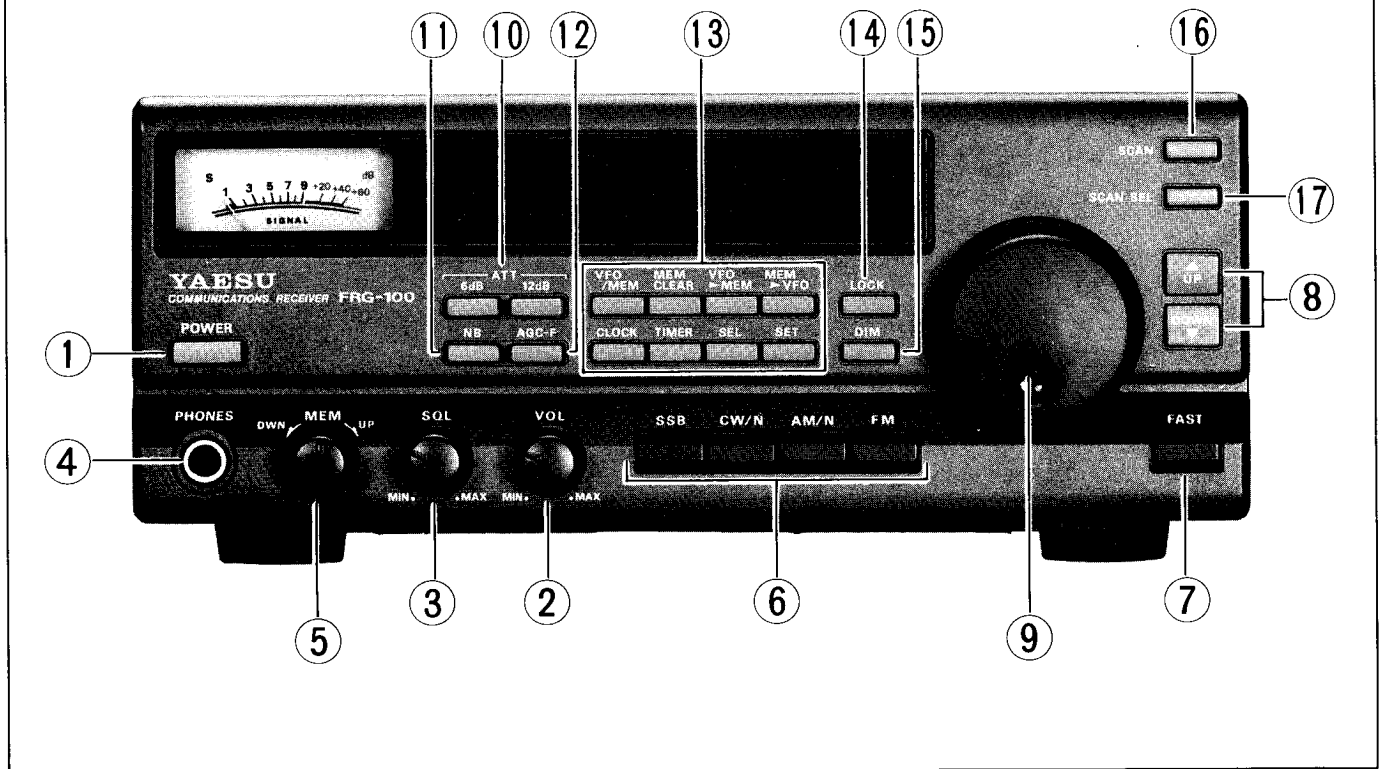

1 POWER This button turns the receiver on/off, however, the clock and memory backup functions stay on and are not affected. To avoid switching spikes, make sure it is OFF when you apply a DC power source to the rear panel jack.

2 VOL This adjusts the volume of the receiver loudspeaker or headphones. It should be set for a comfortable level only when the **SQL** control is set fully CCW, so that a signal or noise can be heard. Adjusting this control *does not* affect the audio level at the **REC** jack (described later).

3 SQL The squelch control sets the signal level at which the receiver audio is muted in all modes. This control is normally kept fully CCW, except when scanning, and during FM reception. Scanning stops when the squelch is open. See page 19 for squelch setting.

4 PHONES This 1/4" jack accepts a headphone with either a 2 or 3-contact plug. When a plug is installed, the loudspeaker is disabled.

5 MEM DWN ↔ UP This rotary control steps through the 52 memory channels.

6 SSB CW/N AM/N FM These keys select the various reception modes. Pressing the **SSB** key

again will toggle between USB and LSB mode, pressing the **CW/N** and **AM/N** keys a second time will select the narrow IF filter (if installed).

7 FAST This key enables faster tuning rates using the main VFO knob by increasing the tuning increment (step) size. Increment steps are determined by mode selection and you. Standard tuning increments are 100 Hz & 1 kHz for AM/FM and 10 Hz & 100 Hz for SSB/CW. Custom tuning steps can be programmed for special applications, see page 14.

8 UP ▲ DOWN ▼ Pressing either key momentarily will step the receive frequency up or down 100 kHz or 1 MHz (selected by the **FAST** key). Continue holding either key for repeated stepping.

9 This knob tunes the operating frequency of the VFO or a recalled memory. Tuning rate is determined by the frequency step selected.

10 ATT 6dB, 12dB, These switches provide 6 or 12 dB of RF attenuation to protect the receiver front-end from strong signal overload. A total of 18 dB of attenuation can be obtained by selecting both.

11 NB The noise blanker helps to reduce interference experienced from man-made impulse-type noise. Normally, if noise is not present, this switch should be kept in the un-depressed position.

12 AGC-F Pressing this key sets the receiver Automatic Gain Control for *fast* recovery, which reduces fading of received signals. This is preferred for SSB & CW reception.

13 The following keys control various memory and VFO operations and are described in detail in the *Operation* chapter of this manual:

VFO/MEM This key selects VFO or memory channel tuning and operation.

MEM CLEAR Pressing this key for longer than 1/2 second will erase the currently stored information in memory. Repeating the key will re-enter the information if new data has not been stored.

VFO ► MEM To store the currently displayed frequency and data into memory, press *and hold* this key for longer than 1/2 sec.

MEM ► VFO Shifts the contents of the selected memory channel into VFO without erasing the stored memory data.

CLOCK Used to select and enter the correct time on both clocks.

TIMER Used for selecting and programming Timer operation.

SEL and **SET** These keys are used with the Timer and Clock functions.

14 LOCK This button disables the main VFO tuning knob, other controls and functions are not affected.

15 DIM This key selects bright or dim backlit LCD illumination. Pressing this key while the radio is turned off will illuminate the display for approximately 5 seconds.

16 SCAN Pressing this button starts scanning operation, pressing it again stops the scanning.

17 SCAN SEL Repeatedly pressing this button selects the receiver scanning modes (memory scan, priority scan, or group scan). These are covered in greater detail in the *Operation* chapter.

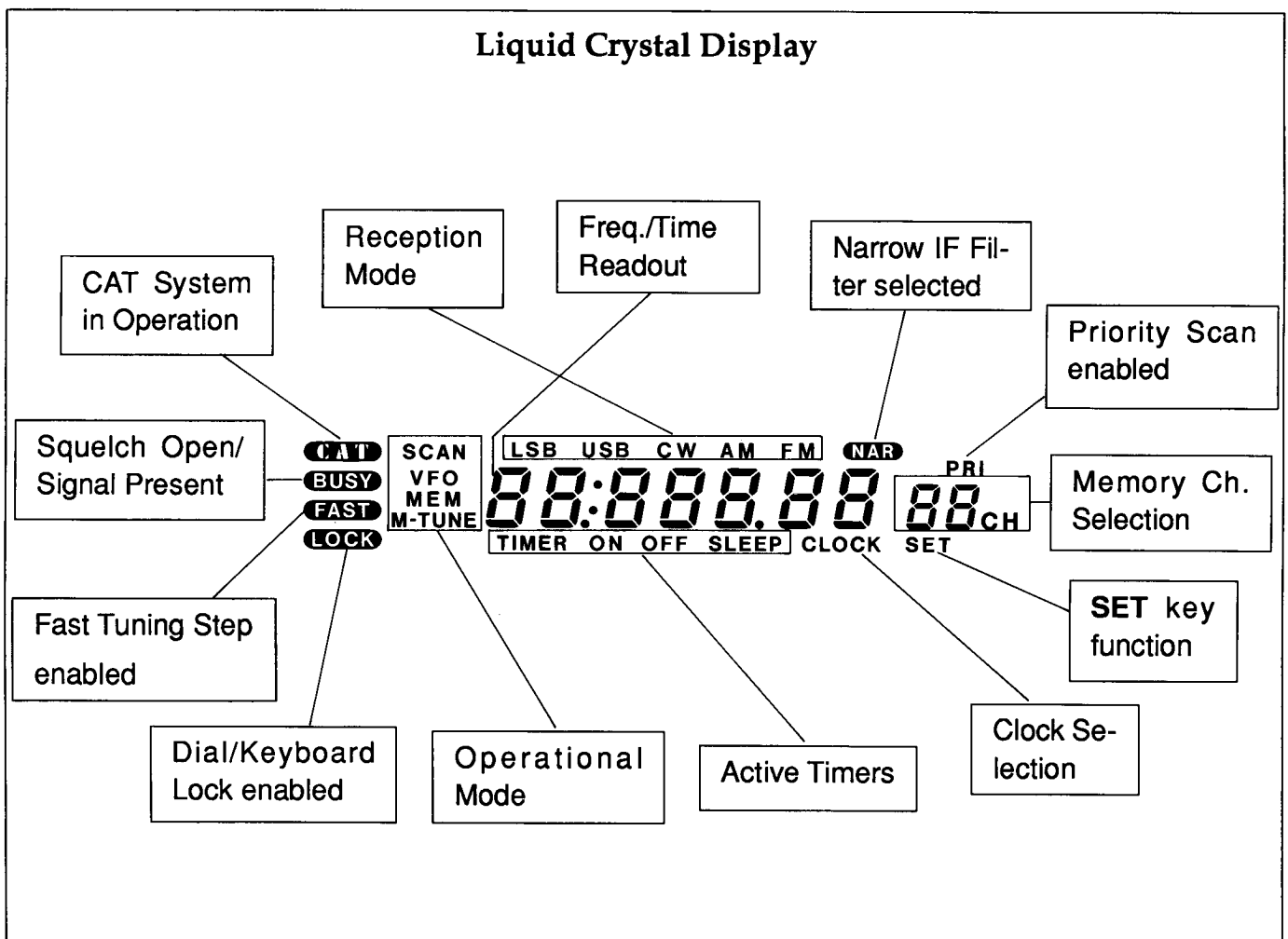

Rear Panel Controls & Connectors

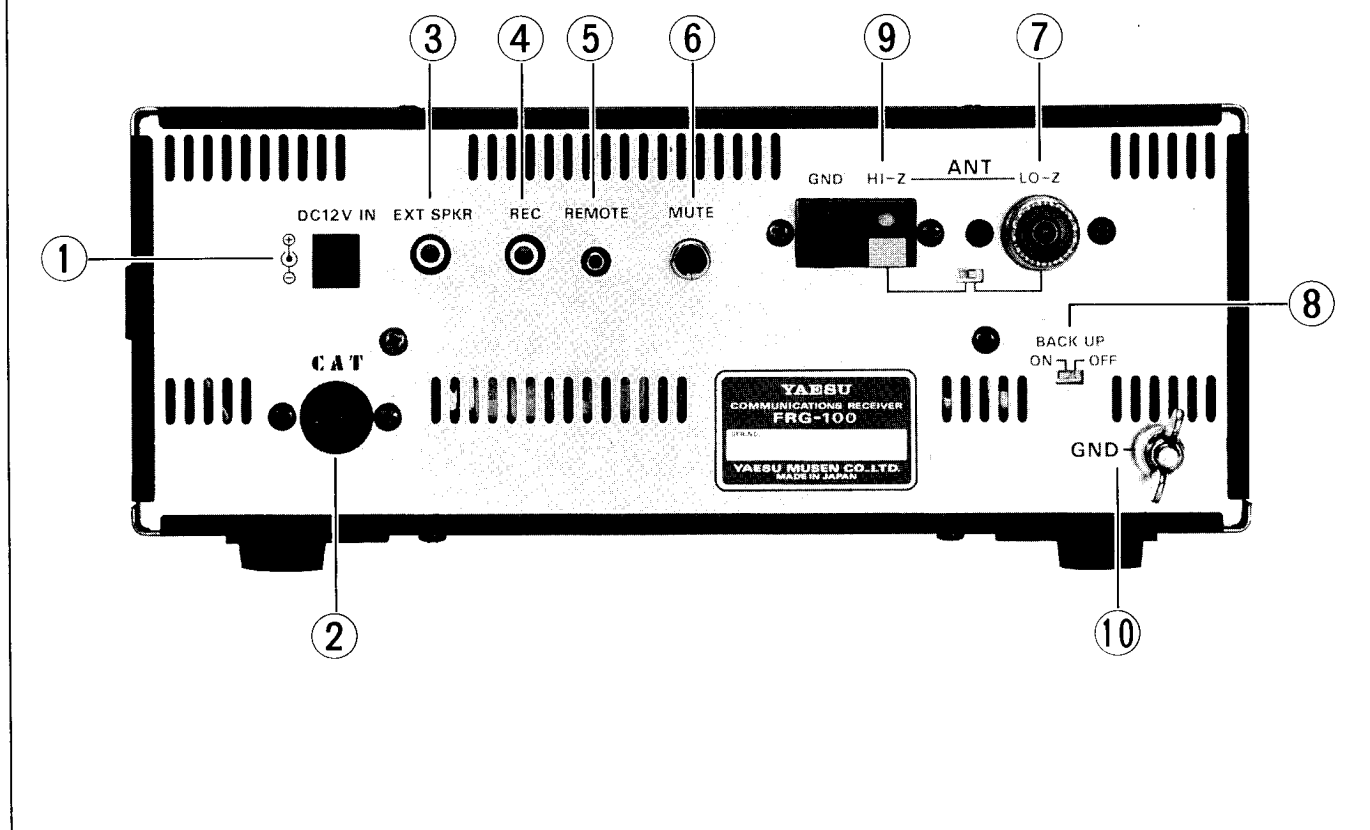

1 DC 12 V IN This is the 13.8-volt DC power connector. Be sure to use a coaxial-type barrel plug. A stable regulated power supply capable of providing at least 2 amps is recommended. Be sure to observe proper polarity and ensure that the center conductor is wired + (positive) and the outer conductor is — (GND).

2 CAT This 6-pin DIN plug allows external computer control of the FRG-100 when used with the optional FIF Interface and software. See the *CAT Control System* chapter for details.

3 EXT SPKR This 2-contact mini phone jack provides receiver audio for an external loudspeaker with an impedance of 4 - 16 Ω . Inserting a plug in this jack disables the loudspeaker.

4 REC This jack provides a constant level (40 mV @ 50 k Ω) audio output, which is *unaffected* by the **VOL** control. This audio can be used for recording purposes, and for connection to data demodulator/decoder equipment.

5 REMOTE Use this jack to remote control an external tape recorder. When receiver squelch

opens, this jack goes to ground, closing the circuit to activate a tape recorder or other device.

6 MUTE If using the FRG-100 with a transceiver, shorting this jack during transmit will mute receiver output and attenuate RF signal input. Check with information provided with your particular transceiver for proper connection.

7 ANT LO-Z Connect the 50 Ω coaxial feed line to your low-impedance antenna here using a type-M (PL-259) connector. See the *Antenna Considerations* chapter for antenna types and installation.

8 BACK UP ON/OFF This switches the lithium memory back-up battery. It normally should be left in the **ON** position.

9 ANT HI-Z Use these spring-loaded terminal connectors to connect a high-impedance antenna.

10 GND Connect this terminal to a quality earth ground. See the *Receiver Installation* chapter for details on grounding.

Receiver Installation

Preliminary Inspection

Inspect the receiver thoroughly immediately upon opening the packing carton. Confirm that all the controls and switches work freely, and inspect the cabinet for damage. If any damage is found, contact the shipping company (or dealer, if you purchased it over the counter) right away. Save the packing materials in case you need to return the set for service.

If you purchased optional internal accessories, install them as described in *Installing Internal Accessories* chapter after first carefully reading this manual.

While reading this chapter, refer to the photos of the panels for the locations and functions of the controls and jacks.

Location of the Receiver

To assure long life of components, make sure to provide adequate ventilation around the cabinet. Do not place the receiver on top of other heat generating devices, or place objects such as books or papers on top of the receiver. Place the receiver on a hard flat surface. Avoid heating vents and window locations that could expose the receiver to excessive direct sunlight, especially in hot climates. Before plugging in the receiver the first time, make sure your supply voltage is correct, and that your ground and antenna are connected as described next.

Grounding

For protection from shock and proper performance, connect the **GND** terminal on the receiver rear panel to a good earth ground, using a heavy braided cable of the shortest length possible. A good earth ground can be obtained by connection to a conductive rod driven several feet into the earth, or alternately by connection to a nearby cold water pipe (check in newer dwellings in case plastic PVC pipe is installed in-line since this would insulate the connection from earth-ground). All other station equipment should be connected to the same ground cable, as close together as possible. If you use a computer with or near the FRG-100, you may need to experiment with grounding and location of both the receiver and computer to suppress possible-computer-noise received by the radio. Ask your Yaesu dealer, or consult a radio handbook if you

need information on the best way of obtaining a good connection to ground at your location.

Caution!

Never use natural (LP) gas lines or electrical conduit piping as an earth ground connection due to the risk of explosion or electrical shock. If you are unsure about the use of piping in your dwelling, first check with your local utilities before attempting to make any connections.

DC Power Connection

A DC power cable is supplied with the receiver. At one end is a pre-assembled coaxial-type barrel plug for connection at the rear panel of the radio, the other end is to be connected to an appropriate DC power source (if the optional PA-11 B/C AC adapter is used, this cable is not needed, and should be kept for possible future use). Before wiring to any DC power source, first ensure proper voltage and polarity. *Please note the caution below.* To avoid damage from voltage transients, ensure that the receiver **POWER** switch is OFF whenever connecting or disconnecting DC power.

Front Panel Angle & Reference Card

If your installation places the FRG-100 much below eye level you may want to prop up the front of the radio for more comfortable viewing. A wire bail on the bottom of the FRG-100 can be folded down for this purpose. A handy laminated world time and receiver functions card is also accessible beneath the bottom cover. Simply slide it out from from the dual slotted rails.

Caution!

Permanent damage can result if improper supply voltage is applied to the receiver. Your warrant does not cover damage caused by application of AC, reversed polarity DC, or DC outside of the specified range of 11~14 VDC.

Shortwave Signal & Propagation

Shortwave signals are transmitted by stations running high power using elaborate antenna systems. But good reception depends a property of the ionosphere (a layer of the atmosphere) which causes the reflection of signals back to earth.

Depending on several factors, including the time of the day, the season, and current solar activity (determined primarily by sunspots), the optimum frequency for reflection over a particular distance will change. Thus, in order to hear distant stations over a long period of time on a particular day, you will likely have to change your receiving frequency (consistent with the broadcast schedules) in order to adjust for changing propagation conditions.

Daytime propagation conditions are generally best on frequencies from about 12 - 14 MHz and higher. Propagation at night will generally be best on the 2 - 15 MHz bands. There are exceptions, however; during periods of high solar activity, the 21 MHz band may, for example, be excellent for long distance propagation well into the night. However, it would be highly unusual for the bands below about 8 MHz to support transoceanic propagation throughout the daytime period.

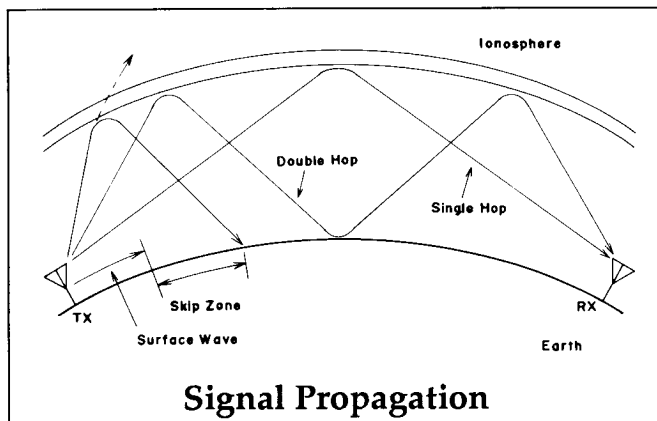

When reading broadcast station schedules, consider not only your local time, but also the local time *at the transmitter location*. Let us use the example of two broadcast stations, one in Tokyo, and one in Moscow, both operating on 6 MHz at 6:00 P.M. local time (for our example, let us say that you live in New York City, U.S.A.). Because there are night-time conditions covering most of the North Atlantic path that a signal would follow from Moscow to New York, you would normally have a good chance of receiving the broadcast from Moscow. However, the path

from Tokyo to New York is largely a *daylight* path, and as discussed earlier, it would be difficult, if not impossible, to hear Tokyo at the same time and frequency.

However, the Tokyo schedule may include a broadcast on 15 MHz at the same time. The 15 MHz region (± 5 MHz) is a middle ground which often supports around-the-clock propagation. You would have a better chance of hearing Tokyo on 15 MHz at this time, because the path is largely over daylight.

Broadcast stations are aware of this phenomenon, and this is why their schedules indicate "North American Service" or "Programming Beamed at Southeast Asia." They take propagation conditions into consideration, and aim their antennas carefully, to try to reach their target at a time when people will be at home to listen.

The season is also important for several reasons. For example, at 4:00 P.M. in New York in June, the sun is still high in the sky. But at 4:00 P.M. in December, twilight is fast approaching, and night-time conditions are taking over the North Atlantic path. Broadcast stations adjust their schedules to use the lower frequencies (below 10 MHz) more heavily in the winter, because of the increased signal distance covered.

Signals do not always follow the shortest distance between two points (called the "Great Circle" path). They sometimes follow a bent path, or go exactly opposite of the great circle. This is why it is sometimes possible to hear Tokyo from New York on 7 MHz late in the afternoon in the winter, even though the the Great Circle path is in daylight; the signals travel along a darkness path around the world. The fact that many stations are louder, and that the transmitting antenna may not be beamed on the optimum path at that time, makes reception extremely difficult. But this is the excitement of shortwave listening—hearing the unexpected.

In conclusion, use higher frequencies (15 MHz and above) as your main daylight bands, and frequencies below 15 MHz for prime night-time reception. Look for a peak in 26 MHz propagation towards the East an hour or so after your sunrise, and toward your West around sunset. Careful planning of your operating times, frequencies, and the use of broadcast schedules will provide endless hours of listening enjoyment from around the world!

Antenna Considerations

The FRG-100 was designed to operate with an antenna connected to the rear panel connectors. This allows you to take full advantage of the better reception possible using outdoor antenna systems, which would not be possible with an internal "loopstick" or telescoping whip antenna, such as used on portable radios. However, if portability is required or if there is no space for an external antenna, the FRG-100 can be used with an indoor or "active" antenna. In most cases, however, a proper outdoor antenna cut or tuned for the receiving frequency range will usually provide better performance.

The type and installation of the antenna are critical to the proper performance of your receiver. While some strong signals can be received with just about any piece of wire connected to the proper terminal, long distance (DX) or low power stations will require additional effort and care in choosing, constructing and installing the antenna. If you are new to antenna theory and construction, please refer to a shortwave antenna handbook for explanations and ideas. A few basic antennas are described next to help get you started.

Antennas for Low and Medium Frequency Reception (50 ~ 1600 kHz)

Fair all-around reception is possible using a single random-length wire as long as possible connected to the white **HI-Z** spring-loaded terminal on the rear panel. The wire should be supported as high above ground as possible using insulators at the ends, and should be located as far as possible from any other objects. Insulated wire is generally preferable, mainly because of its corrosion resistance. In general, the longer the wire, the better the performance in these bands. A good earth ground connection, as described in the *Receiver Installation* chapter, is essential to good performance with a random wire antenna.

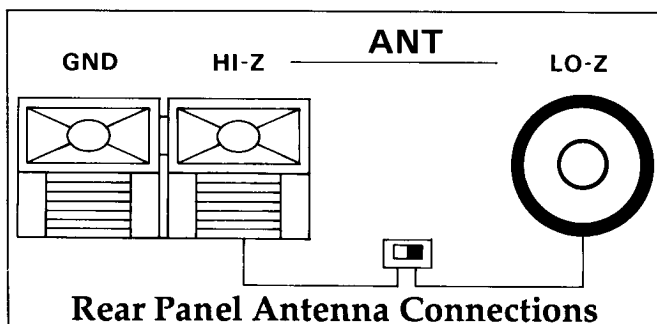

If there are strong broadcast stations located nearby, a random wire antenna can receive so much energy from those stations that the receiver may overload, particularly if the antenna is very long. This can result in distorted signals appearing on the wrong frequencies (where the station is not transmitting). The **ATT** control on the FRG-100 is provided to reduce the overall sensitivity of the receiver and thus reduce the susceptibility to such overloading, but also reduces the strength of the desired signals. In situations where this is unacceptable, we recommend using an antenna tuner connected between the receiver and antenna, allowing precise impedance matching at the receiving frequency, while suppressing signals at other frequencies. An antenna tuner allows a random wire antenna to provide good performance at LW and MW frequencies.

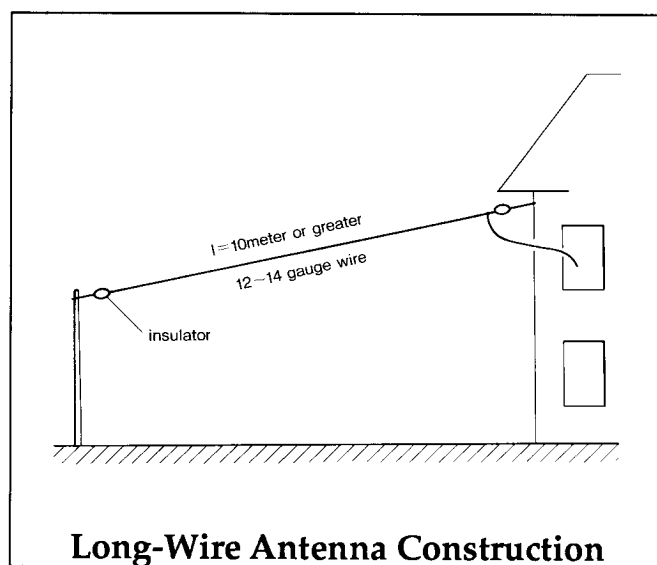

Antennas for Shortwave (2 ~ 30 MHz)

Optimum performance on frequencies between 2 and 30 MHz can be obtained using a tuned or self-resonant antenna with an impedance of 50 Ω at the receiving frequency. However, such antennas generally perform best within a certain band, giving reduced performance outside this range. For correct operation any antenna should be connected to the receiver by either as coaxial cable (to the **LO-Z** 50- Ω coaxial jack), or a high-impedance "open wire" feed line to the spring-loaded **HI-Z** and adjacent black terminals, depending on the feed point impedance of the antenna (which must be matched by the feedline and receiver connections).

Performance on a specific band can be achieved using a simple resonant dipole antenna, consisting of two equal-length wires cut for the center of the desired band. The dipole can be constructed from available materials, or from a kit available through your dealer. If you wish to make such a dipole for optimum performance at a certain frequency, the following formulas can be used to obtain the correct overall length (add a little extra to allow for attaching at the ends).

Length (meters) = $142.5/\text{frequency (MHz)}$, or

Length (feet) = $468/\text{frequency (MHz)}$

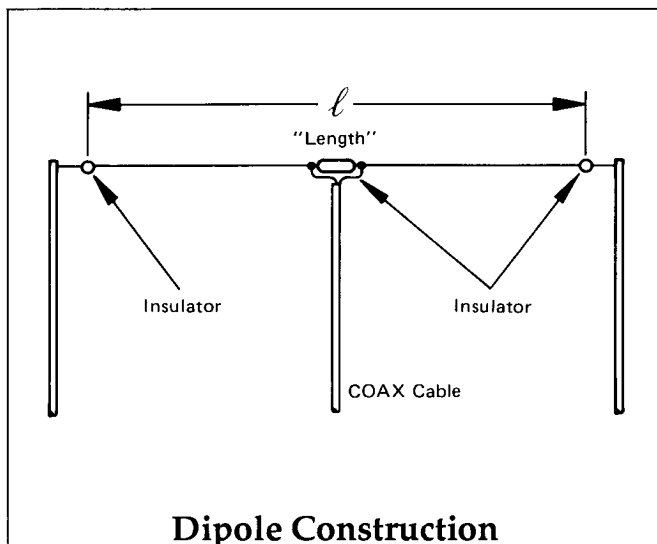

Dipole Construction

The two legs of the dipole must be insulated from their supports at each end, and from one another in the center. Reception of long distance (DX) stations requires that horizontal antennas be as *high above ground as possible* (with a height of a little over twice the length of the antenna calculated above considered about optimum). Connection should be made using 50 or 75 Ohm coaxial cable, with the center conductor connected to one end and the shield to the other. The other end of the cable connects to the **LO-Z** coaxial jack on the rear panel of the receiver. If the antenna is installed vertically, it need not be so high (the optimum center feed point is about the same as the length of the above formulas), but in this (vertical) case the earth ground is more critical.

Caution!

Do not install any antenna near electric power lines, where there could be any chance of the antenna coming into contact with live wires.

Important!

For proper reception, ensure that the **LO-Z HI-Z** antenna selector switch on the rear panel of the receiver is in the correct position for the antenna being used. To switch antennas, ensure the receiver is turned off and the power is disconnected, then gently slide the switch lever using the tip of a pointed object (such as a ball-point pen).

The above HF antennas can be used with varying success on frequencies outside of their optimum range, in which case an antenna tuner as mentioned earlier can provide considerable improvement in performance. Also, good low frequency reception can sometimes be achieved with an HF antenna if the two feedline conductors are connected together to the white **HI-Z** terminal on the receiver, but this can also introduce overloading or objectionable noise.

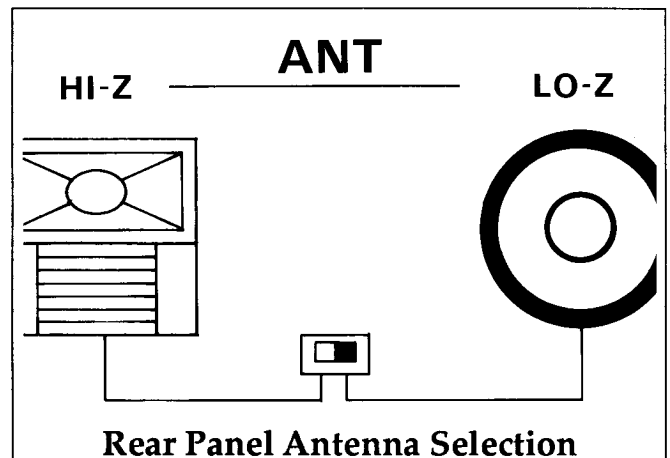

Rear Panel Antenna Selection

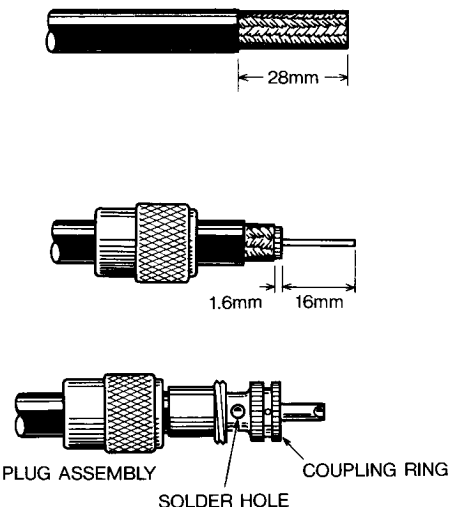

Installing PL-259 Connector

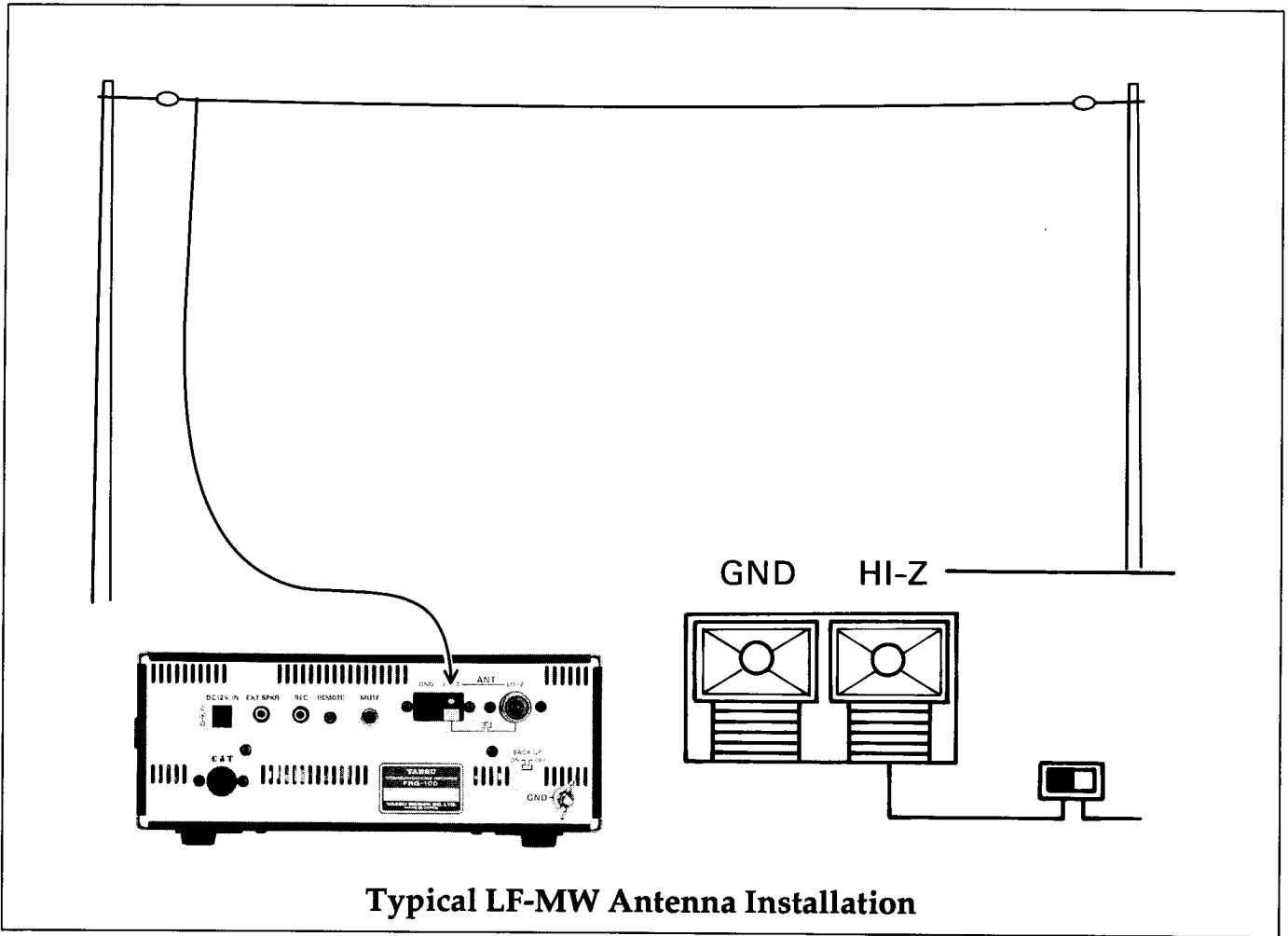

Typical LF-MW Antenna Installation

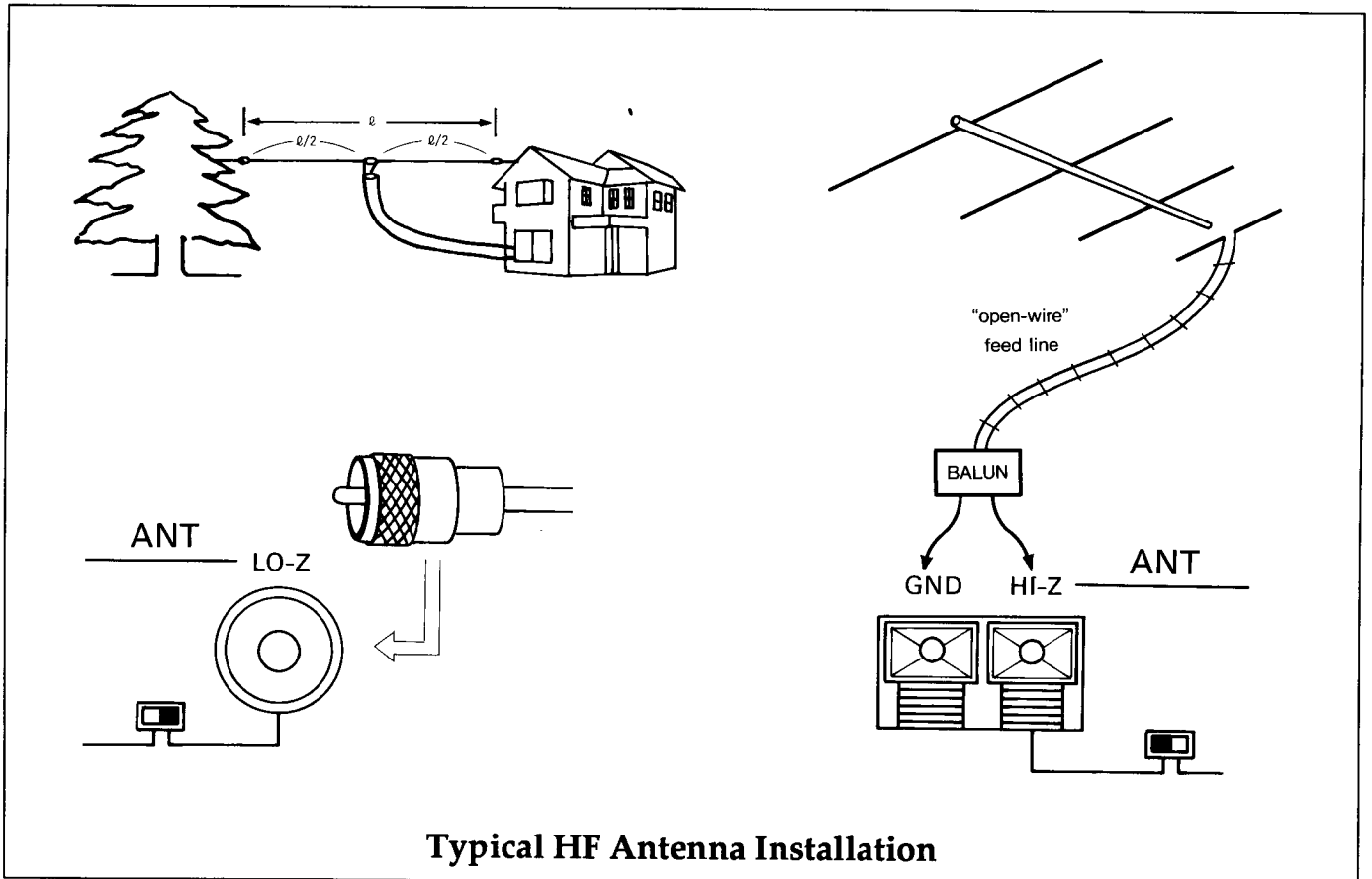

Typical HF Antenna Installation

Power-Up Customization & Button Combination Settings

By pressing and holding certain buttons while switching on the FRG-100, you can change many default settings, and customize features to your own preference. Other important settings can be selected by pressing and holding **SET** with other key combinations, as described in the lower table.

Power-Up Functions	Hold this button & turn on	Comments	Ref Pg #
Default Display	VFO/MEM	Toggles display between frequency (default) and time	28
Erase ALL Memorized Information	MEM CLEAR	Clears the contents of all memory channels, returns radio to factory default settings	22
FAST Tuning Rate	VFO►MEM	Halves the default FAST tuning rate	13
Memory Frequency Arrangement	MEM►VFO	Arranges memorized frequencies in channel order from lowest to highest frequency.	21
Front Panel Lock	LOCK	Locks ALL front Panel Keys.	14
12/24 Hour Clock Display Format	CLOCK	Toggles between 24-hour (default) and 12-hour format.	28
Hourly Beep Annunciator	TIMER	Emits 3 beeps, every-hour, on-the-hour.	29
Scan Stop	SCAN	Scan Resume must be manually initiated	24
Selects Group Scan Mode	SCAN SEL	Toggles between group <i>channel</i> (default) and group <i>letter</i> scan.	26
10 Hz Digit Display	DOWN▼	Turns off the 10 Hz frequency display digit.	14
FAST Key Function	FAST	Selects continuous (default) or <i>momentary</i> -type	14
Scan Resume Operation	SEL	Toggles between <i>carrier</i> -delay (default) and <i>time</i> -delay scan resume operation.	23
Selectable CW Sideband	CW/N	Permits matching CW carrier offset to LSB or USB (default)	17
LCD Backlight	DIM	Selects momentary (default) or continuous LCD backlighting	28
Receiver Diagnostic Test	SET	Performs self-test and displays CPU version number	30

SET Functions	Hold SET and press...	Comments	Ref Pg #
Beep Tone	VFO/MEM	Adjusts Beep Tone from 270 ~ 3520 Hz (880 Hz default)	19
Turn On/Off Beep Tone	VFO/MEM then SEL	Enables/Disables Beep Tone (normally enabled)	19
SSB Carrier Offset	MEM CLEAR	Adjustable SSB Carrier Offset from 452 ~ 458 kHz for tailoring audio response (default 453.500 kHz)	16
CW Beat-Note	VFO►MEM	Selectable 400, 500, 600 (default), or 700 Hz beat note.	17
Custom Tuning Steps	FAST	Selectable tuning increments from 100 Hz ~ 100 kHz	14
Broadcast Band Selection	UP ▲	Selection of 16 International Broadcast Bands	15
IF Bandwidth Selection	SEL	Selectable default IF selectivity for each mode	20
Reverse BFO Offset	CW/N	Places BFO offset below or above (default) IF center-frequency	18
PLL Offset	MEM►VFO	Permits fine-tuning (± 3 kHz) of local oscillator	20
Memory Scan Skip	SCAN	"Locks-out" a Memory Channel from scanning	24

Operation

Getting Started Tutorial

Basic operation of the FRG-100 is simple, however, some of the more advanced features can be confusing at first if you are not familiar with it's function. Please read this section carefully while trying out each step on the receiver. Refer to the photos and panel diagrams for the locations and basic functions of the controls and jacks.

Before plugging in the receiver for the first time, ensure that your power supply voltage is correct, and that your ground and antenna are connected as described in the *Receiver Installation* chapter. Then preset the following controls:

POWER: Off **VOL:** 10 o'clock

SQL: counter-clockwise (CCW)

Connect your DC power source at the receiver rear panel. The flashing clock time should be visible on the front panel display, this is normal. Now press the **POWER** switch on. The meter and display should light up. If the display is too bright or too dim, press the **DIM** key to select the brightness you prefer. Adjust the **VOL** control for a comfortable audio level at the speaker or headphones (if they are used). If nothing happened, re-check your power connections.

Take a moment to study the display. You should see "VFO" or "MEM" at the left, the receive frequency digits, mode selection directly above, and the "BUSY" indicator to the left showing that the squelch is open. Rotate the **SQL** control clockwise (CW) to check that the indication disappears when the squelch closes, and then return it fully CCW. At the right of the frequency read-out you will see a smaller two-digit memory channel number.



For now, we want to begin in VFO operation. You may find it easier to switch between VFO and Memory operation by simply pressing the **VFO/MEM** button. This method allows you to leave any settings in the VFO. If "VFO" does not appear to the left of the frequency display, press the **VFO/MEM** again to select it.

Frequency Tuning

The FRG-100 provides a combination of the main tuning knob, up/down keys, and selectable tuning speeds to allow fast and accurate frequency selection. After first selecting the desired receiving mode at the bottom of the panel, press the **UP ▲ DOWN ▼** buttons (to the right of the tuning knob) to step to a frequency band for reception. Pressing each key *momentarily* will step the frequency in the direction chosen, and is accompanied by an audible beep from the loudspeaker. Pressing *and holding* either key results in repeated frequency stepping until released. The main tuning knob can then be used for tuning around the immediate vicinity or band just selected. Pressing the **FAST** key will increase the step size and tuning rate as indicated in the chart below. *Note:* The **FAST** tuning rate can be *halved* by turning the radio off, then pressing *and holding* the **VFO►MEM** key while powering on again, repeating the sequence returns tuning to normal.

Tuning & Scanning Steps

Control ↓	Mode ⇒	LSB, USB CW	AM & FM
Tuning knob	Normal	10 Hz	100 Hz
	w/ FAST button	100 Hz	1 kHz
UP ▲ DOWN ▼ Push buttons	Normal	100 kHz	100 kHz
	w/ FAST button	1 MHz	1 MHz
One revolution of tuning knob	Normal	5 kHz	50 kHz
	w/ FAST button	100 kHz	1 MHz
	FAST / 2	50 kHz	500 kHz

Example: Tune from 7.000 MHz to 15.000 MHz to get the correct time from WWV.

- Press the **FAST** key to select fast tuning rate, then press **UP ▲** 8 times to change frequency to 15.000 MHz (audible beeps will confirm your entry), *or* simply press *and hold* the **UP ▲** key, the frequency will begin stepping in 1 MHz increments, release it as 15.000 MHz appears.
- Alternately*, press the **FAST** key, then rotate the main tuning knob clockwise 8 turns (as you approach 15.000 MHz, you may need to slow your turns or switch to the normal tuning rate to arrive at the frequency without slightly over-shooting).

FAST tuning selection provides rapid and coarse tuning over a wide range, and is usually sufficient for most AM wide and FM reception. It can also be used in other modes for rapid frequency changes when pressing of the **UP ▲ DOWN ▼** keys is not desired. In other modes such as SSB, CW and AM narrow, normal tuning provides slower, more precise frequency adjustment.

Display of the 10 Hz Frequency Digit

The FRG-100 normally displays the received frequency to 10 Hz resolution, if you do not want to have the 10 Hz digit read-out, it can be turned off by pressing *and holding* the **DOWN ▼** button while powering on the radio. Repeating this step returns the 10 Hz digit display

The main tuning knob can be used to tune across any part of the receiver's range, but when changing frequency more than 1 MHz, it is sometimes convenient to use the **UP ▲ DOWN ▼** buttons. Experimentation with both methods and your personal preference will determine which is most suitable.

Programmable Tuning Steps

The FRG-100 enables you to independently program **FAST** tuning step *for each mode* from 100 Hz to 100 kHz. This can be especially useful when tuning MF and HF broadcast stations where frequency spacing is pre-determined, or in such radio services where frequencies are "channelized". By entering the appropriate frequency step size, you can tune from channel to channel, or station to station, by-passing the "dead" frequency or "guard" channel in between.

To program the tuning steps, press *and hold* **SET**, then press the **FAST** key. Your display should appear as below, with the selected mode and "SET" indicators flashing.



The number displayed indicates the tuning step increment *in kHz*. By rotating the **MEM DWN**

↔ **UP** control or using the **UP ▲ DOWN ▼** buttons, increments from 0 to 100 kHz can be selected. *Note:* Selecting a step size of 0 kHz will result in no frequency advance as the main tuning knob is turned, therefore please choose a whole increment.

Example: Tune through all 40 AM channels of the Citizens Band (CB) Radio Service.

First select **AM** mode and tune to 26.965 MHz.

Press *and hold* **SET** then **FAST**. Using either the **MEM DWN** ↔ **UP** control or the **UP ▲ DOWN ▼** buttons, select a tuning increment of 10 kHz.

Press **SET** to store the value and return to normal operation.

Select **FAST** tuning rate. *Slowly* tune between 26.965 MHz and 27.510 MHz. Each frequency displayed will be an assigned channel. If the tuning speed is too rapid, it can be *halved* as described on the previous page.

Fast Tuning Key

In the default setting, the **FAST** key and its function is toggled on/off by repeatedly pressing it. Its operation can be changed to a *momentary*-type by turning the radio off, then pressing *and holding* the **FAST** key while powering on again. Now, the **FAST** key/function will only be enabled for as long as it is depressed. "**FAST**" will appear in the display as before, confirming operation. Releasing the button will return to the normal tuning rate.

To return to default operation, repeat the above power-on sequence.

Locking the Main Tuning Dial

To prevent accidentally de-tuning your receiver, pressing the **LOCK** button disables the tuning knob (it still turns, but does nothing). All other controls and buttons are still functional. To disable *all* front panel buttons, press *and hold* **LOCK** while powering on the radio. Press **LOCK** again to free the main tuning knob and other controls.

Signal Reception

AM Broadcast Reception

Most commercial broadcast stations below 30 MHz use AM (Amplitude Modulation). Pressing the **AM/N** mode button once (when switching from another mode), selects the 6-kHz AM wide bandwidth. This gives the highest fidelity, and is best on strong AM signals (and particularly music). For weaker AM signals, or where adjacent channel interference is present, the narrower 2.4-kHz IF bandwidth offers a compromise between interference rejection and fidelity. This can be selected by pressing **AM/N** again ("**NAR**" appears at the top of the display). When tuning a AM broadcast station (and in all modes), use your signal strength meter as a tuning aid. Simply tune for maximum S-meter indication. Tuning speed can be adjusted to your preference as described in the previous chapter. AM broadcast stations can be found throughout the LF, MF and HF spectrum, but there are some bands where broadcasts stations frequently transmit. The FRG-100 has a special *Broadcast Band* selection mode that will aid you in selecting and tuning among these bands.

Broadcast Band Selection Mode

This feature enables you to easily select and tune the following common AM broadcast bands as shown on the chart below.

Meter Band	Recommended Tuning Range (MHz)
LW	0.150 ~ 0.285
MW	0.520 ~ 1.625
120	2.300 ~ 2.495
90	3.200 ~ 3.400
75	3.900 ~ 4.000
60	4.750 ~ 5.200
49	5.850 ~ 6.200
41	7.100 ~ 7.750
31	9.350 ~ 9.900
25	11.550 ~ 12.050
21	13.600 ~ 13.900
19	15.100 ~ 15.700
16	17.550 ~ 17.900
—	18.900 ~ 19.300
13	21.450 ~ 21.850
11	25.670 ~ 26.100

To enable this feature, perform the following steps.

- Ensure normal tuning speed is selected (**FAST** should not appear in the display)
- Press *and hold* **SET** then the **UP ▲** key momentarily (a beep will sound).
- Press the **FAST** key. Subsequently pressing of the **UP ▲ DOWN ▼** keys will now result in *Broadcast Band* stepping rather than frequency stepping as before.

The receiver will display the lower band-edge frequency, feel free to tune around each range (see chart).

If you step to a different band after tuning around in the previous one, the last tuned frequency is saved, and will be displayed upon returning to that band.

- Repeating the first two steps above will return to normal operation.

SSB Reception

Single Sideband (SSB) is a commonly used mode of communication by a variety of services. Such examples include Amateur Radio, Marine Radiotelephone, Citizens Band (CB), Aeronautical and Military communications to name a few. Upper Sideband (USB) is generally the most commonly used mode, however Lower Sideband (LSB) can be found, for example, in Amateur Radio communications below 10 MHz.

From any mode, simply press the **SSB** button for the desired sideband ("**USB**" or "**LSB**" will appear at the top of the display). *Slowly* tune across the signal until the audio becomes understandable. Try switching to LSB and re-tuning if AM and USB modes fail to demodulate what appears to be a voice signal. For fine tuning a SSB signal, normal (10 Hz frequency steps) tuning speed is almost a necessity, **FAST** will get you there in a hurry.

Note: For even better reception of weak AM signals, or those experiencing adjacent channel interference, you can switch to an SSB mode (whichever sideband gives the clearest reception) When first switching to SSB from AM, an annoying heterodyne (tone) will usually be present on the signal, *slowly* fine-tune the signal. for zero-beat (until the pitch of the heterodyne lowers until it is no longer heard), and for best audio clarity. If the interference is still present, try se-

lecting the other sideband, and repeat the tuning procedure. The following table list some *approximate* frequency bands to tune where SSB activity can be found:

Service	Bands (MHz)	
Amateur Radio	1.800 ~ 2.000	3.750 ~ 4.000
	7.150 ~ 7.300	14.150 ~ 14.350
	18.100 ~ 18.200	21.150 ~ 21.350
	24.850 ~ 24.980	28.200 ~ 29.450
Citizens Band	26.960 ~ 27.410 (AM also)	
Aeronautical (USB)	2.850 ~ 3.155	3.400 ~ 3.500
	4.650 ~ 4.750	5.450 ~ 5.730
	6.500 ~ 6.750	8.815 ~ 9.040
	10.005~10.100	11.175~11.400
	13.200~13.360	15.010~15.100
	17.900~18.030	21.870~21.924
	23.200 ~ 23.350	
Maritime (USB)	2.000 ~ 2.100	4.000 ~ 4.450
	6.200 ~ 6.550	8.100 ~ 8.300
	8.700 ~ 8.850	12.300~12.375
	13.000 ~ 13.175	16.350 ~16.550
	17.200 ~ 17.375	22.000 ~22.200
	22.700 ~ 22.850	

Adjusting SSB Carrier Frequency Offset

This allows you to separately adjust the receiver's USB and LSB audio response to your own taste. The carrier offset is adjustable from 452.000 - 458.000 kHz. Factory default offsets are 453.500 kHz for LSB, and 456.500 for USB.

Caution!

Since extreme or incorrect adjustments of this offset can result in distorted or unintelligible receiver audio, regardless of how the station is tuned, we recommend this feature after you have first become familiar with basic receiver functions.

To adjust the SSB carrier offset, perform the following steps.

- Select the desired sideband and tune in a signal of relatively good strength and clarity (USB offset is used in this example).
- Press and hold **SET**, then **MEM CLR** (a short beep will sound).

The display will appear as below.

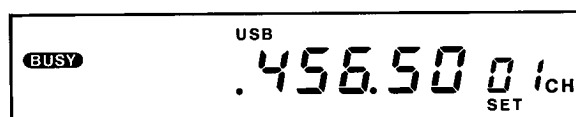

- Slowly rotate the **MEM DWN** ↔ **UP** control while listening to the change in audio response.

As you adjust the carrier offset, it will become necessary to slightly retune your station periodically using the main tuning knob. As you tune the station, the display will show the *carrier offset frequency*, rather than the station frequency.

- Alternately adjust the carrier offset and retune as necessary until the desired audio response is achieved. Adjusting the carrier offset to either extreme will begin to result in unintelligible or distorted audio. If this happens, adjust the offset back towards it's original value.
- Press **SET** to store the new carrier offset setting.

CW (Radiotelegraphy) Reception

CW (Continuous Wave) is popular mainly in the Amateur Radio and Maritime mobile bands, where its ability to be understood under conditions of fading and interference is advantageous over other modes. The FRG-100 has the option for installation of a 250 Hz or 500 Hz narrow CW filter that will permit enhanced reception of signals in crowded band conditions, or when experiencing interference. Please note that only *one* optional crystal filter can be installed at a time. See the *Installing Internal Accessories* chapter for instructions.

From any mode, press the **CW/N** key ("**CW**" will appear at the top of the display), press once again if the the optional 250 Hz or 500 Hz narrow filter is desired, "**NAR**" will appear in the upper right of the display. Tuning for CW is similar to that of SSB, with the slow tuning rate being preferable. When tuning with the narrow filter selected, slowly roll across the signal until you arrive at a frequency where the signal audio seems to "peak". This should greatly reduce interference from adjacent signals, while providing a readable CW signal.

Adjusting BFO "Beat Note"

In CW mode, the receiver's BFO (Beat Frequency Oscillator) frequency is offset with respect to the center-frequency of the receiver's IF filter. The BFO offset determines the pitch of the audio tone that you will hear *and* the frequency that the IF center frequency and display will be offset from the true carrier frequency of a signal during CW reception. From the factory, the default BFO offset is 600 Hz, however, it may be adjusted to 400, 500, or 700 Hz if you prefer a different pitch. If you are comfortable with the 600 Hz offset, you may leave it as set.

To adjust the BFO offset *from the CW mode*:

- Press and hold **SET** then **VFO►MEM** (a short beep will sound). The display will appear as below.

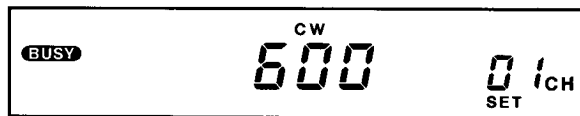

- Using either the **MEM DWN ↔ UP** control or the **UP ▲ DOWN ▼** keys, select a BFO offset.
- Press **SET** to save your selection and return to CW reception.

Amateur Radio CW Bands

1.800 ~ 2.000 MHz	3.500 ~ 3.750 MHz
7.000 ~ 7.150 MHz	10.100 ~ 10.150 MHz
14.000 ~ 14.150 MHz	18.068 ~ 18.100 MHz
21.000 ~ 21.120 MHz	24.890 ~ 24.930 MHz
28.000 ~ 28.100 MHz	

Selectable CW Sideband

It is possible to receive USB voice signals using the CW mode in some radios, but not LSB. This is because the CW BFO offset is normally the same as that of USB. You can observe this by tuning a CW signal, then switching between USB and CW. You will notice no apparent difference in the received signal.

However, if you tune to a signal and then change modes between CW *and* LSB, the signal will be lost and require slight re-tuning. This is the result of a difference in receiver BFO offset between these respective modes. Re-tuning can be inconvenient, especially if you enjoy working bands where both CW and LSB modes are used adjacent to each other (such as the 40, 80, & 160-meter Amateur Radio bands).

For added operating convenience, the FRG-100 permits matching the CW offset to the *alternate* sideband (LSB), as well as USB (default) whenever the **CW** key is pressed. This is illustrated in the graph below.

Using this feature, you may freely tune LSB voice and CW signals *from within the same mode*,

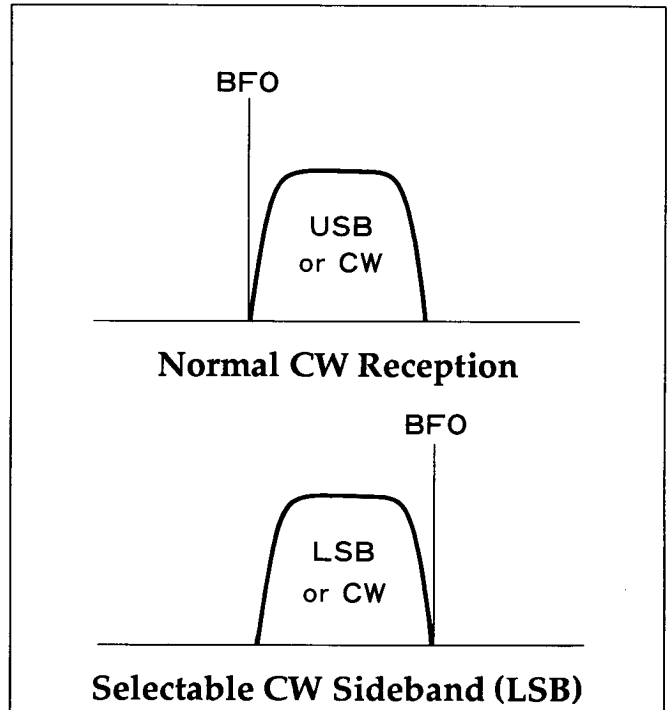

and even select the narrow CW filter (if installed) *without having to change modes and re-tune your desired signal*. Normal USB and LSB reception is still possible as before, however, when in CW mode, the selected CW sideband offset will automatically take effect.

Example: Select CW (LSB) offset.

- Press *and hold* the **CW/N** key while turning on the radio. At this point, *normal* SSB reception can be selected just as before by toggling the **SSB** button for the desired sideband.
- To match the CW offset to the alternate (LSB) sideband, select LSB using the **SSB** key, then simply press **CW/N**. Notice that *both* "LSB" and "CW" appear above the frequency display to let you know which offset you have selected.

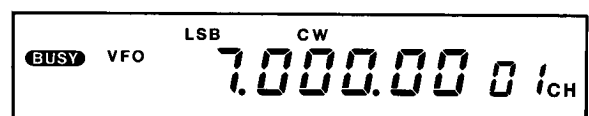

Offset can be verified by tuning to a LSB voice signal, then switching between LSB and CW (LSB-offset) modes. Notice that the voice signal can now be received in CW mode, and that re-tuning is not required.

- To return to the USB offset, toggle the **SSB** key until "**USB**" appears alone, then press **CW/N**. The display will now show "**CW**" with your selected (USB) offset

To disable the CW Carrier Offset feature, turn off the radio, then once again press *and hold* the **CW/N** key while powering on the radio.

Reverse BFO Offset

Normal CW operation places the BFO frequency offset *below* the IF center-frequency. However, this offset can be switched to *above*. If you are experiencing interference from a adjacent signal that cannot be eliminated by de-tuning, this feature may help alleviate the problem. In some cases, the offset will place the troublesome signal far enough outside the previous receiver passband to eliminate (or reduce) the interference. The following illustration shows how shifting the BFO offset can avoid interference.

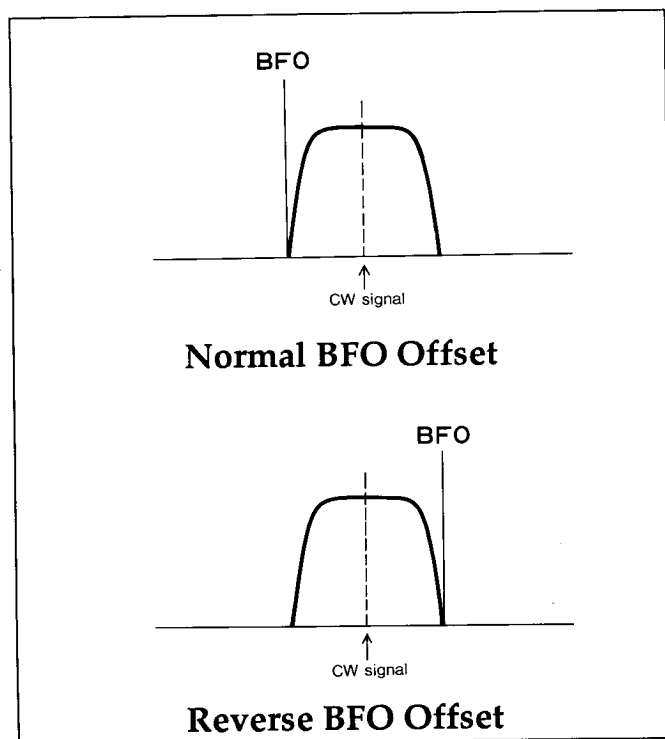

The Reverse BFO Offset can only be enabled from within the Selectable CW Sideband mode previously explained. If you are tuned to a CW signal receiving interference, perform the following steps.

- Press *and hold* the **SET** key, then press the **CW** key to reverse the offset as shown below (the "**LSB/USB**" indicators will change to reflect the reversal).

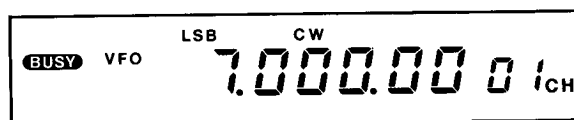

You will notice the pitch of your original signal change (the display frequency, however, will remain the same).

- Slightly re-tune the desired signal for best reception. The BFO offset can be toggled back to its original setting by repeating the above key sequence.

Important!

While the display indications for both the Selectable CW Sideband and the Reverse BFO Offset appear similar, it is important to note that these are **two separate functions**. The Selectable CW Sideband is primarily an operating convenience for reception in certain Amateur Radio bands, while the Reverse BFO Offset is designed to reduce interference experienced primarily on CW signals.

FM Reception

FM (Frequency Modulation) is not widely used below 30 MHz, however, Amateur Radio communications can occasionally be heard between 29.510 - 29.700 MHz, some FM-mode CB transceivers (usually hand-held type) in the 27 MHz band can also be found. FM reception is made possible with the installation of the optional FM UNIT-100 unit. Please see the *Installing Internal Accessories* chapter for details.

- FM reception can be selected from any mode by pressing the **FM** key ("**FM**" will appear at the top of the display). You will immediately notice an audio "rushing" noise from the receiver, this is normal. Slowly rotate the **SQL** control clockwise until the noise quiets, and "**BUSY**" indicator disappears at the left of the display.

When in the FM mode, tune the received signal for maximum S-meter deflection, clearest audio, and maximum receiver "quieting".

Receiver Squelch Setting

The squelch setting is very important and affects signal reception. By rotating the **SQL** control clockwise *past* the point where the receiver initially "quiets", the stronger the required signal that will be needed to "open" it. Adjusting the **SQL** control beyond this point will limit your reception to only those stations which have fairly strong signal levels and are generally nearby, however, band propagation conditions can often result in DX (long distance) reception.

Generally, an optimum **SQL** setting is such that the receiver remains quiet from band and spurious noise, but opens to permit listening to signals that are of sufficient strength to be intelligible. While tuning around, if you notice S-meter deflections without any signal being heard or hear broken audio, this is a possible indication that your **SQL** control might be adjusted too far.

Fading and Noise Rejection

Distant received stations can sometimes distort while undergoing extreme signal strength fluctuations due to sources such as ionospheric and propagation phenomena. This is visible by observing the S-meter variation while tuned to a broadcast. In addition, rapidly tuning from weak to strong signals can have a similar effect.

AGC (Automatic Gain Control) circuitry is designed to counteract this problem and maintain a relatively constant audio level, even during extreme fading conditions. The AGC has two settings, fast and slow. This refers to the recovery rate of the receiver to signal strength variations.

In most cases when when tuning around for stations, the **AGC-F** button is usually selected (depressed), to allow receiver gain to recover quickly after tuning past strong signals. Once you have a signal tuned in, unless it is very weak, you will probably find reception better with the **AGC-F** key off (un-depressed).

Noise Blanker Setting

The noise blanker circuit in the FRG-100 can sometimes provide effective reduction in static and pulse-type interference. This is commonly encountered from automobile ignition systems, electrical motors, and from natural sources such as thunder storms. If you hear pulse noise, just press the **NB** button. If no interference is being experienced, or if the noise blanker tends to distort the received audio, it should be left off (un-depressed).

RF Attenuation

Interference can be experienced from receiver front-end overloading caused by a very strong signal from a nearby station. This can be reduced by inserting an appropriate amount of RF attenuation, so that the annoying signal is reduced to a level where the desired signal can be effectively received.

In the FRG-100, *three* attenuation levels can be inserted, 6 dB, 12 dB, or 18 dB (by selecting both). When receiving a strong signal, select different attenuation levels by pressing the **6dB** and/or **12dB** keys until the desired attenuation is obtained. When changing modes or tuning afterwards, remember to turn off the attenuation.

Beep Settings

Normally, pressing any of the front panel push-buttons will result in an audible "beep" confirming your entry.

The beep tone is adjustable from 270 Hz to 3520 Hz if you prefer a different pitch than the default setting (880 Hz). The beep can be disabled completely for silent operation. To adjust the beep tone, perform the following steps.

- From any mode, press *and hold* **SET**, then **VFO/MEM** key momentarily. The display will appear as below, with a constant beep tone.

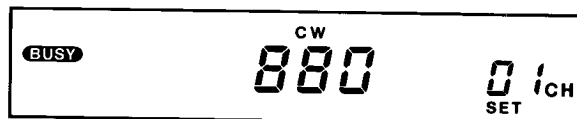

- Rotate the **MEM DWN** ↔ **UP** control until the desired tone is reached, then press **SET** to save your new "beep". The display will return to the previous mode.
- To disable the beep tone, repeat the first step as above, then press **SEL**. The tone will stop and the display will appear as below.

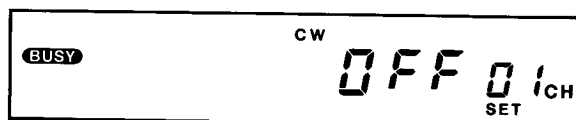

- Toggling the **SEL** key will alternately turn the beep on/off.
- Press **SET** to return to normal operation.

Beep Volume

Beep volume is *not* affected by the front panel **VOL** knob, but can be adjusted by a control located beneath the top cover of the receiver. Instructions on removing the receiver cover and adjustment are covered in the *Installing Internal Accessories* chapter.

Changing Receiver Selectivity

The FRG-100's IF bandwidth (selectivity) is automatically selected according to the reception mode, as shown below.

Mode	Default IF Selectivity
CW Narrow (optional)	500 / 250 Hz
SSB, CW	2.4 kHz
AM Narrow	4.0 kHz
AM	6.0 kHz
FM (optional)	15.0 kHz

In AM and CW modes, you can change the normal selectivity by manually inserting a narrow filter (optional for CW). These bandwidths are generally considered optimum for their respective modes. However, the default bandwidth settings for AM & SSB modes can be changed if you so desire for special applications. CW only has the normal and Narrow setting, while FM is fixed at 15 kHz. In general, narrowing receiver bandwidth can reduce interference from adjacent signals at the expense of audio fidelity. This is better demonstrated than explained.

Select the **AM** mode, then tune to a strong local AM broadcast station.

- Hold the **SET** button, then press **SEL**. Your display will appear as below. This indicates the present (default) mode IF filter (bandwidth) selection.

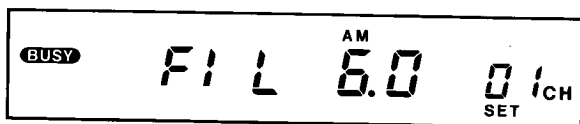

- Rotating the **MEM UP** ↔ **DWN** control will change the default selectivity from 6.0 to 4.0, 2.7 or 0.5 kHz. AM broadcast audio can usually be understood with as narrow as 2.7 kHz of bandwidth, however, notice the effect on

the audio quality. Return the setting to 6.0 kHz.

Note! "**FIL 0.5**" will be displayed *regardless* of which optional filter (if any) is installed. Actual selectivity (250 or 500 Hz) will be determined by the installed filter, in addition, "**2.7**" actually indicates a selectivity of 2.4 kHz.

- To save the default IF filter selection, press **SET**. Your display will return to the tuned frequency. In this way, the default bandwidth settings for each mode can be changed.

Caution!

While it is versatile in special circumstances to be able to change the receiver's bandwidth settings, we recommend leaving the default settings as they are.

PLL Offset

The PLL Offset adjusts the frequency of the receiver 1st Local Oscillator, and permits fine tuning adjustments of ± 3.00 kHz. This can be used to zero-beat your receiver against a known frequency standard. *However, your receiver comes fully calibrated and aligned from the factory, and under most operating situations, requires no further adjustment.* This feature is only mentioned to inform you of its existence, or in the event that it is accidentally selected, we *do not* recommend altering the offset.

- The PLL offset is selected from any mode by holding the **SET** button, then pressing **MEM▶ VFO**. Your display will appear as below. This indicates the current default PLL Offset (0.00) in kHz.

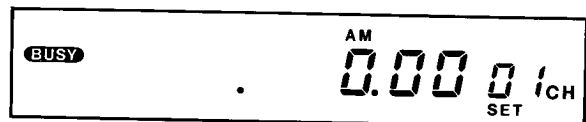

- If adjustment should ever become necessary, select the appropriate mode, then tune to the published frequency of a known station (such as WWV). Press **LOCK**.
- Rotate the **MEM UP** ↔ **DWN** control to adjust the offset in 10 Hz steps (± 3.00 kHz) to zero-beat the receiver against the known station's frequency.
- Press **SET** to save the new offset and **LOCK** again return to normal operation.

Memory Operation

Introduction

The 52 memories in the FRG-100, labeled 01 through 50, Lo and Hi, each store frequency, mode, and narrow filter selections (for CW and AM modes). When you recall a memory, these operating parameters are displayed. These can be used to store your favorite station frequencies for convenient recall, listening and scanning. Memories Lo and Hi store band-edge information used when searching within a band for new signals (memory and band scan operation is covered in the next chapter).

Memory Storage

To store a displayed frequency into memory simply press *and hold* the yellow-labeled **VFO ► M** button for longer than 1/2 second. Memory channels Lo, Hi, and 01 contain default frequencies of .150.00 MHz, 30.000.00 MHz, and 7.000.00 MHz respectively and can be re-programmed at any time. Let's begin with a simple example of storing a displayed frequency into a memory channel.

Example: Store 2.182 MHz from VFO into memory channel 10.

- First press **VFO/M** to select VFO operation ("VFO" will appear at the left of the display), select USB mode, then tune to the desired frequency (2.1820.00).
- Next, press **VFO/MEM** again to select memory operation ("MEM" will appear at the left of the display).
- Rotate the **MEM DWN ↔ UP** control to select a memory channel (channel 10 in this example). The memory channel number selected will be displayed at the far right. *Note:* ensure that **FAST** is not enabled as this only permits recalling previously programmed memory channels.
- Now press *and hold* the **VFO ► M** button for longer than 1/2-second. Two beeps sound to confirm the memory was stored. The display will now show the memorized frequency.

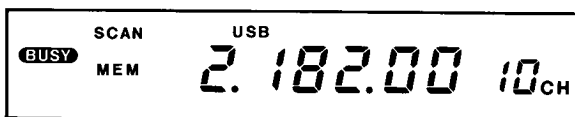

- To return to VFO tuning, press **VFO/MEM**.

Checking Memory Contents

Before storing or recalling a memory, you will usually want to check its contents. From the VFO mode, press **VFO/MEM** for memory operation and use the **MEM DWN ↔ UP** control to browse through the channels, or, without leaving the VFO mode, simply rotate the **MEM DWN ↔ UP** control (if you don't mind the blinking display). Using either method, both programmed and empty memory channels will be displayed. If you wish to skip over empty memory channels when browsing, press the **FAST** key, then only programmed memories can be recalled and displayed.

Checking and Programming Memories From VFO Mode

You may find that checking and programming memories directly from the VFO mode more convenient than performing the keystroke sequence previously described. After tuning the desired frequency on the VFO, select the memory channel you wish to store it in by simply rotating the **MEM DWN ↔ UP** control. As soon as you do this, the frequency display, mode indicator, "MEM" and channel number will begin blinking, and will continue to for 3 seconds, after which the display will return to the VFO frequency if no further controls are touched. This is normal, and alerts you that you are checking memories while still in the VFO mode.

The frequency read-out on the LCD will be blank if the memory is vacant, or display its contents if programmed. As you rotate the **MEM DWN ↔ UP** control, the corresponding memory channel will be shown (as the display continues to flash). Press **VFO ► M** for longer than 1/2

Auto Memory Arrangement

Memorized frequencies can be automatically arranged in channel number order ascending from lowest to highest frequency, starting with memory channel 01. To do this, turn off the radio, then press *and hold* the **MEM ► VFO** key while turning on the power. Previous frequencies will be rearranged in order, any vacant memory channels will be filled.

second to store your frequency in the selected memory channel.

Erasing a Memory Channel

You can re-program a memory channel at any time, however, if you want to erase its contents completely, simply press the **MEM CLEAR** key when the desired memory channel is selected. *Note:* Memory channel 01 *cannot* be erased. The frequency display will then blank, indicating that no frequency information has been programmed. The channel can then be skipped during memory selection, and during memory scanning (to be covered later). If you change your mind, and wish to restore the old frequency, pressing **MEM CLEAR** again will restore the last active memory. This can be used for each memory channel.

Clearing All Memories

If you wish to erase *all* of the memorized data, perform the following step. Please note, however, this clears all clock/timer settings, as well as frequency data.

Turn the radio off, press *and hold* **MEM CLEAR** while powering on again. The radio is now reset to the factory default settings.

Memory Tuning

All 52 memories in the FRG-100 are tunable, similar to VFO operation, without changing their stored frequency. When a memory channel is selected, it can be tuned by simply rotating the main VFO knob or other stepping keys. On your display, the "**MEM**" and "**SCAN**" indicators will immediately disappear, as the "**M-TUNE**" indicator appears.

The memory will tune within the full range of the receiver. This new tuned memory frequency can be written over the previous one by pressing the **VFO** key for 1/2 second until the double beep sounds. To return to the memory channel, press **VFO/MEM**, once again to return to VFO operation.

Writing Memory Contents to VFO

The contents of a selected memory channel or tuned memory can be copied directly to the VFO. This is sometimes useful for further tuning and eventual copy to a new memory channel.

Holding the **M ► VFO** button for 1/2 second copies the current memory channel data or the tuned memory frequency into the VFO.

Scanning Operation

Introduction

Scanning operation enables you to check activity on memory channels, or search bands for new stations. The FRG-100 offers several flexible scanning modes; Memory, Band, Priority and Group Scanning. While in memory operation, pressing the **SCAN SEL** key toggles between scanning modes, with indication in the lower right corner of the display showing the mode selected (as shown below). Each mode offers *two* choices of scan resume; *time*-delay or *carrier*-delay.



Memory Scan

This mode sequentially checks for activity on all or only selected memory channels. Vacant memory channels are automatically skipped. Scanning stops on any channel having a signal strong enough to open the squelch, the two decimal points in the frequency display will blink while scanning is stopped.



By default, *carrier*-delay operation is selected and scanning resumes 2 seconds after no signal is present. Alternatively, you can select *time*-delay operation and have scanning resume automatically after 5 seconds, even with activity present. Carrier-delay operation requires the squelch to be closed to mute background noise and allow scanning, however, in time-delay operation, scanning will automatically step to the next channel after a 5-second delay. This mode is useful if you want to step through all of the memories to "sample" the activity on, each, or listen to signals not strong enough to open the squelch.

To toggle between carrier-delay and time-delay operation, turn off the receiver and turn it on again while holding the **SEL** button. As you press *and hold* this key with the power off, you

will notice the single digit at the right side of the display shift from "1" to "2". This indicates default (1) or alternate (2) selection..

Example #1: begin scanning all memory channels (*default* carrier-delay).

- Press **VFO/M** to select memory mode.
- Adjust the **SQL** control until the receiver quiets and "**BUSY**" indicator disappears.
- Press the **SCAN** key to begin memory scanning. The frequency display and memory channel number will begin changing in memory sequence.

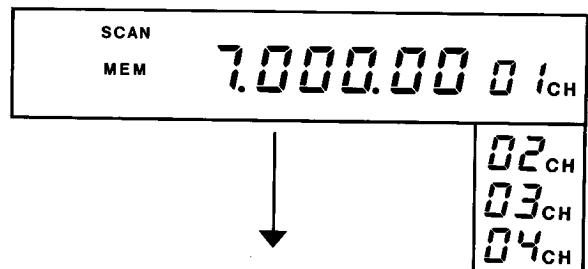

- To stop scanning, press **SCAN** again.

Note: You may need to readjust the **SQL** control to prevent scanning from stopping on only background noise.

When activity is found, scanning stops to that channel, the "**BUSY**" indicator comes on, and the decimal points in the display will begin flashing. As activity ceases, scanning will resume 2 seconds later.

Example #2: Scan all memories (*alternate* time-delay).

- Turn the radio off. Press *and hold* the **SEL** key while powering back on (note the display digit change from "1" to "2" before powering on).

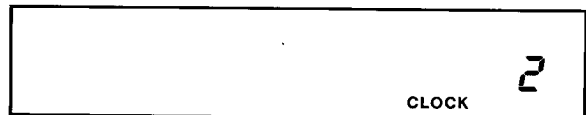

- Repeat the procedure as above to begin scanning.

When activity is found, the display will have the same indications as above, however, scanning will resume 5 seconds after activity is found.

Note: If you wish to "sample" all of the memory channels (activity or not), simply rotate the

SQL control fully CCW to open the squelch. Each memory channel will be sampled for 5 seconds.

Scan Stop

Scanning operation normally resumes after a signal ceases, or at five second intervals, depending on the delay selected (time or carrier). If you want the receiver to stop *and remain* on a channel or frequency where activity was detected, turn the radio off, then press *and hold* **SCAN** while turning it on again. Scanning operation is selected and started as before, but now scanning will stop on the first activity found, but will not resume until the **SCAN** button is pressed again. Repeat the above power-on sequence to return to default operation.

Memory Scan Skip

If you have stored many memories, you may not want to scan all of them. You can select some of them to be skipped during scanning. First, recall the memory to be skipped, press *and hold* **SET**, then **SCAN** together momentarily. A single beep will sound, and the "SCAN" indicator will disappear as shown below. Repeating the sequence will enable the channel for scanning again.



Band Scanning: Band-Edge Memories Lo & Hi

The FRG-100 does not limit you to only scanning memory channels. You can use the band scanning mode to search for any activity between two frequencies. This could be a band allocation, such as the 20-meter amateur band, the entire range of the receiver, or between any two arbitrary frequencies you want to explore.

This feature makes special use of programmable band-edge memory channels Lo and Hi (selected been memory channels 50 and 01). These are used exclusively for band scanning, and are not displayed or even selectable in the memory scan mode. Their contents determine the upper and lower frequency limits that will be scanned between.

Before beginning band scan operation, you must first program band-edge memory channels Lo and Hi with the upper and lower frequency limits of your choice (factory default frequencies of .150.00 MHz and 30.000.00 MHz are memorized in Lo and Hi, respectively). These memories are recalled and programmed in the same manner as channels 01 - 50 (See. *Memory Operation*).

Band scanning is started by simply recalling either the low or high band-edge memory channel, closing the squelch, and then pressing the **SCAN** key. The receiver will begin scanning between the Lo and Hi limits. If the Lo memory was initially selected the receiver will start scanning from low to high, or vice-versa if Hi was initially selected. If you let scanning continue indefinitely, it will loop around when it reaches the Lo or Hi limit.

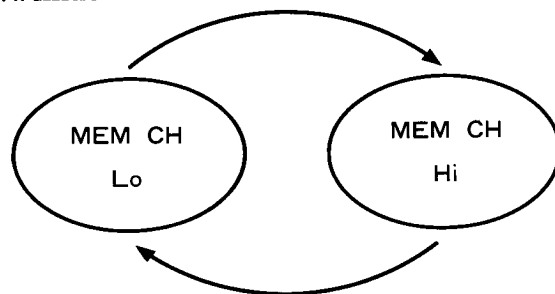

The scan rate will be determined by the step size for mode selected (see chart on page 13). You can increase the scanning step size by 10, by pressing the **FAST** button while scanning. Band scanning operates in carrier (default) or time delay and can be toggled in the same manner as memory scanning mode.

Example: Scan the 15-Meter Amateur Band for activity.

- From VFO mode, select USB and tune to the low edge of the 15-meter amateur band. (21.000.00 MHz).
- Recall memory channel Lo, then memorize the VFO frequency into it.
- Tune to the upper edge of the 15-meter amateur band (21.350.00 MHz).
- Recall memory channel Hi, and memorize this VFO frequency into it.
- With either memory channel Lo or Hi selected, rotate the **SQL** control until the squelch closes, then press **SCAN** to begin band scanning.

The receiver will begin scanning up or down in frequency (depending on which band-edge channel you selected). If you prefer a faster or slower scan speed, press the **FAST** button to

toggle the tuning step size. When activity is detected, scanning will stop on that frequency, then resume *according to the delay mode selected* (time or carrier).

Priority Scan

Priority Scan is useful for “keeping watch” on a frequency of interest (such as an emergency or hailing frequency), while still being free to tune around or listen elsewhere. Any *single* memory channel (except Hi and Lo) can be tagged as the priority channel.

While receiving in VFO or Memory mode, the priority channel will be automatically checked once every 5 seconds for activity. As this happens, your frequency display will momentarily revert to the priority channel, and then return to normal. If activity is received during a scan, the radio will automatically switch to the priority channel for monitoring. In the default (carrier delay) mode, operation will resume to the previous VFO or memory channel 2 seconds after signal activity ceases. In the alternate (time-delay) mode, the priority channel will be monitored for 5 seconds, then operation returns to the previous VFO frequency or memory channel regardless if activity continues on the priority channel (it will be caught on the next scan). Carrier and Time Delay modes can be toggled using the power-on sequence as described before (See: *Memory scan*).

To tag a selected memory channel as the priority channel, press **SCAN SEL** until “**PRI**” appears above the memory channel number at the right side of the display. Then, from either memory or VFO operation, simply pressing **SCAN** will begin priority scanning.

Example: Priority scan memory channel 10 while in VFO operation.

- Press **VFO/MEM** to select memory operation, then recall channel 10.
- Press **SCAN SEL** until “**PRI**” appears above the memory channel number.

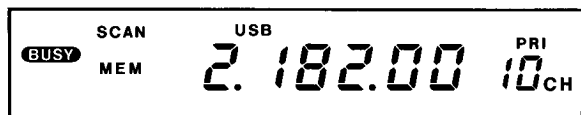

- Press **VFO/MEM** to return to VFO operation, then press **SCAN**.

Priority scan will now begin, you are still free to tune as before.

Selectable Group Scan

This versatile scanning mode allows you to scan memory channels by an assigned group or pattern. In *Memory Scan*, all fifty memory channels are sequentially scanned, any channels that you do not want to scan must be individually de-selected or “locked-out”. This can be inconvenient, especially if there are multiple channels you wish to lock out, but later want to quickly select again for scanning.

Selectable Group Scanning allows you to arrange your 50 memory channels into 5 groups each containing 10 channels. Each memory channel is given an *alphanumeric* designation (such as **A5**, **E7**, etc.). The *letter* refers to the *group* that it belongs to, while the *number* refers to the channel *within each respective letter group*. Any single selected group (ten channels) can be scanned, or a common channel number among all groups (five channels) can be scanned. Groups and channels can be arranged according to mode, band, or any significance you choose. The chart below illustrates how the memories are arranged by letter-group and channel-number.

Memory Channels	Letter Group - Channel Number									
01 ~ 10	A1	A2	A3	A4	A5	A6	A7	A8	A9	A0
11 ~ 20	B1	B2	B3	B4	B5	B6	B7	B8	B9	B0
21 ~ 30	C1	C2	C3	C4	C5	C6	C7	C8	C9	C0
31 ~ 40	D1	D2	D3	D4	D5	D6	D7	D8	D9	D0
41 ~ 50	E1	E2	E3	E4	E5	E6	E7	E8	E9	E0

There are two options in this mode, scanning by common *letter group* or common *channel number*. This is visually simplified in the above chart if you think of group scanning as *horizontal* scanning, and common channel scanning as *vertical* scanning.

Memory Usage

Please note that the common fifty memory channels are used in both Memory and Group Scanning modes, only the assignment is different. Memory channel 42 would have an assignment of “E2” (group “E”, channel “2”) in Selectable Group Scanning mode, but the memorized frequency contained within would be the same in both modes.

Common Group Channel Scan

This feature enables you to select a common channel number among all letter groups for scanning (5 channels), and is the default mode. This can be thought of as "vertical" scanning, and is illustrated in the table below.

Memory Channels	Letter Group - Channel Number									
01 ~ 10	A1	A2	A3	A4	A5	A6	A7	A8	A9	A0
11 ~ 20	B1	B2	B3	B4	B5	B6	B7	B8	B9	B0
21 ~ 30	C1	C2	C3	C4	C5	C6	C7	C8	C9	C0
31 ~ 40	D1	D2	D3	D4	D5	D6	D7	D8	D9	D0
41 ~ 50	E1	E2	E3	E4	E5	E6	E7	E8	E9	E0

This can be selected from the Memory mode by toggling the **SCAN SEL** button until an alpha numeric indication appears in the memory channel window. The common channel number can be selected from within any of the letter groups. For example, if you want to scan channel 6 in all the letter groups, selecting A6, B6, C6, D6, or E6 would all result in the same scan pattern. Then, rotate the **MEM DWN ↔ UP** knob to select a common channel number for scanning. Close the **SQL** control, the press **SCAN** to begin.

Example: Scan channel 9 in all letter groups.

- From memory mode, press **SCAN SEL** until an alphanumeric display appears in your memory channel window similar to below (our display might have a different letter group, but this is not important).

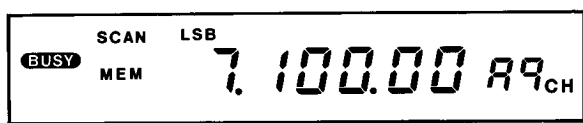

- Rotate the **MEM DWN ↔ UP** knob until the number "9" appears next to the right of any letter.
- Close the **SQL** so that the receiver quiets, and the "BUSY" indicator goes off. Press **SCAN** to start.

Note!

Default and selectable scanning functions such as time and carrier-delay, and scan stop, can be used in the Group Scanning Mode as well as normal memory channel scanning. They are selected using the same power-up and key sequences previously described.

Common Letter Group Scan

This alternate mode scans all of the memory channels within any single letter group (10 channels). It can be thought of as "horizontal" scanning, as illustrated below.

Memory Channels	Letter Group - Channel Number									
01 ~ 10	A1	A2	A3	A4	A5	A6	A7	A8	A9	A0
11 ~ 20	B1	B2	B3	B4	B5	B6	B7	B8	B9	B0
21 ~ 30	C1	C2	C3	C4	C5	C6	C7	C8	C9	C0
31 ~ 40	D1	D2	D3	D4	D5	D6	D7	D8	D9	D0
41 ~ 50	E1	E2	E3	E4	E5	E6	E7	E8	E9	E0

This alternate scanning pattern can be selected by pressing *and holding* the **SCAN SEL** key while powering on the radio. From the Memory Mode toggle the **SCAN SEL** button (as before) until an alphanumeric display appears in the memory channel window. Then rotate the **MEM DWN ↔ UP** control to select the letter group you want to scan. In this case, selecting any channel number *within the letter group* you want will result in that group being scanned. For example, selecting A1 - A0 would all result in group-A being scanned. Ensure the **SQL** control is closed, and press **SCAN** to begin.

Example: Scan Group D for activity.

- From memory mode, press **SCAN SEL** until an alphanumeric display appears in your memory channel window similar to below (our display might have a different letter group, but this is not important).

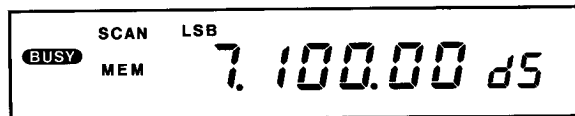

- Rotate the **MEM DWN ↔ UP** knob until the letter "D" appears next to the left of any channel number.
- Close the **SQL** so that the receiver quiets, and the "BUSY" indicator goes off. Press **SCAN** to start.

Using Selectable Group Scanning

The key to obtaining the most from Group Scanning is to arranging your 50 memory channels into some logical order or pattern. This could be grouping them by location, mode, frequency band, or any significance you choose. As

mentioned before, the fifty memory channels are common and used by both Memory and Group Scanning Modes. Therefore, the order that you program them in initially will determine their location or "address" in the Group structure. Of course, they can be re-arranged or programmed later, but it might save you some time to plan ahead.

For example, many shortwave AM broadcast Stations transmit simultaneously on several meter bands. By arranging meter bands by letter-groups (vertically) and station origin by channel number (horizontally) you could selectively scan different stations on a common broadcast band, or scan a common station over several of its transmission bands for the best signal quality. This is useful when certain bands provide the best reception during a particular time of the day or location, or if you want to scan a particular station for the best signal. The example below might help you get started with your own ideas.

Channel No. ⇒ Group Letter ↓	1	2	3	4
A	BBC London 49 meters	Radio Moscow 49 meters	Voice of America 49 meters	WWV 2.5 MHz
B	BBC London 41 meters	Radio Moscow 41 meters	Voice of America 41 meters	WWV 5.0 MHz
C	BBC London 31 meters	Radio Moscow 31 meters	Voice of America 31 meters	WWV 10.0 MHz
D	BBC London 25 meters	Radio Moscow 25 meters	Voice of America 25 meters	WWV 15.0 MHz
E	BBC London 19 meters	Radio Moscow 19 meters	Voice of America 19 meters	WWV 20.0 MHz

Broadcast Band Scanning

You can scan any of the 16 pre-programmed AM broadcast bands previously described in the *Signal Reception* chapter. Refer to the chart in that chapter for each band's frequency range.

The selected band will be scanned within it's upper and lower limits for activity. Scan resume and delay function are selectable the same way as for other scan modes. To begin AM Broadcast Band Scanning, perform the following steps (some of these steps are duplicated in the *Signal Reception* chapter).

First, enable Broadcast Band Selection;

- Ensure normal tuning speed is selected (**FAST** should not appear in the display)
- Press *and hold* **SET** then the **UP ▲** key momentarily (a beep will sound).
- Press the **FAST** key. Subsequent pressing of the **UP ▲ DOWN ▼** keys will now result in *Broadcast Band* stepping rather than frequency stepping as before.

Select AM and then a band to be scanned (the receiver will display the lower band-edge frequency).

- Close the **SQL** control until the "**BUSY**" indicator disappears, the press **SCAN** to begin.

Scan operation is similar to normal band scanning, except that the upper and lower band limits are pre-programmed, rather than defined by memory channels Lo & Hi.

"Birdies"

Some spurious signals or "birdies" are generated from inside your receiver, and can be heard while tuning through various ranges. They usually appear as a steady carrier always found *at the same frequency*. There is no need to worry, as this is not an indication that your receiver is malfunctioning. Actually, these signals are experienced to some extent in all communications receivers. Most birdies are so well suppressed, you won't even notice them while tuning, however, you may find ones around 455 kHz, 10.485 MHz, 12.288 MHz and 22.700 MHz. These frequencies are related to those used by the CPU and other circuits in your FRG-100.

You can determine if a suspected signal is a birdie by disconnecting your receiving antenna, pressing both **ATT** buttons, and listening. If the signal is still present, chances are it's a birdie and you might want to log it for future reference. If the signal disappears, you might be tuned to a commercial RTTY or FAX broadcast station in idle (they often do this for hours on end).

Clock & Timer Operation

The FRG-100 has two independently programmable clocks. One can be set to local time, the other can be adjusted to GMT, UTC or any time zone you desire. A handy World Time Zone reference card is included with your radio, showing international time on one side, and contains a receiver key/function reference on the other. It is located in a convenient slide-out slot on the bottom panel of the receiver. Each clock can be set for 12/24 hour display format. In addition, an hourly beep annunciator (similar to that heard on broadcast and news stations) can be set remind you of the time, every hour, on-the-hour.

To set the clocks, perform the following steps.

- From any mode, press *and hold* the **CLOCK** button for longer than 1/2 second. Clock #1 will be selected, and the display will change to a time and begin blinking. "**CLOCK SET**" and "1" will appear in the memory channel window.

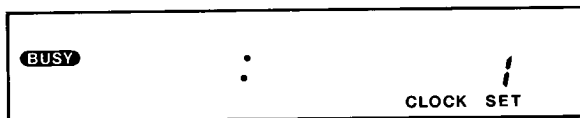

- Using the tuning knob, or **UP ▲ DOWN ▼** keys, adjust clock #1 for the correct time, the display will stop blinking momentarily. The time will advance in 1 minute steps, however, by pressing the **FAST** key, you can toggle to 1 hour steps.
- Press **SEL** to select clock # 2, and adjust it for the correct time.
- When the correct time has been reached for both clocks, pressing **SET** will save the settings and begin time-keeping. The display will revert back to the last VFO or memory frequency. Note: you can press the **SET** key while listening to a time station such as WWV in the background and synchronize your FRG-100's clock with the station's time.

To display the time from VFO or Memory operation, momentarily press **CLOCK**, and then **SEL** to choose which time you want to view (**SEL** will also toggle the display when the radio is turned Off). Tuning is still possible, however, the display will remain on the selected clock (even if you turn off the radio and power-on again) until you press either **VFO/MEM** or **CLOCK** to return to previous operation.

12/24 Hour Format

Clock displays are normally in 24-hour format, however, this can be changed to 12-hour format by pressing *and holding* the **CLOCK** key while powering on the radio. The time display will be accompanied on the right by an "A" or "P" to designate A.M. or P.M. (see below).

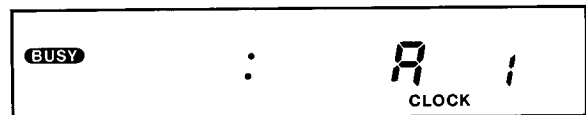

Repeat the power-on sequence to return to 24 hour format.

Default Display

The FRG-100 normally displays the received frequency until some other feature (such as a clock or programming function) is selected, then is returned to normal. This default setting can be changed so that *a selected clock* will normally be displayed if no other controls are touched. Tuning (using the main knob or **UP ▲ DOWN ▼** key) or selecting a new mode will cause the display to *momentarily* revert to the frequency, after which it will return to the clock display.

To select the *alternate* default display, press *and hold* the **VFO/MEM** key while turning on the radio, then select the time you wish displayed by pressing **CLOCK** (and **SEL**).

To return to the normal display, repeat the above step.

LCD Backlighting

With the radio turned OFF, the LCD backlight can be turned on momentarily by pressing the **DIM** button. The LCD will illuminate for approximately 4 seconds, then go off. It's brightness is determined by the **DIM** button setting when the radio was turned on. If you want *continuous* LCD backlighting, press *and hold* the **DIM** key while powering on the radio. Afterwards, when the **DIM** key is pressed with the radio turned off, the backlight will stay on continuously (until **DIM** is pressed again to turn it off).

Hourly Time Annunciator

The FRG-100 can be set to emit a series of beeps (2-short, 1-long) at the top of every hour. This sounds similar to that heard on broadcast and news station. When enabled, it will sound with the radio turned on *or off*.

- To enable this feature, press *and hold* the **TIMER** key while powering on the radio. Repeat this step to return to the original (default) setting.

Timer and Sleep Functions

You can set your FRG-100 to automatically turn on and off at pre-set times. This is convenient if you want to tape record a broadcast while you are out, or wake up to your favorite station every morning. The sleep timer can be set for up to 2 hours if you want to doze off listening to the radio.

Timer programming actually involves two *separate* operations; setting the On, Off, and Sleep Timers, then selecting which timers you want to operate. For example, you might want your radio to turn on at a certain time and remain on, rather than turning off later. You could have the Sleep Timer turn the radio off in 30 minutes, but disable the On-Timer so you can sleep-in the next morning. The procedure used to set the timers is similar to the operation you just used to for the clocks.

- From any mode, press *and hold* the **TIMER** key for longer than 1/2 second. "TIMER ON" and "SET" will appear blinking at the bottom of the display, as shown (default).

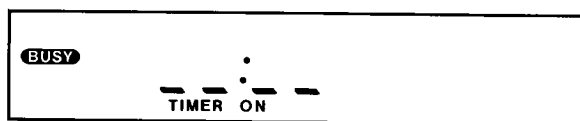

- Press **SET** to activate the timer, then use the main tuning dial or **UP ▲ DOWN ▼** keys to adjust the time you want the radio to turn *on*.
- Next, press **SEL** to select the Off Timer, and using the above procedure, adjust the time you want the radio to turn *off*.
- Press **SEL** again for the Sleep Timer, and set the time delay (up to 2 hours) before the radio will turn it'self off.
- Press **TIMER** *momentarily* to save the settings. The display will return to the previous frequency however, "TIMER ON OFF

"SLEEP" will appear at the bottom of the LCD as shown below.



This indicates that the *all* of the timers are enabled *and* turned on (*there's a difference!*).

- Press the **TIMER** key again momentarily, the previous timer indications at the bottom of the display will disappear.

Toggling the **TIMER** key turns on/off *any* timers you have enabled (in this case, all of them). At this point, you can go back and enable/disable individual timers to your own preference.

- Press *and hold* the **TIMER** for longer than 1/2 second. The display will begin blinking and indicate your previous On-Timer setting.
- Toggle the **SEL** key as before to enable/disable the timer(s) you want (let's disable the Off-Timer and Sleep-Timer in this example).
- To disable the timer, press the **SET** key. The display will appear as before (in the previous default setting), indicating the timer is disabled (the programmed time setting is still saved). Pressing **SET** again will enable the timer. By toggling the **SEL** and **SET** keys in this way, individual timers can be selected and enabled/disabled.
- After disabling the Off-Timer and Sleep-Timer, press **VFO/MEM** *momentarily* to return to normal operation.
- To turn on the Timer feature, simply press **TIMER** *momentarily*, the display will now reflect currently enabled timer functions and the timing cycle will begin.



Timer Cycling and Operation

Timer operation begins and cycles from the moment that **TIMER** is pressed. The radio will power on and off according to the timers, unless they are turned off, or the timing cycle is interrupted by turning the radio off and on again using the **POWER** switch.

For example, if 45 minutes of delay was selected for the Sleep-Timer, the count-down be-

gins as soon as you press the **TIMER** key. After the radio turns off, it can be turned on once again by merely pressing **TIMER** (turning the timer function off). Toggling **TIMER** gain would repeat the process and give you another 45 minutes sleep delay time.

If your radio suddenly turns off for no apparent reason when you turn on the Timer feature, don't be alarmed, it is because your present clock time falls outside of the On/Off timing cycle.

For example, if the On-Timer was set for 9 A.M. and Off-Timer for 5 P.M., and were both enabled, turning on the Timer feature while listening to the radio at 7 P.M. would result in the radio immediately powering itself off until 9 P.M. the next morning! To override this, just press **TIMER**, now *you* are back in control.

Diagnostic Test

To perform the "Las Vegas Display" diagnostic test of the display and it's microprocessor, and to check the ROM version of your receiver, press and hold the **SET** key while turning on the receiver. This procedure will not erase any data. After testing the display segments, "YAESU" will be displayed, followed by a ROM version number. (as shown below). After a few seconds, the display will return to normal operation

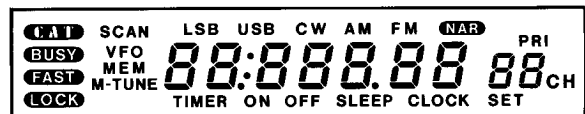

YAESU 101

Installing Internal Accessories

This chapter describes installation of the internal options available for the FRG-100. The YF-110C/CN crystal filters and FM Unit-100 can be installed by removing only the top cover. In addition, beep volume adjustment and DC Fuse access are possible. Installing the TCXO-4 master oscillator or replacement of the Lithium memory Back-up battery requires removing the bottom cover. This chapter describes the cover removal procedures first, followed by the individual procedures for each option. Proper performance with these options depends on proper installation. If you are unsure of the procedures after reading the following, feel free to ask your Yaesu dealer for help.

Top Cover Removal

- Turn the receiver off, and disconnect all cables.
- Place the set on stable work surface with the front facing you, and remove the eight screws affixing the top cover (Figure 1). Do not remove the four screws attaching the loudspeaker, or the screws attaching the carrying handle. Slowly lift the top cover off.
- Place the cover behind the radio, while paying close attention to the loudspeaker wire and connection at **J1019**

FM UNIT-100 Installation

The FM Unit option can be installed to permit narrow bandwidth FM reception across the entire receiving range of the FRG-100.

- With the front of the radio facing you, locate the six-pin connector **P1003**. It is approximately 4 cm to the right of the mounting screw in the center of the circuit board. A solid white line on the surface of the printed circuit board is provided to aid alignment and installation.
- Install the FM unit by vertically aligning the six holes on the unit connector with the six protruding pins of **P1003**, then gently pressing down to mate the FM Unit to the receiver circuit board. You may now replace the cover.

Beep Volume Adjustment

The audio beep volume can be adjusted by potentiometer **VR1005**, located at the bottom edge of the circuit board (Figure 2.)

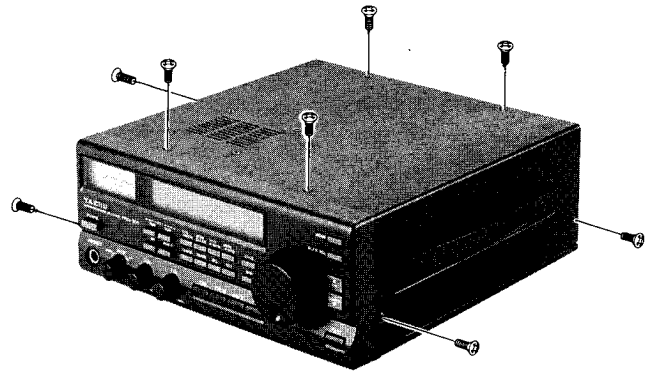

Figure 1: Top Cover Removal

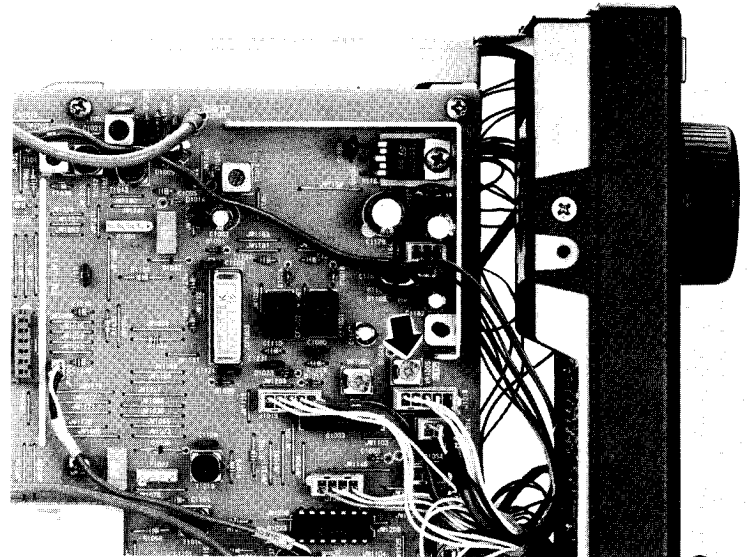

Figure 2: Top View

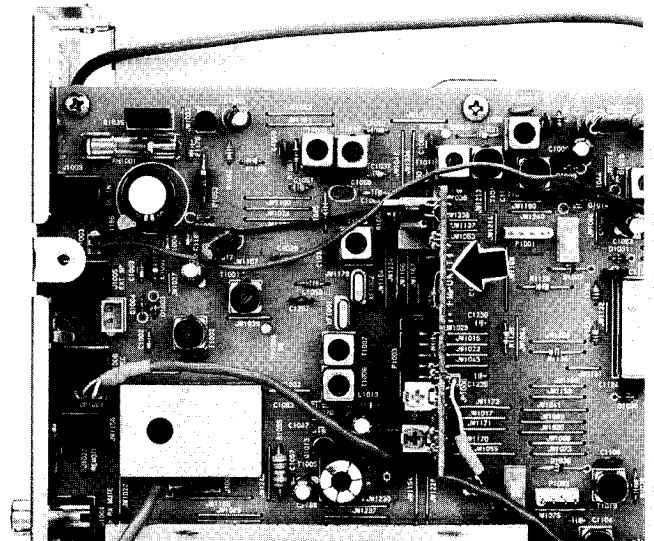

Figure 3: FM Unit Installation

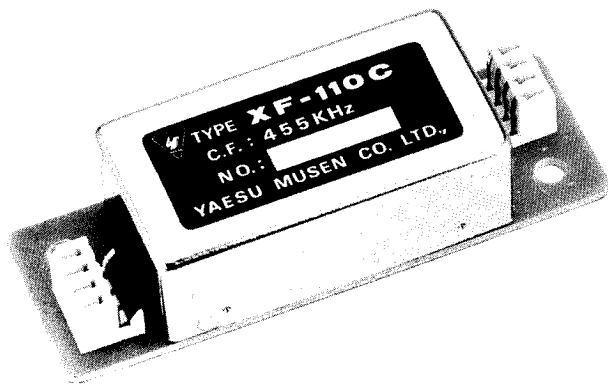

Fig. 4: YF-110C/N Narrow CW Crystal Filters

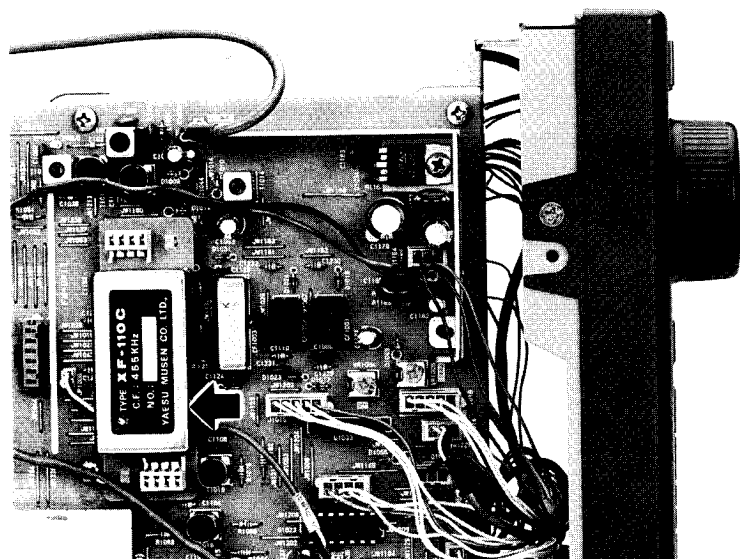

Figure 5: Filter Installation

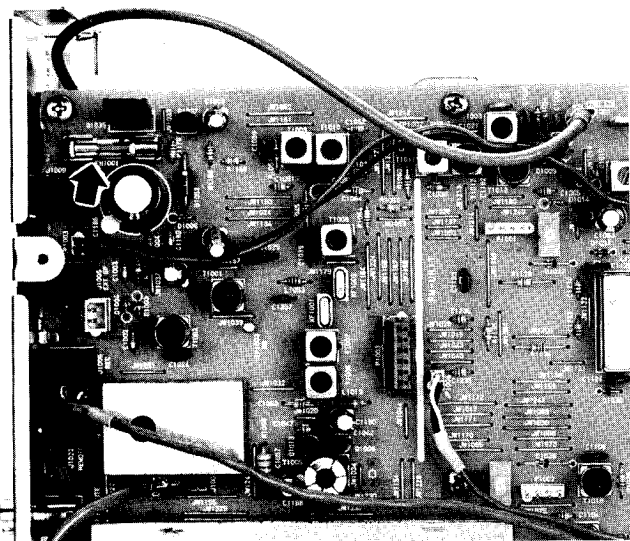

Figure 6: Fuse Replacement

- With the radio on, use a small insulated screwdriver to adjust **VR1005**. Rotating the potentiometer clock-wise to increase the volume, and counter clockwise to decrease it.
- Beep volume can be confirmed by pressing a key, or by using the beep tone frequency setting to enable a continuous tone while setting the volume (see page 19). You may now replace the cover.

Optional CW Crystal Filters

The 500-Hz YF-110C or 250-Hz YF-110CN crystal filters (Figure 4) may be installed for CW narrow reception (they cannot both be installed, as they use the same mounting location).

- Referring to the photo at the left, determine the location of **P1001** & **P1002** and the nylon mounting stand-offs (directly below the FM Unit).
- Straddle the crystal filter unit across **P1001** & **P1002**, while carefully aligning the pins protruding from the board to the connector holes at the ends of the filter unit. Filter orientation is not critical since it will fit when mounted in either direction.
- When the filter unit has been mated to the connector pins, gently press down *by the ends* until the nylon mounting stand-offs push through the holes in the filter unit board and expand to lock it in place (Figure 5). You may now replace the cover.

Fuse Replacement

The internal fuse should not normally require replacement. If it blows, first determine the cause before replacing it. Fuse ratings should never be exceeded, and replacement should be with that of an identical voltage and current rating.

- Ensure the power is disconnected and cables removed,
- Locate fuse **FH1001** at the upper right corner of the circuit board next to the **DC 12 V IN** connector (Figure 6).

Caution!

Fuse replacement using other than a fuse pulling tool is not recommended due to the possibility of fuse breakage, and damage to surrounding components.

- ❑ Using a fuse pulling tool, firmly grasp the fuse and pull it straight up and out of its holder. Note the voltage and current ratings on the ends of the fuse. Install the replacement in the same manner. You may now replace the cover.

Bottom Cover Removal

- ❑ Turn the receiver off, and disconnect all cables.
- ❑ Place the radio on stable work surface with the front facing you, and remove the eight screws affixing the bottom cover (Figure 7). Note the style and size of the screws, two flat head screws are used only at the front of the bottom panel, ensure they are replaced in the same location when re-installing the bottom cover.

Figure 7: Bottom Cover Removal

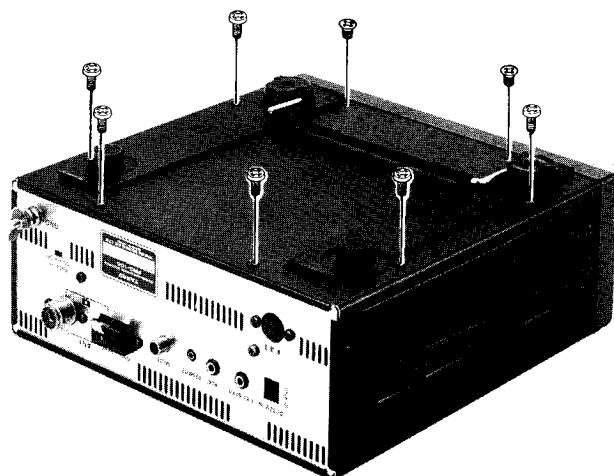

TCXO-4 Installation

The ± 2 -ppm TCXO-4 (Temperature Compensated Crystal Oscillator) can be installed as a replacement for the standard ± 10 -ppm crystal oscillator.

- ❑ Locate the four pin connector **J2014** on the lower printed circuit board. It is located approximately three centimeters above and to the left of the mounting screw in the center of the board.
- ❑ Mate the TCXO unit with the connector **J2104** by carefully aligning its protruding pins with the connector on the TCXO unit board.
- ❑ Press down gently with even pressure on both ends, until the TCXO board is firmly seated, and the top of the nylon stand-off mount pushes up through the hole in the board, locking it in place. You may now replace the cover.

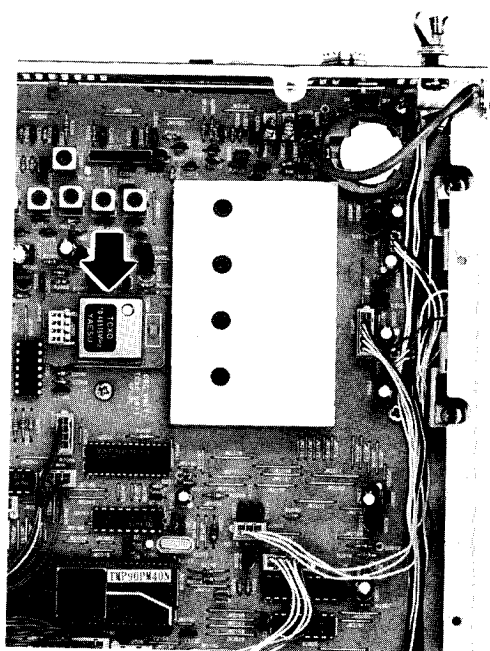

Figure 8: TCXO Installation

The Memory Back-up Switch & Replacing the Lithium Memory Back-up Battery

A replaceable 3-volt Lithium Battery **BT2001** is located on the bottom circuit board of the receiver (Figure 9). This maintains the memorized settings in your radio. Normal battery life is usually greater than five years, however, should replacement be needed, perform the following steps.

- ❑ Ensure the radio is turned off and the power is disconnected. Remove all cables and connectors.

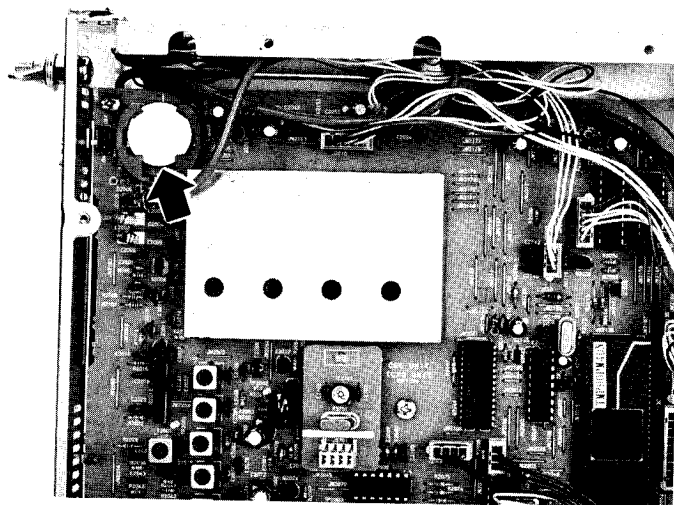

Figure 9: Lithium Battery Location

- ❑ With the receiver front panel facing you, locate the round battery in the rear right corner of the lower circuit board. It is located directly behind the rear panel memory back-up switch.
- ❑ Using your finger, slide the battery to the left (you will feel slight resistance by the the spring), then slightly pry up the right side of the battery, so that it is free to eject upward and outward through the vertical slots at the top and bottom of the plastic battery holder (Figure 10).
- ❑ Carefully note the polarity (positive + side facing up) and battery type information.
- ❑ The replacement battery is installed in the reverse manner.

Caution!

Do not dispose of the old lithium cell in fire, to prevent possible explosion. Also, ensure disposal in a safe place to prevent children from accidentally choking on or ingesting the cell.

Backup Switch

Located on the rear panel of the receiver is the memory **BACKUP ON-OFF** switch. It is normally kept in the ON position to ensure that your memorized information is maintained (by a small amount of power from the Lithium Battery) when the radio is off, or the DC power source is removed.

If you do not plan to operate your radio for extended periods of time, turn this switch OFF to conserve battery life. Move the selector using the tip of a ball point pen or similar object. To prolong lithium battery life, ensure the radio is turned ON while switching the **BACKUP** switch from **OFF** to **ON**. This reduces the current demand placed on the battery by the radio's circuits from an un-powered state.

Note: memorized settings will be lost and the radio will return to the factory default settings, when turning off the backup battery. This has the same effect as performing the power-on sequence as described on page 22.

Cover Screws

There are three types of screws used for top and bottom cover attachment. Refer to figure 12 if there is any uncertainty on screw type and location.

Figure 10: Removing Lithium Battery

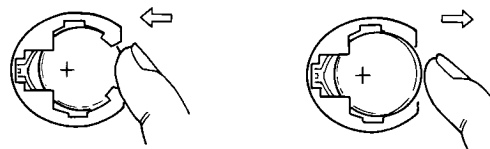

Slide cell inward, then pry up to eject.

Inserting Replacement Battery

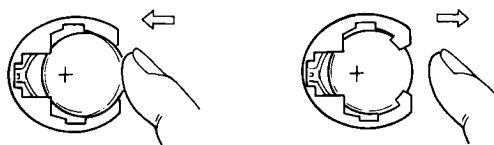

Slide cell downward through slot, then inward and release.

Figure 11: BACKUP SWITCH

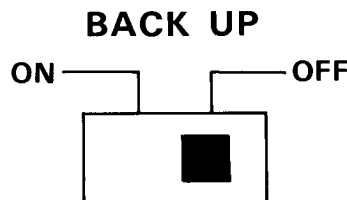

Figure 12: Cover Screws



Binding-Head
Screw M3 x 6B



Flat-Head
Screw M3 x 6B



Oval-Head
Screw M3 x 6B

CAT CONTROL SYSTEM

The CAT (Computer Aided Transceiver) System in the FRG-100 provides control of frequency, mode VFO, memory and other settings by the operator's personal computer. This allows multiple control operations to be fully automated as single mouse click or keystroke operations on the computer keyboard.

Serial data is passed at TTL levels(0 and +5V) via SO (serial output) and SI (serial input) pins 2 and 3 of the CAT jack on the rear panel of the receiver, at 4800 bits/sec. CAT jack pinout is shown on page XX. Each byte sent consists of one start bit, 8 data bits, no parity and two stop bits:

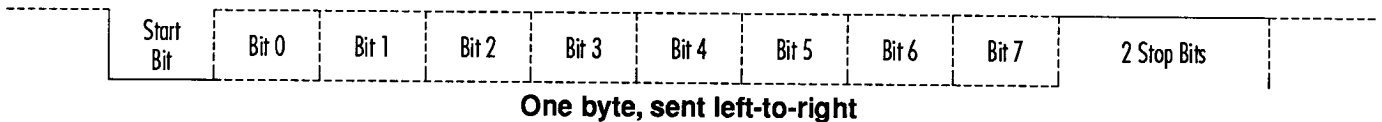

All commands sent to the receiver must consist of *blocks* of five bytes each, with up to 200 ms between each byte. The last byte sent in each block is the *instruction opcode*, while the first four bytes of each block are arguments: either parameters for that instruction, or dummy values (to pad the block out to five bytes):

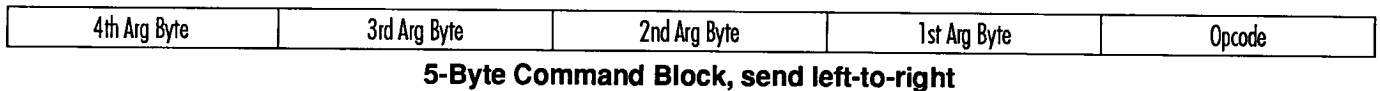

There are nineteen instruction opcodes for the FRG-100, listed in the table on the next page. Notice that several instructions require no specific parameters, but every command block sent to the receiver *must* consist of five bytes.

The CAT control program in the computer must construct the 5-byte block by selecting the appropriate instruction opcode, organizing the parameters, if any, and providing unused (dummy) argument bytes for padding (dummy bytes may have any value). The resulting five bytes are then sent, *opcode last*, to the SI serial input pin of the CAT jack on the receiver.

Example: Tune to 14.25000 MHz;

- First determine the opcode for the desired instruction (see the CAT Commands table, next page). These opcodes should be stored in the program so they can be looked up when the user requests the corresponding command. In this case the instruction is "Set Op Freq", so the opcode is 0Ah. Small "h" following each byte value indicate hexadecimal (base 16) values.
- Build the four argument byte values from the desired frequency by breaking it into 2-digit blocks (BCD "packed decimal" format). Note that a leading zero is always required in the hundred's-of-MHz place (and another in the ten's-of-MHz if below 10 MHz).
- The resulting 5-byte block should look like this (again, in hexadecimal format):

Byte Value	0Ah	01h	42h	50h	00h
Content of this byte	Set Op Freq. opcode	100's & 10's of MHz	1's of MHz & 100's of kHz	10's & 1's of kHz	100's & 10's of Hz

- Send these five bytes to the receiver, in *reverse order* from that shown above — from right-to-left (see the examples on page 38).

Data Returned From FRG-100

The *Status Update*, *Read Flags* and *Read Meter* commands cause the FRG-100 to report various operational and internally stored settings on the SO (serial output) line:

Status Update causes the FRG-100 to return all or portions of its RAM table (up to 283 bytes).

FRG-100 CAT Commands

Legend:

Send all commands in reverse order from that shown! Commands that duplicate a front panel button are named with all caps. Parameter variables are named to reflect their format: eg., "CH" indicates a memory channel number, from 01h to 34h (1 to 52 decimal). "—" indicates a padding byte. Value is unimportant, but it must be present to pad the block out to exactly five bytes. Opcodes are listed in both hex and decimal format for convenience - only one opcode can be actually sent.

Command	Opcode		Parameter Bytes				Parameter Description
	hex	(dec)	1	2	3	4	
Memory Channel Recall	02	(2)	CH	—	—	—	Recalls memory channels 1 ~ 50, Lo & Hi, where CH = 01 ~ 32h (1 ~ 50), 33h (Lo) & 34h (Hi)
VFO ► M	03	(3)	F1	F2	—	—	Copy displayed freq. to memory where F1 is the memory channel (F1=01 ~ 34h) and F2 is the function (F2=00h (SET), 01h (MEM CLEAR), and 02h (recall))
LOCK	04	(4)	P	—	—	—	Tuning knob or panel lock/unlock (P=1/0)
VFO Operation	05	(5)	—	—	—	—	Select VFO Operation
M ► VFO	06	(6)	CH	—	—	—	Copy Memory Channel (CH = 01 ~ 34h) to VFO
UP ▲ (FAST)	07	(7)	—	S	—	—	Step current display up 100 kHz (S=0) or 1 MHz (S=1)
DOWN ▼ (FAST)	08	(8)	—	D	—	—	Same as UP, but steps current display down
Set Operating Freq.	0A	(10)	F1	F2	F3	F4	New operating frequency in F1 ~ F4, in BCD format: see text for example.
MODE	0C	(12)	M	—	—	—	M values: LSB=0, USB=1, CW Wide=3, CW Nar=3, AW Wide=4, AM Nar=5, FM=6 or 7.
PACING	0E	(14)	N	—	—	—	Add N-milliseconds (0=0FFh) delay between bytes of all data returned from radio.
Status Update	10	(16)	U	—	—	—	Instructs the radio to return 1, 18, 19 or 283 bytes of status
POWER	20	(32)	P	—	—	—	Turns the radio OFF/ON P=00h/01h
Clock Set	21	(33)	C1	C2	C3	—	Set current clock time (see chart below)
Timer Set	22	(34)	T1	T2	T3	T4	Set Timer/Sleep Functions (see chart below)
Scan Skip Set	8D	(141)	X	Y	—	—	Select memory channel(s) X= 01 ~ 34h to be skipped during scanning. Y=00h (Skip On) or Y=01h (Skip Off)
Step Oper. Frequency	8E	(142)	D	—	—	—	Step operating frequency up (D=0) or down (D=1) minimum step size (10 Hz or 100 Hz)
Read S-Meter	F7	(247)	—	—	—	—	Instructs radio to return digitized meter indication (4 repeated bytes, and 0F7h)
DIM	F8	(248)	L	—	—	—	LCD backlighting ON/OFF (D=00h/01h)
Read Flags	FA	(250)	—	—	—	—	Instructs radio to return the 24 1-bit Status Flags (5 bytes, see following pages)

Read Flags obtains only the first 3 bytes (the Status Flags) from the RAM table, plus 2 extra "filler" bytes (08h and 41h),

Read Meter returns the meter deflection (0 — 0FFh) repeated in four bytes, followed by one "filler" byte (0F7h).

Each returned byte may be delayed by an interval determined by the *Pacing* command (0 to 255 ms in 1-ms steps). This delay is initially zero until the *Pacing* command is sent. This allows returned data to be read and processed by even very slow computers. However, you should set it as short as your computer will allow, to minimize the inconvenience of the delay. In the worst case, when the radio is to return all 283 bytes of internal data, about 1.4 seconds is required with "0"-length delay selected, but almost 3 *minutes* if the maximum delay is selected!

Status Update Data Organization

The 283 bytes of *Update* data is organized as shown at the top of the page after next. Aside from the *Read Flags* command, different portions of this data can be returned in blocks of 1, 18, 19 or 283 bytes, depending on the parameters of the *Update* command sent by the computer. The details of these commands follow the descriptions of the data.

(A) Flag Bytes

The first 3 bytes are treated as 24 1-bit flag fields: a function is enabled (on) if a bit is set (1), and disabled (off) if reset (0). Most of the functions represented by these flags correspond to the radio display.

First Flag Byte

- Bit 0: LOCK is active (= display)
- Bit 1: Reserved for system
- Bit 2: Reserved for system
- Bit 3: Memory recall in progress
- Bit 4: Memory tuning (M TUNE) activated
- Bit 5: MEM operation (= display)
- Bit 6: Reserved for system
- Bit 7: VFO operation (= display)

Second Flag Byte

- Bit 0: SCAN
- Bit 1: Scan Delay
- Bit 2: Group Scanning
- Bit 3: Priority Scan
- Bit 4: MUTE
- Bit 5: Reserved for system

- Bit 6: Reserved for system
- Bit 7: FAST tuning/scanning rate is activated

Third Flag Byte

- Bit 0: SLEEP Timer ON
- Bit 1: ON Timer ON
- Bit 2: OFF Timer ON
- Bit 3: Clock Display
- Bit 4: Clock #2 Display
- Bit 5: Set Mode Function
- Bit 6: POWER OFF
- Bit 7: 12/24 Hour Time Format

(B) Fourth Byte: Memory Number

The 4th byte of *Update* data contains a binary value between 0 and 34h (52 decimal), indicating the current memory number -1 (or the last-selected memory, if operating on a VFO).

(C) 5-Byte Operating Data Records

The Memory Number is followed by a 5-byte record defining current operating conditions. This record consists of 3-bytes of frequency data followed by 1-byte of mode data and a 1-byte operating.

5-Byte Operating Data Record Format

3-bytes	1-byte	1-byte
Freq. Data	Mode Selection	VFO/MEM Oper. Flag

5-Byte VFO/Memory Data Record Format

Offset	Contents & Format of Byte Field
0-2	Bytes 0 — 2: Base frequency in 10's of Hz. Binary value in range 10000 — 3000000. Byte 1 is MSB.
3	Mode: 0=LSB, 1=USB, 2=CW, 3=AM, 4=FM
4	VFO/Memory Operating Flags (see below)

VFO/Memory Operating Flags

Each bit in this field signifies a state unique to one VFO or half-memory.

- Bit 0: Reserved for system
- Bit 1: Memory Clear
- Bit 2: Memory set to SKIP when scanning
- Bit 3: Reserved for system
- Bit 4: Reserved for system
- Bit 5: Reserved for system
- Bit 6: Current mode is AM NARrow
- Bit 7: Current mode is CW NARrow

(D) VFO Data (5 bytes)

After the 5-byte Data Record for current operation is sent, a 5-byte VFO Data Record is sent. The format of this record is the same as described above.

(E) Memory Data Records (5 bytes)

After the 5-byte record for the VFO, an additional 5-byte Data Record is sent for each memory channel, beginning with memory 01. Each memory data record is constructed as described above for the 5-byte Data Records.

(F) Clock #1 Data Record

This 9-byte data record follows the Memory Data Record for Clock #1 programming. The BCD format follows on the next page.

(G) Clock #2 Data Record

This 9-byte Data record format is similar to Clock #1, however, Timer and Sleep function can be controlled in this record.

9-Byte Clock#1 Data BCD Coding Format	
Offset	Contents & Format of Byte Field
0	Seconds
1	Minutes
2	Hours
3	Day
4	Date
5	Month
6	Year
7	"Leap Year"
8	12/24 Hour Format
9-Byte Clock#2 Data BCD Coding Format	
Offset	Contents & Format of Byte Field
0	Minutes
1	Hours
2	On Timer (Minutes)
3	On Timer (Hours)
4	Off Timer (Minutes)
5	OFF Timer (Hours)
6	SLEEP TIMER
7	Reserved for System

8	Reserved for System
---	---------------------

(H) 19-Byte Operating & Memory Data Record

This record consists of a 1-byte memory flag, followed by 9-bytes of operating status data, plus 9-bytes of padding. Bytes 1, 5, 6, 8, and 11 ~ 19 provide padding, while bytes 2~ 4 contain frequency data. The 7th byte holds the operating mode, and byte 9 contains the VFO/Memory Operating flag.

(I) 18 Byte VFO Data Record

This data record follows the same format as the above 19-Byte record with the exception that the initial 1-byte memory flag is not included.

Status Update Data Selection

The 1st and 4th parameters of the Status Update command allow selection of different portions of the Status Data to be returned, as follows ("U" is the 1st parameter, "CH" is the 4th):

Parameters	Data Returned	Reference (see previous page)
U=0	All 283 bytes	A~G
U=1	Memory Number	B
U=2	19-Byte Operating Data Record	H
U=3	18-Byte VFO Data	I
U=4, CH=1 ~ 34h	19-Byte Mem Data Record for mem CH	H

Note that, in most cases, you will only need to read the 19-byte Operating Data Record (with the first parameter = 2), since all other CAT commands affect only this data (except VFO M and Memory Scan Skip).

Read Flags Data

The Read Flags command retrieves the (first) 3 Flag Bytes of the Status Data. The receiver responds to the Read Flags command by returning the Flag Bytes described on the preceding page, plus two bytes with the constant values of 08h and 41h (in that order), as shown here:

1st Flag Byte	2nd Flag Byte	3rd Flag Byte	Dummy (03h)	Dummy (92h)
---------------	---------------	---------------	-------------	-------------

Read Meter Data

Sending the *Read Meter* command causes the receiver to return a digitized meter deflection indication, between 0 and 0FFh (in practice, the highest value returned will be around 0F0h). Four copies of this value are returned, along with one constant byte (0F7h), as follows:

Meter Byte	Meter Byte	Meter Byte	Meter Byte	0F7h
------------	------------	------------	------------	------

During reception, the signal strength deflection is returned.

Coding Examples

Although Yaesu Musen Company cannot offer to provide complete CAT control programs (owing to the variety of incompatible computers used by our customers), following are a few examples of critical CAT i/o functions, in Basic. Note that all variations of Basic may not support some of the commands, in which case alternate algorithms may need to be developed to duplicate the functions of those shown.

Sending a Command

After "opening" the computer's serial port for 4800-baud, 8 data bits and 2 stop bits with no parity, as i/o device #2, any CAT command may be sent. However, if you determine that your computer may need extra time to process data returned from the receiver, you should send the *Pacing* command first. Here is an example of the *Pacing* command setting a 2-ms delay:

```
PRINT #2,
CHR$(0);CHR$(0);CHR$(0);CHR$(2);CHR$(&HE);
```

Notice that the instruction opcode is sent last, with the first (MSB) parameter sent just before it, and the LSB parameter (or dummies) sent first. The parameters are sent in the reverse order from that in which they appear in the CAT Commands table. Also note that in this and the following examples, we are sending zeros as dummy bytes; although this is not necessary. If you decide to send commands through a 5-byte array, the values of the dummy parameters need not be cleared.

Using the same example as on page 34 the following command could be used to set the frequency of the display to 14.25000 MHz:

```
PRINT #2, CHR$(&H00); CHR$(&H50);
CHR$(&H42); CHR$(&H01); CHR$(&HA);
```

Notice here that the BCD values can be sent just by preceding the decimal digits with "&H" in this example. However, in an actual program you may prefer to convert the decimal frequency variable in the program to an ASCII string, and then to convert the string to characters through a lookup table.

If you send a parameter that is out of range for the intended function, or not among the specified legal values for that function, the FRG-100 should do nothing. Therefore, you may wish to alternate your sending regular commands or command groups with a *Read Flags* or an *Update* command, allowing the receiver to let the computer know if everything sent so far has been accepted and acted upon as expected.

Bear in mind that some commands specify "binary," as opposed to BCD-formatted parameters. You can send binary parameters without going through the character/hex string conversion process. For example, the CH parameter in the Command table is binary. You could have the FRG-100 recall memory 29 (decimal) by the following:

```
PRINT #2, CHR$(0);CHR$(0);CHR$(0);CHR$(29);CHR$(2);
```

Reading Returned Data

The reading process is easily done through a loop, storing incoming data into an array, which can then be processed after all expected bytes have been read into the array. To read the meter:

```
FOR I=1 TO 5
  MDATA(I) = ASC(INPUT$(1,#2))
NEXT I
```

Recall from above that the meter data consists of four identical bytes, followed by a filler byte, so we really only need to see one byte to get all of the information this command offers. Nevertheless, we must read all five bytes (or 1, 18, 19 or 283, in the case of the Update data). After reading all of the data, we can select the bytes of interest to us from the array (MDATA, in the above example).



YAESU MUSEN CO., LTD.

C.P.O. BOX 1500, TOKYO, JAPAN

YAESU U.S.A.

17210 Edwards Rd., Cerritos, California 90701, U.S.A.

YAESU EUROPE B.V.

Snipweg 3. 1118AA Schiphol, The Netherlands

Copyright © 1992
Yaesu Musen Co., Ltd.
All rights reserved.