

HF Transceiver

MARK-V FT-1000MP

Technical Supplement

(Includes AC Power Supply FP-29)

© 2001 VERTEX STANDARD CO., LTD. Printed in Japan.

VERTEX STANDARD CO., LTD.
4-8-8 Nakameguro, Meguro-Ku, Tokyo 153-8644, Japan

VERTEX STANDARD
US Headquarters
17210 Edwards Rd., Cerritos, CA 90703, U.S.A.
International Division
8350 N.W. 52nd Terrace, Suite 201, Miami, FL 33166, U.S.A.

YAESU EUROPE B.V.
P.O. Box 75525, 1118 ZN Schiphol, The Netherlands

YAESU UK LTD.
Unit 12, Sun Valley Business Park, Winnall Close
Winchester, Hampshire, SO23 0LB, U.K.

YAESU GERMANY GmbH
Am Kronberger Hang 2, D-65824 Schwalbach, Germany

VERTEX STANDARD HK LTD.
Unit 5, 20/F., Seaview Centre, 139-141 Hoi Bun Road,
Kwun Tong, Kowloon, Hong Kong

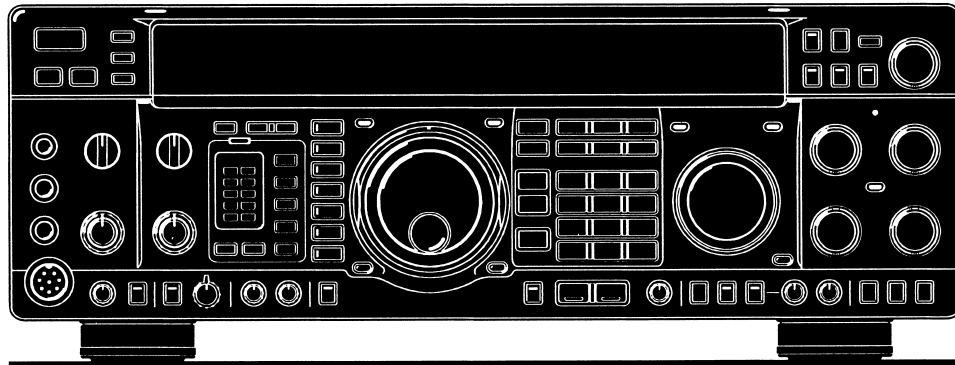

This manual provides technical information necessary for servicing the Yaesu **MARK-V FT-1000MP** HF transceiver. It does not include information on installation and operation, which are described in the **MARK-V FT-1000MP** Operating Manual, provided with each transceiver, or on **MARK-V FT-1000MP** accessories, which are described in manuals provided with each.

The **MARK-V FT-1000MP** is carefully designed to allow the knowledgeable operator to make nearly all adjustments required for various station conditions, modes and operator preferences simply from the controls on the panels, without opening the case of the transceiver. The **MARK-V FT-1000MP** Operating Manual describes these adjustments, plus certain internal settings.

Servicing this equipment requires expertise in handling surface mount chip components. Attempts by non-qualified persons to service this equipment may result in permanent damage not covered by warranty. For the major circuit boards, each side of the board is identified by the type of the majority of components installed on that side. In most cases one side has only chip components, and the other has either a mixture of both chip and lead components (trimmers, coils, electrolytic capacitors, packaged ICs, etc.), or lead components only.

While we believe the technical information in this manual is correct, Yaesu assumes no liability for damage that may occur as a result of typographical or other errors that may be present. Your cooperation in pointing out any inconsistencies in the technical information would be appreciated. Yaesu Musen reserves the right to make changes in this transceiver and the alignment procedures, in the interest of technological improvement, without notification of the owners.

Contents

Specifications	1-1
Exploded View & Miscellaneous Parts	2-1
Alignment	3-1
Circuit Description	4-1
Block & Interconnection Diagram	5-1
PCB Diagrams & Parts Lists	
RF Unit	6A-1
IF Unit	6B-1
AF Unit	6C-1
DDS-CAR Unit	6D-1
I-DET Unit	6E-1
LOCAL Unit	6F-1
DDS-SUB Unit	6G-1
DDS-PLL Unit	6H-1
REF Unit	6I-1
CNTL-1 Unit	6J-1
DISPLAY Unit	6K-1
LPF-1 Unit	6L-1
PA Unit	6M-1
TUNER-MAIN Unit	6N-1
TUNER-CNTL Unit	6O-1
ALC Unit	6P-1
DSP-A Unit	6Q-1
DSP-D Unit	6R-1
RX-2 Unit	6S-1
RX2PLL-DDS Unit	6T-1
RX2CAR-DDS Unit	6U-1
REG Unit	6V-1
SW-A, B, C, D, E Unit	6W-1
VR-A, B, C, D, E, F Unit	6X-1
ENC-A, MIC, HP Unit	6Y-1
KEY Unit	6Z-1
LED Unit	6a-1
INVERTER Unit	6b-1
RL Unit (Lot. 1~8)	6c-1
SSB Filter Unit (Option)	6d-1
AC Power Supply FP-29	
Exploded View & Miscellaneous Parts	7-1
PCB Diagrams & Parts Lists	7-3

CAUTION

Danger of explosion if battery is incorrectly replaced.
Replace only with the same or equivalent type.

General

Rx Frequency Range:	100 kHz - 30 MHz
Tx Frequency Ranges:	160 - 10m (Amateur bands only)
Frequency Stability:	±0.5 ppm (after 1 min. @ 25 °C) ±0.25 ppm (after 1 min. @ 25 °C, w/TCXO-6)
Operating Temperature Range:	-10 °C ~ +50 °C
Emission Modes:	LSB, USB, CW, FSK, AFSK, AM, FM
Frequency Steps:	0.625/1.25/2.5/5/10 Hz for SSB,CW, RTTY & Packet; 100 Hz for AM and FM
Antenna Impedance:	50 Ohms, unbalanced 16.6 - 150 Ohms, unbalanced (Tuner ON, TX only)
Power Consumption:	13.8 VDC 30 VDC Rx (no signal) 2.3 A - Rx (signal) 2.7 A - Tx (200 W) 2.2 A 14.5 A
Supply Voltage:	30 VDC and 13.8 VDC (FP-29)
Dimensions (WHD):	410 x 135 x 347 mm (16 x 5.3 x 13.7 inch)
Weight (approx.):	14 kg. (31 lbs)

Transmitter

Power Output:	Adjustable up to 200 watts (50 watts AM carrier), Class A mode (SSB): 75 watts maximum
Duty Cycle:	100 % @ 100 watts, 50 % @ 200 watts (FM & RTTY, 3-minute Tx)
Modulation Types:	SSB: J3E Balanced, AM: A3E Low-level (early stage), FM: F3E Variable reactance, AFSK: J1D, J2D Audio frequency shift keying
Maximum FM Deviation:	±2.5 kHz
FSK Shift Frequencies:	170, 425, and 850 Hz
Packet Shift Frequencies:	200 and 1000 Hz
Harmonic Radiation:	Better than -60 dB (Typical)
SSB Carrier Suppression:	At least 40 dB below peak output
Undesired Sideband Suppression:	At least 55 dB below peak output
Audio Response (SSB):	Not more than -6 dB from 400 to 2600 Hz
3rd-order IMD:	-31 dB @ 200 watts PEP, or better Class A mode: -50 dB @ 75 watts PEP (Typical)
Microphone Impedance:	500 to 600 Ohms

Receiver

Circuit Type:	Quad-conversion superheterodyne (triple conversion for FM)			
Intermediate Frequencies:	Main Rx; 70.455 MHz/8.215 MHz/455 kHz, Sub Rx; 47.21 MHz/455 kHz			
Sensitivity:	Modes	0.5 - 1.8 MHz	1.8 - 30 MHz	
	SSB/CW (2.0 kHz)	2 µV	0.16 µV	
	AM (6 kHz)	13 µV	2 µV	
	FM	-	0.5 µV	
	(with preamp on, IDBT on, SSB/CW/AM for 10 dB S/N, FM for 12 dB SINAD, 0 dBµ = 1 µV)			
Selectivity (-6/-60 dB):	Band Width	Modes	Minimum -6 dB BW	Maximum -60 dB BW
	2.4 kHz	all except FM	2.2 kHz	4.2 kHz
	2.0 kHz	all except FM	1.8 kHz	3.6 kHz
	500 Hz	CW/RTTY/Packet	500 Hz	1.8 kHz
	250 Hz	CW/RTTY/Packet	250 Hz	700 Hz
		AM (Wide)	4 kHz	14 kHz
		FM	8 kHz	19 kHz
IF Rejection (1.8 ~ 30 MHz):	80 dB or better (Main Rx), 60 dB or better (Sub Rx)			
Image Rejection (1.8 ~ 30 MHz):	80 dB or better (Main), 50 dB or better (Sub)			
Maximum Audio Output:	2.0 W into 4 Ohms with <10% THD			
Audio Output Impedance:	4 to 8 Ohms			

Specifications are subject to change, in the interest of technical improvement, without notice or obligation.

Exploded View & Miscellaneous Parts

REF.	YAESU P/N	Description	QTY.
1	U00520002	PAN HEAD SCREW M5X20NI	1
2	U03306001	SEMS SCREW ASM3X6	8
3	U03308001	SEMS SCREW ASM3X8	8
4	U04206001	SEMS SCREW HSM2.6X6	4
5	U20306001	BINDING HEAD SCREW M3X6	3
6	U20306007	BINDING HEAD SCREW M3X6B	8
7	U20406007	BINDING HEAD SCREW M4X6B	15
8	U22416007	SEMS SCREW HM4X16B	2
9	U23306001	TAPTITE SCREW M3X6	4
10	U24305001	TAPTITE SCREW M3X5	32
11	U24306001	TAPTITE SCREW M3X6	165
12	U24306007	TAPTITE SCREW M3X6B	20
13	U24308001	TAPTITE SCREW M3X8	5
14	U31208007	OVAL HEAD SCREW M2.6X8B	4
15	U31305007	OVAL HEAD SCREW M3X5B	2
16	U31306001	OVAL HEAD SCREW M3X6	6
17	U34306001	TAPTITE SCREW M3X6	5
18	U60200301	HEX NUT N2.6	4
19	U65500102	WING NUT N5NI	1
20	U66500002	FLANGE NUT N5NI	1
21	U70002001	PLANE WASHER FW2.6	4
22	U70005002	PLANE WASHER FW5NI	2
23	U71002001	SPRING LOCK WASHER SW2.6	4
24	U73005002	TOOTHED LOCK WASHER IW5NI	2
25	U75703650	PLAIN WASHER W3X8X0.5FIBER	1
26	Q6000115	TERMINAL B-5 M3	2
27	U9900062	TAPTITE SCREW M1.6X3NI#3	2

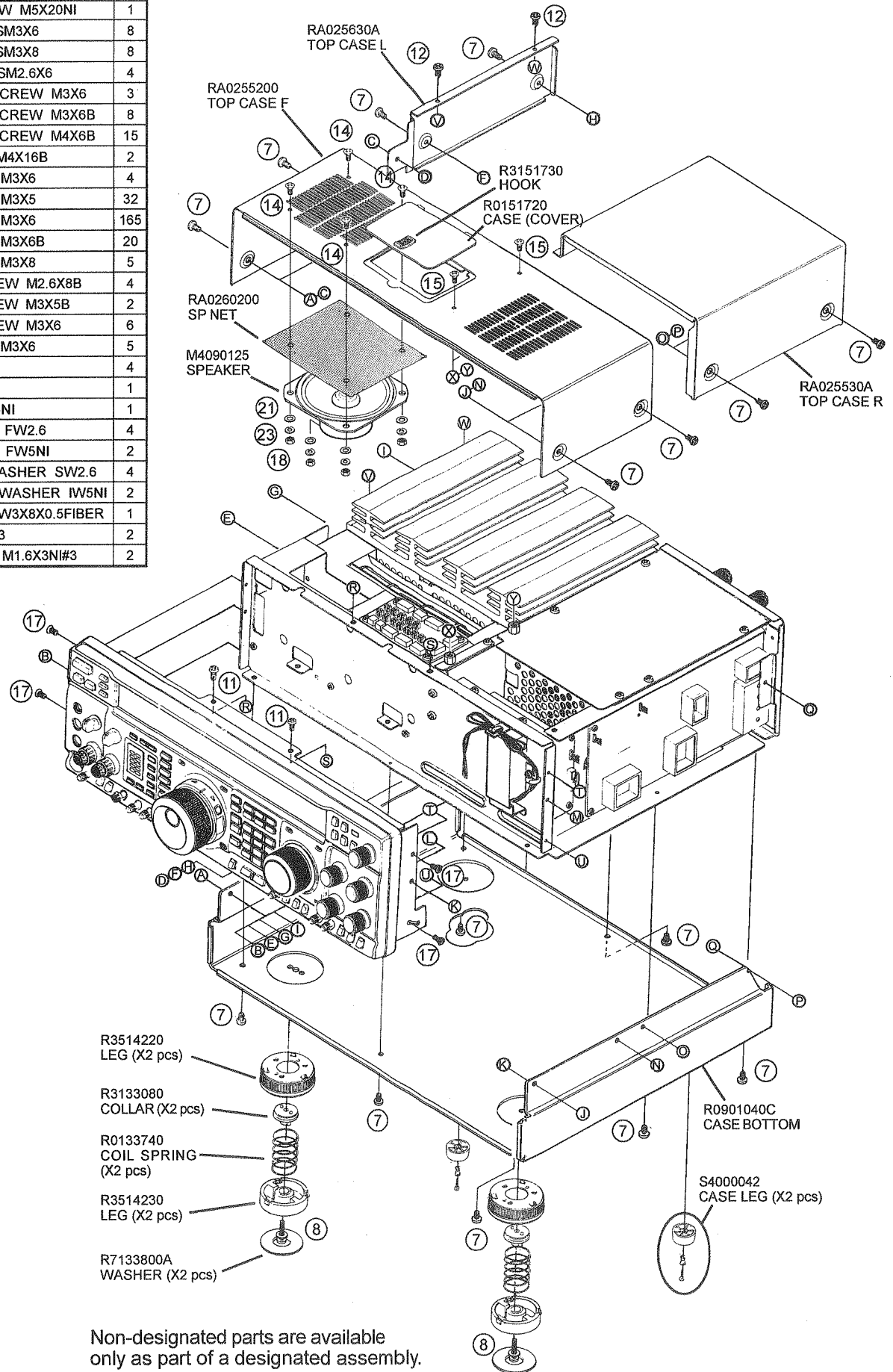

Non-designated parts are available only as part of a designated assembly.

Exploded View & Miscellaneous Parts

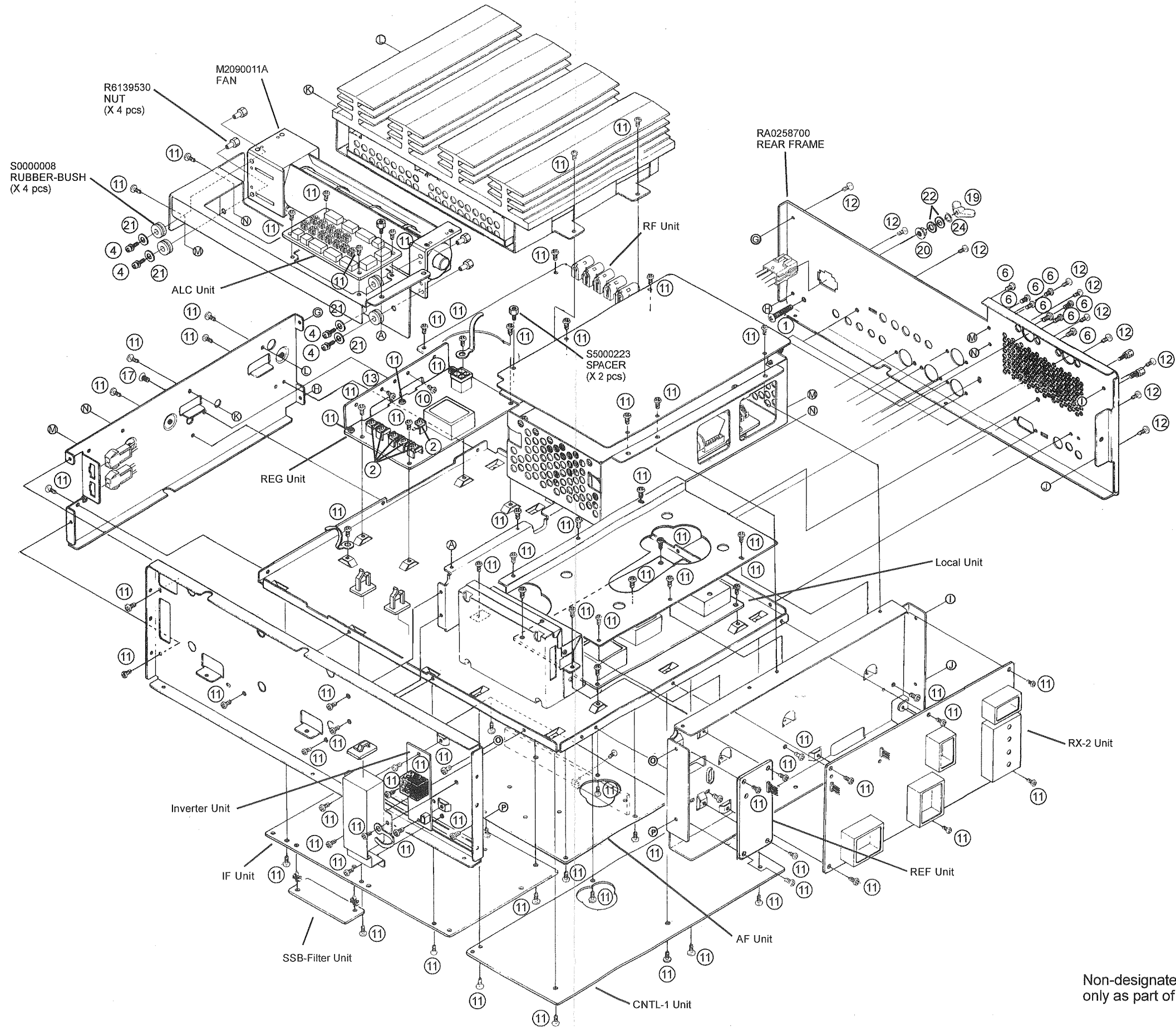

Non-designated parts are available only as part of a designated assembly.

Exploded View & Miscellaneous Parts

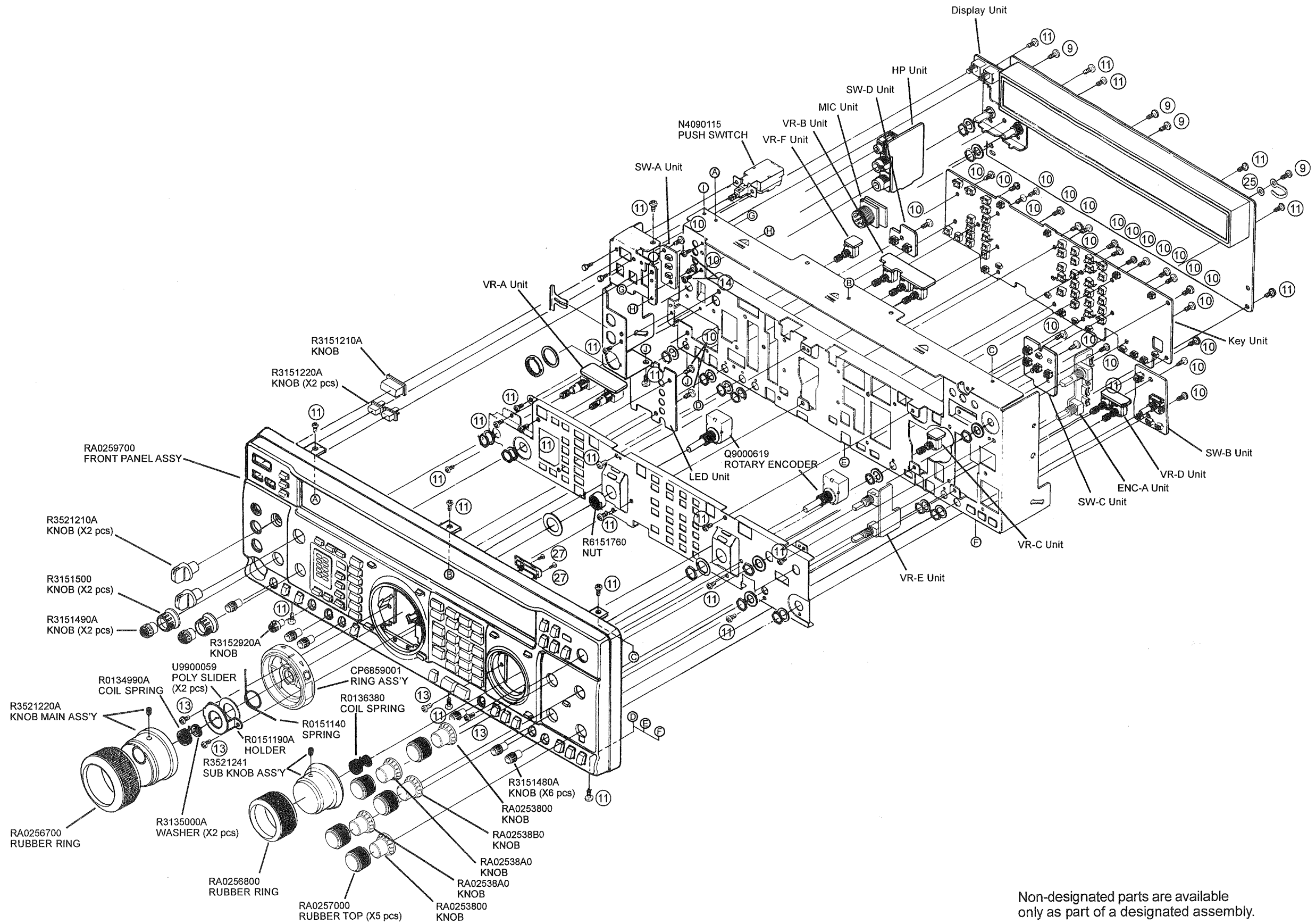

Non-designated parts are available only as part of a designated assembly.

Exploded View & Miscellaneous Parts

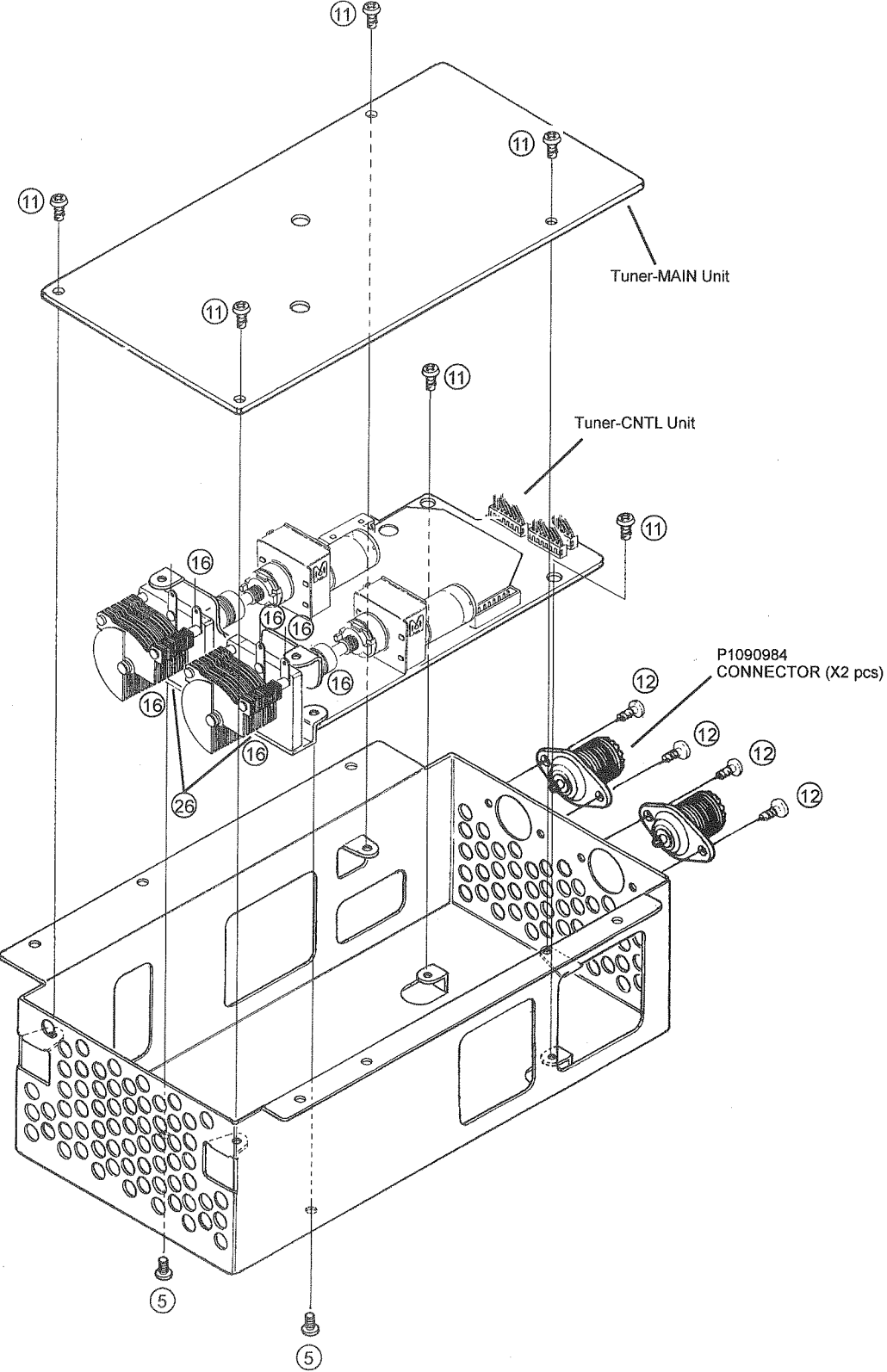
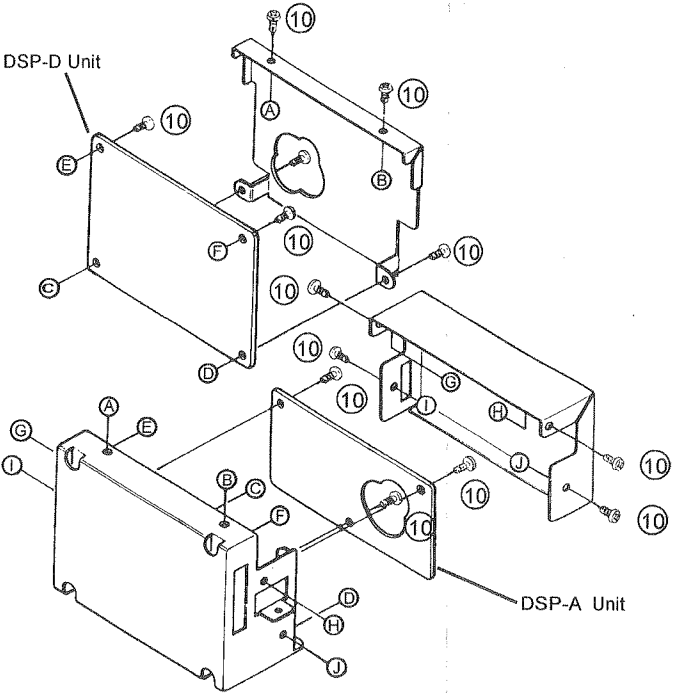
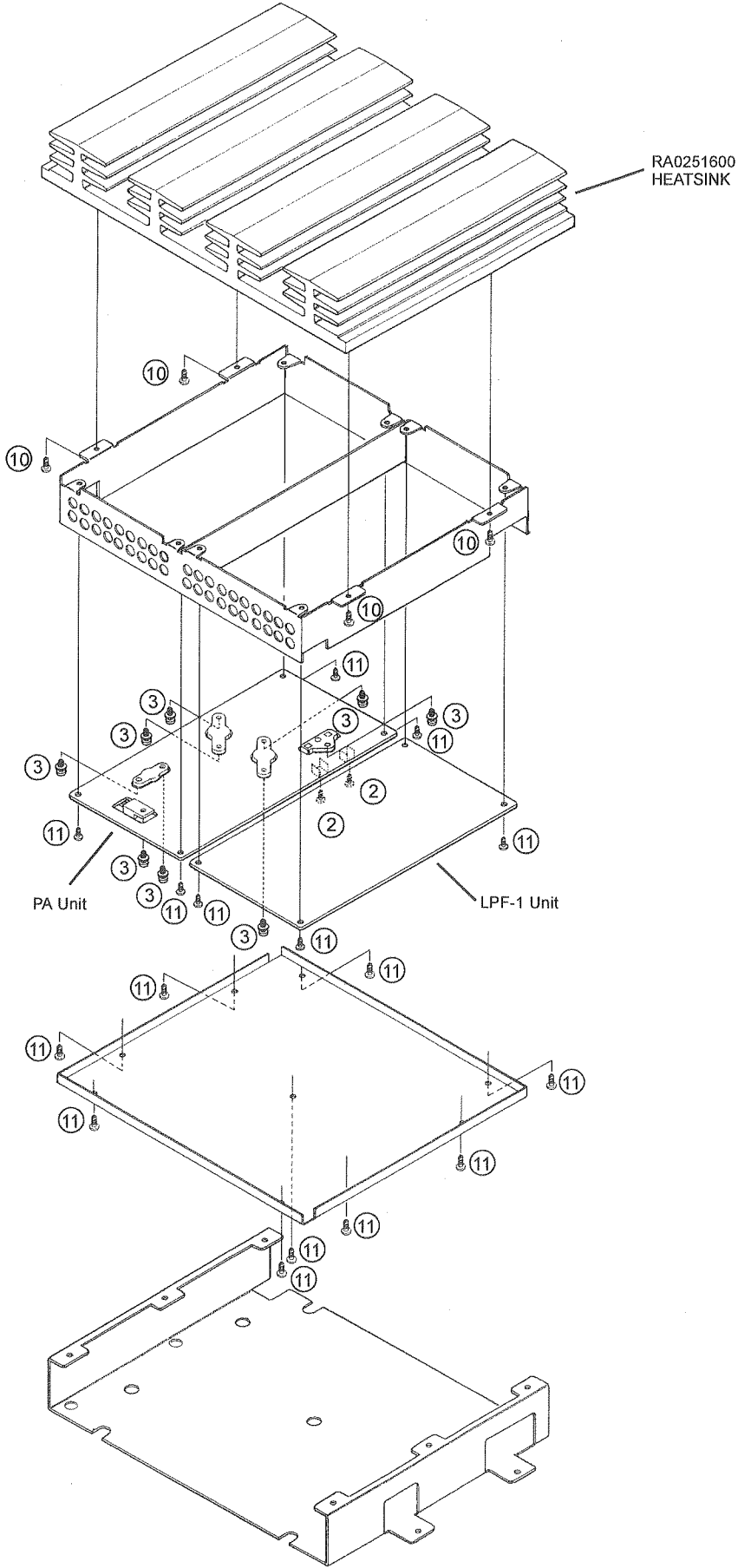

Non-designated parts are available only as part of a designated assembly.

Introduction and Precautions

The following procedures cover adjustments that are not normally required once the transceiver has left the factory. However, if damage occurs and some parts subsequently be replaced, realignment may be required. If a sudden problem occurs during normal operation, it is likely due to component failure; realignment should not be done until after the faulty component has been replaced.

We recommend that servicing be performed by authorized Yaesu service technicians, experienced with the circuitry and fully equipped for repair and alignment. If a fault is suspected, contact the selling dealer for instructions regarding repair. Authorized Yaesu service technicians have the latest configuration information, and realign all circuits and make complete performance checks to ensure compliance with factory specifications after repairs.

Those who do undertake any of the following alignments are cautioned to proceed at their own risk. Problems caused by unauthorized attempts at realignment are not covered by the warranty policy. Also, Yaesu must reserve the right to change circuits and alignment procedures in the interest of improved performance, without notifying owners.

Under no circumstances should any alignment be attempted unless the normal function and operation of the transceiver are clearly understood, the cause of the malfunction has been clearly pinpointed and any faulty components replaced, and the need for realignment determined to be absolutely necessary.

The following test equipment (and thorough familiarity with its correct use) is necessary for complete realignment. Most steps do not require all of the equipment listed, but the interactions of some adjustments may require that more complex adjustments be performed in a sequence. Do not attempt to perform only a single step unless it is clearly isolated electrically from all other steps. Rather, have all test equipment ready before beginning, and follow all of the steps in a section in the order they are presented.

Required Test Equipment

- Digital DC Voltmeter (high-Z, 1 M Ω /V)
- RF Millivoltmeter
- AC Voltmeter
- RF Standard Signal Generator w/calibrated output and dB scale, 0 dB μ = 0.5 μ V
- Signal Generator with calibrated output
- Spectrum Analyzer (60 MHz) or receiver (30 MHz)
- Frequency Counter
- 50 Ω Dummy Load (200 watts)
- 16.6 Ω Dummy load (200 watts)
- In-Line Wattmeter (200 watts, 50 Ω)
- Linear Detector
- RF Coupler

Alignment Preparation & Precautions

A 50 Ω dummy load and in-line wattmeter must be connected to the antenna jack in all procedures that call for transmission, except where specified otherwise. Correct alignment is not possible with an antenna. Except where specified otherwise, the transceiver should be tuned to 14.2000 MHz, USB mode, and these controls set as indicated:

- MOX, VOX, AGC, PROC, IPO, ATT:** OFF
- MIC & RF PWR:** fully CCW (minimum)
- AF GAIN (Volume):** As required
- SQL:** fully CCW (minimum)
- NOTCH & SHIFT:** to 12-o'clock

Read each step to determine if the same test equipment will be required. If not, remove the test equipment (except dummy load and wattmeter, if connected) before proceeding. Correct alignment requires that the ambient temperature be the same as that of the transceiver and test equipment, and that this temperature be held constant between 20 ~ 30 $^{\circ}$ C (68 ~ 86 $^{\circ}$ F). If the transceiver is brought into the shop from hot or cold air it should be allowed time for thermal equalization with the environment before alignment. Alignments must only be made with oscillator shields and circuit boards firmly affixed in place. Also, the test equipment must be thoroughly warmed up before beginning.

Note: Signal levels in dB referred to in alignment are based on 0 dB μ = 0.5 μ V.

Table Note: DC voltages should be within \pm 10 % of those listed in the voltage tables.

TCXO Unit

Carrier Frequency

Refer to the drawing below for the REF Unit (**TCXO-4**) component locations and alignment points.

- Connect the frequency counter to **TP4001**. Confirm the frequency counter reading is 10.485760 MHz \pm 5 Hz. If not, adjust the trimmer capacitor on the **TCXO-4** reference oscillator board to set the frequency to the above value.

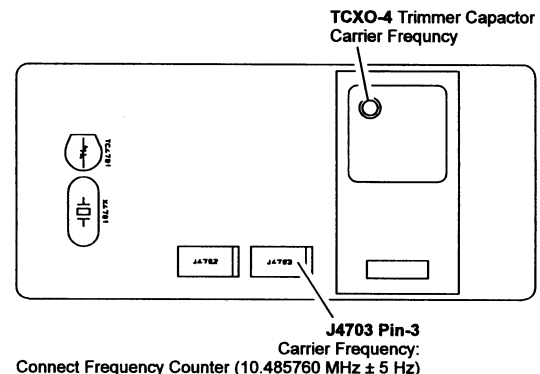

TCXO Unit Test & Alignment Points

Alignment

RX2 Unit

Local Section 2nd OSC

Refer to the drawing at the page bottom for the RX2 Unit component locations and alignment points.

- Connect the RF millivoltmeter to **TP8004**, then adjust **T8018**, **T8016**, and **T8017** in succession several times for peak RF millivoltmeter indication.

2nd Local Frequency

- Connect the frequency counter to **TP8004**, then adjust **T8018** for 46.755 MHz (± 600 Hz) on the frequency counter.

2nd Local Amplifier

- Connect the RF millivoltmeter to **TP8004**, then adjust **T8017** and **T8016** in succession several times for peak RF millivoltmeter indication (at least 500 mVrms).

PLL BPF

- Connect the RF millivoltmeter to **TP8003**, then adjust **T8012**, **T8013**, and **T8014** in succession several times for peak RF millivoltmeter indication (at least 60 mVrms).

PLL Loop VCO

- Connect the DC voltmeter to **TP8005**. Tune the transceiver display to the frequencies shown in the chart below, and adjust the components listed for the corresponding voltage, or else confirm required voltages.

PLL Loop VCO Alignment		
Tune to:	Adjust/Confirm	for
7.499 MHz	Adjust L8007	7.0 ± 0.1 V
0.100 MHz	Confirm	1.3 ~ 2.5 V
14.499 MHz	Adjust L8010	7.5 ± 0.1 V
7.500 MHz	Confirm	1.3 ~ 2.5 V
21.999 MHz	Adjust L8020	7.5 ± 0.1 V
14.500 MHz	Confirm	1.3 ~ 2.5 V
30.000 MHz	Adjust L8024	7.0 ± 0.1 V
22.000 MHz	Confirm	1.3 ~ 2.5 V

RX Section Interstage Transformers

- Connect the RF signal generator to the antenna jack.
- Preset **T8003** to within 3 turns of the top of the coil case, then select either SSB mode.
- Inject an RF signal (no modulation), and adjust **T8002**, **T8004** ~ **T8007**, **T8009** ~ **T8011**, **T8015**, **T8019**, and **T8020** in succession several times for peak S-meter indication (adjust the injection level as necessary to keep the meter around the low side of the S-meter scale).

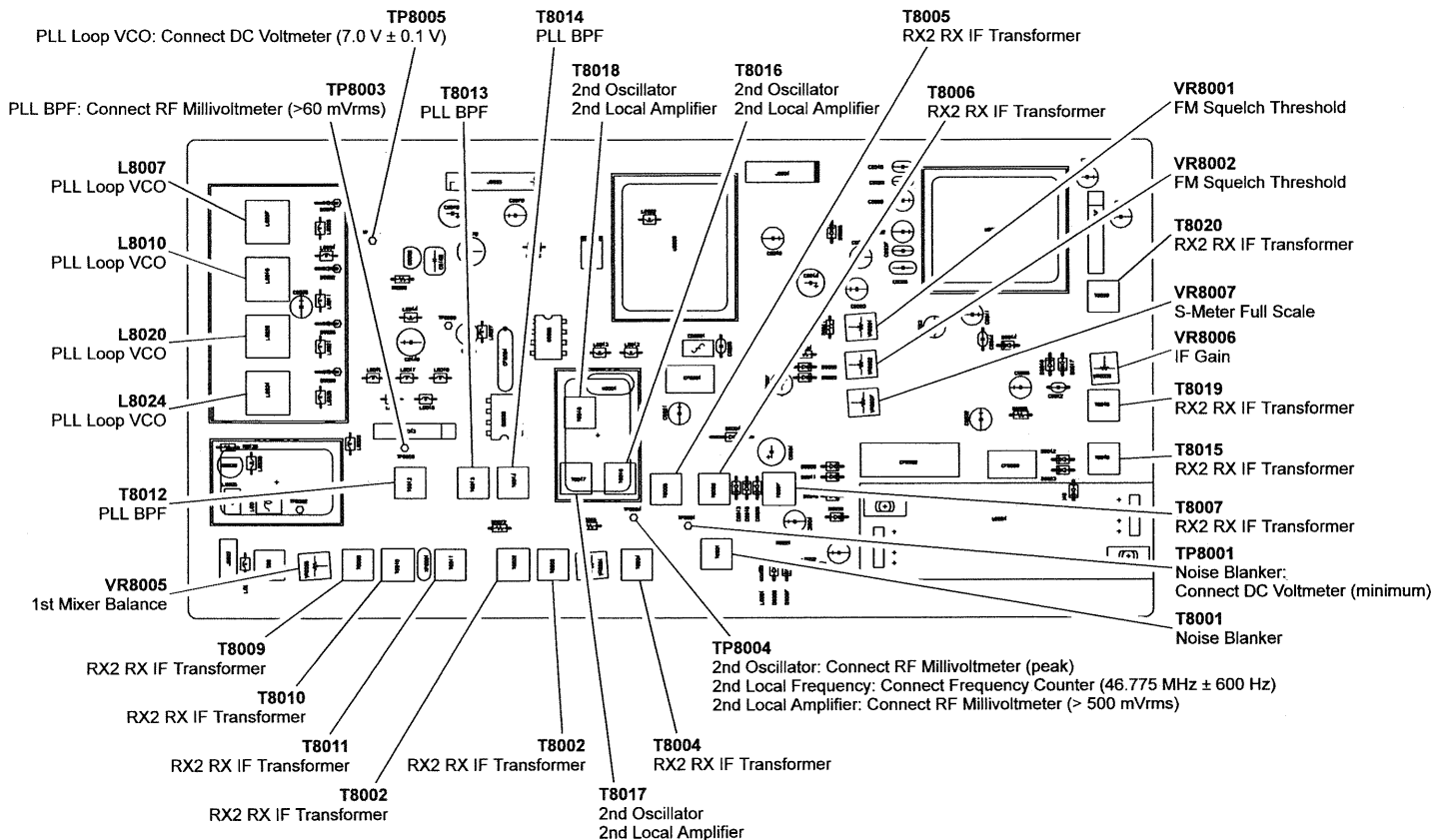

RX2 Unit Test & Alignment Points

IF Gain

- Inject a +11 dB μ signal to the antenna jack, and tune the main dial for peak indication on the S-meter.
- Now adjust **VR8006** for 1-dot S-meter deflection.

S-Meter Full Scale

- Inject a +100 dB μ signal to the antenna jack, and tune the main dial for peak indication on the S-meter.
- Adjust **VR8007** for S9 +60 dB on the S-meter.

1st Mixer Balance

- Set **VR8005** to the 12-o'clock position.

FM Squelch Threshold

- In FM mode, with no signal at the antenna jack, set the SQL control to the 11-o'clock position.
- Now adjust **VR8001** so that the squelch just closes.

SSB Squelch Threshold

- In the SSB mode, with no signal at the antenna jack, set **VR8002** to the fully clockwise position.
- Confirm that the **SQL** control is in the 9- to 12-o'clock position when the squelch is just closed.

Noise Blanker

- Connect the DC voltmeter to **TP8001**, press the **NB** button, then inject a +40 dB μ signal to the antenna jack.
- Adjust **T8001** for minimum indication in the DC voltmeter. Reduce the injection level to +23 dB μ and confirm that the voltage is now less than 3.4 V.

Local Unit

Refer to the drawing at the page bottom for LOCAL Unit component locations and alignment points.

2nd Local Oscillator

- Connect the RF millivoltmeter to **TP4002**, and adjust **T4001** for maximum indication on the RF millivoltmeter (at least 400 mV_{rms}).
- Replace the RF millivoltmeter with a frequency counter at **TP4002**, and adjust **T4001** for 62.240 MHz (\pm 600 Hz).

2nd Local Oscillator Amplifier

- Remove the coaxial plug from **J4002**, and connect a 50 Ω resistor in parallel with the RF millivoltmeter across the socket.
- Adjust **T4006** and **T4007** in succession several times for peak RF millivoltmeter indication (at least 170 mV_{rms}).
- Remove the meter and resistor, and replace the plug into **J4002**.

WIDTH DDS Amplifier

- Connect the RF millivoltmeter to **TP4004**, and adjust **T4010** for maximum indication on the RF millivoltmeter (at least 70 mV_{rms}).

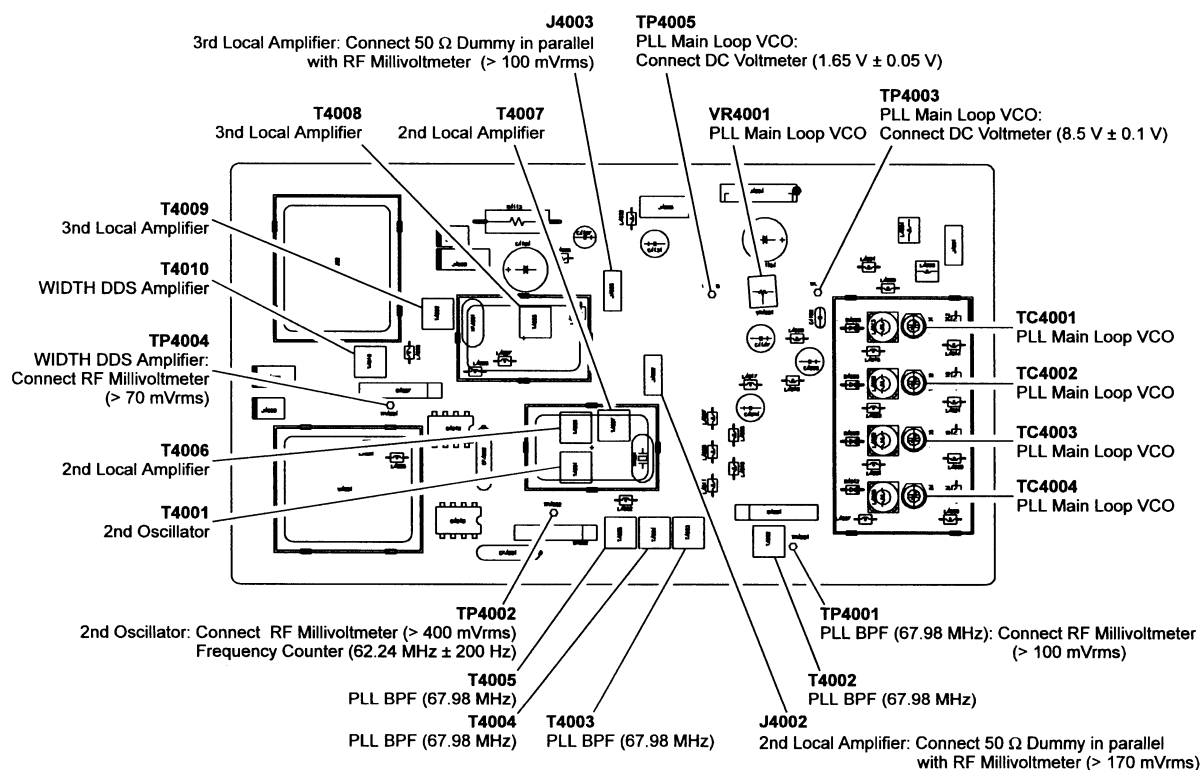

Local Unit Test & Alignment Points

Alignment

3rd Local Amp

- ❑ Remove the coaxial plug from **J4003** and connect a 50 Ω resistor in parallel with the RF millivoltmeter across the socket.
- ❑ Adjust **T4008** and **T4009** in succession several times for peak RF millivoltmeter indication (at least 100 mV_{rms}).
- ❑ Replace the RF millivoltmeter with a frequency counter at **J4003**, and confirm that the frequency is 8.670 MHz (± 30 Hz).
- ❑ Remove the frequency counter and resistor, and replace the plug in **J4003**.

PLL BPF (67.98 MHz)

- ❑ Connect the RF millivoltmeter to **TP4001**, and adjust **T4002** ~ **T4005** in succession several times for peak RF millivoltmeter indication (at least 100 mV).

PLL Main Loop VCO

- ❑ Preset **VR4001** to the 12-o'clock position, and connect the DC voltmeter to **TP4003**.
- ❑ Referring to the table below, tune the transceiver to each frequency, then confirm or adjust the listed component for the required voltage.
- ❑ Tune the transceiver display to 14.200 MHz. Connect the DC voltmeter to **TP4005**, and adjust **VR4001** for 1.65V (± 0.05 V) on the DC voltmeter.

PLL Main Loop VCO Alignment		
Tune to:	Adjust/Confirm	for
7.499 MHz	Adjust TC4001	8.5 \pm 0.1 V
4.000 MHz	Confirm	1.3 ~ 3.5 V
3.999 MHz	Confirm	6.5 ~ 8.5 V
0.100 MHz	Confirm	1.5 ~ 2.5 V
14.499 MHz	Adjust TC4002	8.5 \pm 0.1 V
7.500 MHz	Confirm	1.3 ~ 2.3 V
21.999 MHz	Adjust TC4003	8.5 \pm 0.1 V
14.500 MHz	Confirm	1.3 ~ 2.3 V
30.000 MHz	Adjust TC4004	8.5 \pm 0.1 V
22.000 MHz	Confirm	1.3 ~ 2.3 V

PA Unit

Refer to the drawing below for PA Unit component locations and alignment points.

Driver Idling Current

- ❑ Temporarily disconnect the jumper plug **JP6301** from **J6302**, and connect an ammeter in place of the jumper.
- ❑ Key the transmitter in either **USB** or **LSB** with no microphone input, and adjust **VR6301** for 1.3 A (± 0.1 A). Reinstall the jumper.

Final Idling Current

- ❑ Temporarily remove the solder jumper between **TP6303** and **TP6304**, and connect an ammeter between **TP6303** (-) and **TP6304** (+). Move switch **S6301** to the "VR6303 side."
- ❑ Press the **CLASS-A** switch. Key the transmitter in either **USB** or **LSB** with no microphone input, and adjust **VR6302** for 5.0 A (± 0.2 A).
- ❑ Move **S6301** from the "VR6303 side" to the "VR6305 side." Key the transmitter in either **USB** or **LSB** with no microphone input, and adjust **VR6304** for 5.0 A (± 0.2 A).
- ❑ Depress the **CLASS-A** switch, and move **S6301** from the "VR6305 side" to the "VR6303 side." Key the transmitter in either **USB** or **LSB** with no microphone input, and adjust **VR6303** for 1.0 A (± 0.1 A).
- ❑ Move **S6301** from the "VR6305 side" to the "VR6303 side." Key the transmitter in either **USB** or **LSB** with no microphone input, and adjust **VR6305** for 1.0 A (± 0.1 A).
- ❑ Return **S6301** to its center position, then re-install solder the jumper between **TP6303** and **TP6304**.

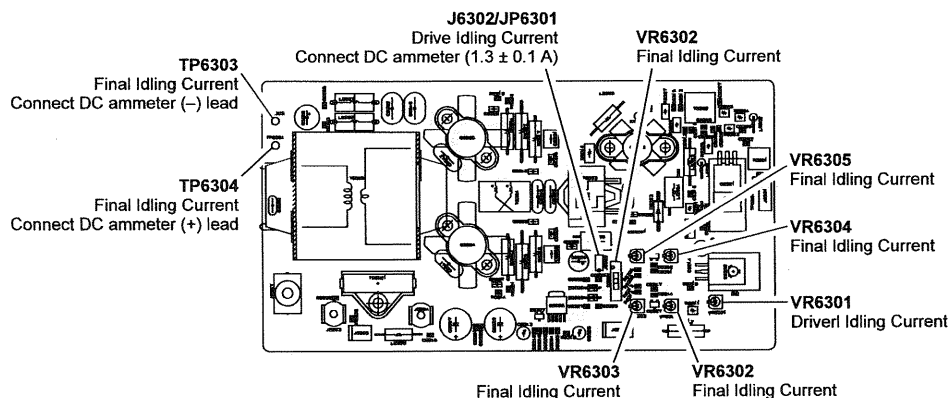

PA Unit Test & Alignment Points

LPF Unit

Refer to the drawing below for LPF Unit component locations and alignment points.

CM Coupler Balance

- ❑ Connect the DC voltmeter to pin 3 of **J6004**, connect a 50 Ω dummy load to the antenna jack, and select the **CW** mode.
- ❑ Key the transmitter, and adjust **TC6001** for minimum indication on the DC voltmeter.

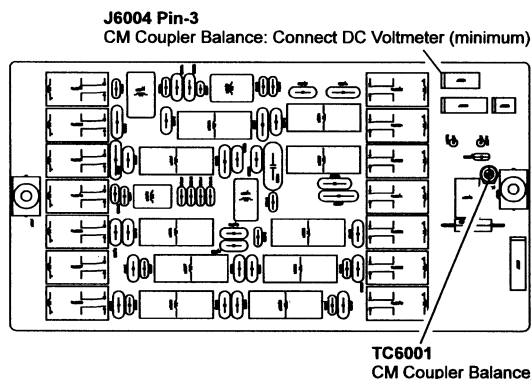

LPF Unit Test & Alignment Points

Tuner Unit

Refer to the drawing at the page bottom for TUNER Unit component locations and alignment points.

Tuning Capacitor/Motor

(Mechanical check, setting & adjustment)

- ❑ Loosen all set screws in the shaft coupler, and turn the coupler by hand to confirm it moves freely (the motor and capacitor should not move).
- ❑ If the coupler binds, check the motor mounting position (it is soldered in place) and the capacitor mounting screw.
- ❑ Turn the power switch off, and jumper **TP6501** to chassis ground. Turn the power switch on. The motor should rotate, and then stop.
- ❑ Set the capacitor to its maximum capacitance position (plates fully meshed) by hand, and tighten all shaft coupler set screw, using care not to disturb the capacitor or motor positions.
- ❑ Turn the power off, and jumper **TP6502** to chassis ground (along with **TP6501**). Turn the power back on. The motor should move 180°, and the capacitor should be then at minimum capacitance (fully unmeshed). Remove the grounding jumpers from **TP6501** and **TP6502**.

Tuner Impedance & Phase Detection

- ❑ Connect the 50 Ω dummy load and wattmeter to **J6501** (the output of the Tuner-Control Unit), and select the CW mode.
- ❑ Connect the DC voltmeter between pin-1 (IZIi) and pin-2 (IZIV) of **J6508** (either polarity).
- ❑ Press the **TUNER** and **MOX** buttons, adjust the **RF PWR** control for 50 watts output, and then adjust **TC6501**, if necessary, for meter indication within ± 0.08 V of 0 V.
- ❑ While still transmitting, move the DC voltmeter to pin-3 (fC) and pin-4 (fL) of **J6508** (either polarity), and adjust **VR6501**, if necessary, for meter indication within ± 0.02 V of 0 V.

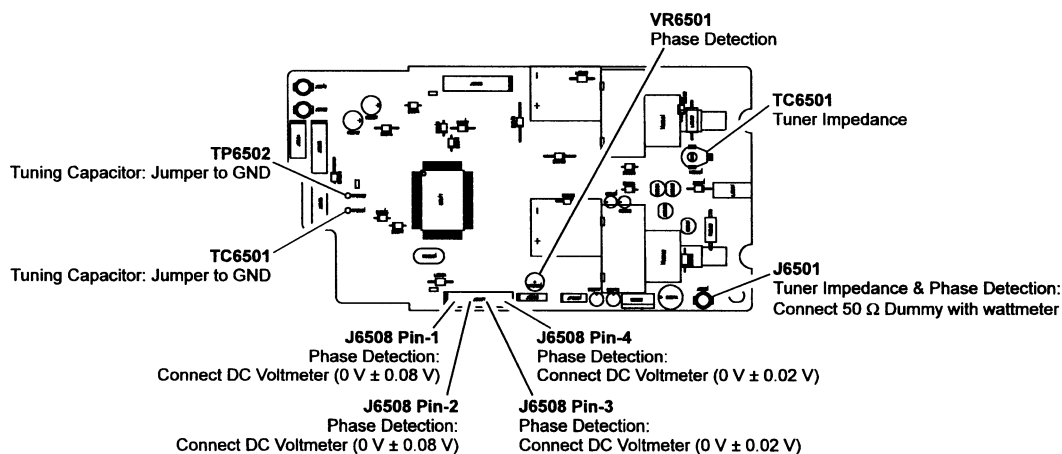

Tuner Unit Test & Alignment Points

Alignment

IF Unit

Refer to the drawing at the page bottom for IF Unit component locations and alignment points.

2nd & 3rd Local Amplifiers

- ❑ Connect the RF millivoltmeter to **TP2003**, and adjust **T2010** for maximum indication on the RF millivoltmeter (at least 450 mV_{rms}).
- ❑ Next, connect the RF millivoltmeter to **TP2005**, and confirm at least 100 mV_{rms}.

Rx IF Interstage Transformer (I) (Coarse Alignment)

- ❑ Connect the RF signal generator to **J2003**, and inject a +100 dBu signal at 70.455 MHz. Connect the AC voltmeter *across* and an 4 Ω dummy load *to* the **EXT SP** jack on the rear panel.
- ❑ Preset **VR2004** to the 12-o'clock position, and adjust **T2003** ~ **T2009**, **T2011**, and **T2012** in succession several times for peak indication on the AC voltmeter.

RF Interstage Transformers (Coarse Alignment)

- ❑ Preset **VR1001** and **VR1002** to their 12-o'clock positions, and select either **USB** or **LSB** mode. Adjust **T1005** ~ **T1009** on the RF Unit in succession several times for peak noise from the speaker.

S-Meter (Coarse Alignment)

- ❑ Preset **VR2003** fully counter-clockwise, and adjust **VR2003** so that all S-meter segments are just turned off. Preset the **RF GAIN** control fully counter-clockwise, and adjust **VR2002** so that all S-meter segments are just turned on.

1st Mixer Balance

- ❑ Tune the transceiver to 1.800 MHz, then adjust **VR1001** and **VR1002** for minimum noise from the speaker.

IF Interstage Transformers (II)

- ❑ Connect the RF signal generator to the antenna jack, and inject a +80 dBμ signal at 14.2000 MHz.
- ❑ Select the **USB** mode, and tune the transceiver to 14.20220 MHz (so that a 2200 Hz tone is heard); adjust **T1005** ~ **T1009**, **T2003** ~ **T2009**, **T2011**, and **T2012** in succession several times for peak S-meter indication (adjust the injection level as necessary to keep the meter around mid scale).

RF Amplifiers

- ❑ Confirm that menu function 8-4 is set to "Tuned," then connect the RF signal generator to the antenna jack, and inject a +20 dBμ signal.
- ❑ Referring to the table below, tune the transceiver and RF signal generator to the listed frequencies, and adjust the corresponding components for the levels shown.

RF Amp Alignment		
Tune SG & Radio to	Adjust	for
1.910 MHz	T1001 20	Max S-meter
3.725 MHz	T1002 21	Max S-meter
7.110 MHz	T1004 22	Max S-meter
28.200 MHz	T1012 16	Max S-meter

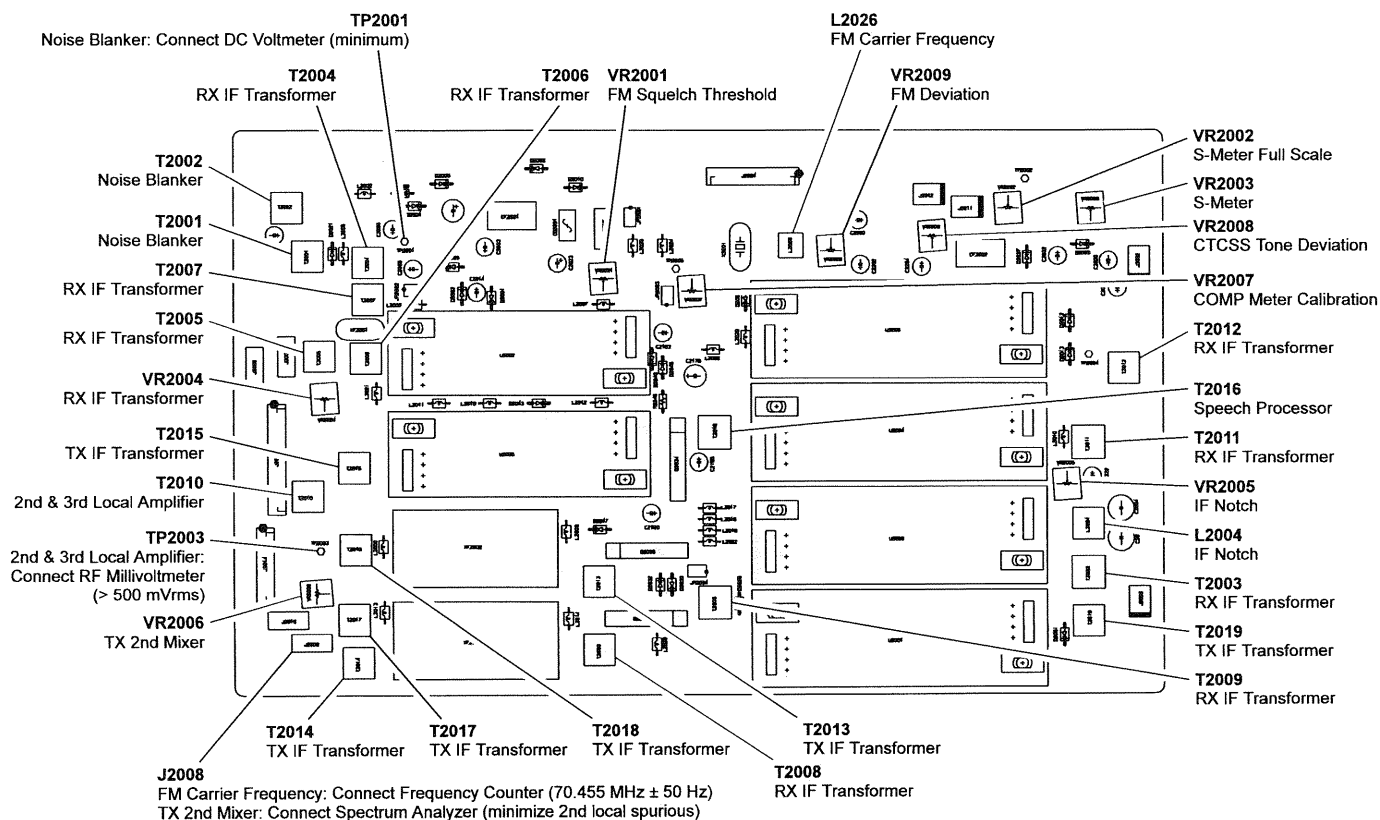

IF Unit Test & Alignment Points

VRF

- Turn the transceiver off, then press and hold the [SUB] and [ENT] keys of the keypad, and turn the transceiver on again.
- Connect the RF signal generator to the antenna jack, and inject a +20 dBμ signal.
- Press the **VRF** button on the shuttle Jog, then adjust the **VRF/MEM CH** knob to illuminate the “center” segment of the Expanded Tuning Scale (above the main VFO-A frequency display).
- Referring to the table below, tune the transceiver and RF signal generator to the listed frequencies, and adjust the corresponding components for the levels shown.

VRF Alignment		
Tune SG & Radio to	Adjust	for
1.910 MHz	T1026 & T1027	Max S-meter
3.775 MHz	T1028 & T1029	Max S-meter
7.260 MHz	T1030 & T1031	Max S-meter
10.100 MHz	T1032 & T1033	Max S-meter
14.100 MHz	T1034 & T1035	Max S-meter

IF Gain

- Turn the transceiver off, then press and hold in the **FAST** and **LOCK** buttons (near the main VFO knob), and turn the transceiver on again.
- Connect the RF signal generator to the antenna jack, and inject a +11 dBμ signal. Select *menu function 9-1*, and adjust the main VFO knob for a 1-segment S-meter deflection.

S-meter Full Scale

- Connect the RF signal generator to the antenna jack, and inject a +100 dBμ signal.
- Tune for peak indication on the S-meter. Now adjust **VR2002** for S9+60 dB on the S-meter.

Noise Blanker

- Set *menu function 2-8* to “A15,” then press the **NB** switch on, and connect the DC voltmeter to **TP2001**.
- Connect the RF signal generator to the antenna jack and inject a +40 dBμ signal, then adjust **T2001** and **T2002** in succession several times for minimum DC voltmeter indication.
- Reduce the RF signal level to +20 dBμ, and confirm at least 2.8 V on the DC voltmeter.

IF Notch

- Preset the **NOTCH** control to 12-o’clock, then inject a +30 dBμ signal at 14.2000 MHz to the antenna jack. Select **USB**, then tune the transceiver to 14.20150 MHz (so that a 1500 Hz tone is heard).
- Press the **NOTCH** button, then adjust **VR2005** and **L2004** for minimum S-meter indication.

FM Squelch Threshold

- With the **FM** mode selected, and no signal present, set the **SQL** control to the 11-o’clock position, then adjust **VR2001** so that the squelch just closes.

SSB Squelch Threshold

- With **USB** selected, and no signal present, set **VR3009** to the fully clockwise position.
- Confirm that the **SQL** control is in the 9- to 12-o’clock position when the squelch is just closed.

Tx 2nd Mixer

- Select the **CW** mode, and connect the spectrum analyzer (FCENTER = 70.455 MHz) to **J2008**.
- Key the transmitter, and adjust **VR2006** to minimize the 2nd local spurious (±8.2 MHz from the 2nd local frequency).

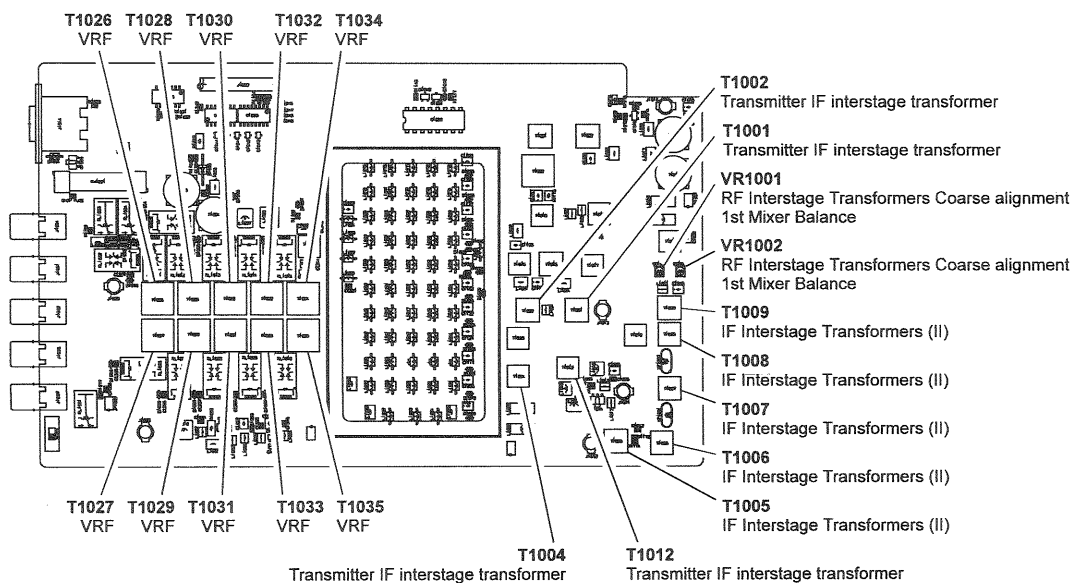

RF Unit Test & Alignment Points

Alignment

Transmitter IF Interstage Transformers

- ❑ Connect the 50 Ω dummy load to the antenna jack. Preset the **RF PWR** control fully clockwise, and **MIC** gain control fully counter-clockwise. Select CW mode.
- ❑ Key the transmitter, and adjust **T1001**, **T1002**, **T2013** ~ **T2015**, and **T2017** ~ **T2019** in succession several times for maximum indication on the ALC meter.

Overcurrent ALC

- ❑ With the inline wattmeter and 50 Ω dummy load connected to the antenna jack, preset **VR3002**, **VR3003**, **VR3008** on the AF Unit and the **RF PWR** control fully clockwise. Set **S3002** on the AF Unit to the “100W” position.
- ❑ Tune the transceiver to 3.500 MHz, and select the **CW** mode. Key the transmitter, and adjust **VR3008** for 240 watts on the wattmeter.

Maximum RF Power Output

- ❑ Preset the **RF PWR** control fully clockwise, and tune the transceiver to 14.2000 MHz. Select the **CW** mode, key the transmitter, and adjust **VR3003** for 200 watts on the meter.

75 W and 10 W RF Power Output

- ❑ Move switch **S3002** from the “100W” to the “50W” position. Connect the in-line wattmeter and 50 Ω dummy load to the antenna jack, select the **CW** mode, and tune to 14.2000 MHz.
- ❑ Set the **RF PWR** control fully clockwise. Key the transmitter, and adjust **VR3007** for 75 watts on the power meter.
- ❑ Recall *menu function 4-0*, and select “10W.” Key the transmitter, and adjust **VR3006** for 10W on the power meter. After adjustment, recall *menu function 4-0*, then select “200W.” Move switch **S3002** back to the “100W” position.

TX Drive Control

- ❑ Set the **RF PWR** control fully counter-clockwise, and select the **CW** mode. Key the transmitter, and adjust **VR3013** so that one segment is displayed on the PO meter.

ALC Meter Sensitivity

- ❑ Set the meter function to ALC, then inject a 1 kHz tone at 4 mV level to the microphone jack. Key the transmitter, and adjust the **MIC** gain control so the meter just begins to deflect.
- ❑ Increase the injection level to 10 mV, and adjust **VR3005** so that the meter deflects to the top edge of the ALC zone.

TX IF Gain

- ❑ Turn the transceiver off. Next, press and hold the **FAST** and **LOCK** keys (near the main VFO knob), then turn the transceiver on.
- ❑ For the frequencies listed in the table below, set the transceiver to **LSB** mode, and inject a 1 kHz tone at 0.5 mV level to the microphone jack. Set the **MIC** gain control fully clockwise. Be sure to check the Menu display for the correct alignment item. TX IF Gain Alignment

TX IF Gain Alignment		
Tune to:	Menu Function 9-2	Key Tx and adjust Main VFO Dial for
1.800 MHz	T IF-018	Minimum ALC Indication
3.500 MHz	T IF-035	Minimum ALC Indication
7.000 MHz	T IF-070	Minimum ALC Indication
10.000 MHz	T IF-100	Minimum ALC Indication
14.000 MHz	T IF-140	Minimum ALC Indication
18.000 MHz	T IF-180	Minimum ALC Indication
21.000 MHz	T IF-210	Minimum ALC Indication
24.500 MHz	T IF-245	Minimum ALC Indication
28.000 MHz	T IF-280	Minimum ALC Indication
29.000 MHz	T IF-290	Minimum ALC Indication

Note: For all adjustments below, set the transceiver to **LSB**, and inject a 0.5 mV, 1-kHz to the **MIC** jack. Set the **MIC** gain control fully clockwise.

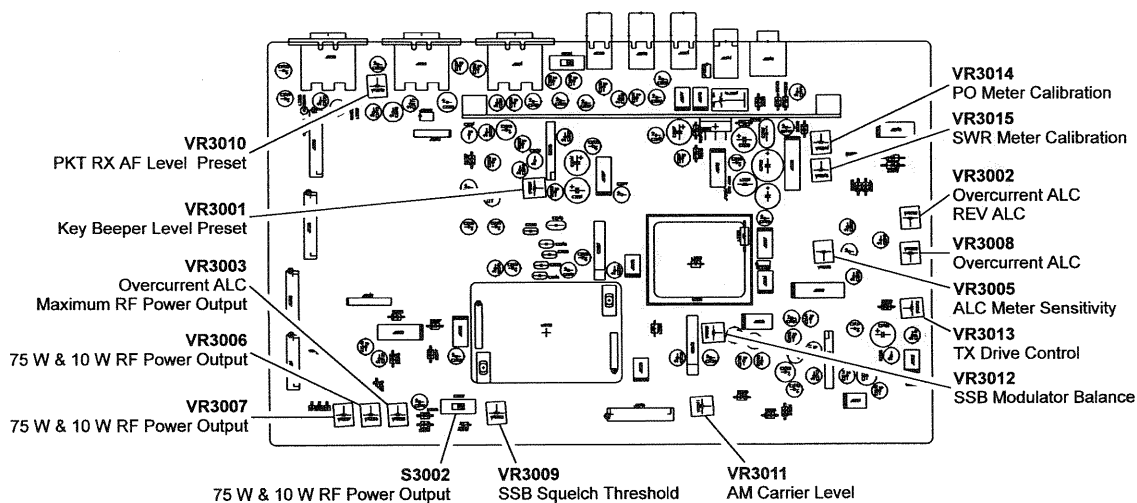

RF Unit Test & Alignment Points

PO Meter Calibration

- ❑ With the wattmeter and 50 Ω dummy load connected to the antenna jack, select the **CW** mode and set the meter to read power output.
- ❑ Key the transmitter, and adjust the **RF PWR** control for 200 watts on the *external* wattmeter. Then adjust **VR3014** so the transceiver's PO meter also indicates 200 watts.

Reverse ALC

- ❑ Connect the 16.6 Ω dummy load (or three 50 Ω loads in parallel) to the antenna jack, preset the **RF PWR** control fully-clockwise, and select the **CW** mode. Key the transmitter, and adjust **VR3002** for 50 watts on the transceiver's PO meter.

SWR Meter Calibration

- ❑ Connect the 16.6 Ω dummy load (or three 50 Ω loads in parallel) to the antenna jack, then preset the **RF PWR** control fully clockwise. Select the **CW** mode, and set the meter to read SWR.
- ❑ Key the transmitter, and adjust **VR3015** so the meter indicates 3.0:1 SWR (within 1 bargraph segment).

IC Meter Calibration Check

- ❑ With the wattmeter and 50 Ω dummy load connected to the antenna jack, select the **CW** mode, and set the meter to read IC. Preset the **RF PWR** control fully clockwise.
- ❑ Key the transmitter, and confirm 10A ~ 18A IC meter indication.

SSB Modulator Balance

- ❑ With the 50 dB attenuator and spectrum analyzer (or 50 Ω dummy load and sampling coupler) connected to the antenna jack, and the **MIC** gain control preset fully counterclockwise, select either **SSB** mode. Alternatively, a separate receiver can be used, with the transceiver connected to the dummy load.
- ❑ Key the transmitter, and adjust **VR3012** for minimum power output (carrier leakage, which should be lower than -50 dB) as indicated on the spectrum analyzer or external receiver.

AM Carrier Level

- ❑ With the wattmeter and 50 Ω dummy load connected to the antenna jack, select the **AM** mode, and set the meter to read ALC. With no microphone input, preset the **RF PWR** control to the fully clockwise position. Key the transmitter, and adjust **VR3011** for ALC meter deflection to the top edge of the ALC zone.

Speech Processor

- ❑ Preset the **T2016** to top edge of the coil case.

COMP Meter Calibration

- ❑ Set the **PROC** and **RF PWR** controls fully clockwise, and press the PROC button to activate the speech processor.
- ❑ Set the meter to read COMP, and preset the **MIC** gain control to the 1-o'clock position. Inject a 1 kHz tone at 2 mV level to the mic jack, and adjust **VR2007** so that the transceiver's COMP meter deflects to the 10 dB mark on the COMP scale.

FM Carrier Frequency

- ❑ Connect the frequency counter to **J2008**, preset the **FM** mic gain control fully counter-clockwise, and select the **FM** mode. Key the transmitter, and adjust **L2026** for 70.455 MHz (± 50 Hz) on the frequency counter.

FM & CTCSS Tone Deviation

- ❑ With the 50 dB attenuator and linear detector (or 50 Ω dummy load and sampling coupler) connected to the antenna jack, select the **FM** mode, and tune to 29.2000 MHz.
- ❑ Set the **FM** mic gain control fully clockwise, and inject a 1 kHz tone at 10 mV level to the mic jack. Key the transmitter, and adjust **VR2009** for ± 2.3 kHz (± 0.1 kHz) on the linear detector.
- ❑ Select the 88.5 Hz (default) subaudible tone, and press the RPT button to activate CTCSS operation. Key the transmitter and with no microphone input, and adjust **VR2008** for 0.5 kHz ± 0.1 kHz on the linear detector.

Transmitter Carrier Point

- ❑ Turn the transmitter off, then press and hold in the **FAST** and **LOCK** buttons (near main VFO knob), then turn the transceiver on.
- ❑ Recall *menu function 9-0* and select "t-LsbcAr" using the SUB VFO-B dial.
- ❑ Select the **LSB** mode and then inject a 1 kHz tone to the mic jack. Adjust the injection level to the point where the ALC meter no longer deflects.
- ❑ Adjust the injection frequency (within 800 ~ 2000 Hz) for peak RF output, then adjust the injection level for 80 W RF output.
- ❑ Set the injection frequency to 350 Hz, and adjust the MAIN VFO-A knob for 20 W RF output.
- ❑ Select "t-uSbcAr" using the SUB VFO-B knob, and select the **USB** mode. Inject a 1-kHz tone to the mic jack, and adjust the injection level to the point where the ALC meter no longer deflects.
- ❑ Adjust the injection frequency (from 800 ~ 2000 Hz) for peak RF output, then adjust the injection level for 80 W RF output.
- ❑ Set the injection frequency to 350 Hz, and adjust the MAIN VFO-A knob for 20 W RF output.

FM Mic Gain

- ❑ With the 50 dB attenuator and linear detector (or 50 Ω dummy load and sampling coupler) connected to the antenna jack, tune to 29.200 MHz, and select FM mode.
- ❑ Inject a 1.8 mV signal at 1 kHz to the **MIC** jack. Key the transmitter, and adjust **VR6814** for 1.75 kHz ± 0.1 kHz on the linear detector.

Alignment

PKT Receiver AF Level Preset

- ❑ Preset **VR3010** fully clockwise. The level should be adjusted by the owner, if necessary.

Key Beeper Level Preset

- ❑ Preset **VR3001** fully counter-clockwise. The “beep” level may be reduced by the owner, if desired.

Headphone Output Level Preset

- ❑ Preset **VR6804 ~ VR6807** to their 12-o’clock positions. The level may be adjusted by the owner, if desired.

Tuning Meter Center Preset

- ❑ Preset **VR6809 ~ VR6811** to their 12 o’clock positions. Select the **CW** mode, and turn the SPOT function on.
- ❑ Connect the DC voltmeter to the cathode of **D6805**, and adjust the **PITCH** control for at least 4.0 V on the DC voltmeter.
- ❑ Connect the DC voltmeter to the “common” lead of **VR6811**, and adjust **VR6811** for 2.7 V (± 0.1 V) on the DC voltmeter.
- ❑ Connect the DC voltmeter to pin 5 of **J6810**, and adjust **VR6810** for 3.4 V (± 0.1 V) on the DC voltmeter.
- ❑ Finally, adjust **VR6811** for a centered tuning meter indication.

Tuning Meter Preset (CW, RTTY and PKT Modes)

- ❑ Recall **menu function 3-5**, and select “**A1-Pitch**” using the MAIN VFO-A knob. Tune to 700 Hz using the **PITCH** knob (“C-700” displayed).
- ❑ Select the **CW** mode, press the **SPOT** key, and adjust **VR6810** for a centered tuning meter indication.
- ❑ Select **menu function 4-2**, select the **RTTY** mode, and tune to 2210 Hz using the MAIN VFO-A knob.
- ❑ Select “**bBEEP-tun**” using the SUB VFO-B knob, and adjust **VR6809** for a centered tuning meter indication.
- ❑ Tune a 2125 Hz beep frequency using the MAIN VFO-A knob, and select the **PKT** mode.
- ❑ Select “**bBEEP-tun**” using the SUB VFO-B knob, and adjust **VR6808** for a centered tuning meter indication.

VOX Gain, ANTI TRIP and Delay Presets

- ❑ Preset **VR6812** (DELAY), **VR6813** (A-VOX) and **VR6812** (VOX) to their 12-o’clock positions. These controls will be adjusted by the owner during setup of the transceiver.

BEEP and SIDETONE Preset

- ❑ Preset **VR5001** (SIDETONE) and **VR5002** (BEEP) to their 10-o’clock positions. These controls may be adjusted by the owner, if desired.

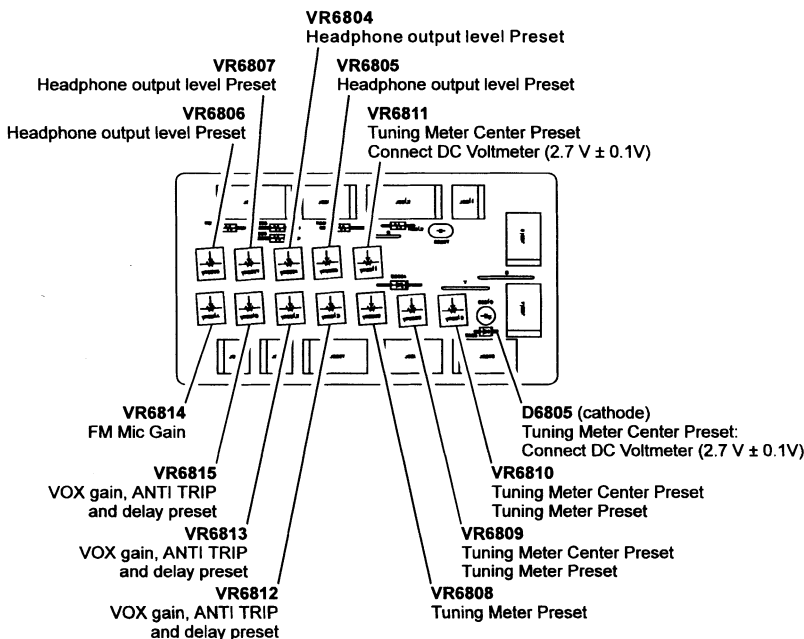

ALC Unit Test & Alignment Points

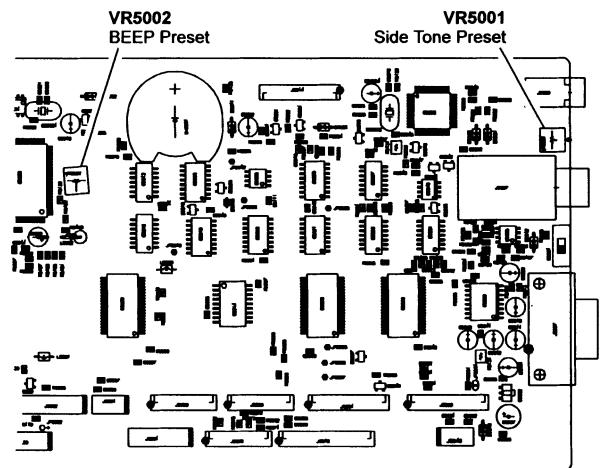

CNTL-1 Unit Test & Alignment Points

Main Receive Signal Circuitry

High-Frequency Circuit

The receive signal enters from ANT connector A or B, selected by relays RL6452/RL6453 on the TUNER-MAIN Unit, and it then passes through t/r relay RL6451 and is fed to connector J1003 on the RF Unit from connector J6454.

The receive signal then passes through the “RX Antenna” antenna switching relay RL1003 and an attenuator (-6 dB, -12 dB; -18 dB when combined) which consists of resistors R1051-R1054 and relays RL1003 and RL1004.

If the VRF feature is engaged (available on 160-20 meters), the signal then enters a narrow band-pass “preselector” filter which consists of relays RL1006-RL1015, coils T1026-T1036, and capacitors C1253-C1264 and C1282-C1285. The preselector, which provides high-Q filtering ahead of any active devices in the receiver circuitry, protects the components in the front end from strong out-of-band energy.

The receive signal then enters a 5th-order Chebyshev low-pass filter (LPF) which consists of coils L1087 and L1088 and capacitors C1035-C1039. After the signal is removed of frequency components of 30 MHz and above, it is fed to one of the band-pass filter (BPF) networks.

The BPF is a 5th-order Chebyshev type filter; a total of 11 different bandpass filters are provided, covering the frequency range 100 kHz ~ 30 MHz in segments of different widths. Depending on the receiver frequency, the appropriate band is selected by diodes **D1008-D1017** (all **1SV271**), **D1018-D1026** (all **1SS356**), **D1027-D1031** (all **1SV271**), and **D1032-D1036** (all **1SS356**). After removal of unwanted frequency components, the incoming RF energy is applied to the high-frequency amplifier circuit.

The RF amplifier consists of a low-band amplifier circuit FET **Q1018** (**3SK131**), a mid-band amplifier circuit FETs **Q1019-Q1022** (all **SST310**), and a high-band amplifier circuit **Q1028** (**SST310**). The appropriate amplifier circuit is selected* by **D1037-D1041** and **D1045** (all **1SS356**). After amplification, the signal is applied to the 1st mixer circuit and/or the sub-receive circuit (RX2 Unit).

* *Note* - If “Flat” is selected in Menu Program 8-4, RF signal input is sent to the mid- band amplifier circuit.

Diodes **D1046** and **D1047** (both **1SS356**), which are connected to the RF amplifier input and output, turn on (off) the amplifier circuit via the front-panel IPO switch.

1st Mixer Circuit/1st IF Circuit

The 1st mixer of the RF Unit consists of junction FETs **Q1010-Q1013** (all **SST310**). The 1st local signal (70.555 ~ 100.455 MHz) from the LOCAL Unit is amplified by **Q1014** (**2SC2053**) and applied to the gates of each FET in the 1st mixer.

The resulting output signal (the difference between the local signal and receive signal) passes through dual monolithic crystal filters (MCF) **XF1001/1002** (**70R12BUF**, BW: ±6 kHz) to obtain

the 1st IF signal having a center frequency of 70.455 MHz. The signal is fed to the 2nd mixer circuit of the IF Unit after it is amplified by FET **Q1009** (**2SK131**).

2nd Mixer Circuit/2nd IF Circuit

The 2nd mixer consists of FETs **Q2020** and **Q2024** (both **2SK302GR**) on the IF Unit. The 2nd local signal (62.24 MHz) from the LOCAL Unit is amplified by **Q2027** (**2SC2812**) and is applied to each FET’s gate in the 2nd mixer.

The output from the 2nd mixer passes through monolithic crystal filter **XF2001**, where it is stripped of unwanted signal components to become the 2nd IF signal (8.215 MHz). A portion of the 2nd IF signal from the mixer output is fed to the FM IF circuit through a noise blanker circuit and buffer-amplifier FET **Q2003** (**2SK302GR**).

The 2nd IF signal that has passed through the MCF enters the noise blanker gate, **D2014** (**1SS226**). It is then routed through either a crystal filter (**XF2002**, **XF2003**, **U2002**, **U2005**) or an attenuator (**R2174**, **R2175**, **R2183**), according to the receiving mode (CW, SSB, or AM), and then it passes onward to the 3rd mixer circuit.

Noise Blanker Circuit

A sample of the 2nd IF circuit is amplified by FETs **Q2009** and **Q2010** (both **3SK131**) on the IF Unit, and then undergoes detection by **D2006** (**1SS226**). This output passes through **R2017** and **R2027**, **C2006**, and **Q2001** (**2SC2812**) to yield an average AGC voltage for controlling the degree of amplification of the above FETs. Noise pulses contained in the output from **D2026** are detected by **D2009** (**1SS270**) and **Q2012** (**2SC2812**) and are used to control the NB Gate.

3rd Mixer Circuit/3rd IF Circuit (IF Notch Circuit)

The 3rd mixer uses double-balanced mixer (DBM) IC **Q2021** (**μPC1037H**) on the IF Unit. The 3rd local signal (8.67 MHz) from the LOCAL Unit is applied to the DBM IC local port after it is buffer-amplified by **Q2028** (**2SC2812**). The signal output from the 3rd mixer passes through a ceramic filter, crystal filter, or mechanical filter (**U2001**, **U2003**, **U2004**, **U2006**, **CF2002**), to become the 455-kHz 3rd IF signal.

The 3rd IF signal, buffer-amplified by **Q2022** (**2SC2812**), passes through a notch frequency control circuit which consists of **L2004**, **C2063**, **C2064**, and **D2020** (**HVU306A**). Attenuation in the IF notch circuit is controlled by **VR2005**. The 3rd IF is then buffer-amplified by **Q2023** (**2SC2812**) and further amplified in two stages by FETs **Q2026** and **Q2029** (both **3SK131**).

The IF signal is then buffer-amplified by **Q2004** and **Q2017** (both **2SC2812**), respectively. The output of **Q2004** is applied to the AF Unit through connector **J2002**, and the output from **Q2017** is sent to the AGC circuit.

AGC Circuit

The AGC circuit consists of **D2012** and **D2013** (both **1SS198**), transistor **Q2018** (**2SC2812**), etc. on the IF Unit. Output from the

Circuit Description

AGC circuit is fed back to the RF AGC circuit that consists of FETs and PIN diodes of the IF amplifier stages, by which the output is controlled.

FM IF Circuit/FM Demodulator Circuit

The 2nd IF signal that has passed through buffer-amplifier FET **Q2003** on the IF Unit, and the 3rd local signal (8.67 MHz) that has been buffer-amplified by **Q2028**, are fed to IC **Q2015 (MC3372ML)** for FM demodulation.

The FM demodulator IC contains a mixer, limiter amplifier, filter amplifier, squelch trigger, and demodulator. The IF input signal is mixed with the 3rd local signal, band-limited by ceramic filter **CF2001 (CFWS455G)**, BW: ± 4 kHz, amplified by the limiter amplifier, and demodulated into an audio signal by the demodulator. It then passes through a filter (R2028, C2021) and connector J2004 en route to the AF Unit. The signal then enters analog switch IC **Q3001-3 (BU4066BF)** through a de-emphasis circuit which consists of R3060 and C3052.

The squelch circuit selectively amplifies the noise component of the demodulator output by the filter amplifier inside the FM IC and the active band-pass filter consisting of an externally attached resistor and capacitor. This circuit uses a signal detected by **D2001 (1SS270)**.

SSB/CW Demodulator Circuit

The 3rd IF signal from the IF Unit is applied to the SSB demodulator of **Q3007 (μ PC1037H)** on the AF Unit, which produces audio by applying the carrier signal from the DDS-CAR Unit to **Q3007** after buffering by **Q3020 (2SC2812)**. Similarly, the CW signal is demodulated by a carrier signal which is offset by the "Pitch" frequency.

The demodulated SSB and CW signals are each stripped of high-frequency components by an active low-pass filter consisting of op-amp IC **Q3008-2** and IC **Q3008-1 (M5218AFP)**. Then, they enter analog switch IC **Q3001-2** and IC **Q3001-4 (BU4066BF)**.

AM Demodulator Circuit

The 3rd IF signal from the IF Unit is applied to I-DET Unit **U3003** on the AF Unit, from which it enters IC **Q3703 (MC13020M)** for AM demodulation.

The IC for AM demodulation consists mainly of an envelope detector, VCO, phase shifter, synchronous detector, and DC/AC detector. From the IF signal that is fed to the IC, the envelope detector output and synchronous detector output are picked up.

The output from the demodulator circuit passes through analog switches **Q3701-1** and **Q3701-2** for switching between the synchronous detector output and envelope detector output. It then enters analog switch IC **Q3001-1 (BU4066BF)** after removal of the high-frequency components by an active low-pass filter which consists of op-amp IC **Q3013-1 (M5218AFP)** on the AF Unit.

Low-Frequency Amplifier Circuit

The demodulated signal that is selected by one of analog switches IC **Q3001-1** to IC **Q3001-4** on the AF Unit (according to the receiving mode) passes through the squelch switch, audio muting FET **Q3002 (2SK160)**, low-frequency amplifier transistor **Q3006 (2SC2812)**, electronic volume IC **Q3005 (M51131L)**, op-amp IC **Q3014-1 (M5218AFP)** for buffer-amplification, and IC **Q3022 (TDA2003V)** for low-frequency power to drive the internal or external speaker with a maximum output of approximately 1.5 W. The signal that passes through electronic volume IC **Q3005** is also sent to the headphone terminals after it is amplified by headphone amplifier IC **Q3015-1 (M5218AFP)**.

Transmit Signal Circuitry

Microphone Amplifier Circuit

The audio signal from microphone jack J9421 on the MIC Unit is passed through connector JP9421 and the DISPLAY Unit's connectors (J5528 and J5529), is amplified by transistor **Q3048 (2SC2812)** on the AF Unit, and then is applied to electronic volume IC **Q3044 (M51131L)**, which is controlled by the MIC knob on the panel.

The output (audio signal) from the electronic volume control is amplified by **Q3045 (2SC2812)** and fed to balanced modulator IC **Q3046 (μ PC1037H)** through the buffer-amplifier transistor **Q3043 (2SC2812)**.

During FM transmission, the audio signal is routed to connector J2011 inside the IF Unit after its volume is adjusted by VR6814 on the ALC Unit. The audio signal that has passed through the pre-emphasis circuit consisting of C2201 and R2228 on the IF Unit is mixed with a tone signal from the CNTL Unit, and is amplified and limited by op-amp IC **Q2049-2 (M5223AFP)** of the IDC circuit. The audio then passes through the splatter filter (secondary active low-pass filter) formed by op-amp IC **Q2049-1**, R2229, and R2230, plus C2119 and C2206, and is then fed to the frequency-modulator circuit inside the IF Unit through VR2008 and VR2009 for setting of the frequency deviation.

SSB Modulator Circuit

The carrier signal appropriate to the transmitting mode (LSB or USB) is applied from the CAR-DDS Unit to balanced modulator IC **Q3046** on the AF Unit, and is modulated by microphone audio.

The balanced modulator produces the upper and lower side bands and carrier signal. The carrier and audio signal are suppressed and the carrier balance is adjusted by VR3012. As a result, the output signal obtained is a DSB signal with a carrier suppression ratio of 35 dB or more.

The DSB modulated signal (1st IF signal: 455 kHz) then passes through mechanical filter **XF9801** inside the SSB-FIL Unit on the IF Unit, stripping residual carrier and the undesired sideband; the signal then passes as an SSB signal through buffer-amplifier **Q3049 (2SC2812)**, connector J3026, and the IF Unit's connector J2009.

AM Modulator Circuit

As in the SSB modulator circuit, a carrier signal appropriate to the transmitting mode (AM) from the CAR-DDS Unit and an audio signal from the microphone are applied to balanced modulator IC **Q3046** on the AF Unit.

The control signal from CPU IC **Q5008 (M37702M)** in the CNTL Unit causes a voltage of AM 9 V to be sent from transistor array IC **Q5025 (TD62793F)**. This voltage is applied via VR3011 and **D3018 (DAN202K)** to IC **Q3046**, causing the balanced modulator to lose balance. The restored carrier signal and modulated signal are then fed to the Tx mixer via ceramic filter **CF2002 (CFWS455HT)** inside the IF Unit.

Frequency Modulation Circuit

The FM circuit uses a voltage controlled crystal oscillator (VCXO) consisting mainly of IF Unit oscillator **Q2044 (2SC2812)**, X2001, varactor **D2049 (HVU306A)**, and L2026. The VCXO has a center frequency of 8.215 MHz.

The FM signal is produced by applying a signal from the FM microphone amplifier circuit to varactor **D2049** and varying the crystal oscillator load capacity in proportion to the signal voltage. The FM signal is fed to gate 1 of 2nd IF circuit FET **Q2036 (3SK131)** via **Q2043 (2SC2812)** for buffer amplification.

CW (A1) Signal Generator Circuit

When the transmitting mode is CW (A1), the control signal from CPU IC **Q5008** in the CNTL Unit causes a CW 9 V voltage to be sent from transistor array IC **Q5025**. While microphone audio is cut off by **Q3050 (2SC4047)**, the voltage is applied to balanced modulator IC **Q3046** via **D3018**, providing a carrier from the balanced modulator for input to the transmit signal circuit of the IF Unit.

1st IF Circuit/1st Mixer Circuit

The 455 kHz 1st IF signal from the modulator circuit is band-limited by the IF Unit's ceramic or mechanical filter **CF2002, U2001 (XF9801)** according to the selected mode (CW, SSB, or AM). It is then buffer-amplified by FET **Q2037 (2SK160)** and fed to 1st mixer IC **Q2030 (μPC1037H)**.

The IF Unit's double balanced mixer IC **Q2030 (DBM)** is used as the 1st mixer. A local signal (8.67 MHz) from the LOCAL Unit which is buffer-amplified by transistor **Q2028 (3SK131)** and fed to the local port of DBM IC is mixed with the 455 kHz 1st IF signal to produce an 8.215 MHz 2nd IF signal.

2nd IF Circuit/2nd Mixer Circuit

The 2nd IF signal passes through either the IF Unit's crystal filter **XF2002** or attenuator (R2174, R2175, R2183), whichever is appropriate to the selected mode (CW, SSB, or AM). It is then amplified by FET **Q2036 (3SK131)** and fed to the 2nd mixer circuit.

The 2nd mixer consists of the IF Unit's FETs **Q2033** and **Q2038** (both **2SK302GR**). A 2nd local signal (62.24 MHz) from the LOCAL Unit is amplified by **Q2027 (2SC2812)** and fed to each FET's

gate. The signal that is produced by the 2nd mixer is removed of unwanted signal components as it passes through a filter, formed by T2014/T2017 and C2227, to obtain a 70.455 MHz 3rd IF signal.

3rd IF Circuit/3rd Mixer Circuit

The 3rd IF signal passes through T1001, is amplified by FET **Q1001 (SST310)**, then is fed to the 3rd mixer circuit **D1001 (HSB88WSTR)** via T1002. There it mixes with a local signal (72.255 ~100.455 MHz) generated by the LOCAL Unit to produce a transmit signal (1.8 MHz to 30 MHz) at the desired operating frequency.

High-Frequency Transmit Preamplifier Circuit

The transmit signal is passed through a low-pass filter which consists of L1002/L1003 and C1008-C1012, is amplified by **Q1002 (2SC3356)**, and is passed onward to the PA Unit via buffer amplifiers **Q1022 (2SC3356)** and **Q1023 (2SC2954)**, exiting via connector J1005.

Power Amplifier Circuit

The transmit signal from the RF Unit arrives at connector J6301 of the PA Unit.

The transmit signal (1.8 MHz to 30 MHz) delivered to the PA Unit is amplified by pre-driver **Q6301 (2SC2166)**, driver **Q6302 (BLF145)** and final amplifiers **Q6304/Q6305 (BLF147)**, and exits from connector J6304 en route to the LPF-1 Unit.

Low-Pass Filter (LPF) Circuit

The transmit signal from the power amplifier circuit is sent to connector J6001 of the LPF-1 Unit and passed through a low-pass filter consisting mainly of RL6001-RL6014, L6001-L6014, and various capacitors. The LPF is a 5th-order Chebyshev type filter, utilizing seven different sections for the various amateur bands at 1.8 ~ 30 MHz.

The low-pass filtered transmit signal is fed to the ANT Unit through directional coupler L6015 and connector J6005.

The directional coupler, which consists mainly of L6015, TC6001, and C6061, samples a part of the transmission power to detect forward power and reflected power. A DC voltage corresponding to the relative forward/reflected power is produced by **D6001-D6004** (all **HRF32**), and is used for automatic level control (ALC).

ALC Circuit

The output from the directional coupler is routed from connector J6003 through connectors J6810/J6814 in the ALC Unit and applied to the ALC circuit via connector J3018 in the AF Unit.

The ALC circuit consists of an op-amplifier circuit for amplifying the forward and reflected voltage, a time-constant ALC amplifier, and a transmit signal control circuit on the IF Unit.

The forward voltage from connector J3018 in the AF Unit is added with a DC control voltage which passes through the output power control, VR3003 (for setting transmission output, etc., on

Circuit Description

the panel), and is then applied to op-amp IC **Q3026-1 (M5218AFP)**.

The reflected voltage is added with a DC control voltage which passes through VR3008, and is then applied to op-amp IC **Q3026-2**. During high SWR conditions (SWR 3:1 or more), transmitter output is reduced and a “High SWR” warning appears, thus protecting the PA Unit for potential damage.

The op-amp output passes through **D3009 (1SS184)** where the forward and reflected output from the op-amp are mixed and fed to the ALC amplifier, which contains a time-constant circuit.

The ALC amplifier amplifies the forward and reflected-wave output via transistor **Q3025 (2SC2812)**. This output then passes through a fast-attack, slow-delay RC time-constant circuit consisting of R3083/R3087 and C3069/C3157 for input to the Tx signal control circuit via connector J3015 and J2004 on the IF Unit.

The TX control circuit adjusts the IF amplifier gain via gate 2 of FET **Q2036** of the 8.215 MHz IF amplifier circuit to prevent the Tx output from exceeding the preset level.

Keying Circuit

When the onboard electronic keyer is used in the CW mode, the bias of **Q1001**, 2nd mixer FETs **Q2033/Q2038**, and 3rd mixer **D1001** is controlled via NAND gate IC **Q1006 (μPD4011BG)** to generate CW.

To limit key clicks, the waveform is optimized by time-constant circuits, such as **D1002 (BAS316)**, R1016, and C1018 of the bias control circuit.

PLL Frequency Synthesizer (Main)

The PLL Frequency Synthesizer consists mainly of a master reference oscillator circuit, 2nd local oscillator circuit, 3rd local oscillator circuit, DDS-PLL/DDS-SUB/DDS-CAR units which digitally synthesize carrier outputs, and a PLL circuit which contains a voltage controlled oscillator (VCO).

Master Reference Oscillator Circuit

The master reference oscillator uses a TCXO (oscillation frequency: 10.48576 MHz) on the REF Unit.

The reference oscillator signal passes through a low-pass filter composed of C4715/C4716, and L4702. It is then fed to the LOCAL Unit via J4703, and also to the RX2, AF, and DSP-D Unit as the reference oscillation signal.

DDS-CAR Unit/DDS-PLL Unit/DDS-SUB Unit

DDS ICs **Q3601 (TC23SC030AF)**, **Q4502 (FQ7928)**, and **Q4603 (TC23SC030AF)** of the DDS (Direct Digital Synthesizer) Units each contain a shift register, selector, phase accumulator, and ROM.

The reference oscillation frequency (10.48576 MHz) that is delivered to each of the DDS Units is applied to each DDS IC after amplification by transistors **Q3603/Q4503/Q4601 (all 2SC2812)**.

The DDS outputs contain digital amplitude data corresponding to serial frequency data from CPU IC **Q5008** of the CNTL Unit. The digital amplitude data is D/A-converted by ladder resistors RB3601/RB4501/RB4601 and passes through buffer amplifier **Q3602, Q4501, Q4602 (all 2SC2812)** and a Chebychev LPF to generate a sine wave. The DDS frequency range is 453.5 ~ 466.74 kHz (cf = 455.0 kHz) for the CAR-DDS, 373.08 ~ 291.16 kHz for the DDS-PLL, and 907.88 kHz ±620 Hz for the DDS-SUB.

3rd Local Oscillator Circuit

The 3rd L.O. circuit generates a 1.81576 MHz signal by doubling the 907.88 kHz output from the SUB-DDS Unit on the LOCAL Unit using a circuit composed of **Q4036 (2SC2812)**, T4010, capacitors C4163, C4164, C4170, and coil L4038. The doubled signal is sent to mixer **Q4027 (μPC1037)**.

At the mixer, the 1.81576 MHz input signal is mixed with the 10.48576 MHz reference oscillation signal. The mixer output is stripped of unwanted frequency components by T4009 and monolithic filter XF4001 to generate the 8.67 MHz 3rd L.O. signal.

This signal is amplified by **Q4029 (2SC2812)** and T4008 and passes through buffer amplifier **Q4017 (2SC2812)** and a LPF composed of capacitors C4098, C4099, C4172, and coil L4022 for input to the IF Unit via connector J4003.

2nd Local Oscillator Circuit

The 2nd L.O. circuit is a Hartley-type overtone oscillator circuit (frequency: 62.24 MHz) composed of FET **Q4003 (2SK210GR)**, T4001, and X4001 on the LOCAL Unit. The signal then passes through amplifier Q4012 (**2SC2714Y**), T4006, T4007, and C4043, for input to the IF Unit via connector J4002.

1st Local Oscillator Circuit

VCO output is buffer-amplified by **Q4004** and **Q4005 (both 2SC2714Y)** and passes through a LPF composed of coils L4003/L4004 and capacitors C4028, C4029, and C4033-C4035. It is then fed to the Tx/Rx frequency mixer circuitry of the RF Unit via connector J4001.

PLL Circuit

The PLL circuit is a frequency mixing type composed of a VCO, mixer, PLL IC, and loop filter.

The VCO consists of four circuits (VCO1, VCO2, VCO3, and VCO4), with a frequency range of 70.555 ~ 100.455 MHz divided into four bands, allocated to the four VCO circuits. The range of VCO1 is further divided by a circuit which shifts the oscillation frequency. VCO1-VCO4 consist mainly of FETs **Q4009, Q4016, Q4023, and Q4032 (all 2SK210BL)**, diodes **D4001, D4002, D4004, D4005, D4007, D4008, D4010, and D4011 (all HVU306A)**, trimmer capacitors TC4001-TC4004, and coils L4013, L4020, L4029, and L4035.

The VCO switching signal from connector J4004 is used to drive switching transistors **Q4013, Q4021, Q4026, and Q4037 (all 2SC4047)** to switch the source terminal of the oscillator FET.

VCO1 uses the VCO0 control signal to drive switching transistors **Q4039 (2SA1563)** and **Q4040 (2SC4047)**, applying a forward bias to **D4013 (1SV271)**, and switching C4173 into the oscillator circuit, producing a frequency shift.

The 70.555 ~ 100.455 MHz VCO signal is fed to mixer **Q4001 (μPC1037)** via buffer amplifier FET **Q4007 (2SK210GR)** and buffer amplifier **Q4006 (2SC2714Y)**.

The 3rd local signal (8.67 MHz) is buffer-amplified by **Q4022** and passed through the LPF composed of capacitors C4112, C4113, and C4118-C4120, coils L4026/ L4027; the reference oscillator signal (10.48576 MHz) from the TCXO Unit that has been amplified by transistor **Q4025 (2SC2812)** is divided into 2.62144 MHz by the 1/4-frequency divider **Q4020 (TC74HC74AF)**, and passes through a low-pass filter composed of capacitors C4105, C4106, and C4108-C4110 and coils L402/L4025; these two signals are applied to mixer **Q4019 (SN16913)** to obtain a 6.04856 MHz signal.

This 6.04856 MHz signal is stripped of unwanted signal components by ceramic filter **CF4002 (SFT6.0MA)** and fed to mixer **Q4010 (SN16913)**, together with the 291.16 ~ 373.08 kHz output frequency of the DDS-PLL Unit, to obtain a 5.67548 ~ 5.75740 MHz signal. This signal passes through **CF4001 (SFT-5.74MA)** to mixer **Q4002 (μPC1037H)**, together with the 62.24 MHz 2nd L.O. output that has been buffer-amplified by **Q4011 (2SC2714Y)**, to obtain a 67.91548 ~ 67.99740 MHz signal.

This signal passes through a BPF composed of T4003-T4005 and C4011/4012, is buffer-amplified by **Q4008 (2SC2714Y)**, and is fed to mixer **Q4001 (μPC1037H)** via transformer T4002.

The mixer output from **Q4001** (2.62144 ~ 32.52224 MHz) passes through a 9th-order Chebychev LPF composed of L4007-L4011, C4048-C4052, and C4061-C4066, and is amplified by FETs **Q4015 (2SK210GR)** and **Q4018 (2SC2714Y)**, and then is delivered to PLL IC **Q4024 (MB87088APF)**.

At the same time, the 10.48576 MHz reference oscillator signal from the TCXO Unit is fed to PLL IC **Q4024** after it is amplified by **Q4030 (2SC2812)**, the signal and passes through buffer amplifier **Q4028 (2SC2812)** and a LPF composed of C4148, C4149, and L4033.

The phase of the reference frequency and that of the signal input to PLL IC is compared, and a signal whose pulse corresponds to the phase difference is produced. The VCO frequency is controlled by a loop filter which consists of an active filter composed of **Q4033 (2SK208Y)**, **Q4034 (2SC2812)**, **Q4038 (2SC2812)**, R4089, R4091, and C4153 and a secondary lag filter composed of C4059, C4095, C4128, C4160, C4158, and R4088.

Carrier Oscillation Signal Circuit

The 453.5 ~ 466.74 kHz (cf = 455.0 kHz) carrier output from the DDS-CAR Unit passes through buffer amplifier **Q3020 (2SC2812)** and a LPF composed of C3063, C3064, and L3002. The signal path is switched by **D3003** and **D3005** (both **1SS226**) during Tx/Rx so that the signal is properly delivered to balanced modulator IC **Q3046** and SSB detector **Q3007**.

RX2 Circuit

Receive Signal Flow

A portion of the receive signal from the RF Unit may be delivered to J8002 of the RX2 Unit via J1010. It then passes through T8008 and is fed to 1st mixer FETs **Q8022** and **Q8027** (both **SST310**). The 47.31 ~ 77.21 MHz 1st L.O. signal output from the RX2 PLL circuit is passed to the 1st mixer. The resulting 47.21 MHz 1st IF signal then passes through monolithic filter **XF8001 (47G10AU, BW: ±20 kHz)**, is amplified by **Q8024 (3SK131)**, and is then fed on to the 2nd mixer circuit.

The 46.755 MHz 2nd L.O. and the 1st IF signal are mixed in **Q8023** and **Q8026** (both **2SK302GR**) to generate a 455 kHz 2nd IF signal. This signal is then fed to noise-blanker noise amplifier **Q8008 (3SK131)**, noise gates **D8010** and **D8028** (both **1SS270**), and the FM signal buffer amplifier **Q8001 (MC3372ML)**, respectively.

The 2nd IF signal, now removed of noise by the noise gates, is passed through either **CF8002**, **CF8003**, or **U8001** to become the desired signal component. It is then amplified by FETs **Q8048** and **Q8049** (both **3SK131**) and is fed to the SSB demodulator circuit through a buffer amplifier.

The 2nd IF signal that has been delivered to the SSB demodulator circuit is fed to IC **Q8057 (μPC1037H)**, together with a carrier signal from the RX2 CAR-DDS Unit, and demodulated into an audio signal.

The demodulated audio signal is removed of wide-band frequency components as it passes through buffer amplifier transistor **Q8017 (2SC2812)** and active LPF **Q8013 (M5218AFP)**. It is then passed to analog switch **Q8006 (μPD4052BG)**.

The signal that has passed through the buffer amplifier is fed on to the AM detector circuit and AGC circuit. An AM signal detected by **D8014 (2SC2812)** is fed to analog switch **Q8006**.

The audio signal that has passed through analog switch **Q8006** then passes through mute switch FET **Q8002 (2SK160)**, and is amplified by **Q8015 (2SC2812)**, before input to the electronic volume control on the AF Unit via connector J8001.

AGC Circuit Operation

The receive signal that has passed through buffer amplifier **Q8029 (2SC2812)** is rectified by AGC detector **D8017** and **D8008** (both **1SS188**) and fed to control gate 2 of FETs **Q8024**, **Q8048**, and **Q8049** (all **3SK131**) by transistor **Q8021 (2SC2812)**. This signal is also amplified by op-amps **Q8005** and **Q8011** (both **M5223AFP**) for S-meter and squelch control.

RX2 PLL Frequency Synthesizer

The 2nd L.O. circuit is a Hartley-type overtone oscillator circuit (frequency: 46.755 MHz) composed of FET **Q8046 (2SK210GR)**, crystal X8001, and transformer T8018 (all on the RX-2 Unit).

The oscillation signal from this circuit is fed to the 2nd mixer

Circuit Description

via **Q8044 (2SC2714Y)** and T8017/T8016. Like the main PLL circuit, the PLL circuit is a frequency mixing type composed mainly of a VCO, mixer, PLL IC, and loop filter.

The VCO consists of four circuits (VCO1 through VCO4). The 47.31 ~ 77.21 MHz oscillation frequency range is divided into four bands, which are allocated to the four VCO circuits.

VCO1 to VCO4 are composed of oscillator FETs **Q8034, Q8047, Q8051, and Q8058** (all **2SK210BL**), variable-capacity diodes **D8021, D8024, D8027, and D8031** (all **HVU306A**), and oscillator coils L8007, L8010, L8020, L8024. The VCO switching signal from connector J8003 drives switching transistors **Q8040, Q8050, Q8056, and Q8063** (all **2SC4047**) to switch the source line of each oscillator FET.

The oscillation signal (47.31 ~ 77.21 MHz) from the VCO is fed to mixer **Q8043 (μPC1037H)** through buffer amplifier FET **Q8041 (2SK210GR)** and buffer amplifier transistor **Q8042 (2SC2714Y)**.

The reference oscillator signal (10.48576 MHz) from the LOCAL Unit that has been amplified by **Q8066 and Q8060** (both **2SC2812**) and divided into 5.24288 MHz signals by **Q8054 (TC74HC74AF)** is fed to mixer **Q8055** (SN16913) through a LPF composed of C8152, C8153, C8164, C8165, C8166, L8012, and L8013.

At the same time, the 286.28 ~ 364.20 kHz output from the RX2 PLL-DDS Unit is fed to mixer **Q8055** to obtain a 5.52516 ~ 5.60708 MHz signal.

This signal passes through ceramic filter **CF8004 (SFT5.57MA)** and is fed to mixer **Q8038 (SN16913)**, together with the 46.755 MHz output of the 2nd L.O. that has been buffer-amplified by **Q8045 (2SC2714Y)**, to produce a 41.14792 ~ 41.22984 MHz signal. This is then passed through a BPF composed of T8013, T8014, and C8087, is amplified by **Q8037 (2SC2714Y)**, and then is fed to mixer **Q8043** via T8012.

The output of mixer **Q8043** ranges from 6.1440 ~ 36.0488 MHz, and passes through a 9th-order Chebyshev LPF which is composed of coils L8015-L8019 and capacitors C8157-C1861 plus C8168-C8173. This is passed to PLL IC **Q8061 (MB87086AFP)** after it is amplified by FET **Q8053 (2SK210GR)** and transistor **Q8052 (2SC2714Y)**.

At the same time, the 10.48576 MHz reference oscillator signal from the LOCAL Unit is also passed to PLL IC **Q8061** via buffer amplifier **Q8064** after amplification by **Q8065** (both **2SC2812**).

The phase difference is compared between the reference frequency and the frequency of the signal input to the PLL IC, and a pulse corresponding to the phase difference is developed to control the VCO frequency by a loop filter consisting of an active filter at FET **Q8059 (2SK208Y)**, transistor **Q8062 (2SC2714Y)**, and a secondary lag filter composed of a resistor and capacitor.

The controlled VCO output is amplified by **Q8035 (2SC2714Y)** and **Q8036 (2SC2053)** and passes through a LPF

composed of coils L8005/L8006 and capacitors C8098, C8099, and C8104-8106. It is then fed to the 1st mixer circuit through an attenuator.

DSP Circuit

The DSP circuit consists mainly of DSP (Digital Signal Processor) IC **Q7101 (μPD77016GM)**, a AD/DA converter IC, and filter circuit. The functions performed by this circuit are SSB and AM demodulation, auto-notch, noise reduction, audio filtering, etc. in the receiving system and SSB generation/modulation and audio equalizing on the transmit side.

Analog-Digital Converter Circuit

(Transmission System)

The audio signal from the microphone that has passed through electronic volume control **Q3044 (M51131L)** in the AF Unit is fed to the DSP-A Unit through connectors J3037/J7001. It then passes through a 5th-order active HPF (cut-off frequency = 80 Hz) composed of op-amp ICs **Q7004-1/Q7004-2 (μPC457G2)**, R7001-7004, R7007, and C7001, C7002, C7004-7006 to eliminate unwanted frequency components below the cut-off frequency.

The signal then passes through a inverting/non-inverting buffer amplifier circuit composed of op-amp ICs **Q7005-2 to Q7005-4 (NJM3403AM)** prior to input to A/D converter IC **Q7001 (AK4501)**, where it is converted into a 16-bit digital signal. As 16-bit serial data, this signal is transmitted to DSP IC **Q7101** on the DSP-D Unit via connector J7003.

Digital-Analog Converter Circuit

(Transmission System)

The serial digital data input to the D/A converter IC **Q7001** is converted into an analog signal and passed through a differential amplification type tertiary LPF (cut-off frequency $f_c = 18$ kHz) composed of op-amp ICs **Q7007-1/Q7007-2 (μPC457G2)**, R7037-R7043, and C7043-C7046 to suppress out-of-band energy, random noise, etc. The signal is then fed to the AF Unit as an audio signal or SSB signal of 10.24 kHz (suppressed carrier) via connector J7001.

Digital Signal Processor Circuit (Transmission System)

In the transmission system, this circuit has a microphone equalizing function and digital modulator function. The A/D-converted signal data is subjected to tone quality processing and is fed to the digital modulator. When desired, it is possible to disable microphone equalization and digital modulation. The serial audio data or SSB data processed by the DSP IC is fed to the D/A converter in the DSP-A Unit via connector J7103.

The signal from the DSP Unit is fed to balanced modulator IC **Q3048**. When the DSP-enabled SSB modulation function is used, the balanced modulator IC operates as a double balanced mixer (frequency mixer). In this case, a carrier (local) signal (LSB = 466.74 kHz, USB = 463.74 kHz) generated by the DDS-CAR Unit and SSB signal of 10.24 kHz suppressed carrier apply a mixed differential

frequency output of 455 kHz to ceramic filter **CF2002** via connector J2009 on the IF Unit. Thus, this circuit performs the same operations as the analog circuit, but with greatly reduced noise.

When only the equalizing function is used in the A3 mode, the circuit operations after balanced modulator IC **Q3046** are the same as those of the analog circuit.

Analog-Digital Converter Circuit (Receiving System)

The audio signal passing through balanced modulator IC **Q3007** in the AF Unit, or the SSB signal of 10.24 kHz (suppressed carrier) is fed to the DSP-A Unit via connectors J3037/J7001. It then passes through an inverting/non-inverting buffer amplifier circuit composed of op-amplifier IC **Q7006-2**, then it flows to **Q7006-4 (NJM3403AM)**, and finally is fed to A/D converter IC **Q7001**, where it is converted into a 16-bit digital signal. As 16-bit serial data, this signal is fed to DSP IC **Q7101** in the DSP-D Unit via connector J7003.

Digital-Analog Converter Circuit (Receiving System)

The serial digital data that is delivered to the D/A converter IC **Q7001** is converted into analog data and passed through a differential amplification type tertiary LPF (cut-off frequency = 18 kHz) composed of op-amp ICs **Q7008-1/Q7008-2 (μPC457G2)**, R7037-R7043, and C7043-C7046 to suppress out-of-band quantization noise, etc. It is then fed to the AF Unit as an audio signal via connector J7001.

Digital Signal Processor Circuit (Receiving System)

During receive, this circuit performs audio processing and SSB/CW/AM demodulation. The A/D-converted signal data is subjected to digital demodulation and audio processing. When appropriate, it is possible to disable the digital demodulation and audio processing.

When the DSP demodulation function is used, balanced mixer IC **Q3007** of the AF Unit operates as a double balanced mixer (frequency mixer). In this case, the 3rd IF signal (455 kHz) from the IF Unit is mixed with a carrier (local) signal of the frequency ($f_{LSB} = 466.74$ kHz, $f_{USB} = 463.74$ kHz) generated by the DDS-CAR Unit to produce a differential frequency of 10.24 kHz. The audio data processed by DSP IC is sent as serial data to the D/A converter in the DSP-A Unit.

Control Circuitry

Microprocessor Circuit

The microprocessor circuit, which is composed of CPU IC **Q5008 (M37702E8BPF)** and EEPROM IC **Q5024 (M24C16-VMNS)**, performs various types of processing, such as control signals, serial I/O, A/D conversion, dial counter circuit control, key input, and display functions.

The EEPROM memorizes various parameters and settings (transmission frequency range, transmission output control) and carrier points according to the transceiver version and the contents of memory channels.

Reset Circuit

The reset circuit consists mainly of CNTL Unit ICs **Q5005 (M51945BPF)**, **Q5022 (2SC4047)**, and **Q5039-5 (TC74HC04AF)**, capacitors, and resistors. This circuit controls the power-down input port, CPU reset input, keyer CPU, and related circuits.

Dial Counter Circuit

The dial counter circuit consists of two VFO dials, the MEM dial, the CLAR dial, and ICs **Q5026** and **Q5027 (both FQ7927)**. This circuit detects a two-phase pulse having a phase difference of 90 degrees and delivers it to CPU IC **Q5008** as 8-bit parallel data.

Control Circuit

The control circuitry consists of CNTL Unit ICs **Q5023**, **Q5025**, **Q5028-Q5039**, etc. This circuitry controls the operation of various switches, filters, transmit/receive modes, VCOs, bandswitching, and the input of signals.

Serial Data Communication Circuit

Data transfer to the PLL IC, DDS-PLL, SUB, CAR, RX2-PLL, RX2-CAR Unit, indicators, keyer, DSP, etc. is performed by a 3-wire system clock synchronous communication, whereas internal ANT tuner and CAT serial signals are transferred by 2-wire asynchronous communications.

Various types of data, such as operating frequency, mode, and display data, are processed by CPU IC **Q5008** and transferred as serial signals to the appropriate devices by ICs **Q5013 (TC74HC04AF)**, **Q5018 (TC74HC04AF)**, **Q5020 (μPD74HC238GS)**, **Q5021 (μPD74HC238GS)**, and **Q5037 (TC74HC32AF)**.

The CAT (external computer control) signals are converted to RS232 interface standard levels by IC **Q5006 (ADM232LJR)** and exit from pin 9 of DB-9 connector J5007.

Key Matrix Circuit

The key matrix circuit consists of DISPLAY Unit ICs **Q5506** and **Q5507 (both MC14028BPF)**, **D5503-D5517 (all DAN202K)**, and the panel key switches arranged on the matrix. When a key is pressed, this circuit reads the input data for processing by the CPU.

Analog-Digital Converter Circuitry

Forward and reflected-wave voltage, ALC, power supply, S-meter, COMP meter, IF SHIFT/WIDTH VR, DSP switch, PITCH VR, Shuttle Jog, REMOTE terminal, etc. are selected by CNTL Unit ICs **Q5009/Q5010 (both MC14053BP)** and **Q5038 (MC14053BFR)**, and are fed to the A/D port of CPU IC **Q5008** for conversion into digital values to be processed.

The individual voltages, converted into digital values, are displayed as PO, SWR, ALC, IC, VCC, and S-meter indications on the LCD panel.

Circuit Description

LED Drive Circuit

The LED drive circuit consists of KEY Unit ICs **Q9501** and **Q9503** (both **NJU3712M**), and the LEDs. This circuitry converts serial data from the CPU into parallel data, and drives (turns on/off) the appropriate LEDs.

LCD Circuit

Data processed by the CPU IC is sent as serial data to LCD driver ICs **Q5501-Q5504** (all **LC75821E**) of the DISPLAY Unit to drive LCD display **DS5501**. A cold cathode tube and exclusive DC-DC inverter unit are used for back lighting of the LCD. The inverter unit supply voltage is controlled by a dimmer circuit.

CTCSS Tone Generator Circuit

The CTCSS tone generator circuit consists mainly of CPU IC **Q5008** and active filter IC **Q5043-1 (M5218APF)**. The tone generated by this circuit is fed to the frequency modulator via connector J5011.

Electronic Keyer Circuit

The electronic keyer circuit consists mainly of CNTL Unit ICs **Q5035 (MB89133APFM)**, **Q5031 (μ PD4013BG)**, and **Q5040 (24LC02BT)** and **SPEED** control VR9362. When the CW mode is selected, this circuit controls the generation of Morse characters. Paddle input is connected to the keyer IC from key jacks J9442-1 and J5027, and its control signal is fed to **Q5019**, **Q5042**, and **Q5041** (all **2SC4047**) for keying control in the CW mode.

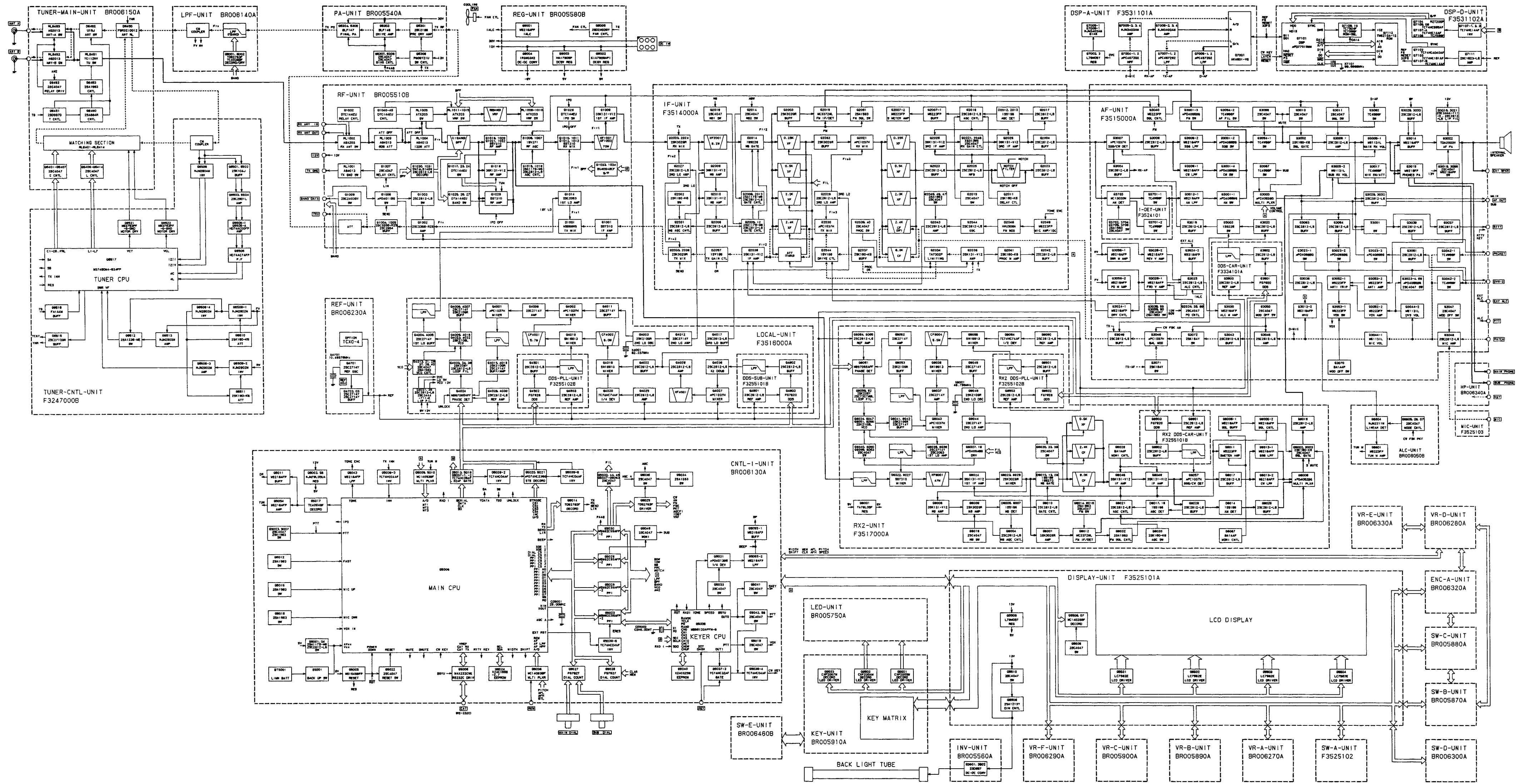

RX LINE ———→
 TX LINE - - - - -
 COMMON LINE ———→

Interconnection Diagram

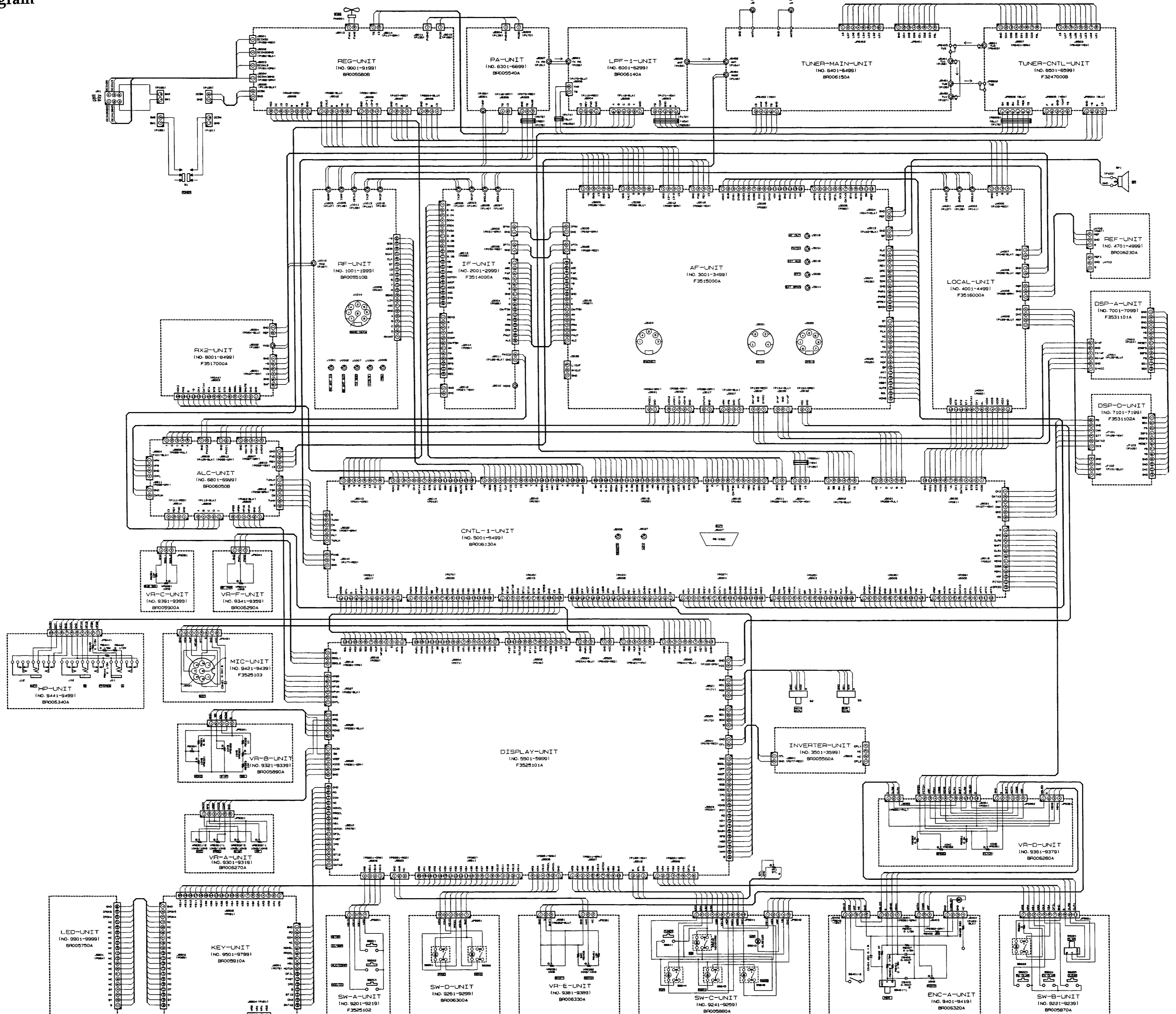

Interconnection Diagram

Parts List

REF.	DESCRIPTION	MFR'S DESIGN	YAESU P/N	Lot.
JP1001	WIREASSY		T9206870	1-
JP2001	WIREASSY		T9206158	1-
JP2003	WIREASSY		T9206159	1-
JP3001	WIREASSY		T9206055	1-
JP3003	WIREASSY		T9206055	1-
JP3004	WIREASSY	BLK 75 <7>/<7>	T54007531	1-
JP3005	WIREASSY	GRN 130 2/2	T50513000	1-
JP5001	WIREASSY	GRN 85 2/2	T50508500	1-
JP5002	WIREASSY	GRN 55 2/2	T50505500	1-
JP5003	WIREASSY	GRN 65 2/2	T50506500	1-
JP5004	WIREASSY	GRN 60 2/2	T50506000	1-
JP5005	WIREASSY	GRN 50 2/2	T50505000	1-
JP5006	WIREASSY	GRN 125 2/2	T50512500	1-
JP6301	JUMPERWIREC	0.6-15.0	Q6100001	1-
JP6401	WIREASSY		T9206154	1-
JP6402	WIREASSY		T9206153	1-
JP6403	WIREASSY	WHT 100 TMP/*	T9318150	1-
JP6453	WIREASSY		T9206879B	1-
JP6453	WIREASSY		T9206879C	19-
JP6454	WIREASSY	RED 110 <5>/<5>	T55211021	1-
JP6454	WIRE-ASSY	VIO100 (3)/(3)	T9318122	9-
JP6501	WIREASSY		T9206156A	1-
JP6502	WIREASSY		T9318153	1-
JP6504	WIREASSY	WHT 230 TMP/*	T9206887	1-
JP6504	WIREASSY		T9206922	12-
JP6505	WIREASSY		T9206890A	1-
JP6506	WIREASSY		T9206878A	1-
JP8902	WIREASSY	GRN 80 2/2	T50508000	1-
JP8903	WIREASSY	GRN 80 2/2	T50508000	1-
JP8904	WIREASSY	GRN 80 2/2	T50508000	1-
JP9201	WIREASSY		T9206474	1-
JP9221	WIRE ASSY		T9206856	1-
JP9221	WIRE ASSY		T9206856A	17-
JP9241	WIREASSY		T9206853	1-
JP9242	WIREASSY		T9206857	1-
JP9261	WIREASSY		T9206479	1-
JP9301	WIRE ASSY		T9206867	1-
JP9301	WIRE ASSY		T9206867A	17-
JP9302	JUMPERWIREA	0.8-5.0	Q6100003	1-
JP9341	WIRE ASSY		T9206478	1-
JP9361	WIRE ASSY		T9206859	1-
JP9362	WIRE ASSY		T9206858	1-
JP9362	WIRE ASSY		T9206858A	17-
JP9363	JUMPERWIREA	0.8-5.0	Q6100003	1-
JP9364	JUMPERWIREA	0.8-5.0	Q6100003	1-
JP9365	JUMPERWIREA	0.8-7.5	Q6100004	1-
JP9381	WIRE ASSY		T9206854	1-
JP9391	WIRE ASSY		T9206487	1-
JP9421	WIRE ASSY		T9206486	1-
JP9441	WIRE ASSY		T9206476A	1-
JP9501	WIRE ASSY	GRN 20 2/2	T50502000	1-
JP9502	WIRE ASSY	GRN 25 2/2	T50502500	1-
JP9503	WIRE ASSY	GRN 30 2/2	T50503000	1-
JP9504	WIRE ASSY	GRN 230 2/2	T50523000	1-
P 0021	WIREASSY		T9206460	1-
P 0025	WIREASSY		T9206496	1-
P 0027	WIREASSY		T9206496	1-
P 0029	WIREASSY		T9206458	1-
P 0031	WIREASSY		T9206459	1-
P 0033	WIREASSY		T9206497	1-
P 0035	WIREASSY		T9206488	1-
P 0037	WIREASSY		T9206457	1-
P 0039	WIREASSY		T9206494	1-
P 0041	WIREASSY		T9206881	1-
P 0043	WIREASSY		T9206491	1-
P 0045	WIREASSY		T9206488	1-
P 0047	WIREASSY		T9206453	1-
P 0049	WIREASSY		T9206492	1-
P 0051	WIREASSY		T9206488	1-
P 0053	WIREASSY		T9206488	1-
P 0055	WIREASSY		T9206490	1-
P 0057	WIREASSY		T9206851	1-
P 0059	WIREASSY		T9206488	1-

REF.	DESCRIPTION	MFR'S DESIGN	YAESU P/N	Lot.
P 0061	WIREASSY		T9206489	1-
P 0065	WIREASSY		T9206452	1-
P 0067	WIREASSY		T9206451	1-
P 0068	WIREASSY		T9206877	1-
P 0071	WIREASSY		T9206496	1-
P 0072	WIREASSY		T9206882A	1-
P 0076	WIREASSY		T9206883	1-
P 0079	WIREASSY		T9206496	1-
P 0081	WIREASSY		T9206495	1-
P 0083	WIREASSY		T9206855	1-
P 0085	WIREASSY		T9206493	1-
P 0087	WIREASSY		T9206498	1-
P 0088	WIREASSY		T9206884	1-
P 0090	WIREASSY		T9206885	1-
P 0093	WIREASSY		T9206860	1-
P 0095	WIREASSY		T9206861	1-
P 0095	WIREASSY		T9206861A	12-
P 0097	WIREASSY		T9206862	1-
P 0099	WIREASSY		T9206863	1-
P 0099	WIREASSY		T9206863A	12-
P 0101	WIREASSY		T9206864	1-
P 0103	WIREASSY		T9206865	1-
P 0105	WIREASSY		T9206492	1-
P 0106	WIREASSY		T9206886	1-
P 0106	WIREASSY		T9206886A	12-
P 0108	WIREASSY		T9206887	1-
P 0108	WIREASSY		T9206887A	12-
P 0110	WIREASSY		T9206888	1-
P 0112	WIREASSY		T9206889A	1-
P 0112	WIREASSY		T9206889B	17-
P 0116	WIREASSY		T9206891	1-
P 0119	WIREASSY		T9206893	1-
P 0121	WIREASSY		T9206443	1-
P 0122	WIREASSY		T9206485	1-
P 0123	WIREASSY		T9206499	1-
P 0125	WIREASSY		T9206866	1-
P 0127	WIREASSY		T9206500A	1-
P 0129	WIREASSY		T9206501A	1-
P 0132	WIREASSY		T9206502	1-
P 0135	WIREASSY	BLK 600 V5.5/V5.5	T9318144	1-
P 0137	WIREASSY	GRN 340 TMP/TMP	T9311406	1-
P 0139	WIREASSY	ORG 210 TMP/TMP	T9317850	1-
P 0141	WIREASSY	BLU 240 TMP/TMP	T9317849	1-
P 0143	WIREASSY	GRA 370 TMP/TMP	T9313201	1-
P 0145	WIREASSY	YEL 300 TMP/TMP	T9311405	1-
P 0147	WIREASSY	GRN 270	T9317896	1-
P 0149	WIREASSY	RED 340 TMP/TMP	T9317854	1-
P 0151	WIREASSY	GRA 130 PINL/PINL	T9318156	1-
P 0153	WIREASSY	YEL 270 PINL/PINL	T9318145	1-
P 0157	WIREASSY	WHT 200 TMP/TMP	T9318152	1-
P 0159	WIREASSY		T9206892	1-
P 0159	WIREASSY		T9206892A	17-
P 0163	WIREASSY		T9206880	1-
P 0165	WIREASSY		T9206443	1-
P 0167	WIREASSY	RED 490 TMP/TMP	T9315907A	1-
P 0169	WIREASSY	RED 600 V5.5/V5.5	T9318143	1-
P 0171	WIREASSY		T9206894	1-
P 0173	WIREASSY		T9206895	1-
P 0175	WIREASSY		T9206900	1-
P 0177	WIREASSY		T9206899	1-
P 0179	WIREASSY		T9206901	1-
P 0181	WIREASSY		T9206912	1-
P 0951	CONNECTOR	S-H3603	P0090008	1-
P 0952	CONNECTOR	MP-105LC	P0090034	1-
P 0953	CONNECTOR	TCP0547-71-5201	P0091004	1-
P 0954	CONNECTOR	TCP1557-71-5201	P0091006	1-
P 0955	CONNECTOR	MP-013LC	P0091046	1-
P 6301	CONNECTOR	IMSA-9206H-T	P1090988	1-
P 8701	WIREASSY		T9206911	1-

Interconnection Diagram

Notes

RF-UNIT BRO05510B

ME-A, ME-B, ME-C, ME-D, RA0, RA1, RA2, RA3

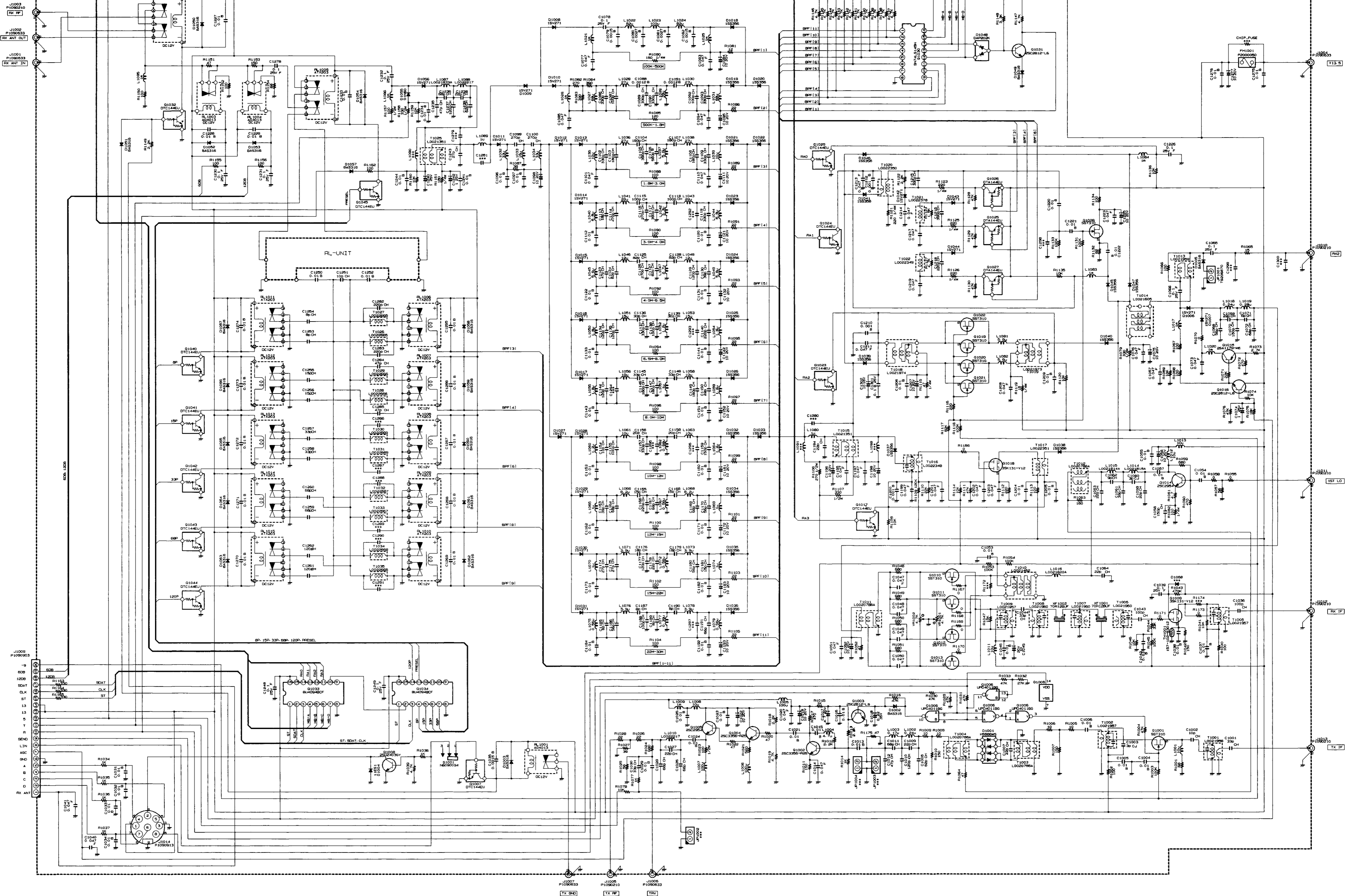

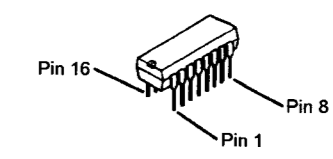

SN74LS145N
(Q1030)

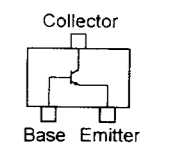

2SC2812 (L6)
(Q1003, 1016, 1031)

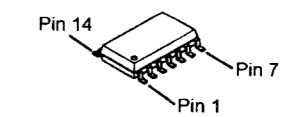

μPD4011BG-T2
(Q1006)

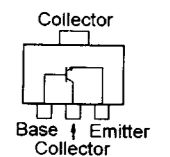

2SC2954 (QK)
(Q1005, Q1014)
2SD2403GY-T1 (GY)
(Q1008)

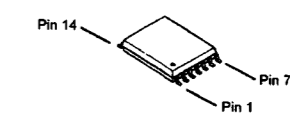

BU4094BCF-E2
(Q1033, 1034)

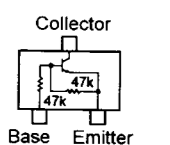

DTC144EU (26)
(Q1040, 1041,
1042, 1043, 1044)

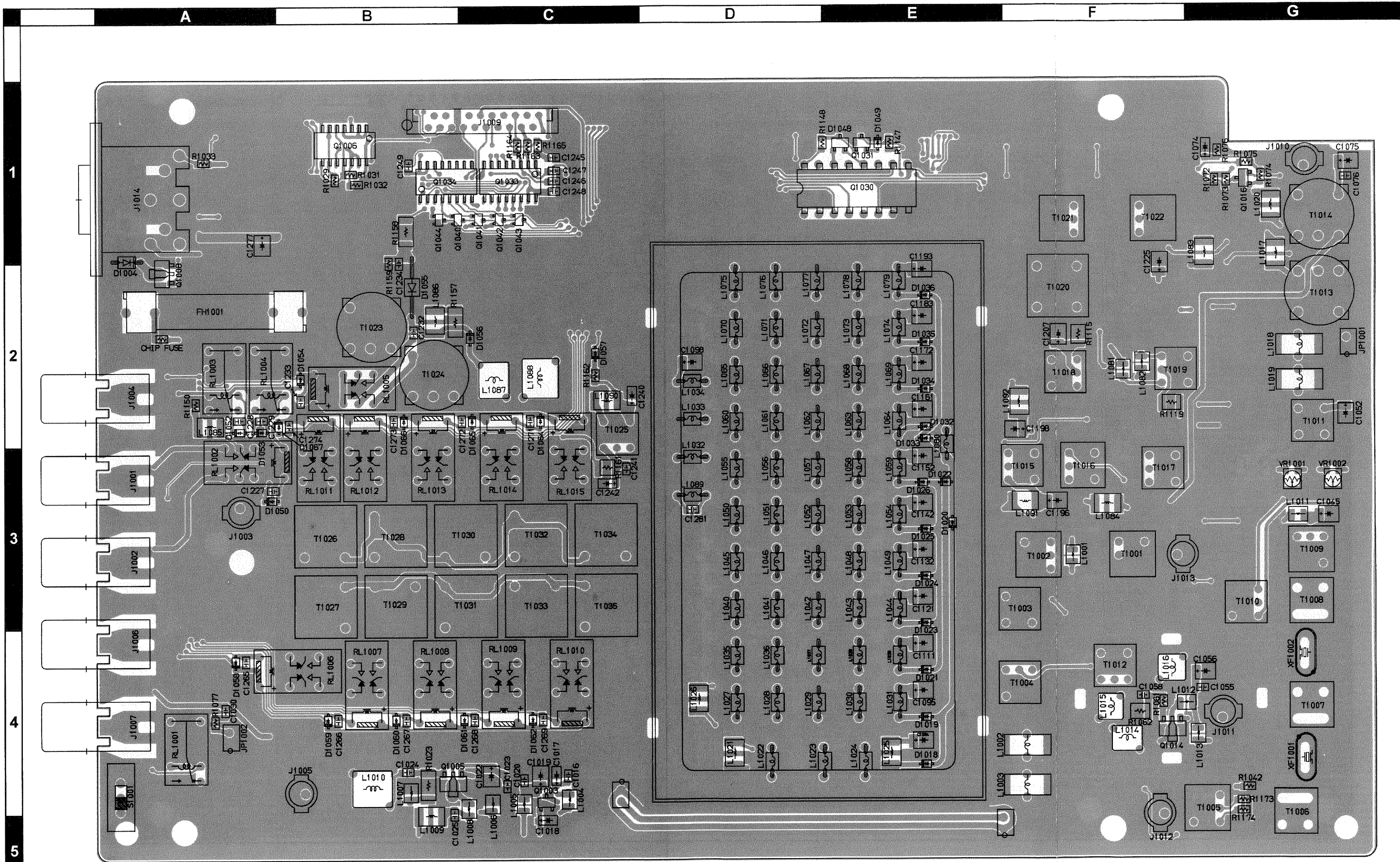

Side A

RF Unit (Lot. 1~)

Parts Layout

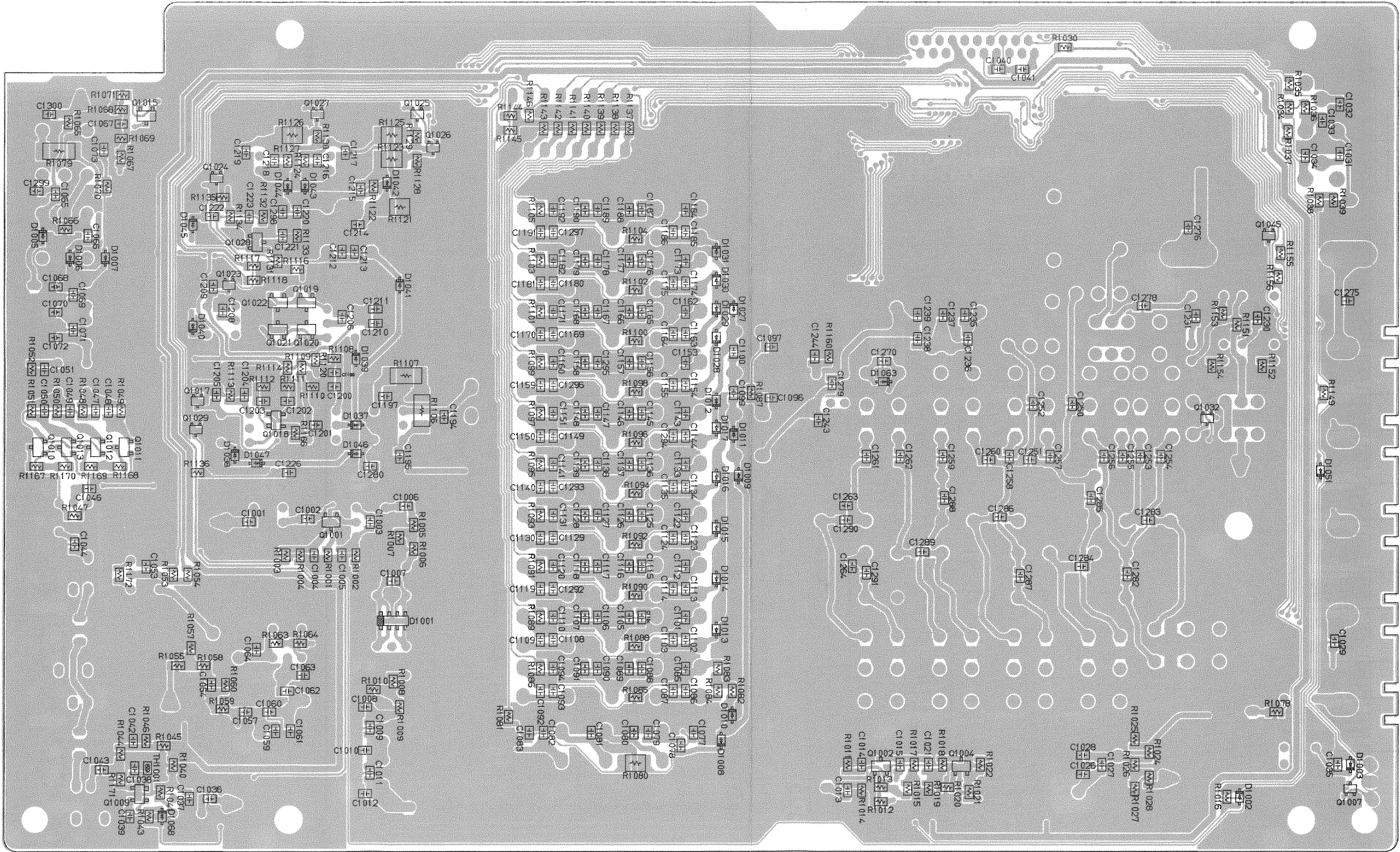

Side B

RF-UNIT BR005510C

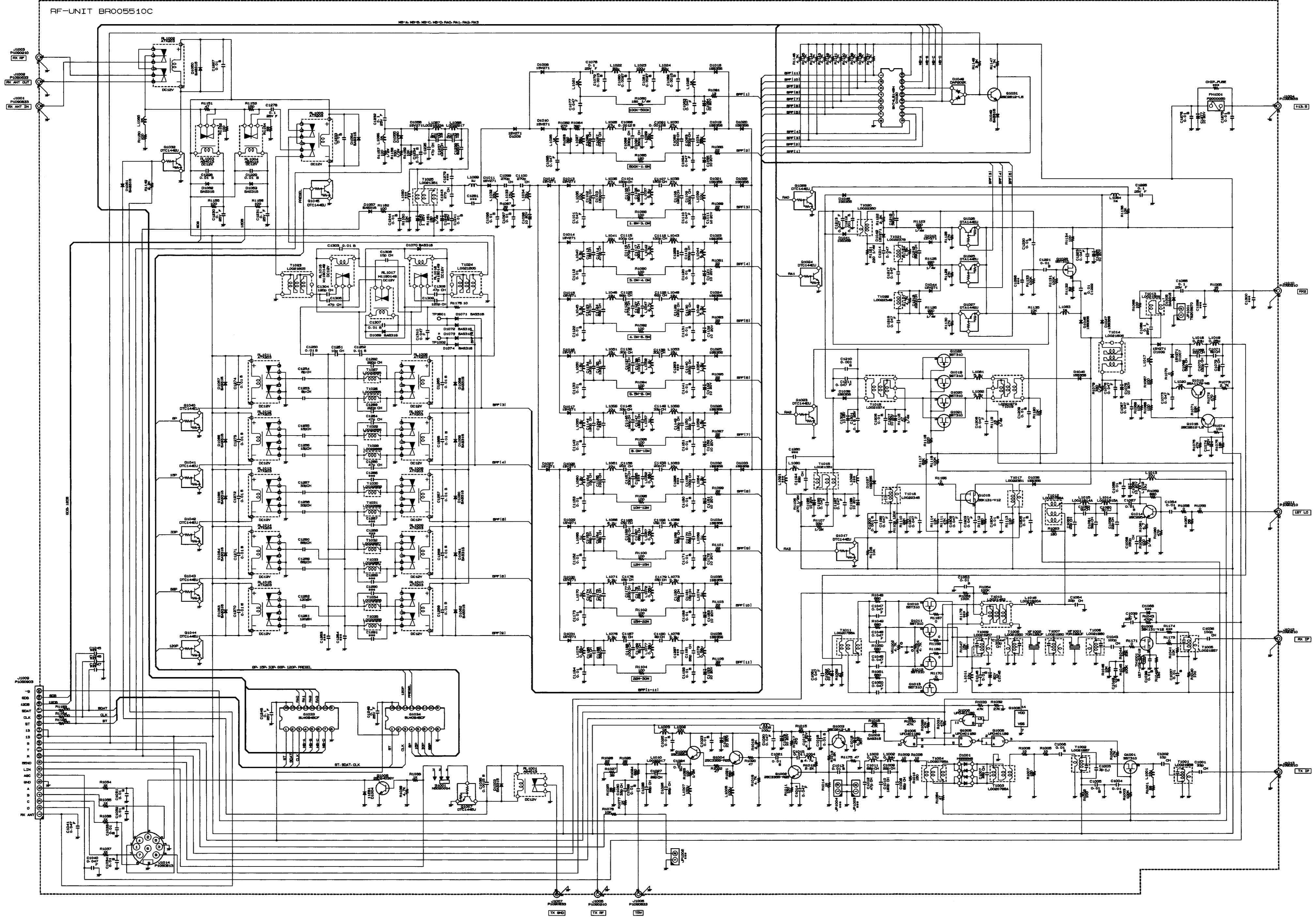

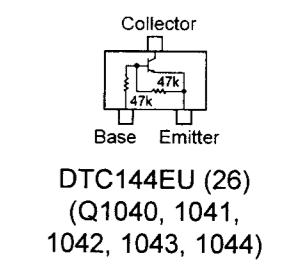
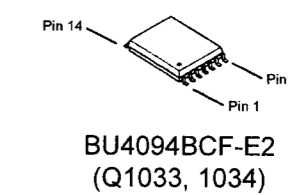
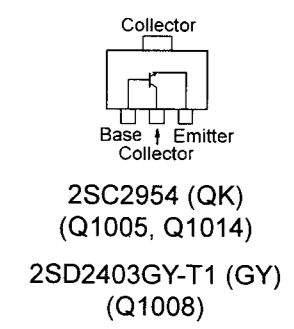
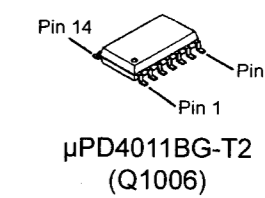
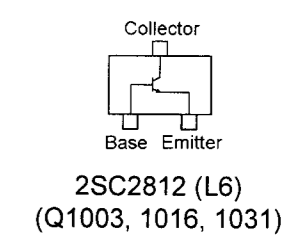
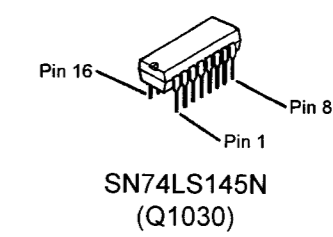

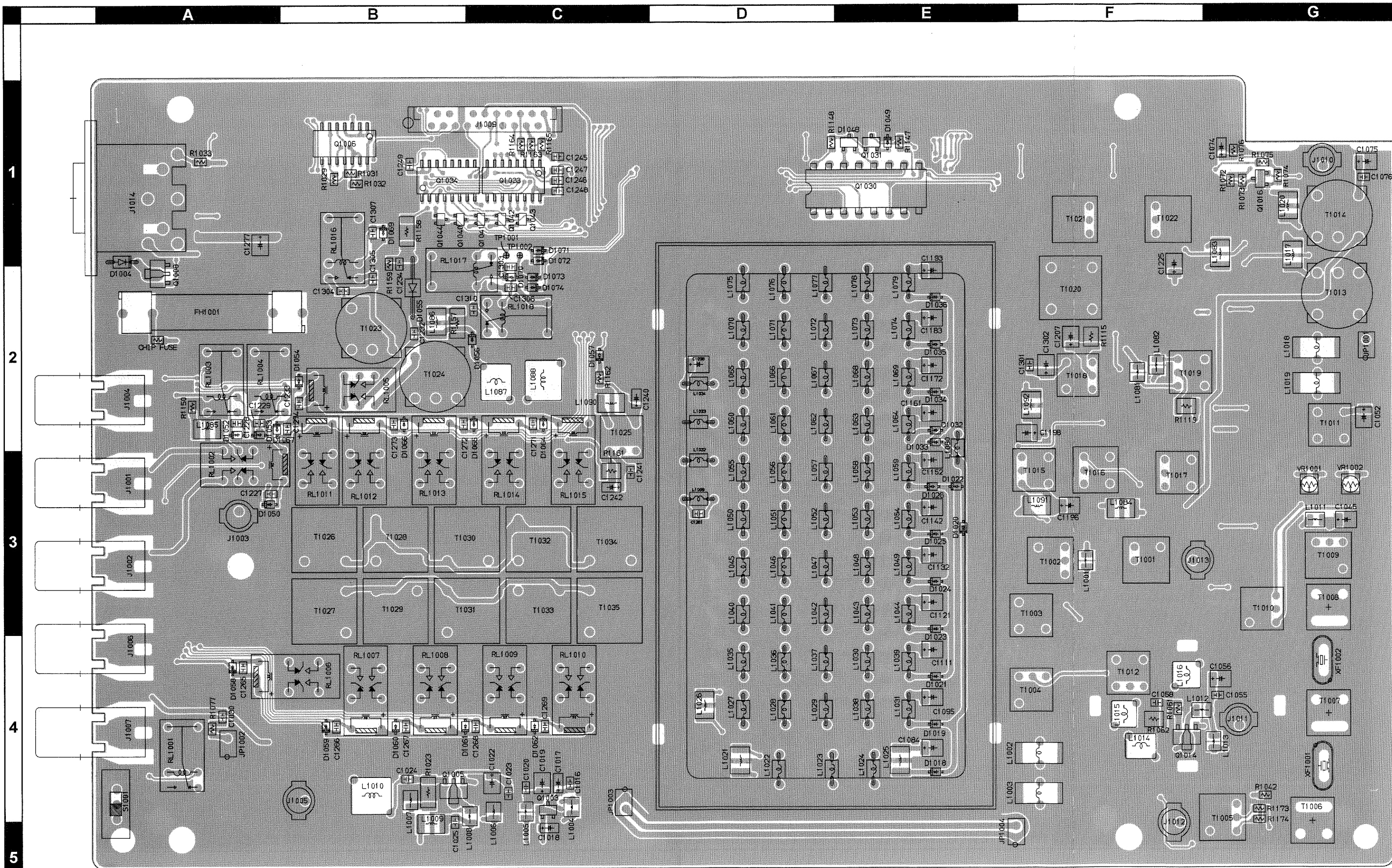

Side A

RF Unit (Lot. 9~)

Parts Layout

a b c d e f g h

1
2
3
4
5

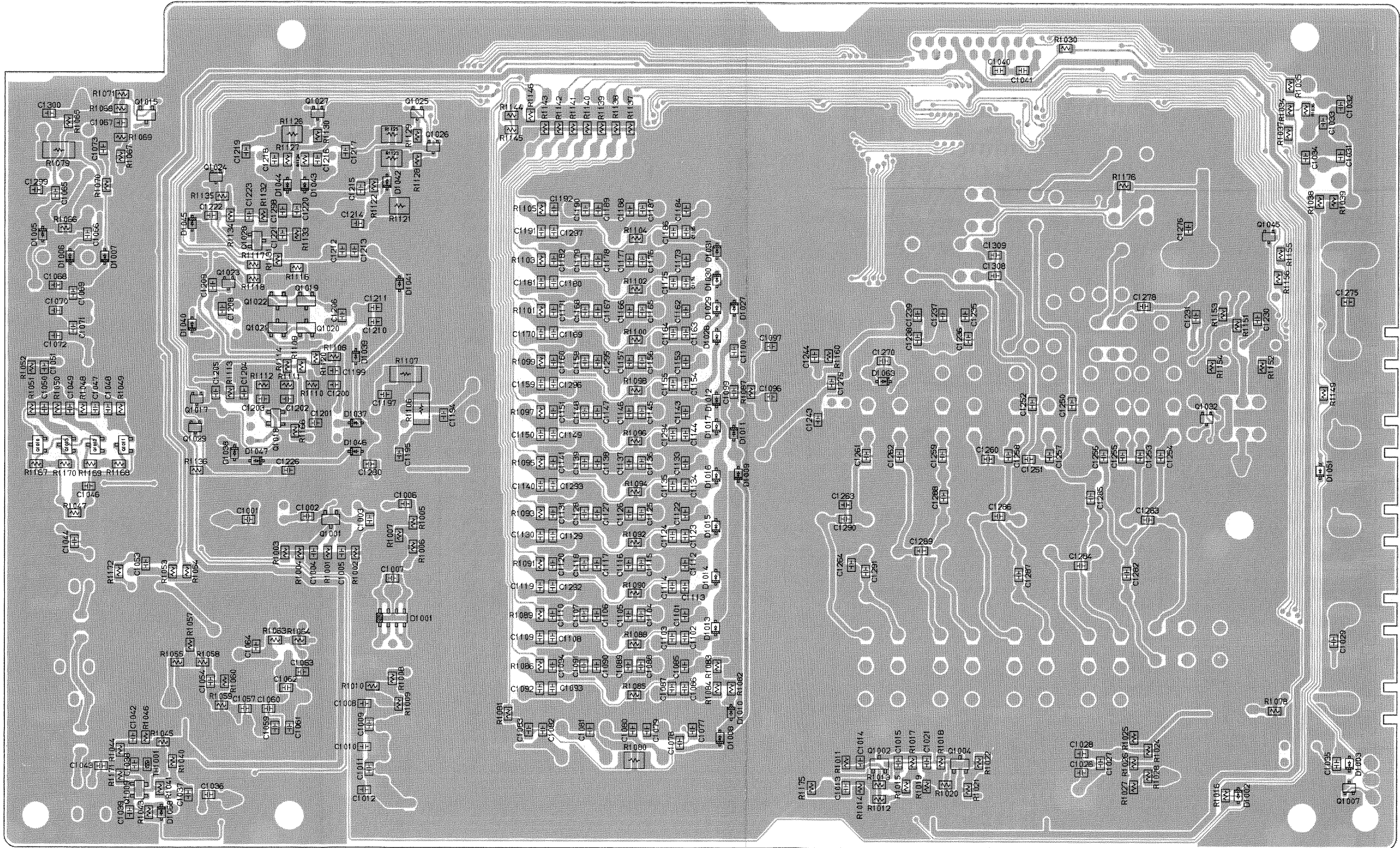

Side B

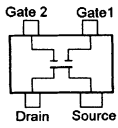

3SK131 (V12)
(Q1009, 1018)

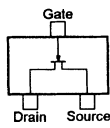

SST310-T1 (ZO)
(Q1001, 1010,
1011, 1012, 1013,
1019, 1020, 1021,
1022, 1028)

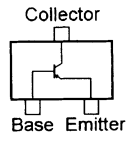

2SA1179M6 (M6)
(Q1015)
2SC3356 (R25)
(Q1002, 1004)

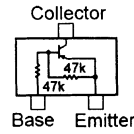

DTA144EU (16)
(Q1025, 1026,
1027, 1007, 1017,
1023, 1024, 1029,
1032)

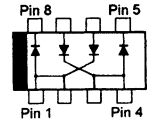

HSB88WSTR
(D1001)

RF Unit

Parts List

REF.	DESCRIPTION	VALUE	V/W	TOL.	MFR'S DESIG	YAESU P/N	VERS.	LOT.	LAY ADR
	PCB with Components					CB1180001	W/O CE LABEL		
	PCB with Components					CB1180002	W/ CE LABEL		
	Printed Circuit Board					FR005510B		1-	
	Printed Circuit Board					FR005510C		9-	
C 1001	CHIP CAP.	33pF	50V	CH	GRM40CH330J50PT	K22170223		1-	
C 1002	CHIP CAP.	10pF	50V	CH	GRM40CH100D50PT	K22170211		1-	
C 1003	CHIP CAP.	3pF	50V	CJ	GRM40CJ030C50PT	K22170204		1-	
C 1004	CHIP CAP.	0.01uF	50V	B	GRM40B103M50PT	K22170817		1-	
C 1005	CHIP CAP.	0.01uF	50V	B	GRM40B103M50PT	K22170817		1-	
C 1006	CHIP CAP.	0.01uF	50V	B	GRM40B103M50PT	K22170817		1-	
C 1007	CHIP CAP.	22pF	50V	CH	GRM40CH220J50PT	K22170219		1-	
C 1008	CHIP CAP.	82pF	50V	CH	GRM40CH820J50PT	K22170233		1-	
C 1009	CHIP CAP.	22pF	50V	CH	GRM40CH220J50PT	K22170219		1-	
C 1010	CHIP CAP.	120pF	50V	CH	GRM40CH121J50PT	K22170237		1-	
C 1011	CHIP CAP.	68pF	50V	CH	GRM40CH680J50PT	K22170231		1-	
C 1012	CHIP CAP.	47pF	50V	CH	GRM40CH470J50PT	K22170227		1-	
C 1013	CHIP CAP.	0.01uF	50V	B	GRM40B103M50PT	K22170817		1-	
C 1014	CHIP CAP.	0.047uF	50V	F	GRM40F473Z50PT	K22171008		1-	
C 1015	CHIP CAP.	0.01uF	50V	B	GRM40B103M50PT	K22170817		1-	
C 1016	CHIP CAP.	0.01uF	50V	B	GRM40B103M50PT	K22170817		1-	
C 1017	CHIP TA.CAP.	4.7uF	20V		TEMSVA1D475M-8R	K78130048		1-	
C 1018	CHIP TA.CAP.	0.22uF	35V		TESVA1V224M1-8R	K78160027		1-	
C 1019	CHIP TA.CAP.	10uF	20V		TEMSVB21D106M-8R	K78130028		1-	
C 1020	CHIP CAP.	0.047uF	50V	F	GRM40F473Z50PT	K22171008		1-	
C 1021	CHIP CAP.	0.01uF	50V	B	GRM40B103M50PT	K22170817		1-	
C 1022	CHIP TA.CAP.	10uF	20V		TEMSVB21D106M-8R	K78130028		1-	
C 1023	CHIP CAP.	0.01uF	50V	B	GRM40B103M50PT	K22170817		1-	
C 1024	CHIP CAP.	0.01uF	50V	B	GRM40B103M50PT	K22170817		1-	
C 1025	CHIP CAP.	0.01uF	50V	B	GRM40B103M50PT	K22170817		1-	
C 1026	CHIP CAP.	68pF	50V	CH	GRM40CH680J50PT	K22170231		1-	
C 1027	CHIP CAP.	22pF	50V	CH	GRM40CH220J50PT	K22170219		1-	
C 1028	CHIP CAP.	68pF	50V	CH	GRM40CH680J50PT	K22170231		1-	
C 1029	CHIP CAP.	0.01uF	50V	B	GRM40B103M50PT	K22170817		1-	
C 1030	CHIP CAP.	33pF	50V	CH	GRM40CH330J50PT	K22170223		1-	
C 1030	CHIP CAP.	0.1uF	25V	B	GRM40B104M25PT	K22140811		6-	
C 1031	CHIP CAP.	0.01uF	50V	B	GRM40B103M50PT	K22170817		1-	
C 1031	CHIP CAP.	0.01uF	50V	B	GRM40B103M50PT	K22170817		6-	
C 1032	CHIP CAP.	0.01uF	50V	B	GRM40B103M50PT	K22170817		1-	
C 1033	CHIP CAP.	0.01uF	50V	B	GRM40B103M50PT	K22170817		1-	
C 1034	CHIP CAP.	0.01uF	50V	B	GRM40B103M50PT	K22170817		1-	
C 1035	CHIP CAP.	0.0015uF	50V	B	GRM40B152M50PT	K22170807		1-	
C 1036	CHIP CAP.	100pF	50V	CH	GRM40CH101J50PT	K22170235		1-	
C 1037	CHIP CAP.	0.01uF	50V	B	GRM40B103M50PT	K22170817		1-	
C 1038	CHIP CAP.	0.01uF	50V	B	GRM40B103M50PT	K22170817		1-	
C 1039	CHIP CAP.	0.1uF	25V	F	GRM40F104Z25PT	K22141005		1-	
C 1040	CHIP CAP.	0.047uF	50V	F	GRM40F473Z50PT	K22171008		1-	
C 1041	CHIP CAP.	0.047uF	50V	F	GRM40F473Z50PT	K22171008		1-	
C 1042	CHIP CAP.	0.01uF	50V	B	GRM40B103M50PT	K22170817		1-	
C 1043	CHIP CAP.	100pF	50V	CH	GRM40CH101J50PT	K22170235		1-	
C 1044	CHIP CAP.	33pF	50V	CH	GRM40CH330J50PT	K22170223		1-	
C 1045	CHIP TA.CAP.	10uF	20V		TEMSVB21D106M-8R	K78130028		1-	
C 1046	CHIP CAP.	0.01uF	50V	B	GRM40B103M50PT	K22170817		1-	
C 1047	CHIP CAP.	0.047uF	50V	F	GRM40F473Z50PT	K22171008		1-	
C 1048	CHIP CAP.	0.047uF	50V	F	GRM40F473Z50PT	K22171008		1-	
C 1049	CHIP CAP.	0.047uF	50V	F	GRM40F473Z50PT	K22171008		1-	
C 1050	CHIP CAP.	0.047uF	50V	F	GRM40F473Z50PT	K22171008		1-	
C 1051	CHIP CAP.	0.047uF	50V	F	GRM40F473Z50PT	K22171008		1-	
C 1052	CHIP TA.CAP.	10uF	20V		TEMSVB21D106M-8R	K78130028		1-	
C 1053	CHIP CAP.	0.01uF	50V	B	GRM40B103M50PT	K22170817		1-	
C 1054	CHIP CAP.	0.01uF	50V	B	GRM40B103M50PT	K22170817		1-	
C 1055	CHIP CAP.	0.01uF	50V	B	GRM40B103M50PT	K22170817		1-	
C 1056	CHIP TA.CAP.	10uF	20V		TEMSVB21D106M-8R	K78130028		1-	
C 1057	CHIP CAP.	0.01uF	50V	B	GRM40B103M50PT	K22170817		1-	
C 1058	CHIP CAP.	150pF	50V	CH	GRM40CH151J50PT	K22170239		1-	
C 1059	CHIP CAP.	22pF	50V	CH	GRM40CH220J50PT	K22170219		1-	
C 1060	CHIP CAP.	3pF	50V	CJ	GRM40CJ030C50PT	K22170204		1-	
C 1061	CHIP CAP.	39pF	50V	CH	GRM40CH390J50PT	K22170225		1-	
C 1062	CHIP CAP.	9pF	50V	CH	GRM40CH090D50PT	K22170210		1-	

REF.	DESCRIPTION	VALUE	V/W	TOL.	MFR'S DESIG	YAESU P/N	VERS.	LOT.	LAY ADR
C 1063	CHIP CAP.	22pF	50V	CH	GRM40CH220J50PT	K22170219		1-	
C 1064	CHIP CAP.	22pF	50V	CH	GRM40CH220J50PT	K22170219		1-	
C 1065	CHIP CAP.	0.1uF	25V	F	GRM40F104Z25PT	K22141005		1-	
C 1066	CHIP CAP.	0.1uF	25V	F	GRM40F104Z25PT	K22141005		1-	
C 1067	CHIP CAP.	0.047uF	50V	F	GRM40F473Z50PT	K22171008		1-	
C 1068	CHIP CAP.	56pF	50V	CH	GRM40CH560J50PT	K22170229		1-	
C 1069	CHIP CAP.	22pF	50V	CH	GRM40CH220J50PT	K22170219		1-	
C 1070	CHIP CAP.	150pF	50V	CH	GRM40CH151J50PT	K22170239		1-	
C 1071	CHIP CAP.	6pF	50V	CH	GRM40CH060D50PT	K22170207		1-	
C 1072	CHIP CAP.	68pF	50V	CH	GRM40CH680J50PT	K22170231		1-	
C 1073	CHIP CAP.	0.047uF	50V	F	GRM40F473Z50PT	K22171008		1-	
C 1074	CHIP TA.CAP.	1uF	25V		TEMSVA1E105M-8R	K78140013		1-	
C 1075	CHIP TA.CAP.	10uF	20V		TEMSVB21D106M-8R	K78130028		1-	
C 1076	CHIP CAP.	0.047uF	50V	F	GRM40F473Z50PT	K22171008		1-	
C 1077	CHIP CAP.	0.047uF	50V	F	GRM40F473Z50PT	K22171008		1-	
C 1078	CHIP CAP.	0.1uF	25V	F	GRM40F104Z25PT	K22141005		1-	
C 1079	CHIP CAP.	0.0015uF	50V	B	GRM40B152M50PT	K22170807		1-	
C 1080	CHIP CAP.	0.0027uF	50V	B	GRM40B272M50PT	K22170810		1-	
C 1081	CHIP CAP.	0.0027uF	50V	B	GRM40B272M50PT	K22170810		1-	
C 1082	CHIP CAP.	0.0015uF	50V	B	GRM40B152M50PT	K22170807		1-	
C 1083	CHIP CAP.	0.047uF	50V	F	GRM40F473Z50PT	K22171008		1-	
C 1084	CHIP TA.CAP.	10uF	20V		TEMSVB21D106M-8R	K78130028		1-	
C 1085	CHIP CAP.	0.047uF	50V	F	GRM40F473Z50PT	K22171008		1-	
C 1086	CHIP CAP.	330pF	50V	CH	GRM40CH331J50PT	K22170247		1-	
C 1087	CHIP CAP.	100pF	50V	CH	GRM40CH101J50PT	K22170235		1-	
C 1088	CHIP CAP.	0.0012uF	50V	B	GRM40B122M50PT	K22170806		1-	
C 1089	CHIP CAP.	330pF	50V	CH	GRM40CH331J50PT	K22170247		1-	
C 1090	CHIP CAP.	330pF	50V	CH	GRM40CH331J50PT	K22170247		1-	
C 1091	CHIP CAP.	0.0012uF	50V	B	GRM40B122M50PT	K22170806		1-	
C 1092	CHIP CAP.	100pF	50V	CH	GRM40CH101J50PT	K22170235		1-	
C 1093	CHIP CAP.	330pF	50V	CH	GRM40CH331J50PT	K22170247		1-	
C 1094	CHIP CAP.	0.047uF	50V	F	GRM40F473Z50PT	K22171008		1-	
C 1095	CHIP TA.CAP.	10uF	20V		TEMSVB21D106M-8R	K78130028		1-	
C 1096	CHIP CAP.	0.01uF	50V	B	GRM40B103M50PT	K22170817		1-	
C 1097	CHIP CAP.	0.01uF	50V	B	GRM40B103M50PT	K22170817		1-	
C 1098	CHIP TA.CAP.	10uF	20V		TEMSVB21D106M-8R	K78130028		1-	
C 1099	CHIP CAP.	270pF	50V	CH	GRM40CH271J50PT	K22170245		1-	
C 1100	CHIP CAP.	270pF	50V	CH	GRM40CH271J50PT	K22170245		1-	
C 1101	CHIP CAP.	0.047uF	50V	F	GRM40F473Z50PT	K22171008		1-	
C 1102	CHIP CAP.	330pF	50V	CH	GRM40CH331J50PT	K22170247		1-	
C 1103	CHIP CAP.	180pF	50V	CH	GRM40CH181J50PT	K22170241		1-	
C 1104	CHIP CAP.	180pF	50V	CH	GRM40CH181J50PT	K22170241		1-	
C 1105	CHIP CAP.	390pF	50V	CH	GRM40CH391J50PT	K22170249		1-	
C 1106	CHIP CAP.	560pF	50V	B	GRM40B561M50PT	K22170802		1-	
C 1107	CHIP CAP.	180pF	50V	CH	GRM40CH181J50PT	K22170241		1-	
C 1108	CHIP CAP.	180pF	50V	CH	GRM40CH181J50PT	K22170241		1-	
C 1109	CHIP CAP.	330pF	50V	CH	GRM40CH331J50PT	K22170247		1-	
C 1110	CHIP CAP.	0.047uF	50V	F	GRM40F473Z50PT	K22171008		1-	
C 1111	CHIP TA.CAP.	10uF	20V		TEMSVB21D106M-8R	K78130028		1-	
C 1112	CHIP CAP.	0.01uF	50V	B	GRM40B103M50PT	K22170817		1-	
C 1113	CHIP CAP.	18pF	50V	CH	GRM40CH180J50PT	K22170217		1-	
C 1114	CHIP CAP.	470pF	50V	CH	GRM40CH471J50PT	K22170251		1-	
C 1115	CHIP CAP.	100pF	50V	CH	GRM40CH101J50PT	K22170235		1-	
C 1116	CHIP CAP.	270pF	50V	CH	GRM40CH271J50PT	K22170245		1-	
C 1117	CHIP CAP.	390pF	50V	CH	GRM40CH391J50PT	K22170249		1-	
C 1118	CHIP CAP.	100pF	50V	CH	GRM40CH101J50PT	K22170235		1-	
C 1119	CHIP CAP.	330pF	50V	CH	GRM40CH331J50PT	K22170247		1-	
C 1120	CHIP CAP.	0.01uF	50V	B	GRM40B103M50PT	K22170817		1-	
C 1121	CHIP TA.CAP.	10uF	20V		TEMSVB21D106M-8R	K78130028		1-	
C 1122	CHIP CAP.	0.01uF	50V	B	GRM40B103M50PT	K22170817		1-	
C 1123	CHIP CAP.	47pF	50V	CH	GRM40CH470J50PT	K22170227		1-	
C 1124	CHIP CAP.	82pF	50V	CH	GRM40CH820J50PT	K22170233		1-	
C 1125	CHIP CAP.	82pF	50V	CH	GRM40CH820J50PT	K22170233		1-	
C 1126	CHIP CAP.	270pF	50V	CH	GRM40CH271J50PT	K22170245		1-	
C 1127	CHIP CAP.	82pF	50V	CH	GRM40CH820J50PT	K22170233		1-	
C 1128	CHIP CAP.	82pF	50V	CH	GRM40CH820J50PT	K22170233		1-	
C 1129	CHIP CAP.	120pF	50V	CH	GRM40CH121J50PT	K22170237		1-	
C 1130	CHIP CAP.	39pF	50V	CH	GRM40CH390J50PT	K22170225		1-	

RF Unit

Parts List

REF.	DESCRIPTION	VALUE	V/W	TOL.	MFR'S DESIG	YAESU P/N	VERS.	LOT.	LAY ADR
C 1131	CHIP CAP.	0.01uF	50V	B	GRM40B103M50PT	K22170817		1-	
C 1132	CHIP TA.CAP.	10uF	20V		TEMSVB21D106M-8R	K78130028		1-	
C 1133	CHIP CAP.	0.01uF	50V	B	GRM40B103M50PT	K22170817		1-	
C 1134	CHIP CAP.	120pF	50V	CH	GRM40CH121J50PT	K22170237		1-	
C 1135	CHIP CAP.	120pF	50V	CH	GRM40CH121J50PT	K22170237		1-	
C 1136	CHIP CAP.	30pF	50V	CH	GRM40CH300J50PT	K22170222		1-	
C 1137	CHIP CAP.	330pF	50V	CH	GRM40CH331J50PT	K22170247		1-	
C 1138	CHIP CAP.	100pF	50V	CH	GRM40CH101J50PT	K22170235		1-	
C 1139	CHIP CAP.	30pF	50V	CH	GRM40CH300J50PT	K22170222		1-	
C 1140	CHIP CAP.	220pF	50V	CH	GRM40CH221J50PT	K22170243		1-	
C 1141	CHIP CAP.	0.01uF	50V	B	GRM40B103M50PT	K22170817		1-	
C 1142	CHIP TA.CAP.	10uF	20V		TEMSVB21D106M-8R	K78130028		1-	
C 1143	CHIP CAP.	0.01uF	50V	B	GRM40B103M50PT	K22170817		1-	
C 1144	CHIP CAP.	120pF	50V	CH	GRM40CH121J50PT	K22170237		1-	
C 1145	CHIP CAP.	33pF	50V	CH	GRM40CH330J50PT	K22170223		1-	
C 1146	CHIP CAP.	180pF	50V	CH	GRM40CH181J50PT	K22170241		1-	
C 1147	CHIP CAP.	180pF	50V	CH	GRM40CH181J50PT	K22170241		1-	
C 1148	CHIP CAP.	33pF	50V	CH	GRM40CH330J50PT	K22170223		1-	
C 1149	CHIP CAP.	180pF	50V	CH	GRM40CH181J50PT	K22170241		1-	
C 1150	CHIP CAP.	22pF	50V	CH	GRM40CH220J50PT	K22170219		1-	
C 1151	CHIP CAP.	0.01uF	50V	B	GRM40B103M50PT	K22170817		1-	
C 1152	CHIP TA.CAP.	10uF	20V		TEMSVB21D106M-8R	K78130028		1-	
C 1153	CHIP CAP.	0.01uF	50V	B	GRM40B103M50PT	K22170817		1-	
C 1154	CHIP CAP.	10pF	50V	CH	GRM40CH100D50PT	K22170211		1-	
C 1155	CHIP CAP.	100pF	50V	CH	GRM40CH101J50PT	K22170235		1-	
C 1156	CHIP CAP.	20pF	50V	CH	GRM40CH200J50PT	K22170218		1-	
C 1157	CHIP CAP.	330pF	50V	CH	GRM40CH331J50PT	K22170247		1-	
C 1158	CHIP CAP.	20pF	50V	CH	GRM40CH200J50PT	K22170218		1-	
C 1159	CHIP CAP.	150pF	50V	CH	GRM40CH151J50PT	K22170239		1-	
C 1160	CHIP CAP.	0.01uF	50V	B	GRM40B103M50PT	K22170817		1-	
C 1161	CHIP TA.CAP.	10uF	20V		TEMSVB21D106M-8R	K78130028		1-	
C 1162	CHIP CAP.	0.01uF	50V	B	GRM40B103M50PT	K22170817		1-	
C 1163	CHIP CAP.	39pF	50V	CH	GRM40CH390J50PT	K22170225		1-	
C 1164	CHIP CAP.	68pF	50V	CH	GRM40CH680J50PT	K22170231		1-	
C 1165	CHIP CAP.	15pF	50V	CH	GRM40CH150J50PT	K22170215		1-	
C 1166	CHIP CAP.	220pF	50V	CH	GRM40CH221J50PT	K22170243		1-	
C 1167	CHIP CAP.	68pF	50V	CH	GRM40CH680J50PT	K22170231		1-	
C 1168	CHIP CAP.	15pF	50V	CH	GRM40CH150J50PT	K22170215		1-	
C 1169	CHIP CAP.	68pF	50V	CH	GRM40CH680J50PT	K22170231		1-	
C 1170	CHIP CAP.	56pF	50V	CH	GRM40CH560J50PT	K22170229		1-	
C 1171	CHIP CAP.	0.01uF	50V	B	GRM40B103M50PT	K22170817		1-	
C 1172	CHIP TA.CAP.	10uF	20V		TEMSVB21D106M-8R	K78130028		1-	
C 1173	CHIP CAP.	0.01uF	50V	B	GRM40B103M50PT	K22170817		1-	
C 1174	CHIP CAP.	27pF	50V	CH	GRM40CH270J50PT	K22170221		1-	
C 1175	CHIP CAP.	27pF	50V	CH	GRM40CH270J50PT	K22170221		1-	
C 1176	CHIP CAP.	18pF	50V	CH	GRM40CH180J50PT	K22170217		1-	
C 1177	CHIP CAP.	120pF	50V	CH	GRM40CH121J50PT	K22170237		1-	
C 1178	CHIP CAP.	22pF	50V	CH	GRM40CH220J50PT	K22170219		1-	
C 1179	CHIP CAP.	18pF	50V	CH	GRM40CH180J50PT	K22170217		1-	
C 1180	CHIP CAP.	56pF	50V	CH	GRM40CH560J50PT	K22170229		1-	
C 1181	CHIP CAP.	15pF	50V	CH	GRM40CH150J50PT	K22170215		1-	
C 1182	CHIP CAP.	0.01uF	50V	B	GRM40B103M50PT	K22170817		1-	
C 1183	CHIP TA.CAP.	10uF	20V		TEMSVB21D106M-8R	K78130028		1-	
C 1184	CHIP CAP.	0.01uF	50V	B	GRM40B103M50PT	K22170817		1-	
C 1185	CHIP CAP.	8pF	50V	CH	GRM40CH080D50PT	K22170209		1-	
C 1186	CHIP CAP.	56pF	50V	CH	GRM40CH560J50PT	K22170229		1-	
C 1187	CHIP CAP.	8pF	50V	CH	GRM40CH080D50PT	K22170209		1-	
C 1188	CHIP CAP.	100pF	50V	CH	GRM40CH101J50PT	K22170235		1-	
C 1189	CHIP CAP.	8pF	50V	CH	GRM40CH080D50PT	K22170209		1-	
C 1190	CHIP CAP.	8pF	50V	CH	GRM40CH080D50PT	K22170209		1-	
C 1191	CHIP CAP.	68pF	50V	CH	GRM40CH680J50PT	K22170231		1-	
C 1192	CHIP CAP.	0.01uF	50V	B	GRM40B103M50PT	K22170817		1-	
C 1193	CHIP TA.CAP.	10uF	20V		TEMSVB21D106M-8R	K78130028		1-	
C 1194	CHIP CAP.	22pF	50V	CH	GRM40CH220J50PT	K22170219		1-	
C 1195	CHIP CAP.	0.047uF	50V	F	GRM40F473Z50PT	K22171008		1-	
C 1196	CHIP TA.CAP.	10uF	20V		TEMSVB21D106M-8R	K78130028		1-	
C 1197	CHIP CAP.	0.047uF	50V	F	GRM40F473Z50PT	K22171008		1-	
C 1198	CHIP TA.CAP.	10uF	20V		TEMSVB21D106M-8R	K78130028		1-	

REF.	DESCRIPTION	VALUE	V/W	TOL.	MFR'S DESIG	YAESU P/N	VERS.	LOT.	LAY ADR
C 1199	CHIP CAP.	0.047uF	50V	F	GRM40F473Z50PT	K22171008		1-	
C 1200	CHIP CAP.	0.001uF	50V	B	GRM40B102M50PT	K22170805		1-	
C 1201	CHIP CAP.	0.047uF	50V	F	GRM40F473Z50PT	K22171008		1-	
C 1202	CHIP CAP.	0.047uF	50V	F	GRM40F473Z50PT	K22171008		1-	
C 1203	CHIP CAP.	0.047uF	50V	F	GRM40F473Z50PT	K22171008		1-	
C 1204	CHIP CAP.	0.01uF	50V	B	GRM40B103M50PT	K22170817		1-	
C 1205	CHIP CAP.	0.01uF	50V	B	GRM40B103M50PT	K22170817		1-	
C 1206	CHIP CAP.	0.01uF	50V	B	GRM40B103M50PT	K22170817		1-	
C 1207	CHIP TA.CAP.	10uF	20V		TEMSVB21D106M-8R	K78130028		1-	
C 1208	CHIP CAP.	0.047uF	50V	F	GRM40F473Z50PT	K22171008		1-	
C 1209	CHIP CAP.	0.01uF	50V	B	GRM40B103M50PT	K22170817		1-	
C 1210	CHIP CAP.	0.001uF	50V	B	GRM40B102M50PT	K22170805		1-	
C 1211	CHIP CAP.	0.047uF	50V	F	GRM40F473Z50PT	K22171008		1-	
C 1212	CHIP CAP.	0.001uF	50V	B	GRM40B102M50PT	K22170805		1-	
C 1213	CHIP CAP.	0.047uF	50V	F	GRM40F473Z50PT	K22171008		1-	
C 1214	CHIP CAP.	0.047uF	50V	F	GRM40F473Z50PT	K22171008		1-	
C 1215	CHIP CAP.	390pF	50V	CH	GRM40CH391J50PT	K22170249		1-	
C 1216	CHIP CAP.	390pF	50V	CH	GRM40CH391J50PT	K22170249		1-	
C 1217	CHIP CAP.	0.047uF	50V	F	GRM40F473Z50PT	K22171008		1-	
C 1218	CHIP CAP.	220pF	50V	CH	GRM40CH221J50PT	K22170243		1-	
C 1219	CHIP CAP.	0.047uF	50V	F	GRM40F473Z50PT	K22171008		1-	
C 1220	CHIP CAP.	0.01uF	50V	B	GRM40B103M50PT	K22170817		1-	
C 1221	CHIP CAP.	0.01uF	50V	B	GRM40B103M50PT	K22170817		1-	
C 1222	CHIP CAP.	0.01uF	50V	B	GRM40B103M50PT	K22170817		1-	
C 1223	CHIP CAP.	0.047uF	50V	F	GRM40F473Z50PT	K22171008		1-	
C 1225	CHIP TA.CAP.	10uF	20V		TEMSVB21D106M-8R	K78130028		1-	
C 1226	CHIP CAP.	0.1uF	25V	F	GRM40F104Z25PT	K22141005		1-	
C 1227	CHIP CAP.	0.01uF	50V	B	GRM40B103M50PT	K22170817		1-	
C 1228	CHIP CAP.	0.01uF	50V	B	GRM40B103M50PT	K22170817		1-	
C 1229	CHIP CAP.	0.01uF	50V	B	GRM40B103M50PT	K22170817		1-	
C 1230	CHIP CAP.	0.1uF	25V	F	GRM40F104Z25PT	K22141005		1-	
C 1231	CHIP CAP.	0.1uF	25V	F	GRM40F104Z25PT	K22141005		1-	
C 1232	CHIP CAP.	0.1uF	25V	F	GRM40F104Z25PT	K22141005		1-	
C 1233	CHIP CAP.	0.01uF	50V	B	GRM40B103M50PT	K22170817		1-	
C 1234	CHIP CAP.	0.01uF	50V	B	GRM40B103M50PT	K22170817		1-	
C 1235	CHIP CAP.	47pF	50V	CH	GRM40CH470J50PT	K22170227		1-	
C 1236	CHIP CAP.	68pF	50V	CH	GRM40CH680J50PT	K22170231		1-	
C 1237	CHIP CAP.	120pF	50V	CH	GRM40CH121J50PT	K22170237		1-	
C 1238	CHIP CAP.	22pF	50V	CH	GRM40CH220J50PT	K22170219		1-	
C 1239	CHIP CAP.	62pF	50V	CH	GRM40CH620J50PT	K22170230		1-	
C 1240	CHIP TA.CAP.	1uF	25V		TEMSVA1E105M-8R	K78140013		1-	
C 1241	CHIP CAP.	0.01uF	50V	B	GRM40B103M50PT	K22170817		1-	
C 1242	CHIP TA.CAP.	1uF	25V		TEMSVA1E105M-8R	K78140013		1-	
C 1243	CHIP CAP.	27pF	50V	CH	GRM40CH270J50PT	K22170221		1-	
C 1244	CHIP CAP.	0.01uF	50V	B	GRM40B103M50PT	K22170817		1-	
C 1248	CHIP CAP.	0.1uF	25V	F	GRM40F104Z25PT	K22141005		1-	
C 1249	CHIP CAP.	0.1uF	25V	F	GRM40F104Z25PT	K22141005		1-	
C 1250	CHIP CAP.	0.01uF	50V	B	GRM40B103M50PT	K22170817		1-	
C 1251	CHIP CAP.	10pF	50V	CH	GRM40CH100D50PT	K22170211		1-	
C 1252	CHIP CAP.	0.01uF	50V	B	GRM40B103M50PT	K22170817		1-	
C 1253	CHIP CAP.	8pF	50V	CH	GRM40CH080D50PT	K22170209		1-	
C 1254	CHIP CAP.	8pF	50V	CH	GRM40CH080D50PT	K22170209		1-	
C 1255	CHIP CAP.	15pF	50V	CH	GRM40CH150J50PT	K22170215		1-	
C 1256	CHIP CAP.	15pF	50V	CH	GRM40CH150J50PT	K22170215		1-	
C 1257	CHIP CAP.	33pF	50V	CH	GRM40CH330J50PT	K22170223		1-	
C 1258	CHIP CAP.	33pF	50V	CH	GRM40CH330J50PT	K22170223		1-	
C 1259	CHIP CAP.	68pF	50V	CH	GRM40CH680J50PT	K22170231		1-	
C 1260	CHIP CAP.	68pF	50V	CH	GRM40CH680J50PT	K22170231		1-	
C 1261	CHIP CAP.	120pF	50V	CH	GRM40CH121J50PT	K22170237		1-	
C 1262	CHIP CAP.	120pF	50V	CH	GRM40CH121J50PT	K22170237		1-	
C 1265	CHIP CAP.	0.01uF	50V	B	GRM40B103M50PT	K22170817		1-	
C 1266	CHIP CAP.	0.01uF	50V	B	GRM40B103M50PT	K22170817		1-	
C 1267	CHIP CAP.	0.01uF	50V	B	GRM40B103M50PT	K22170817		1-	
C 1268	CHIP CAP.	0.01uF	50V	B	GRM40B103M50PT	K22170817		1-	
C 1269	CHIP CAP.	0.01uF	50V	B	GRM40B103M50PT	K22170817		1-	
C 1270	CHIP CAP.	0.01uF	50V	B	GRM40B103M50PT	K22170817		1-	
C 1271	CHIP CAP.	0.01uF	50V	B	GRM40B103M50PT	K22170817		1-	
C 1272	CHIP CAP.	0.01uF	50V	B	GRM40B103M50PT	K22170817		1-	

RF Unit

Parts List

REF.	DESCRIPTION	VALUE	V/W	TOL.	MFR'S DESIG	YAESU P/N	VERS.	LOT.	LAY ADR
C 1273	CHIP CAP.	0.01uF	50V	B	GRM40B103M50PT	K22170817		1-	
C 1274	CHIP CAP.	0.01uF	50V	B	GRM40B103M50PT	K22170817		1-	
C 1275	CHIP CAP.	0.01uF	50V	B	GRM40B103M50PT	K22170817		1-	
C 1276	CHIP CAP.	0.01uF	50V	B	GRM40B103M50PT	K22170817		1-	
C 1277	CHIP TA.CAP.	10uF	20V		TEMSVB21D106M-8R	K78130028		1-	
C 1278	CHIP CAP.	0.1uF	25V	F	GRM40F104Z25PT	K22141005		1-	
C 1282	CHIP CAP.	220pF	50V	CH	GRM40CH221J50PT	K22170243		1-	
C 1283	CHIP CAP.	220pF	50V	CH	GRM40CH221J50PT	K22170243		1-	
C 1284	CHIP CAP.	47pF	50V	CH	GRM40CH470J50PT	K22170227		1-	
C 1285	CHIP CAP.	47pF	50V	CH	GRM40CH470J50PT	K22170227		1-	
C 1301	CHIP CAP.	0.1uF	25V	B	GRM40B104M25PT	K22140811		1-	
C 1302	CHIP TA.CAP.	10uF	16V		TEMSVB21C106M-8R	K78120025		1-	
C 1303	CHIP CAP.	0.01uF	50V	B	GRM40B103M50PT	K22170817		9-	
C 1304	CHIP CAP.	120pF	50V	CH	GRM40CH121J50PT	K22170237		9-	
C 1305	CHIP CAP.	47pF	50V	CH	GRM40CH470J50PT	K22170227		9-	
C 1306	CHIP CAP.	10pF	50V	CH	GRM40CH100D50PT	K22170211		9-	
C 1307	CHIP CAP.	0.01uF	50V	B	GRM40B103M50PT	K22170817		9-	
C 1308	CHIP CAP.	47pF	50V	CH	GRM40CH470J50PT	K22170227		9-	
C 1309	CHIP CAP.	120pF	50V	CH	GRM40CH121J50PT	K22170237		9-	
C 1310	CHIP CAP.	0.047uF	50V	F	GRM40F473Z50PT	K22171008		9-	
D 1001	DIODE				HSB88WSTR	G2070290		1-	b4
D 1002	DIODE				BAS316	G2070716		1-	g4
D 1003	DIODE				BAS316	G2070716		1-	g4
D 1004	DIODE				11ES1-TA1B2	G2060009		1-	A1
D 1005	DIODE				BAS316	G2070716		1-	a2
D 1005	DIODE				1SS270TJ	G2060004		6-	a2
D 1005	DIODE				1SS133 T-77	G2060001		27-	a2
D 1006	DIODE				1SV271 TPH3	G2070476		1-	a2
D 1007	DIODE				1SV271 TPH3	G2070476		1-	a2
D 1008	DIODE				1SV271 TPH3	G2070476		1-	d4
D 1009	DIODE				1SV271 TPH3	G2070476		1-	d3
D 1010	DIODE				1SV271 TPH3	G2070476		1-	d4
D 1011	DIODE				1SV271 TPH3	G2070476		1-	d3
D 1012	DIODE				1SV271 TPH3	G2070476		1-	d2
D 1013	DIODE				1SV271 TPH3	G2070476		1-	d4
D 1014	DIODE				1SV271 TPH3	G2070476		1-	d3
D 1015	DIODE				1SV271 TPH3	G2070476		1-	d3
D 1016	DIODE				1SV271 TPH3	G2070476		1-	d3
D 1017	DIODE				1SV271 TPH3	G2070476		1-	d3
D 1018	DIODE				1SS356TW11	G2070468		1-	E4
D 1019	DIODE				1SS356TW11	G2070468		1-	E4
D 1020	DIODE				1SS356TW11	G2070468		1-	E3
D 1021	DIODE				1SS356TW11	G2070468		1-	E4
D 1022	DIODE				1SS356TW11	G2070468		1-	E3
D 1023	DIODE				1SS356TW11	G2070468		1-	E3
D 1024	DIODE				1SS356TW11	G2070468		1-	E3
D 1025	DIODE				1SS356TW11	G2070468		1-	E3
D 1026	DIODE				1SS356TW11	G2070468		1-	E3
D 1027	DIODE				1SV271 TPH3	G2070476		1-	d2
D 1028	DIODE				1SV271 TPH3	G2070476		1-	d2
D 1029	DIODE				1SV271 TPH3	G2070476		1-	d2
D 1030	DIODE				1SV271 TPH3	G2070476		1-	d2
D 1031	DIODE				1SV271 TPH3	G2070476		1-	d2
D 1032	DIODE				1SS356TW11	G2070468		1-	E2
D 1033	DIODE				1SS356TW11	G2070468		1-	E2
D 1034	DIODE				1SS356TW11	G2070468		1-	E2
D 1035	DIODE				1SS356TW11	G2070468		1-	E2
D 1036	DIODE				1SS356TW11	G2070468		1-	E2
D 1037	DIODE				1SS356TW11	G2070468		1-	b3
D 1038	DIODE				1SS356TW11	G2070468		1-	b3
D 1039	DIODE				1SS356TW11	G2070468		1-	b2
D 1040	DIODE				1SS356TW11	G2070468		1-	a2
D 1041	DIODE				1SS356TW11	G2070468		1-	b3
D 1042	DIODE				1SV271 TPH3	G2070476		1-	b1
D 1043	DIODE				1SV271 TPH3	G2070476		1-	b1
D 1044	DIODE				1SV271 TPH3	G2070476		1-	b1
D 1045	DIODE				1SS356TW11	G2070468		1-	a2
D 1046	DIODE				1SS356TW11	G2070468		1-	b3

RF Unit

Parts List

REF.	DESCRIPTION	VALUE	V/W	TOL.	MFR'S DESIG	YAESU P/N	VERS.	LOT.	LAY ADR
D 1047	DIODE				1SS356TW11	G2070468		1-	b3
D 1048	DIODE				DAP202K T146	G2070180		1-	E1
D 1049	DIODE				BAS316	G2070716		1-	E1
D 1050	DIODE				BAS316	G2070716		1-	A3
D 1051	DIODE				BAS316	G2070716		1-	g3
D 1052	DIODE				BAS316	G2070716		1-	A2
D 1053	DIODE				BAS316	G2070716		1-	A2
D 1054	DIODE				BAS316	G2070716		1-	B2
D 1055	DIODE				D1N60-4070	G2060013		1-	B2
D 1056	DIODE				1SV271 TPH3	G2070476		1-	C2
D 1057	DIODE				BAS316	G2070716		1-	C2
D 1058	DIODE				BAS316	G2070716		1-	A4
D 1059	DIODE				BAS316	G2070716		1-	B4
D 1060	DIODE				BAS316	G2070716		1-	B4
D 1061	DIODE				BAS316	G2070716		1-	C4
D 1062	DIODE				BAS316	G2070716		1-	C4
D 1063	DIODE				BAS316	G2070716		1-	e2
D 1064	DIODE				BAS316	G2070716		1-	C2
D 1065	DIODE				BAS316	G2070716		1-	C2
D 1066	DIODE				BAS316	G2070716		1-	B2
D 1067	DIODE				BAS316	G2070716		1-	B2
D 1069	DIODE				BAS316	G2070716		9-	B1
D 1070	DIODE				BAS316	G2070716		9-	C2
D 1071	DIODE				BAS316	G2070716		9-	C1
D 1072	DIODE				BAS316	G2070716		9-	C1
D 1073	DIODE				BAS316	G2070716		9-	C2
D 1074	DIODE				BAS316	G2070716		9-	C2
F 1001	FUSE	0.5A			MF60NR250V 0.5A	Q0000001		1-	
FH1001	FUSE CLIP				PFC6000-0202	P2000050		1-	
J 1001	CONNECTOR				JPJ2545-01-510	P1090633		1-	
J 1002	CONNECTOR				JPJ2545-01-510	P1090633		1-	
J 1003	CONNECTOR				TMP-J01X-V6	P1090210		1-	
J 1004	CONNECTOR				JPJ2545-01-510	P1090633		1-	
J 1005	CONNECTOR				TMP-J01X-V6	P1090210		1-	
J 1006	CONNECTOR				JPJ2545-01-510	P1090633		1-	
J 1007	CONNECTOR				JPJ2545-01-510	P1090633		1-	
J 1009	CONNECTOR				20FMZ-BT	P1090903		1-	
J 1010	CONNECTOR				TMP-J01X-V6	P1090210		1-	
J 1011	CONNECTOR				TMP-J01X-V6	P1090210		1-	
J 1012	CONNECTOR				TMP-J01X-V6	P1090210		1-	
J 1013	CONNECTOR				TMP-J01X-V6	P1090210		1-	
J 1014	CONNECTOR				TCS5073-19-4151	P1090913		1-	
JP1001	WIRE ASSY				AH006H	T9206870		1-	
L 1001	CHIP COIL	10uH			LQH3N100K02M00-	L1690087		1-	
L 1002	TOROIDAL COIL	0.24uH			0.240U T25-6	L0021222		1-	
L 1003	TOROIDAL COIL	0.17uH			0.170U T25-6	L0021221		1-	
L 1004	CHIP COIL	4.7uH			LQH3N4R7M02M00-	L1690083		1-	
L 1005	CHIP COIL	100uH			LQH3N101K02M00-	L1690099		1-	
L 1006	CHIP COIL	100uH			LQH3N101K02M00-	L1690099		1-	
L 1007	CHIP COIL	100uH			LQH3N101K02M00-	L1690099		1-	
L 1008	CHIP COIL	10uH			LQH3N100K02M00-	L1690087		1-	
L 1009	CHIP COIL	1mH			LQH4N102K-S	L1690108		1-	
L 1010	COIL A1				8.5T5.0D0.6UEW R	L0022217		1-	
L 1011	CHIP COIL	10uH			LQH3N100K02M00-	L1690087		1-	
L 1012	CHIP COIL	10uH			LQH3N100K02M00-	L1690087		1-	
L 1013	CHIP COIL	10uH			LQH3N100K02M00-	L1690087		1-	
L 1014	COIL A1				6.5T3.0D0.6UEW R	L0021815A		1-	
L 1015	COIL A1				5.5T3.0D0.6UEW R	L0021814A		1-	
L 1016	COIL A1				5.5T3.5D0.6UEW R	L0021820A		1-	
L 1017	CHIP COIL	1mH			LQH4N102K-S	L1690108		1-	
L 1018	TOROIDAL COIL	0.24uH			0.240U T25-6	L0021222		1-	
L 1019	TOROIDAL COIL	0.28uH			0.280U T25-6	L0020927		1-	
L 1020	CHIP COIL	1mH			LQH4N102K-S	L1690108		1-	
L 1021	CHIP COIL	1mH			LQH4N102K-S	L1690108		1-	
L 1022	M.RFC	82uH			LAP02TA820K	L1790069		1-	
L 1023	M.RFC	100uH			LAP02TA101K	L1790070		1-	
L 1024	M.RFC	82uH			LAP02TA820K	L1790069		1-	
L 1025	CHIP COIL	1mH			LQH4N102K-S	L1690108		1-	

RF Unit

Parts List

REF.	DESCRIPTION	VALUE	V/W	TOL.	MFR'S DESIG	YAESU P/N	VERS.	LOT.	LAY ADR
L 1026	CHIP COIL	1mH			LQH4N102K-S	L1690108		1-	
L 1027	M.RFC	68uH			LAP02TA680K	L1790068		1-	
L 1028	M.RFC	27uH			LAP02TA270K	L1790063		1-	
L 1029	M.RFC	39uH			LAP02TA390K	L1790065		1-	
L 1030	M.RFC	27uH			LAP02TA270K	L1790063		1-	
L 1031	M.RFC	68uH			LAP02TA680K	L1790068		1-	
L 1032	M.RFC	33uH			LAP02TA330K	L1790064		1-	
L 1033	M.RFC	15uH			LAP02TA150K	L1790060		1-	
L 1034	M.RFC	33uH			LAP02TA330K	L1790064		1-	
L 1035	M.RFC	10uH			LAP02TA100K	L1790058		1-	
L 1036	M.RFC	27uH			LAP02TA270K	L1790063		1-	
L 1037	M.RFC	5.6uH			LAP02TA5R6K	L1790055		1-	
L 1038	M.RFC	27uH			LAP02TA270K	L1790063		1-	
L 1039	M.RFC	10uH			LAP02TA100K	L1790058		1-	
L 1040	M.RFC	6.8uH			LAP02TA6R8K	L1790056		1-	
L 1041	M.RFC	22uH			LAP02TA220K	L1790062		1-	
L 1042	M.RFC	3.3uH			LAP02TA3R3K	L1790052		1-	
L 1043	M.RFC	22uH			LAP02TA220K	L1790062		1-	
L 1044	M.RFC	6.8uH			LAP02TA6R8K	L1790056		1-	
L 1045	M.RFC	5.6uH			LAP02TA5R6K	L1790055		1-	
L 1046	M.RFC	12uH			LAP02TA120K	L1790059		1-	
L 1047	M.RFC	2.7uH			LAP02TA2R7K	L1790051		1-	
L 1048	M.RFC	12uH			LAP02TA120K	L1790059		1-	
L 1049	M.RFC	5.6uH			LAP02TA5R6K	L1790055		1-	
L 1050	M.RFC	1.8uH			LAP02TA1R8K	L1790049		1-	
L 1051	M.RFC	15uH			LAP02TA150K	L1790060		1-	
L 1052	M.RFC	1.2uH			LAP02TA1R2K	L1790047		1-	
L 1053	M.RFC	15uH			LAP02TA150K	L1790060		1-	
L 1054	M.RFC	1.8uH			LAP02TA1R8K	L1790049		1-	
L 1055	M.RFC	1.8uH			LAP02TA1R8K	L1790049		1-	
L 1056	M.RFC	10uH			LAP02TA100K	L1790058		1-	
L 1057	M.RFC	1uH			LAP02TA1R0K	L1790046		1-	
L 1058	M.RFC	10uH			LAP02TA100K	L1790058		1-	
L 1059	M.RFC	1.8uH			LAP02TA1R8K	L1790049		1-	
L 1060	M.RFC	1.2uH			LAP02TA1R2K	L1790047		1-	
L 1061	M.RFC	10uH			LAP02TA100K	L1790058		1-	
L 1062	M.RFC	0.68uH			LAP02TAR68K	L1790044		1-	
L 1063	M.RFC	10uH			LAP02TA100K	L1790058		1-	
L 1064	M.RFC	1.2uH			LAP02TA1R2K	L1790047		1-	
L 1065	M.RFC	1uH			LAP02TA1R0K	L1790046		1-	
L 1066	M.RFC	8.2uH			LAP02TA8R2K	L1790057		1-	
L 1067	M.RFC	0.56uH			LAP02TAR56K	L1790043		1-	
L 1068	M.RFC	8.2uH			LAP02TA8R2K	L1790057		1-	
L 1069	M.RFC	1uH			LAP02TA1R0K	L1790046		1-	
L 1070	M.RFC	1uH			LAP02TA1R0K	L1790046		1-	
L 1071	M.RFC	3.9uH			LAP02TA3R9K	L1790053		1-	
L 1072	M.RFC	0.56uH			LAP02TAR56K	L1790043		1-	
L 1073	M.RFC	3.9uH			LAP02TA3R9K	L1790053		1-	
L 1074	M.RFC	1uH			LAP02TA1R0K	L1790046		1-	
L 1075	M.RFC	0.56uH			LAP02TAR56K	L1790043		1-	
L 1076	M.RFC	3.9uH			LAP02TA3R9K	L1790053		1-	
L 1077	M.RFC	0.39uH			LAP02TAR39K	L1790041		1-	
L 1078	M.RFC	3.9uH			LAP02TA3R9K	L1790053		1-	
L 1079	M.RFC	0.56uH			LAP02TAR56K	L1790043		1-	
L 1080	M.RFC	1uH			LAP02TA1R0K	L1790046		1-	
L 1081	CHIP COIL	5.6uH			LQH3N5R6M02M00-	L1690084		1-	
L 1082	CHIP COIL	5.6uH			LQH3N5R6M02M00-	L1690084		1-	
L 1083	CHIP COIL	1mH			LQH4N102K-S	L1690108		1-	
L 1084	CHIP COIL	1mH			LQH4N102K-S	L1690108		1-	
L 1085	CHIP COIL	1mH			LQH4N102K-S	L1690108		1-	
L 1086	CHIP COIL	1mH			LQH4N102K-S	L1690108		1-	
L 1087	COIL A1				6.5T5.0D0.6UEW R	L0021833A		1-	
L 1088	COIL A1				8.5T5.0D0.6UEW R	L0022217		1-	
L 1089	M.RFC	1uH			LAP02TA1R0K	L1790046		1-	
Q 1001	FET				SST310-T1	G4070009		1-	b3
Q 1002	TRANSISTOR				2SC3356-T2B R25	G3333567E		1-	e4
Q 1003	TRANSISTOR				2SC2812L6-TA	G3328127F		1-	C4
Q 1003	TRANSISTOR				2SC2812NL6-TB	G3328128F		8-	C4

REF.	DESCRIPTION	VALUE	V/W	TOL.	MFR'S DESIG	YAESU P/N	VERS.	LOT.	LAY ADR
Q 1004	TRANSISTOR				2SC3356-T2B R25	G3333567E		1-	e4
Q 1005	TRANSISTOR				2SC2954-T2	G3329547		1-	B4
Q 1006	IC				UPD4011BG-T2	G1091026		1-	B1
Q 1007	TRANSISTOR				DTC144EU T106	G3070041		1-	g4
Q 1008	TRANSISTOR				2SD2403GY-T1	G3424038Y		1-	A2
Q 1009	FET				3SK131-T2B V12	G4801317B		1-	a4
Q 1010	FET				SST310-T1	G4070009		1-	a3
Q 1011	FET				SST310-T1	G4070009		1-	a3
Q 1012	FET				SST310-T1	G4070009		1-	a3
Q 1013	FET				SST310-T1	G4070009		1-	a3
Q 1014	TRANSISTOR				2SC2954-T2	G3329547		1-	F4
Q 1015	TRANSISTOR				2SA1179M6-TA	G3111797F		1-	a1
Q 1016	TRANSISTOR				2SC2812L6-TA	G3328127F		1-	G1
Q 1016	TRANSISTOR				2SC2812NL6-TB	G3328128F		8-	G1
Q 1017	TRANSISTOR				DTC144EU T106	G3070041		1-	a2
Q 1018	FET				3SK131-T2B V12	G4801317B		1-	b3
Q 1019	FET				SST310-T1	G4070009		1-	b2
Q 1020	FET				SST310-T1	G4070009		1-	b2
Q 1021	FET				SST310-T1	G4070009		1-	b2
Q 1022	FET				SST310-T1	G4070009		1-	b2
Q 1023	TRANSISTOR				DTC144EU T106	G3070041		1-	b2
Q 1024	TRANSISTOR				DTC144EU T106	G3070041		1-	b1
Q 1025	TRANSISTOR				DTA144EU T106	G3070079		1-	c1
Q 1026	TRANSISTOR				DTA144EU T106	G3070079		1-	c1
Q 1027	TRANSISTOR				DTA144EU T106	G3070079		1-	b1
Q 1028	FET				SST310-T1	G4070009		1-	b2
Q 1029	TRANSISTOR				DTC144EU T106	G3070041		1-	a2
Q 1030	IC				SN74LS145N	G1090395		1-	E1
Q 1031	TRANSISTOR				2SC2812L6-TA	G3328127F		1-	E1
Q 1031	TRANSISTOR				2SC2812NL6-TB	G3328128F		8-	E1
Q 1032	TRANSISTOR				DTC144EU T106	G3070041		1-	g3
Q 1033	IC				BU4094BCF-E2	G1092684		1-	C1
Q 1034	IC				BU4094BCF-E2	G1092684		1-	B1
Q 1040	TRANSISTOR				DTC144EU T106	G3070041		1-	B1
Q 1041	TRANSISTOR				DTC144EU T106	G3070041		1-	C1
Q 1042	TRANSISTOR				DTC144EU T106	G3070041		1-	C1
Q 1043	TRANSISTOR				DTC144EU T106	G3070041		1-	C1
Q 1044	TRANSISTOR				DTC144EU T106	G3070041		1-	B1
Q 1045	TRANSISTOR				DTC144EU T106	G3070041		1-	g2
R 1001	CHIP RES.	68	1/10W	5%	RMC1/10T 680J	J24205680		1-	
R 1002	CHIP RES.	100	1/10W	5%	RMC1/10T 101J	J24205101		1-	
R 1003	CHIP RES.	100k	1/10W	5%	RMC1/10T 104J	J24205104		1-	
R 1004	CHIP RES.	47k	1/10W	5%	RMC1/10T 473J	J24205473		1-	
R 1005	CHIP RES.	10	1/10W	5%	RMC1/10T 100J	J24205100		1-	
R 1006	CHIP RES.	10	1/10W	5%	RMC1/10T 100J	J24205100		1-	
R 1007	CHIP RES.	150	1/10W	5%	RMC1/10T 151J	J24205151		1-	
R 1008	CHIP RES.	10	1/10W	5%	RMC1/10T 100J	J24205100		1-	
R 1009	CHIP RES.	10	1/10W	5%	RMC1/10T 100J	J24205100		1-	
R 1010	CHIP RES.	150	1/10W	5%	RMC1/10T 151J	J24205151		1-	
R 1011	CHIP RES.	150	1/10W	5%	RMC1/10T 151J	J24205151		1-	
R 1012	CHIP RES.	2.2k	1/10W	5%	RMC1/10T 222J	J24205222		1-	
R 1013	CHIP RES.	2.2k	1/10W	5%	RMC1/10T 222J	J24205222		1-	
R 1014	CHIP RES.	1k	1/10W	5%	RMC1/10T 102J	J24205102		1-	
R 1015	CHIP RES.	1k	1/10W	5%	RMC1/10T 102J	J24205102		1-	
R 1016	CHIP RES.	47k	1/10W	5%	RMC1/10T 473J	J24205473		1-	
R 1017	CHIP RES.	470	1/10W	5%	RMC1/10T 471J	J24205471		1-	
R 1018	CHIP RES.	2.2k	1/10W	5%	RMC1/10T 222J	J24205222		1-	
R 1019	CHIP RES.	4.7k	1/10W	5%	RMC1/10T 472J	J24205472		1-	
R 1020	CHIP RES.	47	1/10W	5%	RMC1/10T 470J	J24205470		1-	
R 1021	CHIP RES.	560	1/10W	5%	RMC1/10T 561J	J24205561		1-	
R 1022	CHIP RES.	47	1/10W	5%	RMC1/10T 470J	J24205470		1-	
R 1023	CHIP RES.	100	1/2W	5%	RMC1/2 101JCTP	J24275101		1-	
R 1024	CHIP RES.	680	1/10W	5%	RMC1/10T 681J	J24205681		1-	
R 1025	CHIP RES.	56	1/10W	5%	RMC1/10T 560J	J24205560		1-	
R 1026	CHIP RES.	22	1/10W	5%	RMC1/10T 220J	J24205220		1-	
R 1027	CHIP RES.	39	1/10W	5%	RMC1/10T 390J	J24205390		1-	
R 1028	CHIP RES.	22	1/10W	5%	RMC1/10T 220J	J24205220		1-	
R 1029	CHIP RES.	47k	1/10W	5%	RMC1/10T 473J	J24205473		1-	

RF Unit

Parts List

REF.	DESCRIPTION	VALUE	V/W	TOL.	MFR'S DESIG	YAESU P/N	VERS.	LOT.	LAY ADR
R 1030	CHIP RES.	47k	1/10W	5%	RMC1/10T 473J	J24205473		1-	
R 1031	CHIP RES.	47k	1/10W	5%	RMC1/10T 473J	J24205473		1-	
R 1032	CHIP RES.	27k	1/10W	5%	RMC1/10T 273J	J24205273		1-	
R 1033	CHIP RES.	47k	1/10W	5%	RMC1/10T 473J	J24205473		1-	
R 1034	CHIP RES.	1k	1/10W	5%	RMC1/10T 102J	J24205102		1-	
R 1035	CHIP RES.	1k	1/10W	5%	RMC1/10T 102J	J24205102		1-	
R 1036	CHIP RES.	1k	1/10W	5%	RMC1/10T 102J	J24205102		1-	
R 1037	CHIP RES.	1k	1/10W	5%	RMC1/10T 102J	J24205102		1-	
R 1038	CHIP RES.	1k	1/10W	5%	RMC1/10T 102J	J24205102		1-	
R 1039	CHIP RES.	4.7k	1/10W	5%	RMC1/10T 472J	J24205472		1-	
R 1040	CHIP RES.	100	1/10W	5%	RMC1/10T 101J	J24205101		1-	
R 1041	CHIP RES.	10k	1/10W	5%	RMC1/10T 103J	J24205103		1-	
R 1042	CHIP RES.	150	1/10W	5%	RMC1/10T 151J	J24205151		1-	
R 1043	CHIP RES.	470k	1/10W	5%	RMC1/10T 474J	J24205474		1-	
R 1044	CHIP RES.	33k	1/10W	5%	RMC1/10T 333J	J24205333		1-	
R 1045	CHIP RES.	100k	1/10W	5%	RMC1/10T 104J	J24205104		1-	
R 1046	CHIP RES.	10k	1/10W	5%	RMC1/10T 103J	J24205103		1-	
R 1047	CHIP RES.	15k	1/10W	5%	RMC1/10T 153J	J24205153		1-	
R 1048	CHIP RES.	680	1/10W	5%	RMC1/10T 681J	J24205681		1-	
R 1049	CHIP RES.	680	1/10W	5%	RMC1/10T 681J	J24205681		1-	
R 1050	CHIP RES.	680	1/10W	5%	RMC1/10T 681J	J24205681		1-	
R 1051	CHIP RES.	680	1/10W	5%	RMC1/10T 681J	J24205681		1-	
R 1052	CHIP RES.	47	1/10W	5%	RMC1/10T 470J	J24205470		1-	
R 1053	CHIP RES.	100k	1/10W	5%	RMC1/10T 104J	J24205104		1-	
R 1054	CHIP RES.	100k	1/10W	5%	RMC1/10T 104J	J24205104		1-	
R 1055	CHIP RES.	0	1/10W	5%	RMC1/10T 000J	J24205000		1-	
R 1057	CHIP RES.	56	1/10W	5%	RMC1/10T 560J	J24205560		1-	
R 1058	CHIP RES.	0	1/10W	5%	RMC1/10T 000J	J24205000		1-	
R 1059	CHIP RES.	680	1/10W	5%	RMC1/10T 681J	J24205681		1-	
R 1060	CHIP RES.	470	1/10W	5%	RMC1/10T 471J	J24205471		1-	
R 1061	CHIP RES.	4.7	1/10W	5%	RMC1/10T 4R7J	J24205479		1-	
R 1062	CHIP RES.	100	1/4W	5%	RMC1/4 101JATP	J24245101		1-	
R 1063	CHIP RES.	180	1/10W	5%	RMC1/10T 181J	J24205181		1-	
R 1064	CHIP RES.	47	1/10W	5%	RMC1/10T 470J	J24205470		1-	
R 1065	CHIP RES.	15	1/10W	5%	RMC1/10T 150J	J24205150		1-	
R 1066	CHIP RES.	100	1/10W	5%	RMC1/10T 101J	J24205101		1-	
R 1067	CHIP RES.	100	1/10W	5%	RMC1/10T 101J	J24205101		1-	
R 1068	CHIP RES.	100	1/10W	5%	RMC1/10T 101J	J24205101		1-	
R 1069	CHIP RES.	10k	1/10W	5%	RMC1/10T 103J	J24205103		1-	
R 1070	CHIP RES.	0	1/10W	5%	RMC1/10T 000J	J24205000		1-	
R 1071	CHIP RES.	22k	1/10W	5%	RMC1/10T 223J	J24205223		1-	
R 1072	CHIP RES.	470	1/10W	5%	RMC1/10T 471J	J24205471		1-	
R 1073	CHIP RES.	2.7k	1/10W	5%	RMC1/10T 272J	J24205272		1-	
R 1074	CHIP RES.	10k	1/10W	5%	RMC1/10T 103J	J24205103		1-	
R 1075	CHIP RES.	18k	1/10W	5%	RMC1/10T 183J	J24205183		1-	
R 1076	CHIP RES.	47k	1/10W	5%	RMC1/10T 473J	J24205473		1-	
R 1077	CHIP RES.	1k	1/10W	5%	RMC1/10T 102J	J24205102		1-	
R 1078	CHIP RES.	10k	1/10W	5%	RMC1/10T 103J	J24205103		1-	
R 1079	CHIP RES.	330	1/2W	5%	RMC1/2 331JCTP	J24275331		1-	
R 1080	CHIP RES.	180	1/4W	5%	RMC1/4 181JATP	J24245181		1-	
R 1081	CHIP RES.	12	1/10W	5%	RMC1/10T 120J	J24205120		1-	
R 1082	CHIP RES.	270	1/10W	5%	RMC1/10T 271J	J24205271		1-	
R 1083	CHIP RES.	390	1/10W	5%	RMC1/10T 391J	J24205391		1-	
R 1084	CHIP RES.	390	1/10W	5%	RMC1/10T 391J	J24205391		1-	
R 1085	CHIP RES.	120	1/10W	5%	RMC1/10T 121J	J24205121		1-	
R 1086	CHIP RES.	22	1/10W	5%	RMC1/10T 220J	J24205220		1-	
R 1087	CHIP RES.	39	1/10W	5%	RMC1/10T 390J	J24205390		1-	
R 1088	CHIP RES.	100	1/10W	5%	RMC1/10T 101J	J24205101		1-	
R 1089	CHIP RES.	22	1/10W	5%	RMC1/10T 220J	J24205220		1-	
R 1090	CHIP RES.	100	1/10W	5%	RMC1/10T 101J	J24205101		1-	
R 1091	CHIP RES.	22	1/10W	5%	RMC1/10T 220J	J24205220		1-	
R 1092	CHIP RES.	100	1/10W	5%	RMC1/10T 101J	J24205101		1-	
R 1093	CHIP RES.	22	1/10W	5%	RMC1/10T 220J	J24205220		1-	
R 1094	CHIP RES.	100	1/10W	5%	RMC1/10T 101J	J24205101		1-	
R 1095	CHIP RES.	22	1/10W	5%	RMC1/10T 220J	J24205220		1-	
R 1096	CHIP RES.	100	1/10W	5%	RMC1/10T 101J	J24205101		1-	
R 1097	CHIP RES.	22	1/10W	5%	RMC1/10T 220J	J24205220		1-	
R 1098	CHIP RES.	100	1/10W	5%	RMC1/10T 101J	J24205101		1-	

RF Unit

Parts List

REF.	DESCRIPTION	VALUE	V/W	TOL.	MFR'S DESIG	YAESU P/N	VERS.	LOT.	LAY ADR
R 1099	CHIP RES.	22	1/10W	5%	RMC1/10T 220J	J24205220		1-	
R 1100	CHIP RES.	100	1/10W	5%	RMC1/10T 101J	J24205101		1-	
R 1101	CHIP RES.	22	1/10W	5%	RMC1/10T 220J	J24205220		1-	
R 1102	CHIP RES.	100	1/10W	5%	RMC1/10T 101J	J24205101		1-	
R 1103	CHIP RES.	22	1/10W	5%	RMC1/10T 220J	J24205220		1-	
R 1104	CHIP RES.	100	1/10W	5%	RMC1/10T 101J	J24205101		1-	
R 1105	CHIP RES.	22	1/10W	5%	RMC1/10T 220J	J24205220		1-	
R 1106	CHIP RES.	270	1/2W	5%	RMC1/2 271JTE	J24275271		1-	
R 1107	CHIP RES.	330	1/2W	5%	RMC1/2 331JCTP	J24275331		1-	
R 1108	CHIP RES.	10k	1/10W	5%	RMC1/10T 103J	J24205103		1-	
R 1109	CHIP RES.	120k	1/10W	5%	RMC1/10T 124J	J24205124		1-	
R 1110	CHIP RES.	22k	1/10W	5%	RMC1/10T 223J	J24205223		1-	
R 1111	CHIP RES.	47k	1/10W	5%	RMC1/10T 473J	J24205473		1-	
R 1112	CHIP RES.	220	1/10W	5%	RMC1/10T 221J	J24205221		1-	
R 1113	CHIP RES.	100	1/10W	5%	RMC1/10T 101J	J24205101		1-	
R 1114	CHIP RES.	10k	1/10W	5%	RMC1/10T 103J	J24205103		1-	
R 1115	CHIP RES.	47	1/4W	5%	RMC1/4 470JATP	J24245470		1-	
R 1116	CHIP RES.	220	1/10W	5%	RMC1/10T 221J	J24205221		1-	
R 1117	CHIP RES.	82k	1/10W	5%	RMC1/10T 823J	J24205823		1-	
R 1118	CHIP RES.	100k	1/10W	5%	RMC1/10T 104J	J24205104		1-	
R 1119	CHIP RES.	15	1/4W	5%	RMC1/4 150JATP	J24245150		1-	
R 1120	CHIP RES.	10k	1/10W	5%	RMC1/10T 103J	J24205103		1-	
R 1121	CHIP RES.	220	1/4W	5%	RMC1/4 221JATP	J24245221		1-	
R 1122	CHIP RES.	2.2k	1/10W	5%	RMC1/10T 222J	J24205222		1-	
R 1123	CHIP RES.	220	1/4W	5%	RMC1/4 221JATP	J24245221		1-	
R 1124	CHIP RES.	1.5k	1/10W	5%	RMC1/10T 152J	J24205152		1-	
R 1125	CHIP RES.	220	1/4W	5%	RMC1/4 221JATP	J24245221		1-	
R 1126	CHIP RES.	220	1/4W	5%	RMC1/4 221JATP	J24245221		1-	
R 1127	CHIP RES.	4.7k	1/10W	5%	RMC1/10T 472J	J24205472		1-	
R 1128	CHIP RES.	47k	1/10W	5%	RMC1/10T 473J	J24205473		1-	
R 1129	CHIP RES.	47k	1/10W	5%	RMC1/10T 473J	J24205473		1-	
R 1130	CHIP RES.	47k	1/10W	5%	RMC1/10T 473J	J24205473		1-	
R 1131	CHIP RES.	100k	1/10W	5%	RMC1/10T 104J	J24205104		1-	
R 1132	CHIP RES.	82	1/10W	5%	RMC1/10T 820J	J24205820		1-	
R 1133	CHIP RES.	100k	1/10W	5%	RMC1/10T 104J	J24205104		1-	
R 1134	CHIP RES.	100	1/10W	5%	RMC1/10T 101J	J24205101		1-	
R 1135	CHIP RES.	10k	1/10W	5%	RMC1/10T 103J	J24205103		1-	
R 1136	CHIP RES.	10k	1/10W	5%	RMC1/10T 103J	J24205103		1-	
R 1137	CHIP RES.	4.7k	1/10W	5%	RMC1/10T 472J	J24205472		1-	
R 1138	CHIP RES.	4.7k	1/10W	5%	RMC1/10T 472J	J24205472		1-	
R 1139	CHIP RES.	4.7k	1/10W	5%	RMC1/10T 472J	J24205472		1-	
R 1140	CHIP RES.	4.7k	1/10W	5%	RMC1/10T 472J	J24205472		1-	
R 1141	CHIP RES.	4.7k	1/10W	5%	RMC1/10T 472J	J24205472		1-	
R 1142	CHIP RES.	4.7k	1/10W	5%	RMC1/10T 472J	J24205472		1-	
R 1143	CHIP RES.	4.7k	1/10W	5%	RMC1/10T 472J	J24205472		1-	
R 1144	CHIP RES.	4.7k	1/10W	5%	RMC1/10T 472J	J24205472		1-	
R 1145	CHIP RES.	4.7k	1/10W	5%	RMC1/10T 472J	J24205472		1-	
R 1146	CHIP RES.	4.7k	1/10W	5%	RMC1/10T 472J	J24205472		1-	
R 1147	CHIP RES.	4.7k	1/10W	5%	RMC1/10T 472J	J24205472		1-	
R 1148	CHIP RES.	3.3k	1/10W	5%	RMC1/10T 332J	J24205332		1-	
R 1149	CHIP RES.	2.2k	1/10W	5%	RMC1/10T 222J	J24205222		1-	
R 1150	CHIP RES.	100	1/10W	5%	RMC1/10T 101J	J24205101		1-	
R 1151	CHIP RES.	47	1/10W	5%	RMC1/10T 470J	J24205470		1-	
R 1152	CHIP RES.	100	1/10W	5%	RMC1/10T 101J	J24205101		1-	
R 1153	CHIP RES.	150	1/10W	5%	RMC1/10T 151J	J24205151		1-	
R 1154	CHIP RES.	68	1/10W	5%	RMC1/10T 680J	J24205680		1-	
R 1155	CHIP RES.	100	1/10W	5%	RMC1/10T 101J	J24205101		1-	
R 1156	CHIP RES.	100	1/10W	5%	RMC1/10T 101J	J24205101		1-	
R 1157	CHIP RES.	100	1/2W	5%	RMC1/2 101JCTP	J24275101		1-	
R 1158	CHIP RES.	330	1/2W	5%	RMC1/2 331JCTP	J24275331		1-	
R 1159	CHIP RES.	10k	1/10W	5%	RMC1/10T 103J	J24205103		1-	
R 1160	CHIP RES.	10k	1/10W	5%	RMC1/10T 103J	J24205103		1-	
R 1161	CHIP RES.	180	1/4W	5%	RMC1/4 181JATP	J24245181		1-	
R 1162	CHIP RES.	100	1/10W	5%	RMC1/10T 101J	J24205101		1-	
R 1163	CHIP RES.	330	1/10W	5%	RMC1/10T 331J	J24205331		1-	
R 1164	CHIP RES.	330	1/10W	5%	RMC1/10T 331J	J24205331		1-	
R 1165	CHIP RES.	330	1/10W	5%	RMC1/10T 331J	J24205331		1-	
R 1166	CHIP RES.	0	1/10W	5%	RMC1/10T 000J	J24205000		1-	

RF Unit

Parts List

REF.	DESCRIPTION	VALUE	V/W	TOL.	MFR'S DESIG	YAESU P/N	VERS.	LOT.	LAY ADR
R 1166	CHIP RES.	47	1/10W	5%	RMC1/10T 470J	J24205470		6-	
R 1167	CHIP RES.	0	1/10W	5%	RMC1/10T 000J	J24205000		1-	
R 1168	CHIP RES.	0	1/10W	5%	RMC1/10T 000J	J24205000		1-	
R 1169	CHIP RES.	0	1/10W	5%	RMC1/10T 000J	J24205000		1-	
R 1170	CHIP RES.	0	1/10W	5%	RMC1/10T 000J	J24205000		1-	
R 1171	CHIP RES.	0	1/10W	5%	RMC1/10T 000J	J24205000		1-	
R 1173	CHIP RES.	0	1/10W	5%	RMC1/10T 000J	J24205000		1-	
R 1175	CHIP RES.	47	1/10W	5%	RMC1/10T 470J	J24205470		1-	
R 1176	CARBON FILM RES.	560	1/6W	5%	RD16TPJ561 560	J07225561		6-	
R 1176	CHIP RES.	10	1/10W	5%	RMC1/10T 100J	J24205100		9-	
R 1177	CARBON FILM RES.	560	1/6W	5%	RD16TPJ561 560	J07225561		9-	
RL1001	RELAY		DC12V		AG4013 DC12V	M1190090		1-	
RL1002	RELAY		DC12V		ATX203 DC12V	M1190163		1-	
RL1003	RELAY		DC12V		AG4013 DC12V	M1190090		1-	
RL1004	RELAY		DC12V		AG4013 DC12V	M1190090		1-	
RL1005	RELAY		DC12V		ATX203 DC12V	M1190163		1-	
RL1006	RELAY		DC12V		ATX203 DC12V	M1190163		1-	
RL1007	RELAY		DC12V		ATX203 DC12V	M1190163		1-	
RL1008	RELAY		DC12V		ATX203 DC12V	M1190163		1-	
RL1009	RELAY		DC12V		ATX203 DC12V	M1190163		1-	
RL1010	RELAY		DC12V		ATX203 DC12V	M1190163		1-	
RL1011	RELAY		DC12V		ATX203 DC12V	M1190163		1-	
RL1012	RELAY		DC12V		ATX203 DC12V	M1190163		1-	
RL1013	RELAY		DC12V		ATX203 DC12V	M1190163		1-	
RL1014	RELAY		DC12V		ATX203 DC12V	M1190163		1-	
RL1015	RELAY		DC12V		ATX203 DC12V	M1190163		1-	
RL1016	RELAY		DC12V		AHY123 DC12V	M1190149		9-	
RL1017	RELAY		DC12V		AHY123 DC12V	M1190149		9-	
RL1018	RELAY		DC12V		AHY123 DC12V	M1190149		9-	
S 1001	SLIDE SWITCH				SSSS912N-2A-OR	N6090094		1-	
T 1001	COIL 07RF				R12-J758A	L0021958		1-	
T 1002	COIL 07RF	73.62MHz			73.62M R12-J757A	L0021957		1-	
T 1003	COIL 07WIDE				4-1 2D3 TR6X3	L0020788A		1-	
T 1004	COIL 07WIDE				4-1 2D3 TR6X3	L0020788A		1-	
T 1005	COIL 07RF	73.62MHz			73.62M R12-J757A	L0021957		1-	
T 1006	COIL 07RF	73.62MHz			73.62M S-135-214	L0021960		1-	
T 1007	COIL 07RF	73.62MHz			73.62M S-135-214	L0021960		1-	
T 1008	COIL 07RF	73.62MHz			73.62M S-135-214	L0021960		1-	
T 1009	COIL 07RF	73.62MHz			73.62M R12-J757A	L0021957		1-	
T 1010	COIL WIDE-TRANS.				4-1 3A	L0021462		1-	
T 1011	COIL 07WIDE				4-1 2D3 TR6X3	L0020788A		1-	
T 1012	COIL 07WIDE				4-1 2D3 TR6X3	L0020788A		1-	
T 1013	COIL 10WIDE				3A 9X5X5	L0021959		1-	
T 1014	COIL 10WIDE				9-1 2001F	L0021605		1-	
T 1015	COIL 07WIDE				4-1 2001F FR6	L0021351		1-	
T 1016	COIL 07RF				38M R12-P705A	L0022348		1-	
T 1017	COIL 07WIDE				2289-JPS-014	L0022351		1-	
T 1018	COIL 07WIDE				2001F	L0021974		1-	
T 1019	COIL 07WIDE				2001F	L0021973		1-	
T 1020	COIL 10RF				10U	L0022350		1-	
T 1021	COIL 07RF	5.6uH			5.6U	L0022378		1-	
T 1022	COIL 07RF	2.5uH			2.5U	L0022349		1-	
T 1023	COIL 10WIDE				9-1 2001F	L0021605		9-	
T 1024	COIL 10WIDE				9-1 2001F	L0021605		9-	
T 1025	COIL 07WIDE				4-1 2001F FR6	L0021351		1-	
T 1026	COIL 10RF	20uH			20U R12-T653X	L0022665		1-	
T 1027	COIL 10RF	20uH			20U R12-T653X	L0022665		1-	
T 1028	COIL 10RF	5.45uH			5.45U R12-T654X	L0022666		1-	
T 1029	COIL 10RF	5.45uH			5.45U R12-T654X	L0022666		1-	
T 1030	COIL 10RF	2.6uH			2.6U R12-T681X	L0022669		1-	
T 1031	COIL 10RF	2.6uH			2.6U R12-T681X	L0022669		1-	
T 1032	COIL 10RF	1.4uH			1.4U R12-T655X	L0022667		1-	
T 1033	COIL 10RF	1.4uH			1.4U R12-T655X	L0022667		1-	
T 1034	COIL 10RF	0.65uH			0.65U R12-T656X	L0022668		1-	
T 1035	COIL 10RF	0.65uH			0.65U R12-T656X	L0022668		1-	
TH1001	THERMISTOR				157-102-53012TP	G9090071		1-	
VR1001	POT.	4.7k			RH03A3AS3X 4.7K	J51807472		1-	
VR1002	POT.	4.7k			RH03A3AS3X 4.7K	J51807472		1-	

RF Unit

Parts List

REF.	DESCRIPTION	VALUE	V/W	TOL.	MFR'S DESIG	YAESU P/N	VERS.	LOT.	LAY ADR
XF1001	XTAL FILTER				70R12BUF	H1102202		1-	
XF1002	XTAL FILTER				70R12BUF	H1102202		1-	
	SHIELD CASE					R0131670A		1-	
	SHIELD CASE					R0136980A		1-	
	SHIELD CASE COVER					R0136990		1-	
	LEAF SPRING					R0120250		1-	
	LEAF SPRING					R0140030	W/ CE LABEL	10-	
	LEAF SPRING					R0140030	W/ CE LABEL	10-	

RF Unit

Note

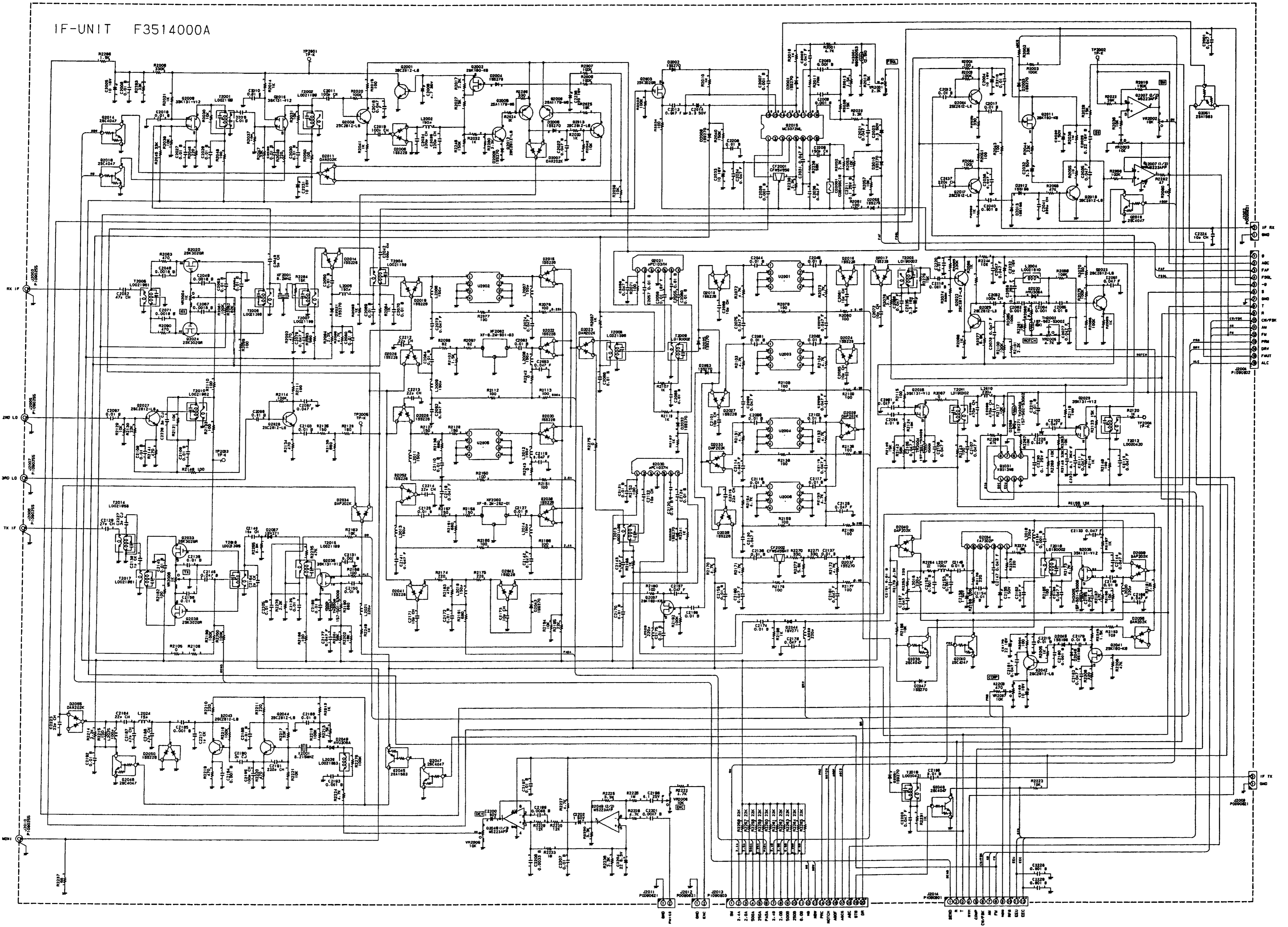

IF-UNIT F3514000A

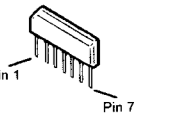

TA7302P
(Q2034)

UPC1037H
(Q2021, Q2030)

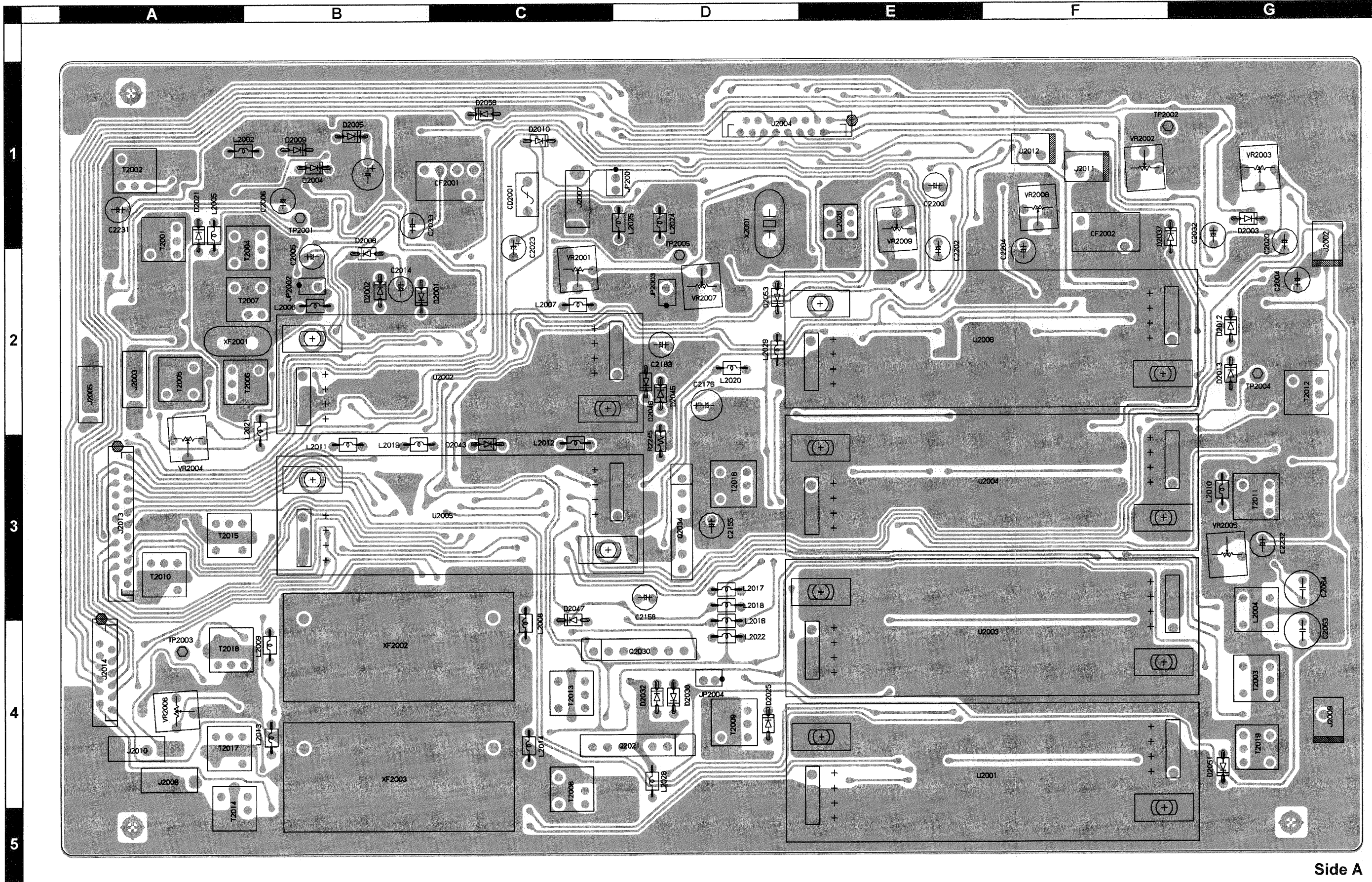

Side A

IF Unit (Lot. 1~)

Parts Layout

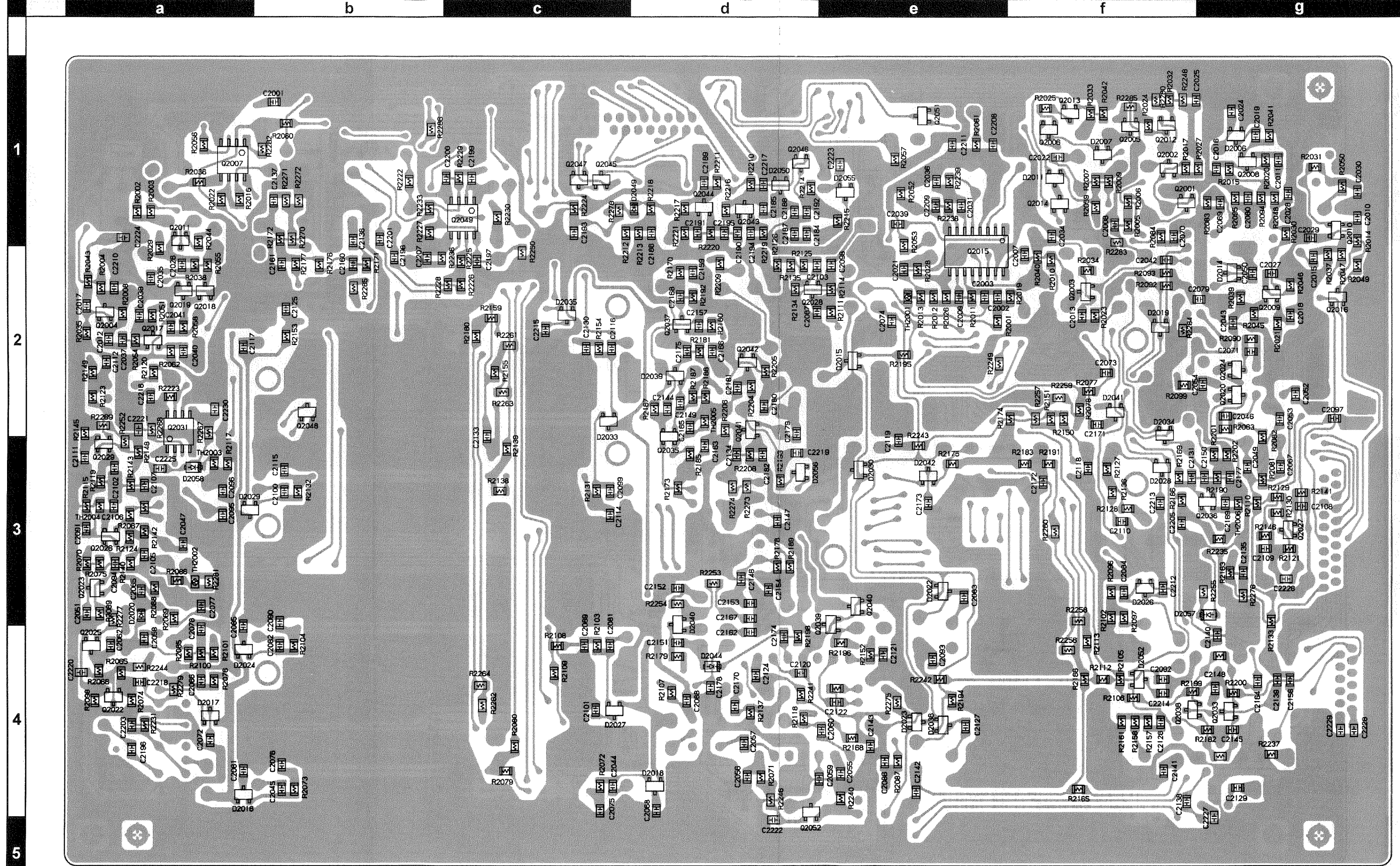

Side B

IF-UNIT F3514000C

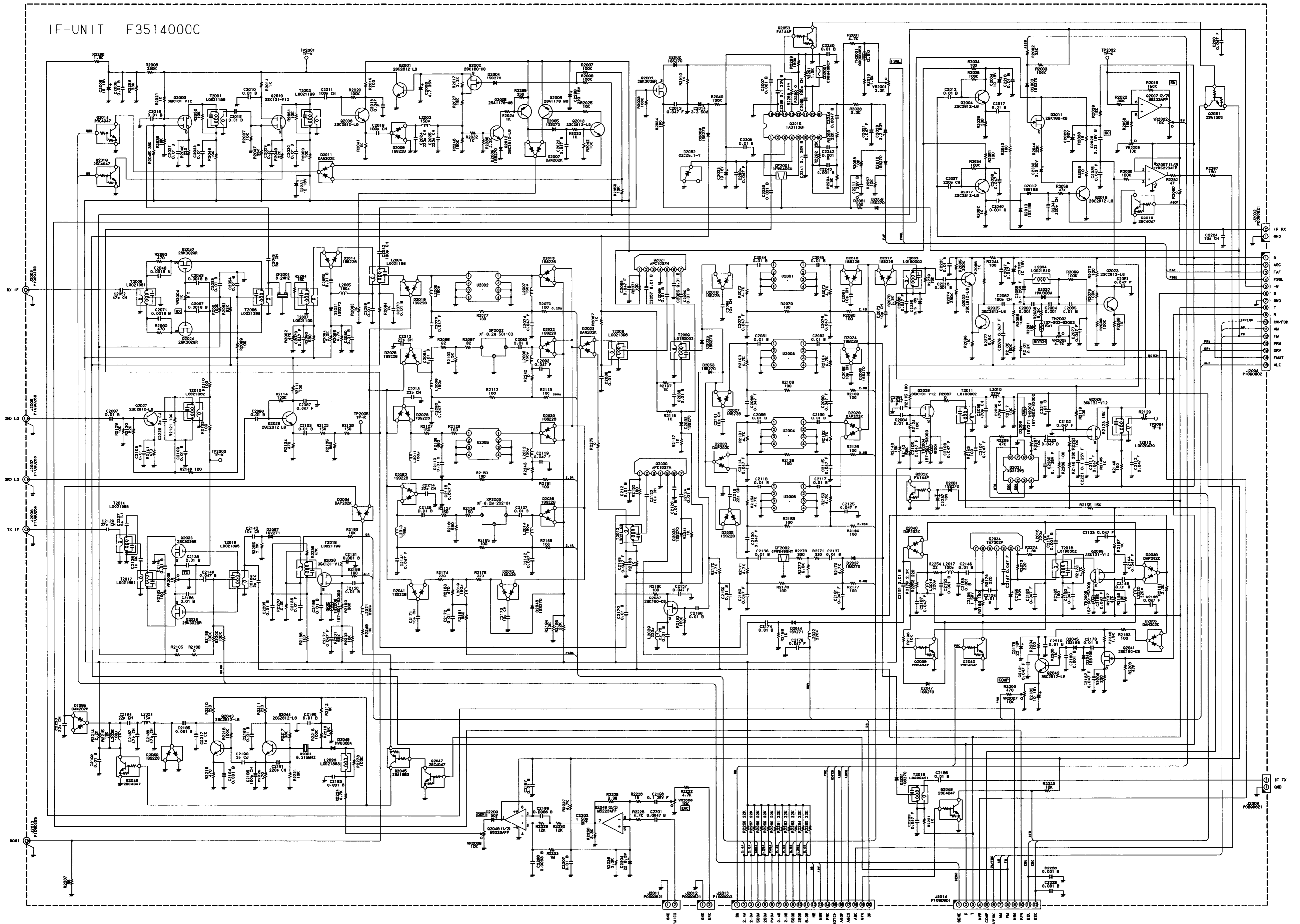

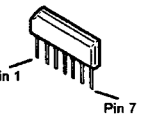

TA7302P
(Q2034)

UPC1037H
(Q2021, Q2030)

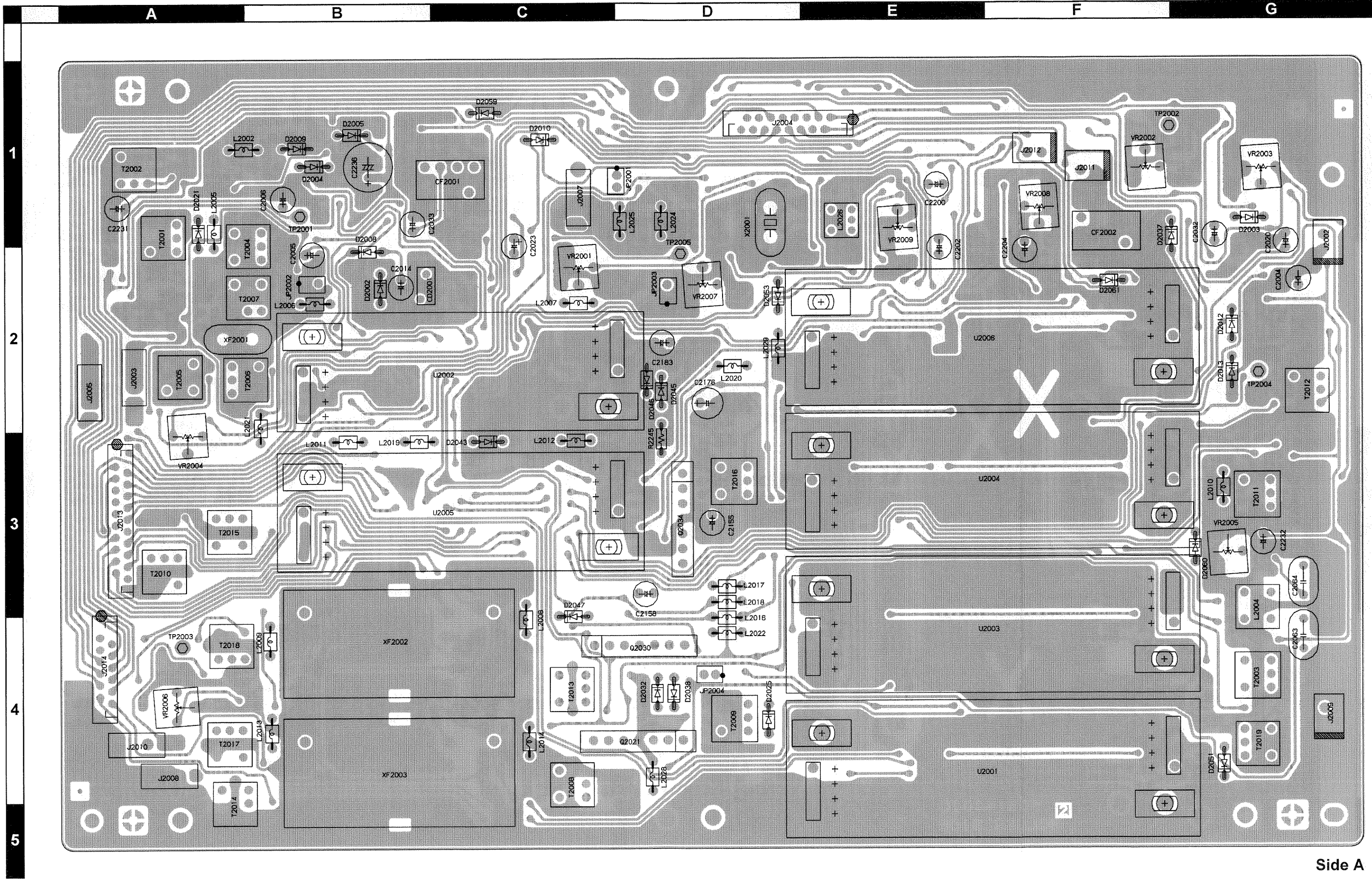

Side A

IF Unit (Lot. 32~)

Parts Layout

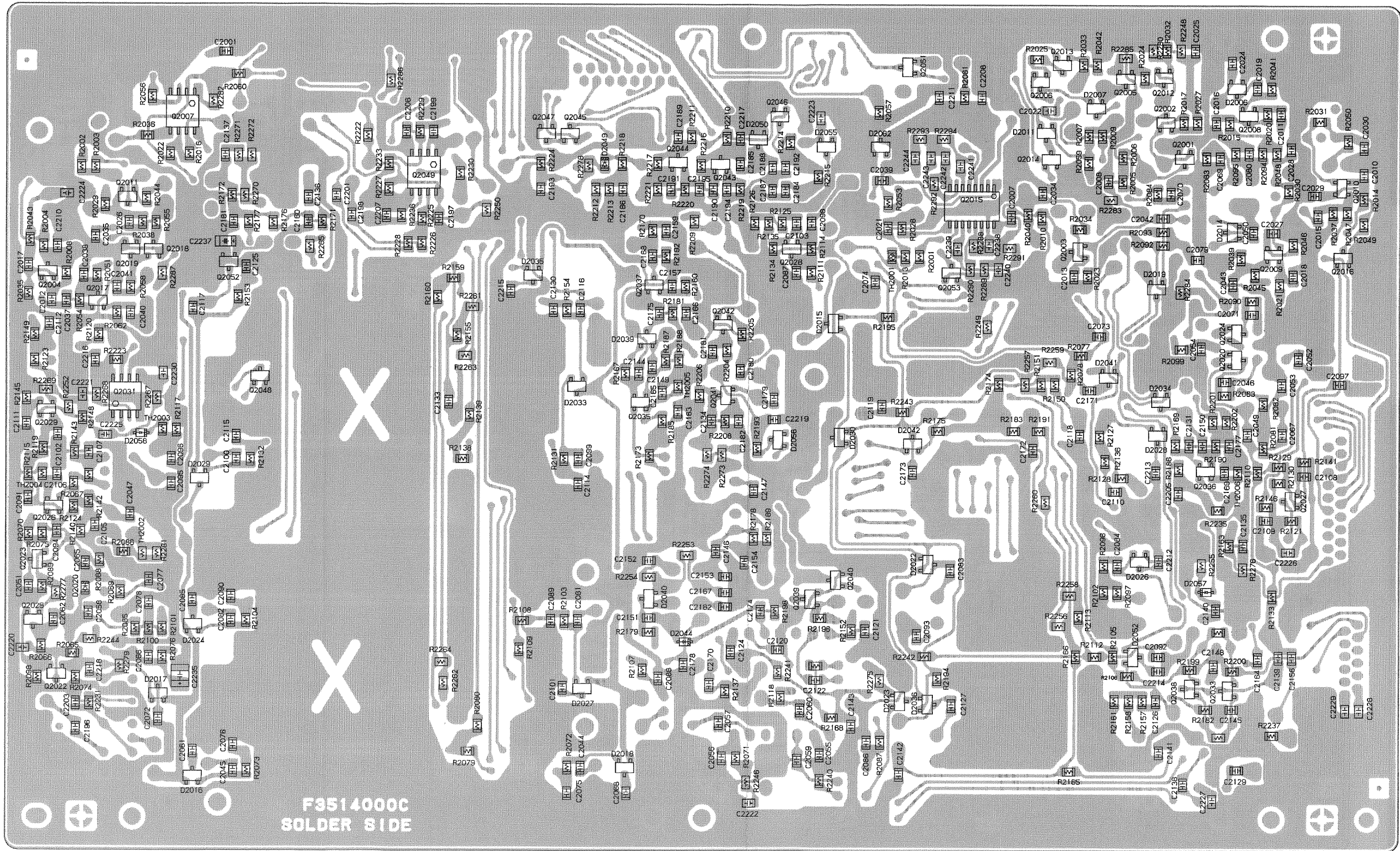

Side B

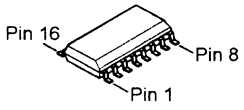

TA31136F
(Q2015)

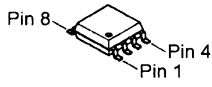

M5223AFP 600C
(Q2007, 2049)
X9313WS
(Q2031)

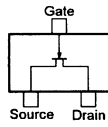

2SK160 (K6)
(Q2002, 2011
2037, 2041)

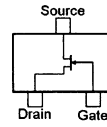

2SK302GR (TY)
(Q2003, 2020,
2024, 2033, 2038)

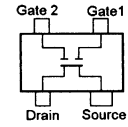

3SK131 (V12)
(Q2009, 2010, 2026,
2029, 2035, 2036)

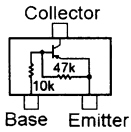

2SA1563-TB
(Q2045, 2051)

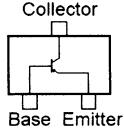

2SA1179 (M6)
(Q2005, 2006)
2SC2812 (L6)
(Q2001, 2004, 2008,
2012, 2013, 2017,
2018, 2022, 2023,
2025, 2027, 2028,
2042, 2043, 2044)

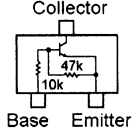

UN2214 (8D)
(Q2014, 2016,
2019, 2039, 2040,
2046, 2047, 2048)

IF Unit

Parts List

REF.	DESCRIPTION	VALUE	V/W	TOL.	MFR'S DESIG	YAESU P/N	VERS.	LOT.	LAY ADR
PCB with Components (W/ SSB-FILTER UNNIT)						CP6679001			
PCB with Components (W/O SSB-FILTER UNNIT)						CB1188001			
Printed Circuit Board						F3514000A		1	
Printed Circuit Board						F3514000C		32-	
C 2001	CHIP CAP.	0.047uF	50V	F	GRM40F473Z50PT	K22171008		1-	
C 2002	CHIP CAP.	0.047uF	50V	F	GRM40F473Z50PT	K22171008		1-	
C 2003	CHIP CAP.	0.001uF	50V	B	GRM40B102M50PT	K22170805		1-	
C 2004	AL.ELECTRO.CAP.	10uF	16V		16V100M4X7TR2	K46120004		1-	
C 2005	AL.ELECTRO.CAP.	10uF	16V		16V100M4X7TR2	K46120004		1-	
C 2006	AL.ELECTRO.CAP.	4.7uF	35V		35V4R7M4X7TR2	K46160004		1-	
C 2007	CHIP CAP.	0.001uF	50V	B	GRM40B102M50PT	K22170805		1-	
C 2008	CHIP CAP.	0.01uF	50V	B	GRM40B103M50PT	K22170817		1-	
C 2009	CHIP CAP.	0.001uF	50V	B	GRM40B102M50PT	K22170805		1-	
C 2010	CHIP CAP.	0.01uF	50V	B	GRM40B103M50PT	K22170817		1-	
C 2011	CHIP CAP.	100pF	50V	CH	GRM40CH101J50PT	K22170235		1-	
C 2012	CHIP CAP.	0.01uF	50V	B	GRM40B103M50PT	K22170817		1-	
C 2013	CHIP CAP.	0.047uF	50V	F	GRM40F473Z50PT	K22171008		1-	
C 2014	AL.ELECTRO.CAP.	3.3uF	50V		50V3R3M4X7TR2	K46170032		1-	
C 2015	CHIP CAP.	0.01uF	50V	B	GRM40B103M50PT	K22170817		1-	
C 2016	CHIP CAP.	0.047uF	50V	F	GRM40F473Z50PT	K22171008		1-	
C 2017	CHIP CAP.	0.01uF	50V	B	GRM40B103M50PT	K22170817		1-	
C 2018	CHIP CAP.	0.01uF	50V	B	GRM40B103M50PT	K22170817		1-	
C 2019	CHIP CAP.	100pF	50V	CH	GRM40CH101J50PT	K22170235		1-	
C 2020	AL.ELECTRO.CAP.	1uF	50V		50V010M4X7TR2	K46170030		1-	
C 2021	CHIP CAP.	0.047uF	50V	F	GRM40F473Z50PT	K22171008		1-	
C 2022	CHIP CAP.	0.047uF	50V	B	GRM40B473M50PT	K22170823		1-	
C 2023	AL.ELECTRO.CAP.	3.3uF	50V		50V3R3M4X7TR2	K46170032		1-	
C 2024	CHIP CAP.	220pF	50V	CH	GRM40CH221J50PT	K22170243		1-	
C 2025	CHIP CAP.	220pF	50V	CH	GRM40CH221J50PT	K22170243		1-	
C 2026	CHIP CAP.	0.22uF	16V	B	GRM40B224M16PT	K22120806		1-	
C 2027	CHIP CAP.	0.01uF	50V	B	GRM40B103M50PT	K22170817		1-	
C 2028	CHIP CAP.	0.01uF	50V	B	GRM40B103M50PT	K22170817		1-	
C 2029	CHIP CAP.	0.01uF	50V	B	GRM40B103M50PT	K22170817		1-	
C 2030	CHIP CAP.	0.01uF	50V	B	GRM40B103M50PT	K22170817		1-	
C 2031	CHIP CAP.	0.047uF	50V	F	GRM40F473Z50PT	K22171008		1-	
C 2032	AL.ELECTRO.CAP.	3.3uF	50V		50V3R3M4X7TR2	K46170032		1-	
C 2033	AL.ELECTRO.CAP.	10uF	16V		16V100M4X7TR2	K46120004		1-	
C 2034	CHIP CAP.	0.047uF	50V	F	GRM40F473Z50PT	K22171008		1-	
C 2035	CHIP CAP.	0.047uF	50V	F	GRM40F473Z50PT	K22171008		1-	
C 2036	CHIP CAP.	0.047uF	50V	F	GRM40F473Z50PT	K22171008		1-	
C 2037	CHIP CAP.	220pF	50V	CH	GRM40CH221J50PT	K22170243		1-	
C 2038	CHIP CAP.	0.047uF	50V	F	GRM40F473Z50PT	K22171008		1-	
C 2039	CHIP CAP.	0.001uF	50V	B	GRM40B102M50PT	K22170805		1-	
C 2040	CHIP CAP.	0.001uF	50V	B	GRM40B102M50PT	K22170805		1-	
C 2041	CHIP CAP.	220pF	50V	CH	GRM40CH221J50PT	K22170243		1-	
C 2042	CHIP CAP.	100pF	50V	CH	GRM40CH101J50PT	K22170235		1-	
C 2043	CHIP CAP.	5pF	50V	CH	GRM40CH050C50PT	K22170206		1-	
C 2044	CHIP CAP.	0.01uF	50V	B	GRM40B103M50PT	K22170817		1-	
C 2045	CHIP CAP.	0.01uF	50V	B	GRM40B103M50PT	K22170817		1-	
C 2046	CHIP CAP.	0.0018uF	50V	B	GRM40B182M50PT	K22170808		1-	
C 2047	CHIP CAP.	0.047uF	50V	F	GRM40F473Z50PT	K22171008		1-	
C 2049	CHIP CAP.	0.0018uF	50V	B	GRM40B182M50PT	K22170808		1-	
C 2050	CHIP CAP.	0.01uF	50V	B	GRM40B103M50PT	K22170817		1-	
C 2051	CHIP CAP.	0.047uF	50V	F	GRM40F473Z50PT	K22171008		1-	
C 2052	CHIP CAP.	47pF	50V	CH	GRM40CH470J50PT	K22170227		1-	
C 2053	CHIP CAP.	0.01uF	50V	B	GRM40B103M50PT	K22170817		1-	
C 2054	CHIP CAP.	0.01uF	50V	B	GRM40B103M50PT	K22170817		1-	
C 2055	CHIP CAP.	0.01uF	50V	B	GRM40B103M50PT	K22170817		1-	
C 2056	CHIP CAP.	0.047uF	50V	F	GRM40F473Z50PT	K22171008		1-	
C 2057	CHIP CAP.	0.01uF	50V	B	GRM40B103M50PT	K22170817		1-	
C 2058	CHIP CAP.	0.1uF	25V	F	GRM40F104Z25PT	K22141005		1-	
C 2059	CERAMIC CAP.	0.01uF	16V	Y	EP050Y103N-A	K28129001		1-	
C 2059	CHIP CAP.	0.01uF	50V	B	GRM40B103M50PT	K22170817		32-	
C 2060	CHIP CAP.	0.01uF	50V	B	GRM40B103M50PT	K22170817		1-	
C 2061	CHIP CAP.	10pF	50V	CH	GRM40CH100D50PT	K22170211		1-	
C 2062	CHIP CAP.	100pF	50V	CH	GRM40CH101J50PT	K22170235		1-	
C 2063	FILM CAP.	0.001uF	50V		ECQ-P1H102FZW	K55179007		1-	
C 2064	FILM CAP.	0.001uF	50V		ECQ-P1H102FZW	K55179007		1-	

REF.	DESCRIPTION	VALUE	V/W	TOL.	MFR'S DESIG	YAESU P/N	VERS.	LOT.	LAY ADR
C 2065	CHIP CAP.	0.01uF	50V	B	GRM40B103M50PT	K22170817		1-	
C 2066	CHIP CAP.	0.047uF	50V	F	GRM40F473Z50PT	K22171008		1-	
C 2067	CHIP CAP.	0.0018uF	50V	B	GRM40B182M50PT	K22170808		1-	
C 2068	CHIP CAP.	10pF	50V	CH	GRM40CH100D50PT	K22170211		1-	
C 2069	CHIP CAP.	0.01uF	50V	B	GRM40B103M50PT	K22170817		1-	
C 2070	CHIP CAP.	0.01uF	50V	B	GRM40B103M50PT	K22170817		1-	
C 2071	CHIP CAP.	0.0018uF	50V	B	GRM40B182M50PT	K22170808		1-	
C 2072	CHIP CAP.	10pF	50V	CH	GRM40CH100D50PT	K22170211		1-	
C 2073	CHIP CAP.	0.047uF	50V	F	GRM40F473Z50PT	K22171008		1-	
C 2074	CHIP CAP.	0.047uF	50V	F	GRM40F473Z50PT	K22171008		1-	
C 2075	CHIP CAP.	0.047uF	50V	F	GRM40F473Z50PT	K22171008		1-	
C 2076	CHIP CAP.	0.047uF	50V	F	GRM40F473Z50PT	K22171008		1-	
C 2077	CHIP CAP.	0.047uF	50V	F	GRM40F473Z50PT	K22171008		1-	
C 2078	CHIP CAP.	0.047uF	50V	F	GRM40F473Z50PT	K22171008		1-	
C 2079	CHIP CAP.	0.047uF	50V	F	GRM40F473Z50PT	K22171008		1-	
C 2080	CHIP CAP.	0.01uF	50V	B	GRM40B103M50PT	K22170817		1-	
C 2081	CHIP CAP.	0.01uF	50V	B	GRM40B103M50PT	K22170817		1-	
C 2082	CHIP CAP.	0.01uF	50V	B	GRM40B103M50PT	K22170817		1-	
C 2083	CHIP CAP.	0.01uF	50V	B	GRM40B103M50PT	K22170817		1-	
C 2084	CHIP CAP.	0.01uF	50V	B	GRM40B103M50PT	K22170817		1-	
C 2085	CHIP CAP.	10pF	50V	CH	GRM40CH100D50PT	K22170211		1-	
C 2086	CHIP CAP.	0.01uF	50V	B	GRM40B103M50PT	K22170817		1-	
C 2087	CHIP CAP.	0.047uF	50V	F	GRM40F473Z50PT	K22171008		1-	
C 2088	CHIP CAP.	0.01uF	50V	B	GRM40B103M50PT	K22170817		1-	
C 2089	CHIP CAP.	0.047uF	50V	F	GRM40F473Z50PT	K22171008		1-	
C 2090	CHIP CAP.	0.047uF	50V	F	GRM40F473Z50PT	K22171008		1-	
C 2091	CHIP CAP.	0.047uF	50V	F	GRM40F473Z50PT	K22171008		1-	
C 2092	CHIP CAP.	0.047uF	50V	F	GRM40F473Z50PT	K22171008		1-	
C 2093	CHIP CAP.	0.047uF	50V	F	GRM40F473Z50PT	K22171008		1-	
C 2094	CHIP CAP.	0.01uF	50V	B	GRM40B103M50PT	K22170817		1-	
C 2095	CHIP CAP.	470pF	50V	CH	GRM40CH471J50PT	K22170251		1-	
C 2096	CHIP CAP.	470pF	50V	CH	GRM40CH471J50PT	K22170251		1-	
C 2097	CHIP CAP.	0.01uF	50V	B	GRM40B103M50PT	K22170817		1-	
C 2098	CHIP CAP.	0.01uF	50V	B	GRM40B103M50PT	K22170817		1-	
C 2099	CHIP CAP.	0.01uF	50V	B	GRM40B103M50PT	K22170817		1-	
C 2100	CHIP CAP.	0.01uF	50V	B	GRM40B103M50PT	K22170817		1-	
C 2101	CHIP CAP.	10pF	50V	CH	GRM40CH100D50PT	K22170211		1-	
C 2102	CHIP CAP.	0.047uF	50V	F	GRM40F473Z50PT	K22171008		1-	
C 2103	CHIP CAP.	0.01uF	50V	B	GRM40B103M50PT	K22170817		1-	
C 2105	CHIP CAP.	0.047uF	50V	F	GRM40F473Z50PT	K22171008		1-	
C 2106	CHIP CAP.	0.047uF	50V	F	GRM40F473Z50PT	K22171008		1-	
C 2107	CHIP CAP.	0.047uF	50V	F	GRM40F473Z50PT	K22171008		1-	
C 2108	CHIP CAP.	0.01uF	50V	B	GRM40B103M50PT	K22170817		1-	
C 2109	CHIP CAP.	0.01uF	50V	B	GRM40B103M50PT	K22170817		1-	
C 2110	CHIP CAP.	0.01uF	50V	B	GRM40B103M50PT	K22170817		1-	
C 2111	CHIP CAP.	0.047uF	50V	F	GRM40F473Z50PT	K22171008		1-	
C 2112	CHIP CAP.	0.047uF	50V	F	GRM40F473Z50PT	K22171008		1-	
C 2114	CHIP CAP.	0.047uF	50V	F	GRM40F473Z50PT	K22171008		1-	
C 2115	CHIP CAP.	0.047uF	50V	F	GRM40F473Z50PT	K22171008		1-	
C 2116	CHIP CAP.	0.01uF	50V	B	GRM40B103M50PT	K22170817		1-	
C 2117	CHIP CAP.	0.01uF	50V	B	GRM40B103M50PT	K22170817		1-	
C 2118	CHIP CAP.	0.047uF	50V	F	GRM40F473Z50PT	K22171008		1-	
C 2119	CHIP CAP.	0.047uF	50V	F	GRM40F473Z50PT	K22171008		1-	
C 2120	CHIP CAP.	0.01uF	50V	B	GRM40B103M50PT	K22170817		1-	
C 2121	CHIP CAP.	0.01uF	50V	B	GRM40B103M50PT	K22170817		1-	
C 2122	CHIP CAP.	10pF	50V	CH	GRM40CH100D50PT	K22170211		1-	
C 2124	CHIP CAP.	0.01uF	50V	B	GRM40B103M50PT	K22170817		1-	
C 2125	CHIP CAP.	0.047uF	50V	F	GRM40F473Z50PT	K22171008		1-	
C 2126	CHIP CAP.	0.01uF	50V	B	GRM40B103M50PT	K22170817		1-	
C 2127	CHIP CAP.	0.01uF	50V	B	GRM40B103M50PT	K22170817		1-	
C 2129	CHIP CAP.	27pF	50V	CH	GRM40CH270J50PT	K22170221		1-	
C 2130	CHIP CAP.	0.047uF	50V	F	GRM40F473Z50PT	K22171008		1-	
C 2131	CHIP CAP.	0.001uF	50V	B	GRM40B102M50PT	K22170805		1-	
C 2133	CHIP CAP.	0.047uF	50V	F	GRM40F473Z50PT	K22171008		1-	
C 2134	CHIP CAP.	0.001uF	50V	B	GRM40B102M50PT	K22170805		1-	
C 2135	CHIP CAP.	0.01uF	50V	F	GRM40F103Z50PT	K22171004		1-	
C 2136	CHIP CAP.	0.01uF	50V	B	GRM40B103M50PT	K22170817		1-	
C 2137	CHIP CAP.	0.01uF	50V	B	GRM40B103M50PT	K22170817		1-	

IF Unit

Parts List

REF.	DESCRIPTION	VALUE	V/W	TOL.	MFR'S DESIG	YAESU P/N	VERS.	LOT.	LAY ADR
C 2138	CHIP CAP.	1pF	50V	CK	GRM40CK010C50PT	K22170202		1-	
C 2139	CHIP CAP.	0.01uF	50V	B	GRM40B103M50PT	K22170817		1-	
C 2140	CHIP CAP.	10pF	50V	CH	GRM40CH100D50PT	K22170211		1-	
C 2141	CHIP CAP.	0.047uF	50V	F	GRM40F473Z50PT	K22171008		1-	
C 2142	CHIP CAP.	0.047uF	50V	F	GRM40F473Z50PT	K22171008		1-	
C 2143	CHIP CAP.	0.047uF	50V	F	GRM40F473Z50PT	K22171008		1-	
C 2144	CHIP CAP.	0.047uF	50V	F	GRM40F473Z50PT	K22171008		1-	
C 2145	CHIP CAP.	0.01uF	50V	B	GRM40B103M50PT	K22170817		1-	
C 2146	CHIP CAP.	0.01uF	50V	B	GRM40B103M50PT	K22170817		1-	
C 2147	CHIP CAP.	0.047uF	50V	F	GRM40F473Z50PT	K22171008		1-	
C 2148	CHIP CAP.	0.047uF	50V	B	GRM40B473M50PT	K22170823		1-	
C 2149	CHIP CAP.	0.01uF	50V	B	GRM40B103M50PT	K22170817		1-	
C 2150	CHIP CAP.	0.01uF	50V	B	GRM40B103M50PT	K22170817		1-	
C 2151	CHIP CAP.	0.01uF	50V	B	GRM40B103M50PT	K22170817		1-	
C 2152	CHIP CAP.	0.001uF	50V	B	GRM40B102M50PT	K22170805		1-	
C 2153	CHIP CAP.	0.001uF	50V	B	GRM40B102M50PT	K22170805		1-	
C 2154	CHIP CAP.	0.01uF	50V	B	GRM40B103M50PT	K22170817		1-	
C 2155	AL.ELECTRO.CAP.	1uF	50V		50V010M4X7TR2	K46170030		1-	
C 2156	CHIP CAP.	0.01uF	50V	B	GRM40B103M50PT	K22170817		1-	
C 2157	CHIP CAP.	0.047uF	50V	F	GRM40F473Z50PT	K22171008		1-	
C 2158	AL.ELECTRO.CAP.	1uF	50V		50V010M4X7TR2	K46170030		1-	
C 2159	CHIP CAP.	0.01uF	50V	B	GRM40B103M50PT	K22170817		1-	
C 2160	CHIP CAP.	0.047uF	50V	F	GRM40F473Z50PT	K22171008		1-	
C 2161	CHIP CAP.	0.047uF	50V	F	GRM40F473Z50PT	K22171008		1-	
C 2162	CHIP CAP.	0.047uF	50V	F	GRM40F473Z50PT	K22171008		1-	
C 2163	CHIP CAP.	0.047uF	50V	F	GRM40F473Z50PT	K22171008		1-	
C 2164	CHIP CAP.	2pF	50V	CK	GRM40CK020C50PT	K22170203		1-	
C 2165	CHIP CAP.	0.047uF	50V	F	GRM40F473Z50PT	K22171008		1-	
C 2166	CHIP CAP.	0.047uF	50V	F	GRM40F473Z50PT	K22171008		1-	
C 2167	CHIP CAP.	0.047uF	50V	F	GRM40F473Z50PT	K22171008		1-	
C 2168	CHIP CAP.	0.01uF	50V	B	GRM40B103M50PT	K22170817		1-	
C 2169	CHIP CAP.	0.01uF	50V	B	GRM40B103M50PT	K22170817		1-	
C 2170	CHIP CAP.	0.01uF	50V	B	GRM40B103M50PT	K22170817		1-	
C 2171	CHIP CAP.	10pF	50V	CH	GRM40CH100D50PT	K22170211		1-	
C 2172	CHIP CAP.	0.01uF	50V	B	GRM40B103M50PT	K22170817		1-	
C 2173	CHIP CAP.	10pF	50V	CH	GRM40CH100D50PT	K22170211		1-	
C 2174	CHIP CAP.	0.01uF	50V	B	GRM40B103M50PT	K22170817		1-	
C 2175	CHIP CAP.	0.01uF	50V	B	GRM40B103M50PT	K22170817		1-	
C 2176	AL.ELECTRO.CAP.	22uF	16V		16V220M5X7TR2	K46120005		1-	
C 2177	CHIP CAP.	0.047uF	50V	F	GRM40F473Z50PT	K22171008		1-	
C 2178	CHIP CAP.	0.047uF	50V	F	GRM40F473Z50PT	K22171008		1-	
C 2179	CHIP CAP.	0.01uF	50V	B	GRM40B103M50PT	K22170817		1-	
C 2180	CHIP CAP.	0.001uF	50V	B	GRM40B102M50PT	K22170805		1-	
C 2181	CHIP CAP.	0.047uF	50V	F	GRM40F473Z50PT	K22171008		1-	
C 2182	CHIP CAP.	0.047uF	50V	F	GRM40F473Z50PT	K22171008		1-	
C 2183	AL.ELECTRO.CAP.	10uF	16V		16V100M4X7TR2	K46120004		1-	
C 2184	CHIP CAP.	22pF	50V	CH	GRM40CH220J50PT	K22170219		1-	
C 2185	CHIP CAP.	0.001uF	50V	B	GRM40B102M50PT	K22170805		1-	
C 2186	CHIP CAP.	0.01uF	50V	B	GRM40B103M50PT	K22170817		1-	
C 2187	CHIP CAP.	47pF	50V	CH	GRM40CH470J50PT	K22170227		1-	
C 2188	CHIP CAP.	47pF	50V	CH	GRM40CH470J50PT	K22170227		1-	
C 2189	CHIP CAP.	0.01uF	50V	B	GRM40B103M50PT	K22170817		1-	
C 2190	CHIP CAP.	3pF	50V	CJ	GRM40CJ030C50PT	K22170204		1-	
C 2191	CHIP CAP.	220pF	50V	CH	GRM40CH221J50PT	K22170243		1-	
C 2192	CHIP CAP.	0.01uF	50V	B	GRM40B103M50PT	K22170817		1-	
C 2193	CHIP CAP.	0.001uF	50V	B	GRM40B102M50PT	K22170805		1-	
C 2194	CHIP CAP.	0.001uF	50V	B	GRM40B102M50PT	K22170805		1-	
C 2195	CHIP CAP.	100pF	50V	CH	GRM40CH101J50PT	K22170235		1-	
C 2196	CHIP CAP.	0.01uF	50V	B	GRM40B103M50PT	K22170817		1-	
C 2197	CHIP CAP.	0.01uF	50V	B	GRM40B103M50PT	K22170817		1-	
C 2198	CHIP CAP.	0.1uF	25V	F	GRM40F104Z25PT	K22141005		1-	
C 2199	CHIP CAP.	0.0068uF	50V	B	GRM40B682M50PT	K22170815		1-	
C 2200	AL.ELECTRO.CAP.	1uF	50V		50V010M4X7TR2	K46170030		1-	
C 2201	CHIP CAP.	0.0047uF	50V	B	GRM40B472M50PT	K22170813		1-	
C 2202	AL.ELECTRO.CAP.	1uF	50V		50V010M4X7TR2	K46170030		1-	
C 2203	CHIP CAP.	0.047uF	50V	F	GRM40F473Z50PT	K22171008		1-	
C 2204	AL.ELECTRO.CAP.	22uF	6.3V		6V220M4X7TR2	K46080003		1-	
C 2205	CHIP CAP.	0.01uF	50V	B	GRM40B103M50PT	K22170817		1-	

REF.	DESCRIPTION	VALUE	V/W	TOL.	MFR'S DESIG	YAESU P/N	VERS.	LOT.	LAY ADR
C 2206	CHIP CAP.	0.0033uF	50V	B	GRM40B332M50PT	K22170811		1-	
C 2207	CHIP CAP.	0.01uF	50V	B	GRM40B103M50PT	K22170817		1-	
C 2208	CHIP CAP.	0.01uF	50V	B	GRM40B103M50PT	K22170817		1-	
C 2209	CHIP CAP.	150pF	50V	CH	GRM40CH151J50PT	K22170239		1-	
C 2210	CHIP CAP.	0.01uF	50V	B	GRM40B103M50PT	K22170817		1-	
C 2211	CHIP CAP.	0.1uF	25V	B	GRM40B104M25PT	K22140811		1-	
C 2212	CHIP CAP.	22pF	50V	CH	GRM40CH220J50PT	K22170219		1-	
C 2213	CHIP CAP.	22pF	50V	CH	GRM40CH220J50PT	K22170219		1-	
C 2214	CHIP CAP.	22pF	50V	CH	GRM40CH220J50PT	K22170219		1-	
C 2215	CHIP CAP.	22pF	50V	CH	GRM40CH220J50PT	K22170219		1-	
C 2216	CHIP CAP.	0.01uF	50V	B	GRM40B103M50PT	K22170817		1-	
C 2217	CHIP CAP.	1pF	50V	CK	GRM40CK010C50PT	K22170202		1-	
C 2218	CHIP CAP.	0.001uF	50V	B	GRM40B102M50PT	K22170805		1-	
C 2219	CHIP CAP.	0.01uF	50V	B	GRM40B103M50PT	K22170817		1-	
C 2220	CHIP CAP.	0.01uF	50V	B	GRM40B103M50PT	K22170817		1-	
C 2221	CHIP CAP.	0.1uF	25V	F	GRM40F104Z25PT	K22141005		1-	
C 2223	CHIP CAP.	22pF	50V	CH	GRM40CH220J50PT	K22170219		1-	
C 2224	CHIP CAP.	10pF	50V	CH	GRM40CH100D50PT	K22170211		1-	
C 2225	CHIP CAP.	0.047uF	50V	B	GRM40B473M50PT	K22170823		1-	
C 2226	CHIP CAP.	3pF	50V	CJ	GRM40CJ030C50PT	K22170204		1-	
C 2227	CHIP CAP.	3pF	50V	CJ	GRM40CJ030C50PT	K22170204		1-	
C 2228	CHIP CAP.	0.001uF	50V	B	GRM40B102M50PT	K22170805		1-	
C 2229	CHIP CAP.	0.001uF	50V	B	GRM40B102M50PT	K22170805		1-	
C 2230	CHIP CAP.	0.1uF	25V	F	GRM40F104Z25PT	K22141005		1-	
C 2231	AL.ELECTRO.CAP.	10uF	16V		16V100M4X7TR2	K46120004		1-	
C 2232	AL.ELECTRO.CAP.	10uF	16V		16V100M4X7TR2	K46120004		1-	
C 2235	TANTALUM CAP.	3.3uF	16V		DN1C3R3M1S	K70127335		1-	
C 2235	CHIP TA.CAP.	3.3uF	16V		TESVB21C335M8R	K78120010		32-	
C 2236	AL.ELECTRO.CAP.	220uF	16V		RE2-16V221M 220UF	K40129048		1-	
C 2237	TANTALUM CAP.	1uF	25V		TPDN1E010M8S(MX0)	K76140013		3-	
C 2237	CHIP TA.CAP.	1uF	16V		TESVA1C105M1-8R	K78120009		32-	
C 2238	CHIP CAP.	0.1uF	25V	B	GRM40B104M25PT	K22140811		32-	
C 2239	CHIP CAP.	100pF	50V	CH	GRM40CH101J50PT	K22170235		32-	
C 2240	CHIP CAP.	0.01uF	50V	B	GRM40B103M50PT	K22170817		32-	
C 2241	CHIP CAP.	0.1uF	25V	B	GRM40B104M25PT	K22140811		32-	
C 2242	CHIP CAP.	0.001uF	50V	B	GRM40B102M50PT	K22170805		32-	
C 2243	CHIP CAP.	0.001uF	50V	B	GRM40B102M50PT	K22170805		32-	
C 2244	CHIP CAP.	0.0047uF	50V	B	GRM40B472M50PT	K22170813		32-	
CD2001	CERAMIC DISC				CDB455C16	H7900740		1-	
CD2001	CERAMIC DISC				CDBM455C7	H7900480		32-	
CF2001	CERAMIC FILTER				CFWS455G	H3900507		1-	
CF2002	CERAMIC FILTER				CFWS455HT	H3900508		1-	
D 2001	DIODE				1SS270TJ	G2060004		1-	B2
D 2001	DIODE				1SS133 T-77	G2060001		27-	B2
D 2002	DIODE				1SS270TJ	G2060004		1-	B2
D 2002	DIODE				1SS133 T-77	G2060001		27-	B2
D 2003	DIODE				1SS270TJ	G2060004		1-	G1
D 2003	DIODE				1SS133 T-77	G2060001		27-	G1
D 2004	DIODE				1SS270TJ	G2060004		1-	B1
D 2004	DIODE				1SS133 T-77	G2060001		27-	B1
D 2005	DIODE				1SS270TJ	G2060004		1-	B1
D 2005	DIODE				1SS133 T-77	G2060001		27-	B1
D 2006	DIODE				1SS226 TE85R	G2070003		1-	g1
D 2007	DIODE				DAN202K T146	G2070182		1-	f1
D 2008	DIODE				1SS270TJ	G2060004		1-	B2
D 2008	DIODE				1SS133 T-77	G2060001		27-	B2
D 2009	DIODE				1SS270TJ	G2060004		1-	B1
D 2009	DIODE				1SS133 T-77	G2060001		27-	B1
D 2010	DIODE				1SS270TJ	G2060004		1-	C1
D 2010	DIODE				1SS133 T-77	G2060001		27-	C1
D 2011	DIODE				DAN202K T146	G2070182		1-	f1
D 2012	DIODE				1SS198TJ	G2060011		1-	G2
D 2013	DIODE				1SS198TJ	G2060011		1-	G2
D 2014	DIODE				1SS226 TE85R	G2070003		1-	g2
D 2015	DIODE				1SS226 TE85R	G2070003		1-	e2
D 2016	DIODE				1SS226 TE85R	G2070003		1-	a4
D 2017	DIODE				1SS226 TE85R	G2070003		1-	a4
D 2018	DIODE				1SS226 TE85R	G2070003		1-	d4

IF Unit

Parts List

REF.	DESCRIPTION	VALUE	V/W	TOL.	MFR'S DESIG	YAESU P/N	VERS.	LOT.	LAY ADR
D 2019	DIODE				1SS226 TE85R	G2070003		1-	f2
D 2020	DIODE				HVU306A5TRF	G2070132		1-	a3
D 2021	DIODE				1SS270TJ	G2060004		1-	A1
D 2021	DIODE				1SS133 T-77	G2060001		27-	A1
D 2022	DIODE				1SS226 TE85R	G2070003		1-	e3
D 2023	DIODE				DAN202K T146	G2070182		1-	e4
D 2024	DIODE				1SS226 TE85R	G2070003		1-	a4
D 2025	DIODE				1SS270TJ	G2060004		1-	D4
D 2025	DIODE				1SS133 T-77	G2060001		27-	D4
D 2026	DIODE				1SS226 TE85R	G2070003		1-	f3
D 2027	DIODE				1SS226 TE85R	G2070003		1-	c4
D 2028	DIODE				1SS226 TE85R	G2070003		1-	f3
D 2029	DIODE				DAP202K T146	G2070180		1-	a3
D 2030	DIODE				1SS226 TE85R	G2070003		1-	e3
D 2032	DIODE				1SS270TJ	G2060004		1-	D4
D 2032	DIODE				1SS133 T-77	G2060001		27-	D4
D 2033	DIODE				DAP202K T146	G2070180		1-	c2
D 2034	DIODE				DAP202K T146	G2070180		1-	f2
D 2035	DIODE				1SS226 TE85R	G2070003		1-	c2
D 2036	DIODE				1SS226 TE85R	G2070003		1-	e4
D 2037	DIODE				1SS270TJ	G2060004		1-	G1
D 2037	DIODE				1SS133 T-77	G2060001		27-	G1
D 2038	DIODE				1SS270TJ	G2060004		1-	D4
D 2038	DIODE				1SS133 T-77	G2060001		27-	D4
D 2039	DIODE				DAP202K T146	G2070180		1-	d2
D 2040	DIODE				DAP202K T146	G2070180		1-	d3
D 2041	DIODE				1SS226 TE85R	G2070003		1-	f2
D 2042	DIODE				1SS226 TE85R	G2070003		1-	e3
D 2043	DIODE				1SS270TJ	G2060004		1-	C3
D 2043	DIODE				1SS133 T-77	G2060001		27-	C3
D 2044	DIODE				1SV271 TPH3	G2070476		1-	d4
D 2045	DIODE				1SS198TJ	G2060011		1-	D2
D 2046	DIODE				1SS198TJ	G2060011		1-	D2
D 2047	DIODE				1SS270TJ	G2060004		1-	C4
D 2047	DIODE				1SS133 T-77	G2060001		27-	C4
D 2049	DIODE				HVU306A5TRF	G2070132		1-	d1
D 2050	DIODE				1SS226 TE85R	G2070003		1-	d1
D 2051	DIODE				1SS270TJ	G2060004		1-	G4
D 2051	DIODE				1SS133 T-77	G2060001		27-	G4
D 2052	DIODE				1SS226 TE85R	G2070003		1-	f4
D 2053	DIODE				1SS270TJ	G2060004		1-	D2
D 2053	DIODE				1SS133 T-77	G2060001		27-	D2
D 2055	DIODE				DAN202K T146	G2070182		1-	e1
D 2056	DIODE				DAN202K T146	G2070182		1-	d3
D 2057	DIODE				1SV271 TPH3	G2070476		1-	g3
D 2058	DIODE				1SV271 TPH3	G2070476		1-	a3
D 2059	DIODE				1SS270TJ	G2060004		1-	C1
D 2059	DIODE				1SS133 T-77	G2060001		27-	C1
D 2060	DIODE				1SS270TJ	G2060004		3-	G3
D 2060	DIODE				1SS133 T-77	G2060001		27-	G3
D 2061	DIODE				1SS270TJ	G2060004		3-	F2
D 2061	DIODE				1SS133 T-77	G2060001		27-	F2
D 2062	DIODE				02CZ5.1Y TE85R	G2070062		32-	e1
J 2002	CONNECTOR				SC25-02WS	P0090621		1-	
J 2003	CONNECTOR				TMP-J01X-A2	P1090255		1-	
J 2004	CONNECTOR				16FMZ-BT	P1090902		1-	
J 2005	CONNECTOR				TMP-J01X-A2	P1090255		1-	
J 2007	CONNECTOR				TMP-J01X-A2	P1090255		1-	
J 2008	CONNECTOR				TMP-J01X-A2	P1090255		1-	
J 2009	CONNECTOR				SC25-02WS	P0090621		1-	
J 2010	CONNECTOR				TMP-J01X-A2	P1090255		1-	
J 2011	CONNECTOR				SC25-02WS	P0090621		1-	
J 2012	CONNECTOR				SC25-02WS	P0090621		1-	
J 2013	CONNECTOR				20FMZ-BT	P1090903		1-	
J 2014	CONNECTOR				12FMZ-BT	P1090901		1-	
J 2015	CONNECTOR				3022-04B	P0090523		1-	
J 2016	CONNECTOR				3022-04B	P0090523		1-	
J 2017	CONNECTOR				3022-04B	P0090523		1-	

IF Unit

Parts List

REF.	DESCRIPTION	VALUE	V/W	TOL.	MFR'S DESIG	YAESU P/N	VERS.	LOT.	LAY ADR
J 2018	CONNECTOR				3022-04B	P0090523		1-	
J 2019	CONNECTOR				3022-04B	P0090523		1-	
J 2020	CONNECTOR				3022-04B	P0090523		1-	
J 2021	CONNECTOR				3022-04B	P0090523		1-	
J 2022	CONNECTOR				3022-04B	P0090523		1-	
J 2023	CONNECTOR				3022-04B	P0090523		1-	
J 2024	CONNECTOR				3022-04B	P0090523		1-	
J 2025	CONNECTOR				3022-04B	P0090523		1-	
J 2026	CONNECTOR				3022-04B	P0090523		1-	
JP2001	WIRE ASSY				A0243	T9206158		1-	
JP2003	WIRE ASSY				A0243	T9206159		1-	
L 2002	M.RFC	150uH			LAP02TA151K	L1790072		1-	
L 2004	COIL 07RF	455kHz			455K R12-E453A	L0021610		1-	
L 2005	M.RFC	150uH			LAP02TA151K	L1790072		1-	
L 2006	M.RFC	150uH			LAP02TA151K	L1790072		1-	
L 2007	M.RFC	150uH			LAP02TA151K	L1790072		1-	
L 2008	M.RFC	150uH			LAP02TA151K	L1790072		1-	
L 2009	M.RFC	150uH			LAP02TA151K	L1790072		1-	
L 2010	M.RFC	220uH			LAP02TA221K	L1790074		1-	
L 2011	M.RFC	150uH			LAP02TA151K	L1790072		1-	
L 2012	M.RFC	150uH			LAP02TA151K	L1790072		1-	
L 2013	M.RFC	150uH			LAP02TA151K	L1790072		1-	
L 2014	M.RFC	150uH			LAP02TA151K	L1790072		1-	
L 2016	M.RFC	220uH			LAP02TA221K	L1790074		1-	
L 2017	M.RFC	100uH			LAP02TA101K	L1790070		1-	
L 2018	M.RFC	220uH			LAP02TA221K	L1790074		1-	
L 2019	M.RFC	150uH			LAP02TA151K	L1790072		1-	
L 2020	M.RFC	220uH			LAP02TA221K	L1790074		1-	
L 2021	M.RFC	220uH			LAP02TA221K	L1790074		1-	
L 2022	M.RFC	220uH			LAP02TA221K	L1790074		1-	
L 2024	M.RFC	15uH			LAP02TA150K	L1790060		1-	
L 2025	M.RFC	100uH			LAP02TA101K	L1790070		1-	
L 2026	COIL 05RF				31U R12-G458X	L0021863		1-	
L 2029	M.RFC	220uH			LAP02TA221K	L1790074		1-	
Q 2001	TRANSISTOR				2SC2812L6-TA	G3328127F		1-	f1
Q 2001	TRANSISTOR				2SC2812NL6-TB	G3328128F		8-	f1
Q 2002	FET				2SK160-T2B K6	G3801607F		1-	f1
Q 2003	FET				2SK302GR TE85R	G3803027G		1-	f2
Q 2004	TRANSISTOR				2SC2812L6-TA	G3328127F		1-	a2
Q 2004	TRANSISTOR				2SC2812NL6-TB	G3328128F		8-	a2
Q 2005	TRANSISTOR				2SA1179M6-TA	G3111797F		1-	f1
Q 2006	TRANSISTOR				2SA1179M6-TA	G3111797F		1-	f1
Q 2007	IC				M5223AFP 600C	G1092955		1-	a1
Q 2008	TRANSISTOR				2SC2812L6-TA	G3328127F		1-	g1
Q 2008	TRANSISTOR				2SC2812NL6-TB	G3328128F		8-	g1
Q 2009	FET				3SK131-T2B V12	G4801317B		1-	g2
Q 2010	FET				3SK131-T2B V12	G4801317B		1-	g1
Q 2011	FET				2SK160-T2B K6	G3801607F		1-	a1
Q 2012	TRANSISTOR				2SC2812L6-TA	G3328127F		1-	f1
Q 2012	TRANSISTOR				2SC2812NL6-TB	G3328128F		8-	f1
Q 2013	TRANSISTOR				2SC2812L6-TA	G3328127F		1-	f1
Q 2013	TRANSISTOR				2SC2812NL6-TB	G3328128F		8-	f1
Q 2014	TRANSISTOR				2SC4047-TA	G3340477		1-	f1
Q 2014	TRANSISTOR				UN2214-(TX)	G3070206		8-	f1
Q 2015	IC				MC3372ML	G1091108		1-	e2
Q 2015	IC				TA31136F(TAPE)	G1093446		32-	e2
Q 2016	TRANSISTOR				2SC4047-TA	G3340477		1-	g2
Q 2016	TRANSISTOR				UN2214-(TX)	G3070206		8-	g2
Q 2017	TRANSISTOR				2SC2812L6-TA	G3328127F		1-	a2
Q 2017	TRANSISTOR				2SC2812NL6-TB	G3328128F		8-	a2
Q 2018	TRANSISTOR				2SC2812L6-TA	G3328127F		1-	a2
Q 2018	TRANSISTOR				2SC2812NL6-TB	G3328128F		8-	a2
Q 2019	TRANSISTOR				2SC4047-TA	G3340477		1-	a2
Q 2019	TRANSISTOR				UN2214-(TX)	G3070206		8-	a2
Q 2020	FET				2SK302GR TE85R	G3803027G		1-	g2
Q 2021	IC				UPC1037H	G1090101		1-	D4
Q 2022	TRANSISTOR				2SC2812L6-TA	G3328127F		1-	a4
Q 2022	TRANSISTOR				2SC2812NL6-TB	G3328128F		8-	a4

IF Unit

Parts List

REF.	DESCRIPTION	VALUE	V/W	TOL.	MFR'S DESIG	YAESU P/N	VERS.	LOT.	LAY ADR
Q 2023	TRANSISTOR				2SC2812L6-TA	G3328127F		1-	a3
Q 2023	TRANSISTOR				2SC2812NL6-TB	G3328128F		8-	a3
Q 2024	FET				2SK302GR TE85R	G3803027G		1-	g2
Q 2025	TRANSISTOR				2SC2812L6-TA	G3328127F		1-	a4
Q 2025	TRANSISTOR				2SC2812NL6-TB	G3328128F		8-	a4
Q 2026	FET				3SK131-T2B V12	G4801317B		1-	a3
Q 2027	TRANSISTOR				2SC2812L6-TA	G3328127F		1-	g3
Q 2027	TRANSISTOR				2SC2812NL6-TB	G3328128F		8-	g3
Q 2028	TRANSISTOR				2SC2812L6-TA	G3328127F		1-	d2
Q 2028	TRANSISTOR				2SC2812NL6-TB	G3328128F		8-	d2
Q 2029	FET				3SK131-T2B V12	G4801317B		1-	a3
Q 2030	IC				UPC1037H	G1090101		1-	D4
Q 2031	IC				X9313WS	G1091809		1-	a2
Q 2033	FET				2SK302GR TE85R	G3803027G		1-	g4
Q 2034	IC				TA7302P	G1090413		1-	D4
Q 2035	FET				3SK131-T2B V12	G4801317B		1-	d2
Q 2036	FET				3SK131-T2B V12	G4801317B		1-	g3
Q 2037	FET				2SK160-T2B K6	G3801607F		1-	d2
Q 2038	FET				2SK302GR TE85R	G3803027G		1-	f4
Q 2039	TRANSISTOR				2SC4047-TA	G3340477		1-	e3
Q 2039	TRANSISTOR				UN2214-(TX)	G3070206		8-	e3
Q 2040	TRANSISTOR				2SC4047-TA	G3340477		1-	e3
Q 2040	TRANSISTOR				UN2214-(TX)	G3070206		8-	e3
Q 2041	FET				2SK160-T2B K6	G3801607F		1-	d2
Q 2042	TRANSISTOR				2SC2812L6-TA	G3328127F		1-	d2
Q 2042	TRANSISTOR				2SC2812NL6-TB	G3328128F		8-	d2
Q 2043	TRANSISTOR				2SC2812L6-TA	G3328127F		1-	d1
Q 2043	TRANSISTOR				2SC2812NL6-TB	G3328128F		8-	d1
Q 2044	TRANSISTOR				2SC2812L6-TA	G3328127F		1-	d1
Q 2044	TRANSISTOR				2SC2812NL6-TB	G3328128F		8-	d1
Q 2045	TRANSISTOR				2SA1563-TB	G3115638		1-	c1
Q 2046	TRANSISTOR				2SC4047-TA	G3340477		1-	d1
Q 2046	TRANSISTOR				UN2214-(TX)	G3070206		8-	d1
Q 2047	TRANSISTOR				2SC4047-TA	G3340477		1-	c1
Q 2047	TRANSISTOR				UN2214-(TX)	G3070206		8-	c1
Q 2048	TRANSISTOR				2SC4047-TA	G3340477		1-	b2
Q 2048	TRANSISTOR				UN2214-(TX)	G3070206		8-	b2
Q 2049	IC				M5223AFP 600C	G1092955		1-	c1
Q 2051	TRANSISTOR				2SA1563-TB	G3115638		1-	e1
Q 2052	TRANSISTOR				BA1A4P-T	G3050003		3-	
Q 2052	TRANSISTOR				FA1A4P-T2B	G3070006		32-	b2
Q 2053	TRANSISTOR				FA1A4P-T2B	G3070006		32-	e2
R 2001	CHIP RES.	4.7k	1/10W	5%	RMC1/10T 472J	J24205472		1-	
R 2002	CHIP RES.	33k	1/10W	5%	RMC1/10T 333J	J24205333		1-	
R 2003	CHIP RES.	100k	1/10W	5%	RMC1/10T 104J	J24205104		1-	
R 2004	CHIP RES.	100	1/10W	5%	RMC1/10T 101J	J24205101		1-	
R 2006	CHIP RES.	330k	1/10W	5%	RMC1/10T 334J	J24205334		1-	
R 2007	CHIP RES.	100k	1/10W	5%	RMC1/10T 104J	J24205104		1-	
R 2008	CHIP RES.	100k	1/10W	5%	RMC1/10T 104J	J24205104		1-	
R 2009	CHIP RES.	100k	1/10W	5%	RMC1/10T 104J	J24205104		1-	
R 2010	CHIP RES.	1k	1/10W	5%	RMC1/10T 102J	J24205102		1-	
R 2011	CHIP RES.	470k	1/10W	5%	RMC1/10T 474J	J24205474		1-	
R 2012	CHIP RES.	1.5k	1/10W	5%	RMC1/10T 152J	J24205152		1-	
R 2013	CHIP RES.	1.5k	1/10W	5%	RMC1/10T 152J	J24205152		1-	
R 2014	CHIP RES.	1k	1/10W	5%	RMC1/10T 102J	J24205102		1-	
R 2015	CHIP RES.	100	1/10W	5%	RMC1/10T 101J	J24205101		1-	
R 2016	CHIP RES.	150k	1/10W	5%	RMC1/10T 154J	J24205154		1-	
R 2017	CHIP RES.	2.2k	1/10W	5%	RMC1/10T 222J	J24205222		1-	
R 2019	CHIP RES.	1k	1/10W	5%	RMC1/10T 102J	J24205102		1-	
R 2020	CHIP RES.	100k	1/10W	5%	RMC1/10T 104J	J24205104		1-	
R 2021	CHIP RES.	1k	1/10W	5%	RMC1/10T 102J	J24205102		1-	
R 2022	CHIP RES.	39k	1/10W	5%	RMC1/10T 393J	J24205393		1-	
R 2023	CHIP RES.	100k	1/10W	5%	RMC1/10T 104J	J24205104		1-	
R 2024	CHIP RES.	1k	1/10W	5%	RMC1/10T 102J	J24205102		1-	
R 2025	CHIP RES.	10k	1/10W	5%	RMC1/10T 103J	J24205103		1-	
R 2026	CHIP RES.	15k	1/10W	5%	RMC1/10T 153J	J24205153		1-	
R 2027	CHIP RES.	15k	1/10W	5%	RMC1/10T 153J	J24205153		1-	
R 2028	CHIP RES.	3.3k	1/10W	5%	RMC1/10T 332J	J24205332		1-	

IF Unit

Parts List

REF.	DESCRIPTION	VALUE	V/W	TOL.	MFR'S DESIG	YAESU P/N	VERS.	LOT.	LAYADR
R 2029	CHIP RES.	15k	1/10W	5%	RMC1/10T 153J	J24205153		1-	
R 2030	CHIP RES.	10k	1/10W	5%	RMC1/10T 103J	J24205103		1-	
R 2031	CHIP RES.	10k	1/10W	5%	RMC1/10T 103J	J24205103		1-	
R 2032	CHIP RES.	1k	1/10W	5%	RMC1/10T 102J	J24205102		1-	
R 2033	CHIP RES.	1k	1/10W	5%	RMC1/10T 102J	J24205102		1-	
R 2034	CHIP RES.	100	1/10W	5%	RMC1/10T 101J	J24205101		1-	
R 2035	CHIP RES.	330	1/10W	5%	RMC1/10T 331J	J24205331		1-	
R 2036	CHIP RES.	10k	1/10W	5%	RMC1/10T 103J	J24205103		1-	
R 2037	CHIP RES.	10k	1/10W	5%	RMC1/10T 103J	J24205103		1-	
R 2038	CHIP RES.	1M	1/10W	5%	RMC1/10T 105J	J24205105		1-	
R 2039	CHIP RES.	10k	1/10W	5%	RMC1/10T 103J	J24205103		1-	
R 2040	CHIP RES.	150k	1/10W	5%	RMC1/10T 154J	J24205154		1-	
R 2041	CHIP RES.	1k	1/10W	5%	RMC1/10T 102J	J24205102		1-	
R 2042	CHIP RES.	10k	1/10W	5%	RMC1/10T 103J	J24205103		1-	
R 2043	CHIP RES.	100	1/10W	5%	RMC1/10T 101J	J24205101		1-	
R 2044	CHIP RES.	22k	1/10W	5%	RMC1/10T 223J	J24205223		1-	
R 2045	CHIP RES.	33k	1/10W	5%	RMC1/10T 333J	J24205333		1-	
R 2046	CHIP RES.	220	1/10W	5%	RMC1/10T 221J	J24205221		1-	
R 2047	CHIP RES.	33k	1/10W	5%	RMC1/10T 333J	J24205333		1-	
R 2048	CHIP RES.	100	1/10W	5%	RMC1/10T 101J	J24205101		1-	
R 2049	CHIP RES.	220	1/10W	5%	RMC1/10T 221J	J24205221		1-	
R 2050	CHIP RES.	100	1/10W	5%	RMC1/10T 101J	J24205101		1-	
R 2051	CHIP RES.	100	1/10W	5%	RMC1/10T 101J	J24205101		1-	
R 2052	CHIP RES.	2.2k	1/10W	5%	RMC1/10T 222J	J24205222		1-	
R 2053	CHIP RES.	10k	1/10W	5%	RMC1/10T 103J	J24205103		1-	
R 2054	CHIP RES.	100k	1/10W	5%	RMC1/10T 104J	J24205104		1-	
R 2055	CHIP RES.	10	1/10W	5%	RMC1/10T 100J	J24205100		1-	
R 2056	CHIP RES.	100k	1/10W	5%	RMC1/10T 104J	J24205104		1-	
R 2057	CHIP RES.	10k	1/10W	5%	RMC1/10T 103J	J24205103		1-	
R 2058	CHIP RES.	47k	1/10W	5%	RMC1/10T 473J	J24205473		1-	
R 2059	CHIP RES.	10k	1/10W	5%	RMC1/10T 103J	J24205103		1-	
R 2060	CHIP RES.	0	1/10W	5%	RMC1/10T 000J	J24205000		1-	
R 2061	CHIP RES.	100	1/10W	5%	RMC1/10T 101J	J24205101		1-	
R 2062	CHIP RES.	1k	1/10W	5%	RMC1/10T 102J	J24205102		1-	
R 2063	CHIP RES.	470	1/10W	5%	RMC1/10T 471J	J24205471		1-	
R 2065	CHIP RES.	330k	1/10W	5%	RMC1/10T 334J	J24205334		1-	
R 2066	CHIP RES.	1k	1/10W	5%	RMC1/10T 102J	J24205102		1-	
R 2067	CHIP RES.	0	1/10W	5%	RMC1/10T 000J	J24205000		1-	
R 2069	CHIP RES.	100k	1/10W	5%	RMC1/10T 104J	J24205104		1-	
R 2070	CHIP RES.	100	1/10W	5%	RMC1/10T 101J	J24205101		1-	
R 2071	CHIP RES.	100	1/10W	5%	RMC1/10T 101J	J24205101		1-	
R 2072	CHIP RES.	4.7k	1/10W	5%	RMC1/10T 472J	J24205472		1-	
R 2073	CHIP RES.	4.7k	1/10W	5%	RMC1/10T 472J	J24205472		1-	
R 2074	CHIP RES.	330k	1/10W	5%	RMC1/10T 334J	J24205334		1-	
R 2075	CHIP RES.	100k	1/10W	5%	RMC1/10T 104J	J24205104		1-	
R 2076	CHIP RES.	3.3k	1/10W	5%	RMC1/10T 332J	J24205332		1-	
R 2077	CHIP RES.	100	1/10W	5%	RMC1/10T 101J	J24205101		1-	
R 2078	CHIP RES.	100	1/10W	5%	RMC1/10T 101J	J24205101		1-	
R 2079	CHIP RES.	100	1/10W	5%	RMC1/10T 101J	J24205101		1-	
R 2080	CHIP RES.	100	1/10W	5%	RMC1/10T 101J	J24205101		1-	
R 2081	CHIP RES.	100k	1/10W	5%	RMC1/10T 104J	J24205104		1-	
R 2082	CHIP RES.	82k	1/10W	5%	RMC1/10T 823J	J24205823		1-	
R 2083	CHIP RES.	1k	1/10W	5%	RMC1/10T 102J	J24205102		1-	
R 2084	CHIP RES.	1k	1/10W	5%	RMC1/10T 102J	J24205102		1-	
R 2085	CHIP RES.	100k	1/10W	5%	RMC1/10T 104J	J24205104		1-	
R 2086	CHIP RES.	8.2k	1/10W	5%	RMC1/10T 822J	J24205822		1-	
R 2087	CHIP RES.	1k	1/10W	5%	RMC1/10T 102J	J24205102		1-	
R 2088	CHIP RES.	100k	1/10W	5%	RMC1/10T 104J	J24205104		1-	
R 2089	CHIP RES.	1k	1/10W	5%	RMC1/10T 102J	J24205102		1-	
R 2090	CHIP RES.	470	1/10W	5%	RMC1/10T 471J	J24205471		1-	
R 2092	CHIP RES.	470	1/10W	5%	RMC1/10T 471J	J24205471		1-	
R 2093	CHIP RES.	560	1/10W	5%	RMC1/10T 561J	J24205561		1-	
R 2094	CHIP RES.	2.2k	1/10W	5%	RMC1/10T 222J	J24205222		1-	
R 2095	CHIP RES.	4.7k	1/10W	5%	RMC1/10T 472J	J24205472		1-	
R 2096	CHIP RES.	82	1/10W	5%	RMC1/10T 820J	J24205820		1-	
R 2097	CHIP RES.	82	1/10W	5%	RMC1/10T 820J	J24205820		1-	
R 2098	CHIP RES.	1k	1/10W	5%	RMC1/10T 102J	J24205102		1-	
R 2099	CHIP RES.	100	1/10W	5%	RMC1/10T 101J	J24205101		1-	

IF Unit

Parts List

REF.	DESCRIPTION	VALUE	V/W	TOL.	MFR'S DESIG	YAESU P/N	VERS.	LOT.	LAY ADR
R 2100	CHIP RES.	100k	1/10W	5%	RMC1/10T 104J	J24205104		1-	
R 2101	CHIP RES.	2.2k	1/10W	5%	RMC1/10T 222J	J24205222		1-	
R 2102	CHIP RES.	1.5k	1/10W	5%	RMC1/10T 152J	J24205152		1-	
R 2103	CHIP RES.	4.7k	1/10W	5%	RMC1/10T 472J	J24205472		1-	
R 2104	CHIP RES.	4.7k	1/10W	5%	RMC1/10T 472J	J24205472		1-	
R 2105	CHIP RES.	0	1/10W	5%	RMC1/10T 000J	J24205000		1-	
R 2106	CHIP RES.	0	1/10W	5%	RMC1/10T 000J	J24205000		1-	
R 2107	CHIP RES.	1k	1/10W	5%	RMC1/10T 102J	J24205102		1-	
R 2108	CHIP RES.	100	1/10W	5%	RMC1/10T 101J	J24205101		1-	
R 2109	CHIP RES.	100	1/10W	5%	RMC1/10T 101J	J24205101		1-	
R 2110	CHIP RES.	100	1/10W	5%	RMC1/10T 101J	J24205101		1-	
R 2111	CHIP RES.	100	1/10W	5%	RMC1/10T 101J	J24205101		1-	
R 2112	CHIP RES.	100	1/10W	5%	RMC1/10T 101J	J24205101		1-	
R 2113	CHIP RES.	100	1/10W	5%	RMC1/10T 101J	J24205101		1-	
R 2114	CHIP RES.	100k	1/10W	5%	RMC1/10T 104J	J24205104		1-	
R 2115	CHIP RES.	100	1/10W	5%	RMC1/10T 101J	J24205101		1-	
R 2117	CHIP RES.	10k	1/10W	5%	RMC1/10T 103J	J24205103		1-	
R 2118	CHIP RES.	1k	1/10W	5%	RMC1/10T 102J	J24205102		1-	
R 2119	CHIP RES.	100	1/10W	5%	RMC1/10T 101J	J24205101		1-	
R 2120	CHIP RES.	1k	1/10W	5%	RMC1/10T 102J	J24205102		1-	
R 2121	CHIP RES.	10k	1/10W	5%	RMC1/10T 103J	J24205103		1-	
R 2123	CHIP RES.	15k	1/10W	5%	RMC1/10T 153J	J24205153		1-	
R 2124	CHIP RES.	10k	1/10W	5%	RMC1/10T 103J	J24205103		1-	
R 2125	CHIP RES.	150	1/10W	5%	RMC1/10T 151J	J24205151		1-	
R 2126	CHIP RES.	150	1/10W	5%	RMC1/10T 151J	J24205151		1-	
R 2127	CHIP RES.	150	1/10W	5%	RMC1/10T 151J	J24205151		1-	
R 2128	CHIP RES.	150	1/10W	5%	RMC1/10T 151J	J24205151		1-	
R 2129	CHIP RES.	10k	1/10W	5%	RMC1/10T 103J	J24205103		1-	
R 2130	CHIP RES.	22k	1/10W	5%	RMC1/10T 223J	J24205223		1-	
R 2131	CHIP RES.	4.7k	1/10W	5%	RMC1/10T 472J	J24205472		1-	
R 2132	CHIP RES.	4.7k	1/10W	5%	RMC1/10T 472J	J24205472		1-	
R 2133	CHIP RES.	100	1/10W	5%	RMC1/10T 101J	J24205101		1-	
R 2134	CHIP RES.	470	1/10W	5%	RMC1/10T 471J	J24205471		1-	
R 2135	CHIP RES.	680	1/10W	5%	RMC1/10T 681J	J24205681		1-	
R 2136	CHIP RES.	680	1/10W	5%	RMC1/10T 681J	J24205681		1-	
R 2137	CHIP RES.	1k	1/10W	5%	RMC1/10T 102J	J24205102		1-	
R 2138	CHIP RES.	100	1/10W	5%	RMC1/10T 101J	J24205101		1-	
R 2139	CHIP RES.	100	1/10W	5%	RMC1/10T 101J	J24205101		1-	
R 2140	CHIP RES.	15k	1/10W	5%	RMC1/10T 153J	J24205153		1-	
R 2141	CHIP RES.	470	1/10W	5%	RMC1/10T 471J	J24205471		1-	
R 2142	CHIP RES.	56k	1/10W	5%	RMC1/10T 563J	J24205563		1-	
R 2143	CHIP RES.	100	1/10W	5%	RMC1/10T 101J	J24205101		1-	
R 2145	CHIP RES.	1k	1/10W	5%	RMC1/10T 102J	J24205102		1-	
R 2146	CHIP RES.	100	1/10W	5%	RMC1/10T 101J	J24205101		1-	
R 2148	CHIP RES.	33k	1/10W	5%	RMC1/10T 333J	J24205333		1-	
R 2149	CHIP RES.	100	1/10W	5%	RMC1/10T 101J	J24205101		1-	
R 2150	CHIP RES.	100	1/10W	5%	RMC1/10T 101J	J24205101		1-	
R 2151	CHIP RES.	100	1/10W	5%	RMC1/10T 101J	J24205101		1-	
R 2152	CHIP RES.	100	1/10W	5%	RMC1/10T 101J	J24205101		1-	
R 2153	CHIP RES.	4.7k	1/10W	5%	RMC1/10T 472J	J24205472		1-	
R 2154	CHIP RES.	4.7k	1/10W	5%	RMC1/10T 472J	J24205472		1-	
R 2155	CHIP RES.	15k	1/10W	5%	RMC1/10T 153J	J24205153		1-	
R 2157	CHIP RES.	150	1/10W	5%	RMC1/10T 151J	J24205151		1-	
R 2158	CHIP RES.	150	1/10W	5%	RMC1/10T 151J	J24205151		1-	
R 2159	CHIP RES.	100	1/10W	5%	RMC1/10T 101J	J24205101		1-	
R 2160	CHIP RES.	100	1/10W	5%	RMC1/10T 101J	J24205101		1-	
R 2161	CHIP RES.	680	1/10W	5%	RMC1/10T 681J	J24205681		1-	
R 2163	CHIP RES.	10k	1/10W	5%	RMC1/10T 103J	J24205103		1-	
R 2165	CHIP RES.	100	1/10W	5%	RMC1/10T 101J	J24205101		1-	
R 2166	CHIP RES.	100	1/10W	5%	RMC1/10T 101J	J24205101		1-	
R 2167	CHIP RES.	1k	1/10W	5%	RMC1/10T 102J	J24205102		1-	
R 2168	CHIP RES.	1k	1/10W	5%	RMC1/10T 102J	J24205102		1-	
R 2169	CHIP RES.	100	1/10W	5%	RMC1/10T 101J	J24205101		1-	
R 2170	CHIP RES.	4.7k	1/10W	5%	RMC1/10T 472J	J24205472		1-	
R 2171	CHIP RES.	4.7k	1/10W	5%	RMC1/10T 472J	J24205472		1-	
R 2172	CHIP RES.	4.7k	1/10W	5%	RMC1/10T 472J	J24205472		1-	
R 2173	CHIP RES.	4.7k	1/10W	5%	RMC1/10T 472J	J24205472		1-	
R 2174	CHIP RES.	220	1/10W	5%	RMC1/10T 221J	J24205221		1-	

REF.	DESCRIPTION	VALUE	V/W	TOL.	MFR'S DESIG	YAESU P/N	VERS.	LOT.	LAY ADR
R 2175	CHIP RES.	220	1/10W	5%	RMC1/10T 221J	J24205221		1-	
R 2176	CHIP RES.	100	1/10W	5%	RMC1/10T 101J	J24205101		1-	
R 2177	CHIP RES.	100	1/10W	5%	RMC1/10T 101J	J24205101		1-	
R 2178	CHIP RES.	220	1/10W	5%	RMC1/10T 221J	J24205221		1-	
R 2179	CHIP RES.	2.2k	1/10W	5%	RMC1/10T 222J	J24205222		1-	
R 2180	CHIP RES.	100	1/10W	5%	RMC1/10T 101J	J24205101		1-	
R 2181	CHIP RES.	2.2k	1/10W	5%	RMC1/10T 222J	J24205222		1-	
R 2182	CHIP RES.	100	1/10W	5%	RMC1/10T 101J	J24205101		1-	
R 2183	CHIP RES.	470	1/10W	5%	RMC1/10T 471J	J24205471		1-	
R 2185	CHIP RES.	100	1/10W	5%	RMC1/10T 101J	J24205101		1-	
R 2186	CHIP RES.	100	1/10W	5%	RMC1/10T 101J	J24205101		1-	
R 2187	CHIP RES.	47k	1/10W	5%	RMC1/10T 473J	J24205473		1-	
R 2188	CHIP RES.	10k	1/10W	5%	RMC1/10T 103J	J24205103		1-	
R 2189	CHIP RES.	100	1/10W	5%	RMC1/10T 101J	J24205101		1-	
R 2190	CHIP RES.	680	1/10W	5%	RMC1/10T 681J	J24205681		1-	
R 2191	CHIP RES.	680	1/10W	5%	RMC1/10T 681J	J24205681		1-	
R 2192	CHIP RES.	100k	1/10W	5%	RMC1/10T 104J	J24205104		1-	
R 2193	CHIP RES.	100	1/10W	5%	RMC1/10T 101J	J24205101		1-	
R 2194	CHIP RES.	10k	1/10W	5%	RMC1/10T 103J	J24205103		1-	
R 2195	CHIP RES.	22k	1/10W	5%	RMC1/10T 223J	J24205223		1-	
R 2196	CHIP RES.	10k	1/10W	5%	RMC1/10T 103J	J24205103		1-	
R 2198	CHIP RES.	1k	1/10W	5%	RMC1/10T 102J	J24205102		1-	
R 2199	CHIP RES.	100k	1/10W	5%	RMC1/10T 104J	J24205104		1-	
R 2200	CHIP RES.	100k	1/10W	5%	RMC1/10T 104J	J24205104		1-	
R 2201	CHIP RES.	56k	1/10W	5%	RMC1/10T 563J	J24205563		1-	
R 2202	CHIP RES.	18k	1/10W	5%	RMC1/10T 183J	J24205183		1-	
R 2204	CHIP RES.	100	1/10W	5%	RMC1/10T 101J	J24205101		1-	
R 2205	CHIP RES.	1k	1/10W	5%	RMC1/10T 102J	J24205102		1-	
R 2206	CHIP RES.	47k	1/10W	5%	RMC1/10T 473J	J24205473		1-	
R 2208	CHIP RES.	220	1/10W	5%	RMC1/10T 221J	J24205221		1-	
R 2209	CHIP RES.	470	1/10W	5%	RMC1/10T 471J	J24205471		1-	
R 2210	CHIP RES.	220	1/10W	5%	RMC1/10T 221J	J24205221		1-	
R 2211	CHIP RES.	220	1/10W	5%	RMC1/10T 221J	J24205221		1-	
R 2212	CHIP RES.	1k	1/10W	5%	RMC1/10T 102J	J24205102		1-	
R 2213	CHIP RES.	1.5k	1/10W	5%	RMC1/10T 152J	J24205152		1-	
R 2214	CHIP RES.	2.2k	1/10W	5%	RMC1/10T 222J	J24205222		1-	
R 2215	CHIP RES.	150	1/10W	5%	RMC1/10T 151J	J24205151		1-	
R 2216	CHIP RES.	100k	1/10W	5%	RMC1/10T 104J	J24205104		1-	
R 2217	CHIP RES.	33k	1/10W	5%	RMC1/10T 333J	J24205333		1-	
R 2218	CHIP RES.	100k	1/10W	5%	RMC1/10T 104J	J24205104		1-	
R 2219	CHIP RES.	470	1/10W	5%	RMC1/10T 471J	J24205471		1-	
R 2220	CHIP RES.	470	1/10W	5%	RMC1/10T 471J	J24205471		1-	
R 2221	CHIP RES.	10k	1/10W	5%	RMC1/10T 103J	J24205103		1-	
R 2222	CHIP RES.	4.7k	1/10W	5%	RMC1/10T 472J	J24205472		1-	
R 2223	CHIP RES.	10k	1/10W	5%	RMC1/10T 103J	J24205103		1-	
R 2224	CHIP RES.	4.7k	1/10W	5%	RMC1/10T 472J	J24205472		1-	
R 2225	CHIP RES.	3.3M	1/10W	5%	RMC1/10T 335J	J24205335		1-	
R 2226	CHIP RES.	1M	1/10W	5%	RMC1/10T 105J	J24205105		1-	
R 2227	CHIP RES.	4.7k	1/10W	5%	RMC1/10T 472J	J24205472		1-	
R 2228	CHIP RES.	4.7k	1/10W	5%	RMC1/10T 472J	J24205472		1-	
R 2229	CHIP RES.	12k	1/10W	5%	RMC1/10T 123J	J24205123		1-	
R 2230	CHIP RES.	12k	1/10W	5%	RMC1/10T 123J	J24205123		1-	
R 2231	CHIP RES.	1k	1/10W	5%	RMC1/10T 102J	J24205102		1-	
R 2233	CHIP RES.	1M	1/10W	5%	RMC1/10T 105J	J24205105		1-	
R 2235	CHIP RES.	47k	1/10W	5%	RMC1/10T 473J	J24205473		1-	
R 2236	CHIP RES.	3.3k	1/10W	5%	RMC1/10T 332J	J24205332		1-	
R 2237	CHIP RES.	68	1/10W	5%	RMC1/10T 680J	J24205680		1-	
R 2238	CHIP RES.	56k	1/10W	5%	RMC1/10T 563J	J24205563		1-	
R 2239	CHIP RES.	2.2k	1/10W	5%	RMC1/10T 222J	J24205222		1-	
R 2241	CHIP RES.	1k	1/10W	5%	RMC1/10T 102J	J24205102		1-	
R 2242	CHIP RES.	0	1/10W	5%	RMC1/10T 000J	J24205000		1-	
R 2243	CHIP RES.	0	1/10W	5%	RMC1/10T 000J	J24205000		1-	
R 2244	CHIP RES.	100	1/10W	5%	RMC1/10T 101J	J24205101		1-	
R 2245	CARBON FILM RES.	1.5k	1/6W	5%	RD16TPJ152 1.5K	J07225152		1-	
R 2248	CHIP RES.	150k	1/10W	5%	RMC1/10T 154J	J24205154		1-	
R 2249	CHIP RES.	1k	1/10W	5%	RMC1/10T 102J	J24205102		1-	
R 2250	CHIP RES.	3.3k	1/10W	5%	RMC1/10T 332J	J24205332		1-	
R 2252	CHIP RES.	10k	1/10W	5%	RMC1/10T 103J	J24205103		1-	

IF Unit

Parts List

REF.	DESCRIPTION	VALUE	V/W	TOL.	MFR'S DESIG	YAESU P/N	VERS.	LOT.	LAY ADR
R 2253	CHIP RES.	220	1/10W	5%	RMC1/10T 221J	J24205221		1-	
R 2254	CHIP RES.	22	1/10W	5%	RMC1/10T 220J	J24205220		1-	
R 2255	CHIP RES.	2.2k	1/10W	5%	RMC1/10T 222J	J24205222		1-	
R 2256	CHIP RES.	22k	1/10W	5%	RMC1/10T 223J	J24205223		1-	
R 2257	CHIP RES.	22k	1/10W	5%	RMC1/10T 223J	J24205223		1-	
R 2258	CHIP RES.	22k	1/10W	5%	RMC1/10T 223J	J24205223		1-	
R 2259	CHIP RES.	22k	1/10W	5%	RMC1/10T 223J	J24205223		1-	
R 2260	CHIP RES.	22k	1/10W	5%	RMC1/10T 223J	J24205223		1-	
R 2261	CHIP RES.	22k	1/10W	5%	RMC1/10T 223J	J24205223		1-	
R 2262	CHIP RES.	22k	1/10W	5%	RMC1/10T 223J	J24205223		1-	
R 2263	CHIP RES.	22k	1/10W	5%	RMC1/10T 223J	J24205223		1-	
R 2264	CHIP RES.	22k	1/10W	5%	RMC1/10T 223J	J24205223		1-	
R 2265	CHIP RES.	22k	1/10W	5%	RMC1/10T 223J	J24205223		1-	
R 2267	CHIP RES.	10k	1/10W	5%	RMC1/10T 103J	J24205103		1-	
R 2268	CHIP RES.	47k	1/10W	5%	RMC1/10T 473J	J24205473		1-	
R 2269	CHIP RES.	10k	1/10W	5%	RMC1/10T 103J	J24205103		1-	
R 2270	CHIP RES.	330	1/10W	5%	RMC1/10T 331J	J24205331		1-	
R 2271	CHIP RES.	330	1/10W	5%	RMC1/10T 331J	J24205331		1-	
R 2272	CHIP RES.	5.6k	1/10W	5%	RMC1/10T 562J	J24205562		1-	
R 2273	CHIP RES.	220	1/10W	5%	RMC1/10T 221J	J24205221		1-	
R 2274	CHIP RES.	1.8k	1/10W	5%	RMC1/10T 182J	J24205182		1-	
R 2275	CHIP RES.	0	1/10W	5%	RMC1/10T 000J	J24205000		1-	
R 2276	CHIP RES.	2.2k	1/10W	5%	RMC1/10T 222J	J24205222		1-	
R 2277	CHIP RES.	6.8k	1/10W	5%	RMC1/10T 682J	J24205682		1-	
R 2278	CHIP RES.	100k	1/10W	5%	RMC1/10T 104J	J24205104		1-	
R 2279	CHIP RES.	15k	1/10W	5%	RMC1/10T 153J	J24205153		1-	
R 2280	CHIP RES.	2.2k	1/10W	5%	RMC1/10T 222J	J24205222		1-	
R 2281	CHIP RES.	15k	1/10W	5%	RMC1/10T 153J	J24205153		1-	
R 2282	CHIP RES.	47	1/10W	5%	RMC1/10T 470J	J24205470		1-	
R 2283	CHIP RES.	33k	1/10W	5%	RMC1/10T 333J	J24205333		1-	
R 2284	CHIP RES.	15k	1/10W	5%	RMC1/10T 153J	J24205153		1-	
R 2285	CHIP RES.	330	1/10W	5%	RMC1/10T 331J	J24205331		1-	
R 2286	CHIP RES.	1.5k	1/10W	5%	RMC1/10T 152J	J24205152		1-	
R 2287	CARBON FILM RES.	150	1/6W	5%	RD16TPJ151 150	J07225151		1-	
R 2287	CHIP RES.	150	1/10W	5%	RMC1/10T 151J	J24205151		32-	
R 2289	CHIP RES.	150k	1/10W	5%	RMC1/10T 154J	J24205154		32-	
R 2290	CHIP RES.	0	1/10W	5%	RMC1/10T 000J	J24205000		32-	
R 2291	CHIP RES.	1.5k	1/10W	5%	RMC1/10T 152J	J24205152		32-	
R 2292	CHIP RES.	33k	1/10W	5%	RMC1/10T 333J	J24205333		32-	
R 2293	CHIP RES.	22k	1/10W	5%	RMC1/10T 223J	J24205223		32-	
R 2294	CHIP RES.	1.5k	1/10W	5%	RMC1/10T 152J	J24205152		32-	
T 2001	COIL 07RF	8.2MHz			8.20M R12-4043A	L0021199		1-	
T 2002	COIL 07RF	8.2MHz			8.20M R12-4043A	L0021199		1-	
T 2003	COIL 07RF	455kHz			455K	L0190002		1-	
T 2004	COIL 07RF	8.2MHz			8.20M R12-4043A	L0021199		1-	
T 2005	COIL 07RF	73.62MHz			73.62M R12-J759A	L0021961		1-	
T 2006	COIL 07RF	8.21MHz			8.21M R12-6368A	L0021396		1-	
T 2007	COIL 07RF	8.2MHz			8.20M R12-4043A	L0021199		1-	
T 2008	COIL 07RF	8.21MHz			8.21M R12-6368A	L0021396		1-	
T 2009	COIL 07RF	455kHz			455K	L0190002		1-	
T 2010	COIL 07RF				R12-J760A	L0021962		1-	
T 2011	COIL 07RF	455kHz			455K	L0190002		1-	
T 2012	COIL RF				R12°7943B	L0020420		1-	
T 2013	COIL 07RF	8.2MHz			8.20M R12-4043A	L0021199		1-	
T 2014	COIL 07RF				R12-J758A	L0021958		1-	
T 2015	COIL 07RF	8.2MHz			8.20M R12-4043A	L0021199		1-	
T 2016	COIL 07RF	455kHz			455K	L0190002		1-	
T 2017	COIL 07RF	73.62MHz			73.62M R12-J759A	L0021961		1-	
T 2018	COIL 07RF	8.21MHz			8.21M R12-6367A	L0021395		1-	
T 2019	COIL RF				R12°7935A	L0020421		1-	
TH2001	THERMISTOR				157-252-53006TP	G9090053		1-	
TH2002	THERMISTOR				157-502-53002TP	G9090049		1-	
TH2003	THERMISTOR				157-502-53002TP	G9090049		1-	
TH2004	THERMISTOR				157-501-53009TP	G9090058		1-	
TH2005	THERMISTOR				157-501-53009TP	G9090058		1-	
TH2006	THERMISTOR				157-501-53009TP	G9090058		1-	
TP2001	TERMINAL				TP-K IPS-1136	Q5000050		1-	
TP2002	TERMINAL				TP-K IPS-1136	Q5000050		1-	

IF Unit

Parts List

REF.	DESCRIPTION	VALUE	V/W	TOL.	MFR'S DESIG	YAESU P/N	VERS.	LOT.	LAY ADR
TP2003	TERMINAL				TP-K IPS-1136	Q5000050		1-	
TP2004	TERMINAL				TP-K IPS-1136	Q5000050		1-	
TP2005	TERMINAL				TP-K IPS-1136	Q5000050		1-	
VR2001	POT.	2.2k			RH063MCJ3R 2.2KB	J51794222		1-	
VR2002	POT.	10k			RH063MC14R 10KB	J51794103		1-	
VR2003	POT.	10k			RH063MC14R 10KB	J51794103		1-	
VR2004	POT.	1k			RH063MC13R 1KB	J51794102		1-	
VR2005	POT.	4.7k			RH063MCS3R 4.7KB	J51794472		1-	
VR2006	POT.	1k			RH063MC13R 1KB	J51794102		1-	
VR2007	POT.	10k			RH063MC14R 10KB	J51794103		1-	
VR2008	POT.	10k			RH063MC14R 10KB	J51794103		1-	
VR2009	POT.	10k			RH063MC14R 10KB	J51794103		1-	
X 2001	XTAL HC-49/U	8.215MHz			8.215MHZ	H0102934		1-	
XF2001	XTAL FILTER	8.2MHz			8.2M12	H1102156		1-	
XF2002	XTAL FILTER				XF-8.2M-501-03	H1102158		1-	
XF2003	XTAL FILTER				XF-8.2M-262-01	H1102157		1-	
	CARD SPACER				WLS-04-0	S6000191		1-	

IF Unit

Note

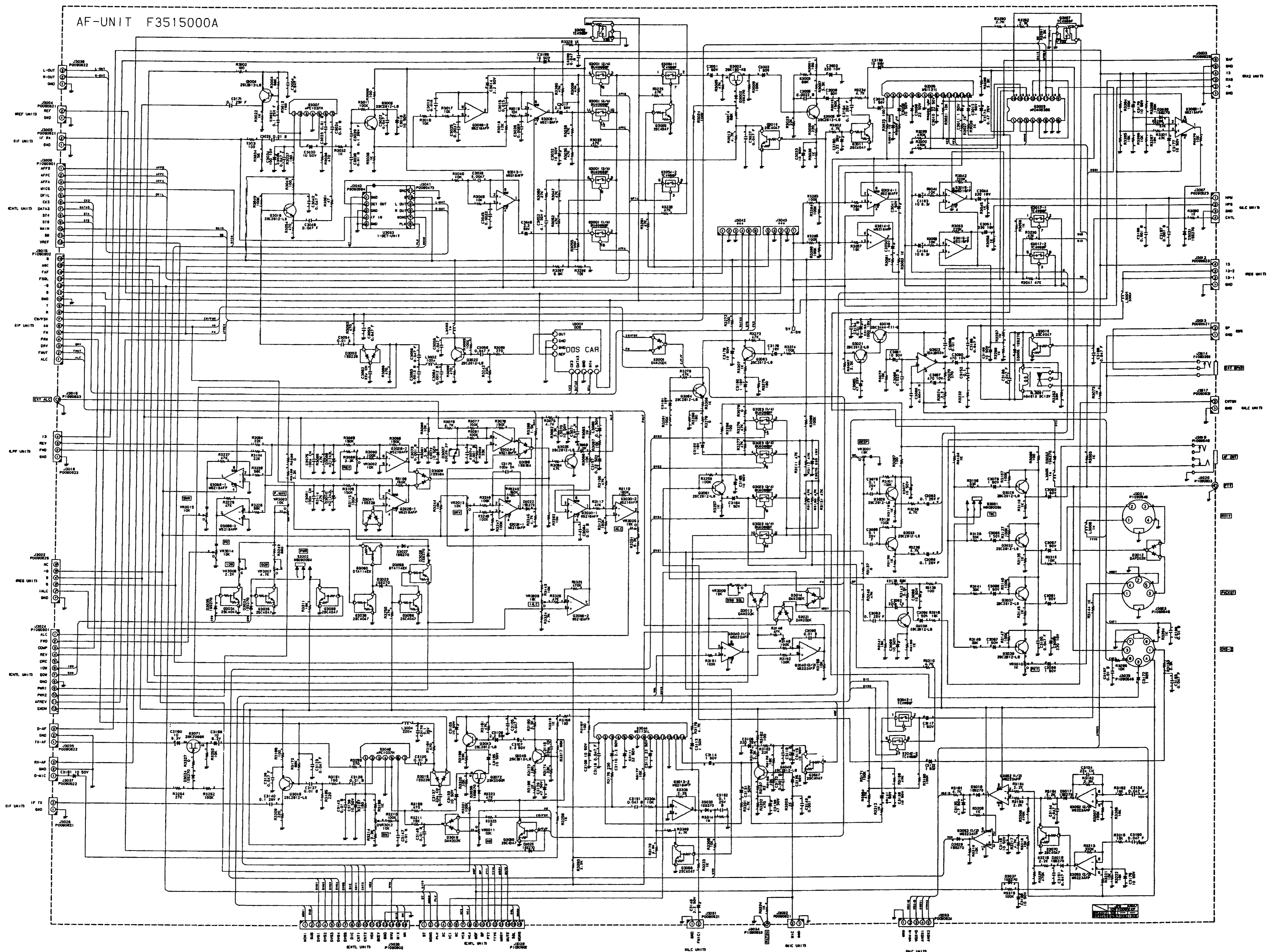

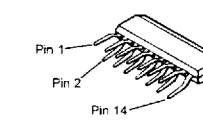

M51131L
(Q3005, Q3044)

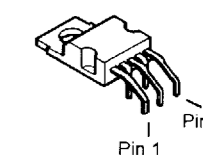

TDA2003
(Q3022)

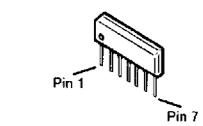

μPC1037H
(Q3007, Q3046)

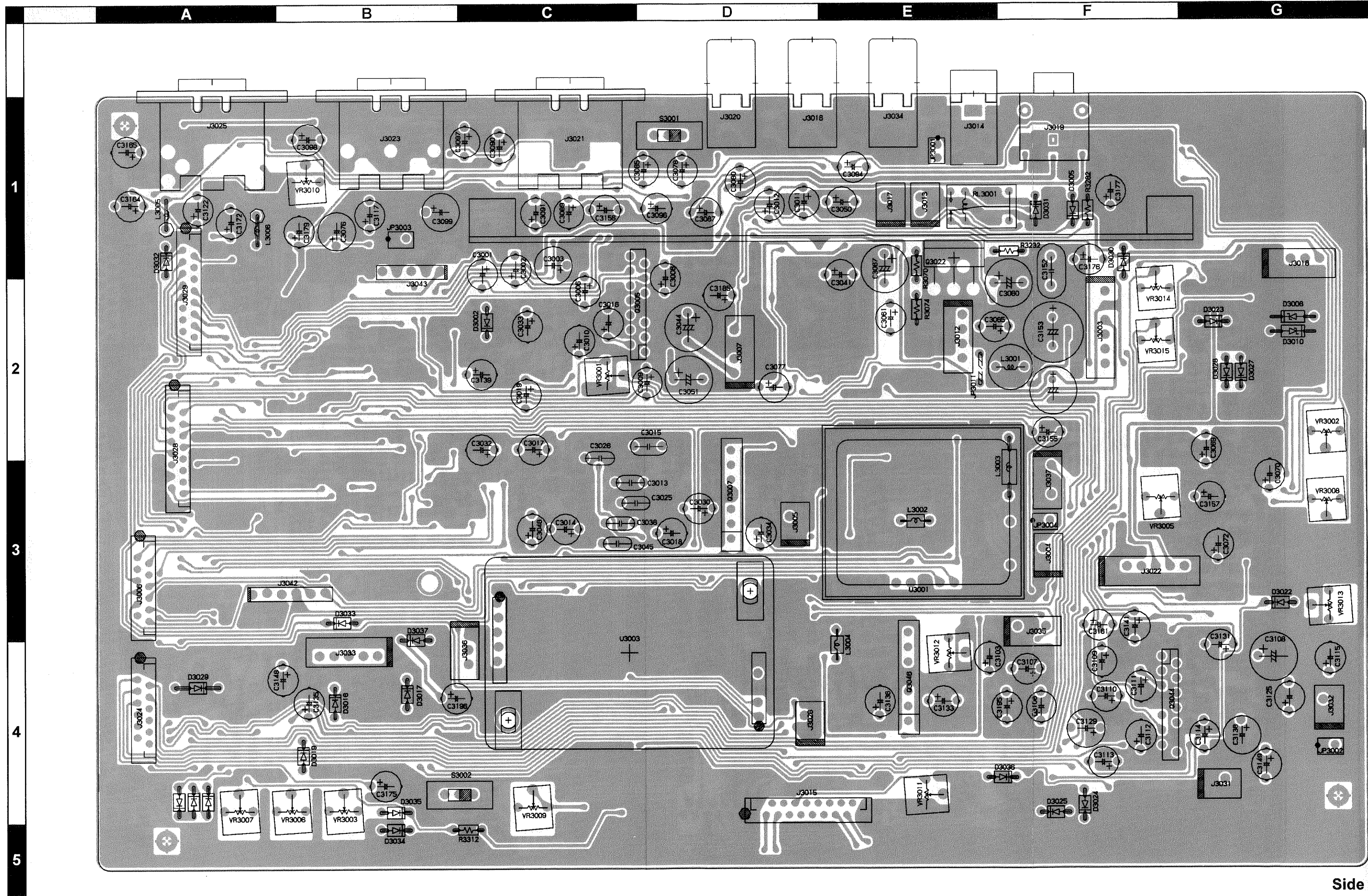

Side A

AF Unit
Parts Layout

a b c d e f g

1

2

3

4

5

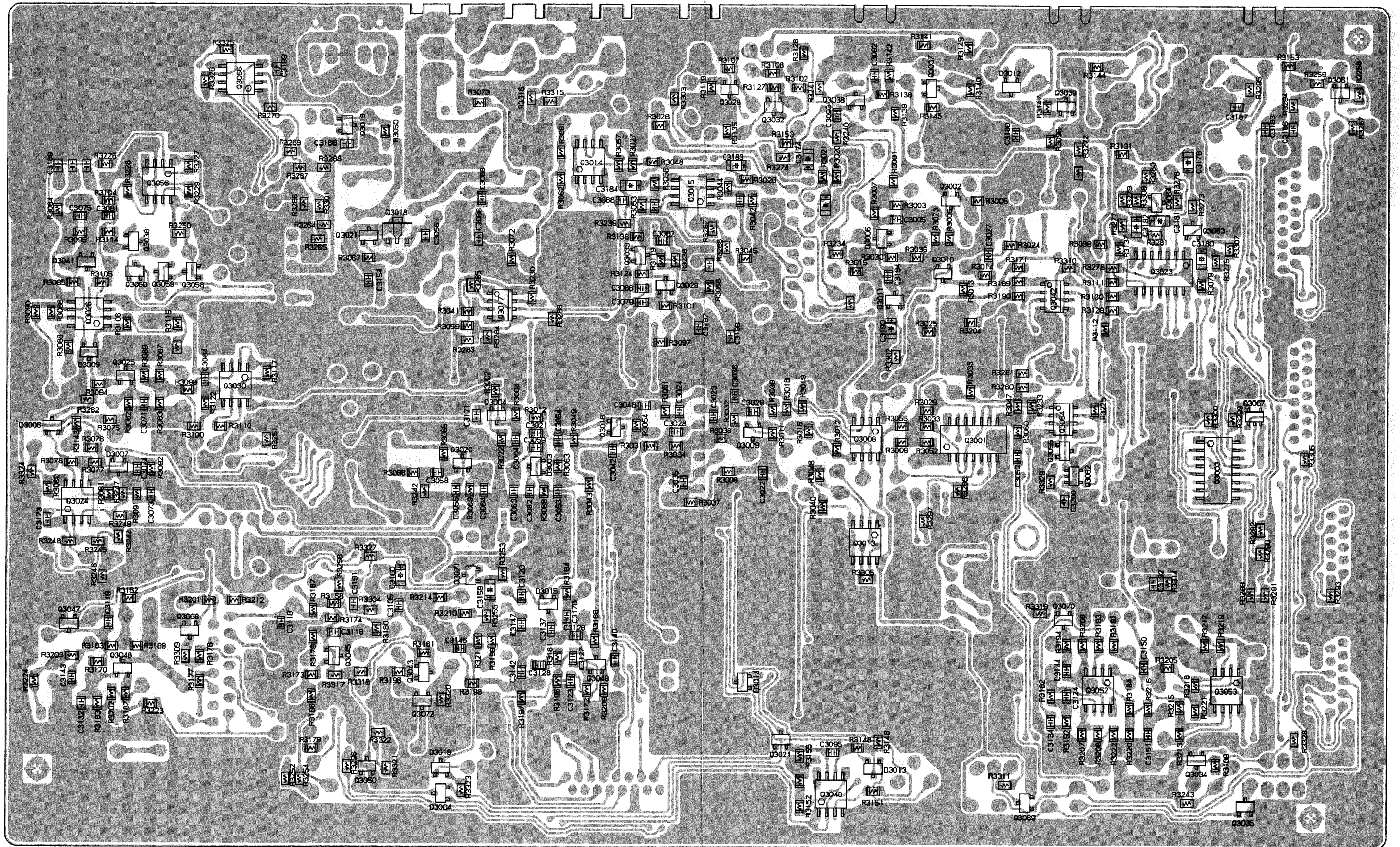

Side B

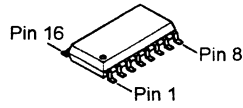

UPD4053BG-T2
(Q3003)

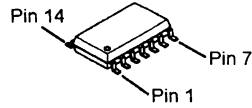

BU4066BF-E2
(Q3001, Q3023)

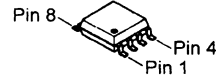

M5223AFP
(Q3040, Q3052, Q3053)

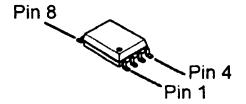

M5216FP
(Q3015)

M5218AFP
(Q3008, Q3013, Q3014,
Q3024, Q3026, Q3030,
Q3056, Q3066)



TC4W66F
(Q3017, Q3042, Q3054)

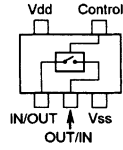

TC4S66F (C9)
(Q3062, Q3067)

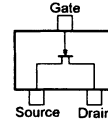

2SK160 (K6)
(Q3002)

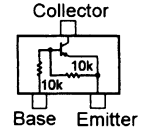

DTA114EK (14)
(Q3059, Q3060)

2SK209GR (XG)
(Q3071, Q3072)

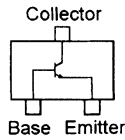

2SC2812 (L6)
(Q3004, Q3006, Q3009
Q3016, Q3020, Q3021
Q3025, Q3028, Q3029
Q3032, Q3033, Q3037
Q3038, Q3039, Q3043
Q3045, Q3048, Q3049
Q3061, Q3063, Q3064)

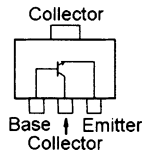

2SC3444 (DE)
(Q3018)

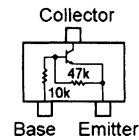

2SC4047 (ZY)
(Q3010, Q3011, Q3019
Q3034, Q3035, Q3036
Q3047, Q3050, Q3055
Q3058, Q3068, Q3069
Q3070)

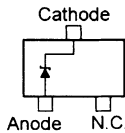

02CZ8.2Y (8.2)
(D3007)

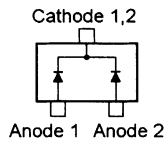

1SS184 (B3)
(D3006, D3009)

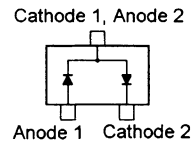

1SS226 (C3)
(D3003, D3015, D3041)

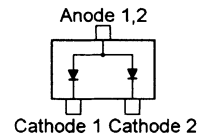

DAP202K (P)
(D3012)

DAN202K (N)
(D3004, D3013, D3014
D3018, D3021)

AF Unit

Parts List

REF.	DESCRIPTION	VALUE	V/W	TOL.	MFR'S DESIG	YAESU P/N	VERS.	LOT.	LAY ADR
	PCB with Components					CP6681001	W/OCE LABEL		
	PCB with Components					CP6681002	W/CE LABEL		
	Printed Circuit Board					F3515000A		1-	
C 3001	AL.ELECTRO.CAP.	1uF	50V		50V010M5X11TR5	K46170017		1-	
C 3002	AL.ELECTRO.CAP.	1uF	50V		50V010M5X11TR5	K46170017		1-	
C 3003	AL.ELECTRO.CAP.	220uF	10V		10V221M6X11TR5	K46100005		1-	
C 3004	CHIPCAP.	0.047uF	50V	F	GRM40F473Z50PT	K22171008		1-	
C 3005	CHIPCAP.	0.0022uF	50V	B	GRM40B222M50PT	K22170809		1-	
C 3006	AL.ELECTRO.CAP.	1uF	50V		50V010M5X11TR5	K46170017		1-	
C 3008	AL.ELECTRO.CAP.	10uF	50V		50V100M5X11TR5	K46170021		1-	
C 3009	AL.ELECTRO.CAP.	22uF	50V		50V220M5X11TR5	K46170022		1-	
C 3010	AL.ELECTRO.CAP.	22uF	50V		50V220M5X11TR5	K46170022		1-	
C 3011	AL.ELECTRO.CAP.	1uF	50V		50V010M5X11TR5	K46170017		1-	
C 3012	AL.ELECTRO.CAP.	1uF	50V		50V010M5X11TR5	K46170017		1-	
C 3013	FILM CAP.	0.015uF	50V		AMZV0050K15300000200	K56170035		1-	
C 3014	AL.ELECTRO.CAP.	2.2uF	50V		50V2R2M5X11TR5	K46170018		1-	
C 3015	FILM CAP.	0.015uF	50V		AMZV0050K15300000200	K56170035		1-	
C 3016	AL.ELECTRO.CAP.	1uF	50V		50V010M5X11TR5	K46170017		1-	
C 3017	AL.ELECTRO.CAP.	2.2uF	50V		50V2R2M5X11TR5	K46170018		1-	
C 3018	AL.ELECTRO.CAP.	10uF	50V		50V100M5X11TR5	K46170021		1-	
C 3019	AL.ELECTRO.CAP.	10uF	50V		50V100M5X11TR5	K46170021		1-	
C 3021	CHIPCAP.	0.1uF	25V	F	GRM40F104Z25PT	K22141005		1-	
C 3022	CHIPCAP.	0.047uF	50V	F	GRM40F473Z50PT	K22171008		1-	
C 3023	CHIPCAP.	0.01uF	50V	B	GRM40B103M50PT	K22170817		1-	
C 3024	CHIPCAP.	0.01uF	50V	B	GRM40B103M50PT	K22170817		1-	
C 3025	FILM CAP.	0.0047uF	50V		AMZV0050K47200000200	K56170032		1-	
C 3026	FILM CAP.	0.0068uF	50V		AMZV0050K68200000200	K56170033		1-	
C 3027	CHIPCAP.	0.047uF	50V	F	GRM40F473Z50PT	K22171008		1-	
C 3028	CHIPCAP.	0.01uF	50V	B	GRM40B103M50PT	K22170817		1-	
C 3029	CHIPCAP.	0.1uF	25V	F	GRM40F104Z25PT	K22141005		1-	
C 3030	AL.ELECTRO.CAP.	10uF	50V		50V100M5X11TR5	K46170021		1-	
C 3032	AL.ELECTRO.CAP.	10uF	50V		50V100M5X11TR5	K46170021		1-	
C 3033	AL.ELECTRO.CAP.	10uF	50V		50V100M5X11TR5	K46170021		1-	
C 3034	AL.ELECTRO.CAP.	100uF	10V		10V101M5X11TR5	K46100004		1-	
C 3035	CHIPCAP.	0.047uF	50V	F	GRM40F473Z50PT	K22171008		1-	
C 3036	CHIPCAP.	0.01uF	50V	B	GRM40B103M50PT	K22170817		1-	
C 3038	FILM CAP.	0.0047uF	50V		AMZV0050K47200000200	K56170032		1-	
C 3041	AL.ELECTRO.CAP.	1uF	50V		50V010M5X11TR5	K46170017		1-	
C 3042	CHIPCAP.	0.047uF	50V	F	GRM40F473Z50PT	K22171008		1-	
C 3044	AL.ELECTRO.CAP.	330uF	16V		16V331M8X11TR5	K46120002		1-	
C 3045	FILM CAP.	0.0022uF	50V		AMZV0050K22200000200	K56170030		1-	
C 3046	AL.ELECTRO.CAP.	2.2uF	50V		50V2R2M5X11TR5	K46170018		1-	
C 3048	CHIPCAP.	0.047uF	50V	F	GRM40F473Z50PT	K22171008		1-	
C 3050	AL.ELECTRO.CAP.	1uF	50V		50V010M5X11TR5	K46170017		1-	
C 3051	AL.ELECTRO.CAP.	330uF	16V		16V331M8X11TR5	K46120002		1-	
C 3052	CHIPCAP.	0.1uF	25V	F	GRM40F104Z25PT	K22141005		1-	
C 3053	CHIPCAP.	0.047uF	50V	F	GRM40F473Z50PT	K22171008		1-	
C 3054	CHIPCAP.	0.01uF	50V	B	GRM40B103M50PT	K22170817		1-	
C 3055	CHIPCAP.	0.047uF	50V	F	GRM40F473Z50PT	K22171008		1-	
C 3056	CHIPCAP.	0.01uF	50V	B	GRM40B103M50PT	K22170817		1-	
C 3058	CHIPCAP.	0.047uF	50V	F	GRM40F473Z50PT	K22171008		1-	
C 3059	CHIPCAP.	0.047uF	50V	F	GRM40F473Z50PT	K22171008		1-	
C 3060	AL.ELECTRO.CAP.	470uF	10V		10V471M8X11TR5	K46100006		1-	
C 3061	AL.ELECTRO.CAP.	10uF	50V		50V100M5X11TR5	K46170021		1-	
C 3062	CHIPCAP.	22pF	50V	CH	GRM40CH220J50PT	K22170219		1-	
C 3063	CHIPCAP.	0.0012uF	50V	B	GRM40B122M50PT	K22170806		1-	
C 3064	CHIPCAP.	0.0012uF	50V	B	GRM40B122M50PT	K22170806		1-	
C 3065	AL.ELECTRO.CAP.	47uF	25V		25V470M5X11TR5	K46140004		1-	
C 3066	CHIPCAP.	0.022uF	50V	B	GRM40B223M50PT	K22170821		1-	
C 3067	AL.ELECTRO.CAP.	470uF	10V		10V471M8X11TR5	K46100006		1-	
C 3068	CHIPCAP.	0.0047uF	50V	B	GRM40B472M50PT	K22170813		1-	
C 3069	AL.ELECTRO.CAP.	0.47uF	50V		50VR47M5X11TR5	K46170016		1-	
C 3070	AL.ELECTRO.CAP.	10uF	50V		50V100M5X11TR5	K46170021		1-	
C 3071	CHIPCAP.	0.01uF	50V	B	GRM40B103M50PT	K22170817		1-	
C 3072	AL.ELECTRO.CAP.	10uF	50V		50V100M5X11TR5	K46170021		1-	
C 3073	CHIPCAP.	0.001uF	50V	B	GRM40B102M50PT	K22170805		1-	
C 3074	CHIPCAP.	0.001uF	50V	B	GRM40B102M50PT	K22170805		1-	
C 3075	CHIPCAP.	100pF	50V	CH	GRM40CH101J50PT	K22170235		1-	

AF Unit

Parts List

REF.	DESCRIPTION	VALUE	V/W	TOL.	MFR'S DESIG	YAESU P/N	VERS.	LOT.	LAY ADR
C 3076	AL.ELECTRO.CAP.	220uF	10V		10V221M6X11TR5	K46100005		1-	
C 3077	AL.ELECTRO.CAP.	10uF	50V		50V100M5X11TR5	K46170021		1-	
C 3078	AL.ELECTRO.CAP.	1uF	50V		50V010M5X11TR5	K46170017		1-	
C 3079	CHIPCAP.	0.1uF	25V	F	GRM40F104Z25PT	K22141005		1-	
C 3080	AL.ELECTRO.CAP.	1uF	50V		50V010M5X11TR5	K46170017		1-	
C 3081	CHIPCAP.	100pF	50V	CH	GRM40CH101J50PT	K22170235		1-	
C 3082	CHIPCAP.	0.1uF	25V	F	GRM40F104Z25PT	K22141005		1-	
C 3084	CHIPCAP.	0.01uF	50V	B	GRM40B103M50PT	K22170817		1-	
C 3085	AL.ELECTRO.CAP.	1uF	50V		50V010M5X11TR5	K46170017		1-	
C 3086	CHIPCAP.	0.1uF	25V	F	GRM40F104Z25PT	K22141005		1-	
C 3087	AL.ELECTRO.CAP.	1uF	50V		50V010M5X11TR5	K46170017		1-	
C 3088	CHIPCAP.	0.1uF	25V	F	GRM40F104Z25PT	K22141005		1-	
C 3089	AL.ELECTRO.CAP.	10uF	50V		50V100M5X11TR5	K46170021		1-	
C 3090	AL.ELECTRO.CAP.	1uF	50V		50V010M5X11TR5	K46170017		1-	
C 3091	AL.ELECTRO.CAP.	1uF	50V		50V010M5X11TR5	K46170017		1-	
C 3092	CHIPCAP.	220pF	50V	CH	GRM40CH221J50PT	K22170243		1-	
C 3093	CHIPCAP.	0.1uF	25V	F	GRM40F104Z25PT	K22141005		1-	
C 3094	AL.ELECTRO.CAP.	1uF	50V		50V010M5X11TR5	K46170017		1-	
C 3095	CHIPCAP.	0.01uF	50V	B	GRM40B103M50PT	K22170817		1-	
C 3096	AL.ELECTRO.CAP.	10uF	50V		50V100M5X11TR5	K46170021		1-	
C 3097	AL.ELECTRO.CAP.	1uF	50V		50V010M5X11TR5	K46170017		1-	
C 3098	AL.ELECTRO.CAP.	1uF	50V		50V010M5X11TR5	K46170017		1-	
C 3099	AL.ELECTRO.CAP.	220uF	10V		10V221M6X11TR5	K46100005		1-	
C 3100	CHIPCAP.	0.047uF	50V	F	GRM40F473Z50PT	K22171008		1-	
C 3103	AL.ELECTRO.CAP.	10uF	50V		50V100M5X11TR5	K46170021		1-	
C 3105	CHIPCAP.	0.047uF	50V	F	GRM40F473Z50PT	K22171008		1-	
C 3106	AL.ELECTRO.CAP.	2.2uF	50V		50V2R2M5X11TR5	K46170018		1-	
C 3107	AL.ELECTRO.CAP.	2.2uF	50V		50V2R2M5X11TR5	K46170018		1-	
C 3108	AL.ELECTRO.CAP.	220uF	25V		25V221M8X11TR5	K46140006		1-	
C 3109	AL.ELECTRO.CAP.	10uF	50V		50V100M5X11TR5	K46170021		1-	
C 3110	AL.ELECTRO.CAP.	2.2uF	50V		50V2R2M5X11TR5	K46170018		1-	
C 3111	AL.ELECTRO.CAP.	22uF	50V		50V220M5X11TR5	K46170022		1-	
C 3112	AL.ELECTRO.CAP.	22uF	50V		50V220M5X11TR5	K46170022		1-	
C 3113	AL.ELECTRO.CAP.	1uF	50V		50V010M5X11TR5	K46170017		1-	
C 3114	AL.ELECTRO.CAP.	1uF	50V		50V010M5X11TR5	K46170017		1-	
C 3115	AL.ELECTRO.CAP.	10uF	50V		50V100M5X11TR5	K46170021		1-	
C 3116	CHIPCAP.	220pF	50V	CH	GRM40CH221J50PT	K22170243		1-	
C 3117	AL.ELECTRO.CAP.	1uF	50V		50V010M5X11TR5	K46170017		1-	
C 3118	CHIPCAP.	0.047uF	50V	F	GRM40F473Z50PT	K22171008		1-	
C 3119	CHIPCAP.	0.01uF	50V	B	GRM40B103M50PT	K22170817		1-	
C 3120	CHIPCAP.	0.01uF	50V	B	GRM40B103M50PT	K22170817		1-	
C 3122	AL.ELECTRO.CAP.	1uF	50V		50V010M5X11TR5	K46170017		1-	
C 3123	CHIPCAP.	0.047uF	50V	F	GRM40F473Z50PT	K22171008		1-	
C 3124	CHIPCAP.	22pF	50V	CH	GRM40CH220J50PT	K22170219		1-	
C 3125	AL.ELECTRO.CAP.	1uF	50V		50V010M5X11TR5	K46170017		1-	
C 3126	CHIPCAP.	0.047uF	50V	F	GRM40F473Z50PT	K22171008		1-	
C 3127	CHIPCAP.	0.01uF	50V	B	GRM40B103M50PT	K22170817		1-	
C 3128	CHIPCAP.	0.01uF	50V	B	GRM40B103M50PT	K22170817		1-	
C 3129	AL.ELECTRO.CAP.	47uF	50V		50V470M6X11TR5	K46170024		1-	
C 3131	AL.ELECTRO.CAP.	1uF	50V		50V010M5X11TR5	K46170017		1-	
C 3132	CHIPCAP.	0.001uF	50V	B	GRM40B102M50PT	K22170805		1-	
C 3133	AL.ELECTRO.CAP.	10uF	50V		50V100M5X11TR5	K46170021		1-	
C 3134	CHIPCAP.	0.047uF	50V	F	GRM40F473Z50PT	K22171008		1-	
C 3135	AL.ELECTRO.CAP.	4.7uF	50V		50V4R7M5X11TR5	K46170020		1-	
C 3136	AL.ELECTRO.CAP.	10uF	50V		50V100M5X11TR5	K46170021		1-	
C 3137	CHIPCAP.	22pF	50V	CH	GRM40CH220J50PT	K22170219		1-	
C 3138	AL.ELECTRO.CAP.	47uF	50V		50V470M6X11TR5	K46170024		1-	
C 3139	AL.ELECTRO.CAP.	10uF	50V		50V100M5X11TR5	K46170021		1-	
C 3140	CHIPCAP.	0.1uF	25V	F	GRM40F104Z25PT	K22141005		1-	
C 3141	AL.ELECTRO.CAP.	1uF	50V		50V010M5X11TR5	K46170017		1-	
C 3142	CHIPCAP.	0.01uF	50V	B	GRM40B103M50PT	K22170817		1-	
C 3143	CHIPCAP.	0.001uF	50V	B	GRM40B102M50PT	K22170805		1-	
C 3144	CHIPCAP.	0.047uF	50V	F	GRM40F473Z50PT	K22171008		1-	
C 3146	CHIPCAP.	0.01uF	50V	B	GRM40B103M50PT	K22170817		1-	
C 3147	CHIPCAP.	0.01uF	50V	B	GRM40B103M50PT	K22170817		1-	
C 3148	AL.ELECTRO.CAP.	10uF	50V		50V100M5X11TR5	K46170021		1-	
C 3149	AL.ELECTRO.CAP.	2.2uF	50V		50V2R2M5X11TR5	K46170018		1-	
C 3150	CHIPCAP.	0.047uF	50V	F	GRM40F473Z50PT	K22171008		1-	

AF Unit

Parts List

REF.	DESCRIPTION	VALUE	V/W	TOL.	MFR'S DESIG	YAESU P/N	VERS.	LOT.	LAY ADR
C 3151	CHIPCAP.	0.047uF	50V	F	GRM40F473Z50PT	K22171008		1-	
C 3152	FILM CAP.	0.1uF	50V		AMZV0050K10400000200	K56170040		1-	
C 3153	AL.ELECTRO.CAP.	1000uF	16V		RE2-16V102M 1000UF	K40129046		1-	
C 3154	CHIPCAP.	0.01uF	50V	B	GRM40B103M50PT	K22170817		1-	
C 3155	AL.ELECTRO.CAP.	10uF	50V		50V100M5X11TR5	K46170021		1-	
C 3156	AL.ELECTRO.CAP.	10uF	50V		50V100M5X11TR5	K46170021		1-	
C 3157	AL.ELECTRO.CAP.	0.22uF	50V		50VR22M5X11TR5	K46170014		1-	
C 3159	CHIPTA.CAP.	10uF	6.3V		TEMSVA0J106M-8R	K78080027		1-	
C 3160	CHIPTA.CAP.	10uF	6.3V		TEMSVA0J106M-8R	K78080027		1-	
C 3161	AL.ELECTRO.CAP.	10uF	50V		50V100M5X11TR5	K46170021		1-	
C 3164	AL.ELECTRO.CAP.	1uF	50V		50V010M5X11TR5	K46170017		1-	
C 3165	AL.ELECTRO.CAP.	10uF	50V		50V100M5X11TR5	K46170021		1-	
C 3170	CHIPCAP.	0.1uF	25V	F	GRM40F104Z25PT	K22141005		1-	
C 3171	CHIPCAP.	0.1uF	25V	F	GRM40F104Z25PT	K22141005		1-	
C 3172	AL.ELECTRO.CAP.	1uF	50V		50V010M5X11TR5	K46170017		1-	
C 3173	CHIPCAP.	100pF	50V	CH	GRM40CH101J50PT	K22170235		1-	
C 3174	CHIPTA.CAP.	0.47uF	25V		TESVA1E474M1-8R	K78140009		1-	
C 3175	AL.ELECTRO.CAP.	10uF	50V		50V100M5X11TR5	K46170021		1-	
C 3176	AL.ELECTRO.CAP.	10uF	50V		50V100M5X11TR5	K46170021		1-	
C 3177	AL.ELECTRO.CAP.	10uF	50V		50V100M5X11TR5	K46170021		1-	
C 3178	CHIPTA.CAP.	1uF	16V		TESVA1C105M1-8R	K78120009		1-	
C 3179	AL.ELECTRO.CAP.	10uF	50V		50V100M5X11TR5	K46170021		1-	
C 3180	CHIPTA.CAP.	1uF	16V		TESVA1C105M1-8R	K78120009		1-	
C 3181	CHIPTA.CAP.	1uF	16V		TESVA1C105M1-8R	K78120009		1-	
C 3182	CHIPTA.CAP.	1uF	16V		TESVA1C105M1-8R	K78120009		1-	
C 3183	CHIPTA.CAP.	10uF	6.3V		TEMSVA0J106M-8R	K78080027		1-	
C 3184	CHIPTA.CAP.	10uF	6.3V		TEMSVA0J106M-8R	K78080027		1-	
C 3185	AL.ELECTRO.CAP.	10uF	50V		50V100M5X11TR5	K46170021		1-	
C 3186	CHIPCAP.	0.01uF	50V	B	GRM40B103M50PT	K22170817		1-	
C 3187	CHIPCAP.	0.01uF	50V	B	GRM40B103M50PT	K22170817		1-	
C 3188	CHIPCAP.	0.047uF	50V	F	GRM40F473Z50PT	K22171008		1-	
C 3189	CHIPCAP.	0.047uF	50V	F	GRM40F473Z50PT	K22171008		1-	
C 3190	CHIPTA.CAP.	0.22uF	35V		TESVA1V224M1-8R	K78160027		1-	
C 3191	CHIPCAP.	0.047uF	50V	B	GRM40B473M50PT	K22170823		1-	
C 3192	CHIPCAP.	0.1uF	25V	B	GRM40B104M25PT	K22140811		1-	
C 3193	CHIPCAP.	0.047uF	50V	F	GRM40F473Z50PT	K22171008		1-	
C 3194	CHIPCAP.	0.1uF	25V	F	GRM40F104Z25PT	K22141005		1-	
C 3195	AL.ELECTRO.CAP.	10uF	50V		50V100M5X11TR5	K46170021		1-	
C 3196	AL.ELECTRO.CAP.	10uF	50V		50V100M5X11TR5	K46170021		1-	
C 3197	CHIPCAP.	0.001uF	50V	B	GRM40B102M50PT	K22170805		1-	
C 3198	CHIPCAP.	0.001uF	50V	B	GRM40B102M50PT	K22170805		1-	
C 3199	CHIPCAP.	0.047uF	50V	F	GRM40F473Z50PT	K22171008		1-	
C 3200	CHIPCAP.	0.047uF	50V	B	GRM40B473M50PT	K22170823		1-	
D 3002	DIODE				1SS270TJ	G2060004		1-	C2
D 3002	DIODE				1SS133 T-77	G2060001		27-	C2
D 3003	DIODE				1SS226 TE85R	G2070003		1-	c3
D 3004	DIODE				DAN202K T146	G2070182		1-	c4
D 3005	DIODE				1SS270TJ	G2060004		1-	F1
D 3005	DIODE				1SS133 T-77	G2060001		27-	F1
D 3006	DIODE				1SS184 TE85R	G2070009		1-	a3
D 3007	DIODE				02CZ8.2Y TE85R	G2070146		1-	a3
D 3008	DIODE				HZ12A2L TE	G2060015		1-	G2
D 3009	DIODE				1SS184 TE85R	G2070009		1-	a1
D 3010	DIODE				HZ12A2L TE	G2060015		1-	G2
D 3012	DIODE				DAP202K T146	G2070180		1-	f1
D 3013	DIODE				DAN202K T146	G2070182		1-	e4
D 3014	DIODE				DAN202K T146	G2070182		1-	d4
D 3015	DIODE				1SS226 TE85R	G2070003		1-	c4
D 3016	DIODE				1SS270TJ	G2060004		1-	B4
D 3016	DIODE				1SS133 T-77	G2060001		27-	B4
D 3017	DIODE				1SS270TJ	G2060004		1-	B4
D 3017	DIODE				1SS133 T-77	G2060001		27-	B4
D 3018	DIODE				DAN202K T146	G2070182		1-	c4
D 3019	DIODE				1SS270TJ	G2060004		1-	B4
D 3019	DIODE				1SS133 T-77	G2060001		27-	B4
D 3021	DIODE				DAN202K T146	G2070182		1-	d4
D 3022	DIODE				1SS270TJ	G2060004		1-	G4
D 3022	DIODE				1SS133 T-77	G2060001		27-	G4

AF Unit

Parts List

REF.	DESCRIPTION	VALUE	V/W	TOL.	MFR'S DESIG	YAESU P/N	VERS.	LOT.	LAY ADR
D 3023	DIODE				1SS270TJ	G2060004		1-	G4
D 3023	DIODE				1SS133 T-77	G2060001		27-	G4
D 3024	DIODE				1SS270TJ	G2060004		1-	F4
D 3024	DIODE				1SS133 T-77	G2060001		27-	F4
D 3025	DIODE				1SS270TJ	G2060004		1-	F4
D 3025	DIODE				1SS133 T-77	G2060001		27-	F4
D 3027	DIODE				1SS270TJ	G2060004		1-	G2
D 3027	DIODE				1SS133 T-77	G2060001		27-	G2
D 3028	DIODE				1SS270TJ	G2060004		1-	G2
D 3028	DIODE				1SS133 T-77	G2060001		27-	G2
D 3029	DIODE				1SS270TJ	G2060004		1-	A4
D 3029	DIODE				1SS133 T-77	G2060001		27-	A4
D 3030	DIODE				1SS270TJ	G2060004		1-	F1
D 3030	DIODE				1SS133 T-77	G2060001		27-	F1
D 3031	DIODE				1SS270TJ	G2060004		1-	F1
D 3031	DIODE				1SS133 T-77	G2060001		27-	F1
D 3032	DIODE				1SS270TJ	G2060004		1-	A1
D 3032	DIODE				1SS133 T-77	G2060001		27-	A1
D 3033	DIODE				1SS270TJ	G2060004		1-	B3
D 3033	DIODE				1SS133 T-77	G2060001		27-	B3
D 3034	DIODE				1SS270TJ	G2060004		1-	B5
D 3034	DIODE				1SS133 T-77	G2060001		27-	B5
D 3035	DIODE				1SS270TJ	G2060004		1-	B4
D 3035	DIODE				1SS133 T-77	G2060001		27-	B4
D 3036	DIODE				1SS270TJ	G2060004		1-	E4
D 3036	DIODE				1SS133 T-77	G2060001		27-	E4
D 3037	DIODE				1SS270TJ	G2060004		1-	B4
D 3037	DIODE				1SS133 T-77	G2060001		27-	B4
D 3041	DIODE				1SS226 TE85R	G2070003		1-	a1
J 3003	CONNECTOR				SC25-06WS	P0090625		1-	
J 3004	CONNECTOR				SC25-02WS	P0090621		1-	
J 3005	CONNECTOR				SC25-02WS	P0090621		1-	
J 3006	CONNECTOR				12FMZ-BT	P1090901		1-	
J 3007	CONNECTOR				SC25-04WS	P0090623		1-	
J 3012	CONNECTOR				SC25-04WS	P0090623		1-	
J 3013	CONNECTOR				SC25-02WS	P0090621		1-	
J 3014	CONNECTOR				SG8035#01	P1090350		1-	
J 3015	CONNECTOR				16FMZ-BT	P1090902		1-	
J 3016	CONNECTOR				JPJ2545-01-510	P1090633		1-	
J 3017	CONNECTOR				SC25-02WS	P0090621		1-	
J 3018	CONNECTOR				SC25-04WS	P0090623		1-	
J 3019	CONNECTOR				HSJ0916-01-010	P1090546		1-	
J 3020	CONNECTOR				JPJ2545-01-510	P1090633		1-	
J 3021	CONNECTOR				TCS5073-14-4151	P1090645		1-	
J 3022	CONNECTOR				SC25-06WS	P0090625		1-	
J 3023	CONNECTOR				TCS5073-15-4151	P1090646		1-	
J 3024	CONNECTOR				12FMZ-BT	P1090901		1-	
J 3025	CONNECTOR				TCS5073-17-4151	P1090648		1-	
J 3026	CONNECTOR				SC25-02WS	P0090621.		1-	
J 3028	CONNECTOR				16FMZ-BT	P1090902		1-	
J 3029	CONNECTOR				16FMZ-BT	P1090902		1-	
J 3031	CONNECTOR				SC25-02WS	P0090621		1-	
J 3032	CONNECTOR				SC25-02WS	P0090621		1-	
J 3033	CONNECTOR				SC25-05WS	P0090624		1-	
J 3034	CONNECTOR				JPJ2545-01-510	P1090633		1-	
J 3035	CONNECTOR				SC25-03WS	P0090622		1-	
J 3036	CONNECTOR				SC25-03WS	P0090622		1-	
J 3037	CONNECTOR				SC25-03WS	P0090622		1-	
J 3040	CONNECTOR				3022-05B	P0090594		1-	
J 3041	CONNECTOR				3022-06B	P0090473		1-	
JP3001	WIRE ASSY				A2720	T9206055		1-	
JP3003	WIRE ASSY				A2720	T9206055		1-	
JP3004	WIRE ASSY				BLK 75 <7>/<7>	T54007531		1-	
JP3005	WIRE ASSY				GRN 130 2/2	T50513000		1-	
L 3001	M.RFC	330uH			RCR-875D-331K	L1190393		1-	
L 3002	M.RFC	100uH			LAP02TA101K	L1790070		1-	
L 3003	M.RFC	1mH			LAL03TA102K	L1790119		1-	
L 3004	M.RFC	220uH			LAP02TA221K	L1790074		1-	

AF Unit

Parts List

REF.	DESCRIPTION	VALUE	V/W	TOL.	MFR'S DESIG	YAESU P/N	VERS.	LOT.	LAY ADR
L 3005	M.RFC	1mH			LAL03VB102K	L1790164		1-	
L 3006	M.RFC	1mH			LAL03VB102K	L1790164		1-	
L 3007	M.RFC	4.7uH			LK1608 4R7K-T	L1690688	W/CE LABEL	29-	
Q 3001	IC				BU4066BF-E2	G1092593		1-	e3
Q 3002	FET				2SK160-T2B K6	G3801607F		1-	e1
Q 3003	IC				UPD4053BG-T2	G1091034		1-	g3
Q 3004	TRANSISTOR				2SC2812L6-TA	G3328127F		1-	c3
Q 3004	TRANSISTOR				2SC2812NL6-TB	G3328128F		8-	c3
Q 3005	IC				M51131L	G1091077		1-	C2
Q 3005	IC				M51132L	G1093359		18-	C2
Q 3006	TRANSISTOR				2SC2812L6-TA	G3328127F		1-	e2
Q 3006	TRANSISTOR				2SC2812NL6-TB	G3328128F		8-	e2
Q 3007	IC				UPC1037H	G1090101		1-	D3
Q 3008	IC				M5218AFP-600C	G1091607		1-	e3
Q 3008	IC				NJM4558M(TE1)	G1093334		5-	e3
Q 3009	TRANSISTOR				2SC2812L6-TA	G3328127F		1-	d3
Q 3009	TRANSISTOR				2SC2812NL6-TB	G3328128F		8-	d3
Q 3010	TRANSISTOR				2SC4047-TA	G3340477		1-	e2
Q 3010	TRANSISTOR				UN2214-(TX)	G3070206		8-	e2
Q 3011	TRANSISTOR				2SC4047-TA	G3340477		1-	e2
Q 3011	TRANSISTOR				UN2214-(TX)	G3070206		8-	e2
Q 3013	IC				M5218AFP-600C	G1091607		1-	e3
Q 3013	IC				NJM4558M(TE1)	G1093334		5-	e3
Q 3014	IC				M5218AFP-600C	G1091607		1-	c1
Q 3014	IC				NJM4558M(TE1)	G1093334		5-	c1
Q 3015	IC				M5216FP-600C	G1091784		1-	d1
Q 3016	TRANSISTOR				2SC2812L6-TA	G3328127F		1-	d3
Q 3016	TRANSISTOR				2SC2812NL6-TB	G3328128F		8-	d3
Q 3017	IC				TC4W66F TE12L	G1091493		1-	c2
Q 3018	TRANSISTOR				2SC3444-T11-1E	G3334448E		1-	b2
Q 3018	TRANSISTOR				2SD2403GY-T1	G3424038Y		9-	b2
Q 3019	TRANSISTOR				2SC4047-TA	G3340477		1-	b1
Q 3019	TRANSISTOR				UN2214-(TX)	G3070206		8-	b1
Q 3020	TRANSISTOR				2SC2812L6-TA	G3328127F		1-	c3
Q 3020	TRANSISTOR				2SC2812NL6-TB	G3328128F		8-	c3
Q 3021	TRANSISTOR				2SC2812L6-TA	G3328127F		1-	b2
Q 3021	TRANSISTOR				2SC2812NL6-TB	G3328128F		8-	E1
Q 3022	IC				TDA2003	G1090769		1-	f2
Q 3023	IC				BU4066BF-E2	G1092593		1-	a3
Q 3024	IC				M5218AFP-600C	G1091607		1-	a2
Q 3024	IC				NJM4558M(TE1)	G1093334		5-	a2
Q 3025	TRANSISTOR				2SC2812L6-TA	G3328127F		1-	a2
Q 3025	TRANSISTOR				2SC2812NL6-TB	G3328128F		8-	a2
Q 3026	IC				M5218AFP-600C	G1091607		1-	a2
Q 3026	IC				NJM4558M(TE1)	G1093334		5-	a2
Q 3028	TRANSISTOR				2SC2812L6-TA	G3328127F		1-	d1
Q 3028	TRANSISTOR				2SC2812NL6-TB	G3328128F		8-	d1
Q 3029	TRANSISTOR				2SC2812L6-TA	G3328127F		1-	d2
Q 3029	TRANSISTOR				2SC2812NL6-TB	G3328128F		8-	d2
Q 3030	IC				M5218AFP-600C	G1091607		1-	b2
Q 3030	IC				NJM4558M(TE1)	G1093334		5-	b2
Q 3032	TRANSISTOR				2SC2812L6-TA	G3328127F		1-	d1
Q 3032	TRANSISTOR				2SC2812NL6-TB	G3328128F		8-	d1
Q 3033	TRANSISTOR				2SC2812L6-TA	G3328127F		1-	d2
Q 3033	TRANSISTOR				2SC2812NL6-TB	G3328128F		8-	d2
Q 3034	TRANSISTOR				2SC4047-TA	G3340477		1-	g4
Q 3034	TRANSISTOR				UN2214-(TX)	G3070206		8-	g4
Q 3035	TRANSISTOR				2SC4047-TA	G3340477		1-	g5
Q 3035	TRANSISTOR				UN2214-(TX)	G3070206		8-	g5
Q 3036	TRANSISTOR				2SC4047-TA	G3340477		1-	a2
Q 3036	TRANSISTOR				UN2214-(TX)	G3070206		8-	a2
Q 3037	TRANSISTOR				2SC2812L6-TA	G3328127F		1-	e1
Q 3037	TRANSISTOR				2SC2812NL6-TB	G3328128F		8-	e1
Q 3038	TRANSISTOR				2SC2812L6-TA	G3328127F		1-	e1
Q 3038	TRANSISTOR				2SC2812NL6-TB	G3328128F		8-	e1
Q 3039	TRANSISTOR				2SC2812L6-TA	G3328127F		1-	f1
Q 3040	IC				M5223AFP 600C	G1092955		1-	e4
Q 3042	IC				TC4W66F TE12L	G1091493		1-	f2

AF Unit

Parts List

REF.	DESCRIPTION	VALUE	V/W	TOL.	MFR'S DESIG	YAESU P/N	VERS.	LOT.	LAYADR
Q 3043	TRANSISTOR				2SC2812L6-TA	G3328127F		1-	c4
Q 3043	TRANSISTOR				2SC2812NL6-TB	G3328128F		8-	c4
Q 3044	C				M51131L	G1091077		1-	F4
Q 3044	C				M51132L	G1093359		18-	F4
Q 3045	TRANSISTOR				2SC2812L6-TA	G3328127F		1-	b4
Q 3045	TRANSISTOR				2SC2812NL6-TB	G3328128F		8-	b4
Q 3046	C				UPC1037H	G1090101		1-	E4
Q 3047	TRANSISTOR				2SC4047-TA	G3340477		1-	a4
Q 3047	TRANSISTOR				UN2214-(TX)	G3070206		8-	a4
Q 3048	TRANSISTOR				2SC2812L6-TA	G3328127F		1-	a4
Q 3048	TRANSISTOR				2SC2812NL6-TB	G3328128F		8-	a4
Q 3049	TRANSISTOR				2SC2812L6-TA	G3328127F		1-	c4
Q 3049	TRANSISTOR				2SC2812NL6-TB	G3328128F		8-	c4
Q 3050	TRANSISTOR				2SC4047-TA	G3340477		1-	b4
Q 3050	TRANSISTOR				UN2214-(TX)	G3070206		8-	b4
Q 3052	C				M5223AFP 600C	G1092955		1-	f4
Q 3053	C				M5223AFP 600C	G1092955		1-	g4
Q 3054	C				TC4W66F TE12L	G1091493		1-	f3
Q 3055	TRANSISTOR				2SC4047-TA	G3340477		1-	f3
Q 3055	TRANSISTOR				UN2214-(TX)	G3070206		8-	f3
Q 3056	C				M5218AFP-600C	G1091607		1-	a1
Q 3056	C				NJM4558M(TE1)	G1093334		5-	a1
Q 3058	TRANSISTOR				2SC4047-TA	G3340477		1-	a2
Q 3058	TRANSISTOR				UN2214-(TX)	G3070206		8-	a2
Q 3059	TRANSISTOR				DTA114EK T146	G3070047		1-	a2
Q 3060	TRANSISTOR				DTA114EK T146	G3070047		1-	a2
Q 3061	TRANSISTOR				2SC2812L6-TA	G3328127F		1-	g1
Q 3061	TRANSISTOR				2SC2812NL6-TB	G3328128F		8-	g1
Q 3062	C				TC4S66F TE85R	G1090893		1-	f3
Q 3063	TRANSISTOR				2SC2812L6-TA	G3328127F		1-	g2
Q 3063	TRANSISTOR				2SC2812NL6-TB	G3328128F		8-	g2
Q 3064	TRANSISTOR				2SC2812L6-TA	G3328127F		1-	f1
Q 3066	C				M5218AFP-600C	G1091607		1-	b1
Q 3066	C				NJM4558M(TE1)	G1093334		5-	b1
Q 3067	C				TC4S66F TE85R	G1090893		1-	g3
Q 3068	TRANSISTOR				2SC4047-TA	G3340477		1-	a4
Q 3068	TRANSISTOR				UN2214-(TX)	G3070206		8-	a4
Q 3069	TRANSISTOR				2SC4047-TA	G3340477		1-	f5
Q 3069	TRANSISTOR				UN2214-(TX)	G3070206		8-	f5
Q 3070	TRANSISTOR				2SC4047-TA	G3340477		1-	f4
Q 3070	TRANSISTOR				UN2214-(TX)	G3070206		8-	f4
Q 3071	FET				2SK209GR TE85R	G3802097G		1-	c3
Q 3072	FET				2SK209GR TE85R	G3802097G		1-	c4
R 3001	CHIPRES.	100	1/10W	5%	RMC1/10T 101J	J24205101		1-	
R 3002	CHIPRES.	100	1/10W	5%	RMC1/10T 101J	J24205101		1-	
R 3003	CHIPRES.	68k	1/10W	5%	RMC1/10T 683J	J24205683		1-	
R 3004	CHIPRES.	68k	1/10W	5%	RMC1/10T 683J	J24205683		1-	
R 3005	CHIPRES.	47k	1/10W	5%	RMC1/10T 473J	J24205473		1-	
R 3006	CHIPRES.	100k	1/10W	5%	RMC1/10T 104J	J24205104		1-	
R 3007	CHIPRES.	3.3k	1/10W	5%	RMC1/10T 332J	J24205332		1-	
R 3008	CHIPRES.	100	1/10W	5%	RMC1/10T 101J	J24205101		1-	
R 3009	CHIPRES.	47k	1/10W	5%	RMC1/10T 473J	J24205473		1-	
R 3011	CHIPRES.	100k	1/10W	5%	RMC1/10T 104J	J24205104		1-	
R 3012	CHIPRES.	150	1/10W	5%	RMC1/10T 151J	J24205151		1-	
R 3013	CHIPRES.	4.7k	1/10W	5%	RMC1/10T 472J	J24205472		1-	
R 3014	CHIPRES.	68k	1/10W	5%	RMC1/10T 683J	J24205683		1-	
R 3015	CHIPRES.	150k	1/10W	5%	RMC1/10T 154J	J24205154		1-	
R 3016	CHIPRES.	10k	1/10W	5%	RMC1/10T 103J	J24205103		1-	
R 3017	CHIPRES.	10k	1/10W	5%	RMC1/10T 103J	J24205103		1-	
R 3018	CHIPRES.	12k	1/10W	5%	RMC1/10T 123J	J24205123		1-	
R 3019	CHIPRES.	12k	1/10W	5%	RMC1/10T 123J	J24205123		1-	
R 3020	CHIPRES.	10k	1/10W	5%	RMC1/10T 103J	J24205103		1-	
R 3021	CHIPRES.	10k	1/10W	5%	RMC1/10T 103J	J24205103		1-	
R 3022	CHIPRES.	1k	1/10W	5%	RMC1/10T 102J	J24205102		1-	
R 3023	CHIPRES.	22k	1/10W	5%	RMC1/10T 223J	J24205223		1-	
R 3024	CHIPRES.	100k	1/10W	5%	RMC1/10T 104J	J24205104		1-	
R 3025	CHIPRES.	100	1/10W	5%	RMC1/10T 101J	J24205101		1-	
R 3026	CHIPRES.	1k	1/10W	5%	RMC1/10T 102J	J24205102		1-	

AF Unit

Parts List

REF.	DESCRIPTION	VALUE	V/W	TOL.	MFR'S DESIG	YAESU P/N	VERS.	LOT.	LAY ADR
R 3027	CHIPRES.	1k	1/10W	5%	RMC1/10T 102J	J24205102		1-	
R 3028	CHIPRES.	1k	1/10W	5%	RMC1/10T 102J	J24205102		1-	
R 3029	CHIPRES.	47k	1/10W	5%	RMC1/10T 473J	J24205473		1-	
R 3030	CHIPRES.	220	1/10W	5%	RMC1/10T 221J	J24205221		1-	
R 3031	CHIPRES.	100	1/10W	5%	RMC1/10T 101J	J24205101		1-	
R 3032	CHIPRES.	1k	1/10W	5%	RMC1/10T 102J	J24205102		1-	
R 3033	CHIPRES.	47k	1/10W	5%	RMC1/10T 473J	J24205473		1-	
R 3034	CHIPRES.	56	1/10W	5%	RMC1/10T 560J	J24205560		1-	
R 3035	CHIPRES.	47k	1/10W	5%	RMC1/10T 473J	J24205473		1-	
R 3036	CHIPRES.	1k	1/10W	5%	RMC1/10T 102J	J24205102		1-	
R 3037	CHIPRES.	180	1/10W	5%	RMC1/10T 181J	J24205181		1-	
R 3038	CHIPRES.	470	1/10W	5%	RMC1/10T 471J	J24205471		1-	
R 3039	CHIPRES.	1k	1/10W	5%	RMC1/10T 102J	J24205102		1-	
R 3040	CHIPRES.	10k	1/10W	5%	RMC1/10T 103J	J24205103		1-	
R 3041	CHIPRES.	47k	1/10W	5%	RMC1/10T 473J	J24205473		1-	
R 3042	CHIPRES.	220k	1/10W	5%	RMC1/10T 224J	J24205224		1-	
R 3043	CHIPRES.	100	1/10W	5%	RMC1/10T 101J	J24205101		1-	
R 3044	CHIPRES.	10k	1/10W	5%	RMC1/10T 103J	J24205103		1-	
R 3045	CHIPRES.	1k	1/10W	5%	RMC1/10T 102J	J24205102		1-	
R 3046	CHIPRES.	10k	1/10W	5%	RMC1/10T 103J	J24205103		1-	
R 3047	CHIPRES.	47k	1/10W	5%	RMC1/10T 473J	J24205473		1-	
R 3048	CHIPRES.	10k	1/10W	5%	RMC1/10T 103J	J24205103		1-	
R 3049	CHIPRES.	100k	1/10W	5%	RMC1/10T 104J	J24205104		1-	
R 3050	CHIPRES.	1k	1/10W	5%	RMC1/10T 102J	J24205102		1-	
R 3051	CHIPRES.	47	1/10W	5%	RMC1/10T 470J	J24205470		1-	
R 3052	CHIPRES.	47k	1/10W	5%	RMC1/10T 473J	J24205473		1-	
R 3053	CHIPRES.	220k	1/10W	5%	RMC1/10T 224J	J24205224		1-	
R 3054	CHIPRES.	470	1/10W	5%	RMC1/10T 471J	J24205471		1-	
R 3055	CHIPRES.	100k	1/10W	5%	RMC1/10T 104J	J24205104		1-	
R 3056	CHIPRES.	10k	1/10W	5%	RMC1/10T 103J	J24205103		1-	
R 3057	CHIPRES.	10k	1/10W	5%	RMC1/10T 103J	J24205103		1-	
R 3058	CHIPRES.	1k	1/10W	5%	RMC1/10T 102J	J24205102		1-	
R 3059	CHIPRES.	1k	1/10W	5%	RMC1/10T 102J	J24205102		1-	
R 3060	CHIPRES.	27k	1/10W	5%	RMC1/10T 273J	J24205273		1-	
R 3061	CHIPRES.	1k	1/10W	5%	RMC1/10T 102J	J24205102		1-	
R 3062	CHIPRES.	1k	1/10W	5%	RMC1/10T 102J	J24205102		1-	
R 3063	CHIPRES.	470	1/10W	5%	RMC1/10T 471J	J24205471		1-	
R 3065	CHIPRES.	100k	1/10W	5%	RMC1/10T 104J	J24205104		1-	
R 3066	CHIPRES.	270	1/10W	5%	RMC1/10T 271J	J24205271		1-	
R 3067	CHIPRES.	2.2k	1/10W	5%	RMC1/10T 222J	J24205222		1-	
R 3068	CHIPRES.	470	1/10W	5%	RMC1/10T 471J	J24205471		1-	
R 3069	CHIPRES.	470	1/10W	5%	RMC1/10T 471J	J24205471		1-	
R 3070	CARBON FILM RES.	270	1/6W	5%	RD16TPJ271 270	J07225271		1-	
R 3072	CHIPRES.	10k	1/10W	5%	RMC1/10T 103J	J24205103		1-	
R 3073	CHIPRES.	1k	1/10W	5%	RMC1/10T 102J	J24205102		1-	
R 3074	CARBON FILM RES.	2.2	1/6W	5%	RD16TPJ2R2 2.2	J07225229		1-	
R 3075	CHIPRES.	4.7k	1/10W	5%	RMC1/10T 472J	J24205472		1-	
R 3076	CHIPRES.	4.7k	1/10W	5%	RMC1/10T 472J	J24205472		1-	
R 3077	CHIPRES.	100k	1/10W	5%	RMC1/10T 104J	J24205104		1-	
R 3078	CHIPRES.	150k	1/10W	5%	RMC1/10T 154J	J24205154		1-	
R 3079	CHIPRES.	0	1/10W	5%	RMC1/10T 000J	J24205000		1-	
R 3080	CHIPRES.	10k	1/10W	5%	RMC1/10T 103J	J24205103		1-	
R 3081	CHIPRES.	100k	1/10W	5%	RMC1/10T 104J	J24205104		1-	
R 3082	CHIPRES.	3.3k	1/10W	5%	RMC1/10T 332J	J24205332		1-	
R 3083	CHIPRES.	1M	1/10W	5%	RMC1/10T 105J	J24205105		1-	
R 3084	CHIPRES.	22k	1/10W	5%	RMC1/10T 223J	J24205223		1-	
R 3085	CHIPRES.	150k	1/10W	5%	RMC1/10T 154J	J24205154		1-	
R 3086	CHIPRES.	150k	1/10W	5%	RMC1/10T 154J	J24205154		1-	
R 3087	CHIPRES.	10k	1/10W	5%	RMC1/10T 103J	J24205103		1-	
R 3088	CHIPRES.	3.3k	1/10W	5%	RMC1/10T 332J	J24205332		1-	
R 3089	CHIPRES.	2.2k	1/10W	5%	RMC1/10T 222J	J24205222		1-	
R 3090	CHIPRES.	100k	1/10W	5%	RMC1/10T 104J	J24205104		1-	
R 3091	CHIPRES.	3.9k	1/10W	5%	RMC1/10T 392J	J24205392		1-	
R 3092	CHIPRES.	33k	1/10W	5%	RMC1/10T 333J	J24205333		1-	
R 3094	CHIPRES.	47k	1/10W	5%	RMC1/10T 473J	J24205473		1-	
R 3095	CHIPRES.	47k	1/10W	5%	RMC1/10T 473J	J24205473		1-	
R 3096	CHIPRES.	100	1/10W	5%	RMC1/10T 101J	J24205101		1-	
R 3097	CHIPRES.	100	1/10W	5%	RMC1/10T 101J	J24205101		1-	

AF Unit

Parts List

REF.	DESCRIPTION	VALUE	V/W	TOL.	MFR'S DESIG	YAESU P/N	VERS.	LOT.	LAY ADR
R 3098	CHIPRES.	10k	1/10W	5%	RMC1/10T 103J	J24205103		1-	
R 3099	CHIPRES.	100k	1/10W	5%	RMC1/10T 104J	J24205104		1-	
R 3100	CHIPRES.	47k	1/10W	5%	RMC1/10T 473J	J24205473		1-	
R 3101	CHIPRES.	100k	1/10W	5%	RMC1/10T 104J	J24205104		1-	
R 3102	CHIPRES.	1k	1/10W	5%	RMC1/10T 102J	J24205102		1-	
R 3104	CHIPRES.	22k	1/10W	5%	RMC1/10T 223J	J24205223		1-	
R 3105	CHIPRES.	150k	1/10W	5%	RMC1/10T 154J	J24205154		1-	
R 3106	CHIPRES.	150k	1/10W	5%	RMC1/10T 154J	J24205154		1-	
R 3107	CHIPRES.	100k	1/10W	5%	RMC1/10T 104J	J24205104		1-	
R 3108	CHIPRES.	33k	1/10W	5%	RMC1/10T 333J	J24205333		1-	
R 3109	CHIPRES.	2.2k	1/10W	5%	RMC1/10T 222J	J24205222		1-	
R 3110	CHIPRES.	180k	1/10W	5%	RMC1/10T 184J	J24205184		1-	
R 3111	CHIPRES.	47k	1/10W	5%	RMC1/10T 473J	J24205473		1-	
R 3112	CHIPRES.	47k	1/10W	5%	RMC1/10T 473J	J24205473		1-	
R 3114	CHIPRES.	47k	1/10W	5%	RMC1/10T 473J	J24205473		1-	
R 3115	CHIPRES.	100k	1/10W	5%	RMC1/10T 104J	J24205104		1-	
R 3117	CHIPRES.	47k	1/10W	5%	RMC1/10T 473J	J24205473		1-	
R 3118	CHIPRES.	1k	1/10W	5%	RMC1/10T 102J	J24205102		1-	
R 3119	CHIPRES.	1k	1/10W	5%	RMC1/10T 102J	J24205102		1-	
R 3122	CHIPRES.	180k	1/10W	5%	RMC1/10T 184J	J24205184		1-	
R 3124	CHIPRES.	100k	1/10W	5%	RMC1/10T 104J	J24205104		1-	
R 3127	CHIPRES.	100k	1/10W	5%	RMC1/10T 104J	J24205104		1-	
R 3128	CHIPRES.	33k	1/10W	5%	RMC1/10T 333J	J24205333		1-	
R 3129	CHIPRES.	47k	1/10W	5%	RMC1/10T 473J	J24205473		1-	
R 3130	CHIPRES.	47k	1/10W	5%	RMC1/10T 473J	J24205473		1-	
R 3131	CHIPRES.	47k	1/10W	5%	RMC1/10T 473J	J24205473		1-	
R 3135	CHIPRES.	1k	1/10W	5%	RMC1/10T 102J	J24205102		1-	
R 3136	CHIPRES.	1k	1/10W	5%	RMC1/10T 102J	J24205102		1-	
R 3137	CHIPRES.	0	1/10W	5%	RMC1/10T 000J	J24205000		1-	
R 3138	CHIPRES.	68k	1/10W	5%	RMC1/10T 683J	J24205683		1-	
R 3139	CHIPRES.	100	1/10W	5%	RMC1/10T 101J	J24205101		1-	
R 3140	CHIPRES.	100k	1/10W	5%	RMC1/10T 104J	J24205104		1-	
R 3141	CHIPRES.	33k	1/10W	5%	RMC1/10T 333J	J24205333		1-	
R 3142	CHIPRES.	3.3k	1/10W	5%	RMC1/10T 332J	J24205332		1-	
R 3143	CHIPRES.	10k	1/10W	5%	RMC1/10T 103J	J24205103		1-	
R 3144	CHIPRES.	1k	1/10W	5%	RMC1/10T 102J	J24205102		1-	
R 3145	CHIPRES.	1k	1/10W	5%	RMC1/10T 102J	J24205102		1-	
R 3146	CHIPRES.	47k	1/10W	5%	RMC1/10T 473J	J24205473		1-	
R 3147	CHIPRES.	100k	1/10W	5%	RMC1/10T 104J	J24205104		1-	
R 3148	CHIPRES.	100k	1/10W	5%	RMC1/10T 104J	J24205104		1-	
R 3149	CHIPRES.	33k	1/10W	5%	RMC1/10T 333J	J24205333		1-	
R 3150	CHIPRES.	1k	1/10W	5%	RMC1/10T 102J	J24205102		1-	
R 3151	CHIPRES.	100k	1/10W	5%	RMC1/10T 104J	J24205104		1-	
R 3152	CHIPRES.	100k	1/10W	5%	RMC1/10T 104J	J24205104		1-	
R 3153	CHIPRES.	3.3k	1/10W	5%	RMC1/10T 332J	J24205332		1-	
R 3155	CHIPRES.	10k	1/10W	5%	RMC1/10T 103J	J24205103		1-	
R 3158	CHIPRES.	100	1/10W	5%	RMC1/10T 101J	J24205101		1-	
R 3160	CHIPRES.	3.3k	1/10W	5%	RMC1/10T 332J	J24205332		1-	
R 3161	CHIPRES.	47k	1/10W	5%	RMC1/10T 473J	J24205473		1-	
R 3162	CHIPRES.	100	1/10W	5%	RMC1/10T 101J	J24205101		1-	
R 3163	CHIPRES.	22k	1/10W	5%	RMC1/10T 223J	J24205223		1-	
R 3164	CHIPRES.	470	1/10W	5%	RMC1/10T 471J	J24205471		1-	
R 3166	CHIPRES.	100	1/10W	5%	RMC1/10T 101J	J24205101		1-	
R 3167	CHIPRES.	100	1/10W	5%	RMC1/10T 101J	J24205101		1-	
R 3169	CHIPRES.	2.2k	1/10W	5%	RMC1/10T 222J	J24205222		1-	
R 3170	CHIPRES.	18k	1/10W	5%	RMC1/10T 183J	J24205183		1-	
R 3171	CHIPRES.	100k	1/10W	5%	RMC1/10T 104J	J24205104		1-	
R 3172	CHIPRES.	68k	1/10W	5%	RMC1/10T 683J	J24205683		1-	
R 3173	CHIPRES.	180	1/10W	5%	RMC1/10T 181J	J24205181		1-	
R 3174	CHIPRES.	22k	1/10W	5%	RMC1/10T 223J	J24205223		1-	
R 3176	CHIPRES.	220	1/10W	5%	RMC1/10T 221J	J24205221		1-	
R 3177	CHIPRES.	10k	1/10W	5%	RMC1/10T 103J	J24205103		1-	
R 3178	CHIPRES.	3.3k	1/10W	5%	RMC1/10T 332J	J24205332		1-	
R 3179	CHIPRES.	4.7k	1/10W	5%	RMC1/10T 472J	J24205472		1-	
R 3181	CHIPRES.	150	1/10W	5%	RMC1/10T 151J	J24205151		1-	
R 3182	CHIPRES.	3.3M	1/10W	5%	RMC1/10T 335J	J24205335		1-	
R 3183	CHIPRES.	10k	1/10W	5%	RMC1/10T 103J	J24205103		1-	
R 3184	CHIPRES.	2.2k	1/10W	5%	RMC1/10T 222J	J24205222		1-	

AF Unit

Parts List

REF.	DESCRIPTION	VALUE	V/W	TOL.	MFR'S DESIG	YAESU P/N	VERS.	LOT.	LAY ADR
R 3186	CHIPRES.	1k	1/10W	5%	RMC1/10T 102J	J24205102		1-	
R 3187	CHIPRES.	82	1/10W	5%	RMC1/10T 820J	J24205820		1-	
R 3189	CHIPRES.	47k	1/10W	5%	RMC1/10T 473J	J24205473		1-	
R 3190	CHIPRES.	100k	1/10W	5%	RMC1/10T 104J	J24205104		1-	
R 3191	CHIPRES.	4.7k	1/10W	5%	RMC1/10T 472J	J24205472		1-	
R 3192	CHIPRES.	10k	1/10W	5%	RMC1/10T 103J	J24205103		1-	
R 3193	CHIPRES.	2.2k	1/10W	5%	RMC1/10T 222J	J24205222		1-	
R 3194	CHIPRES.	2.2k	1/10W	5%	RMC1/10T 222J	J24205222		1-	
R 3195	CHIPRES.	220	1/10W	5%	RMC1/10T 221J	J24205221		1-	
R 3196	CHIPRES.	330	1/10W	5%	RMC1/10T 331J	J24205331		1-	
R 3197	CHIPRES.	180	1/10W	5%	RMC1/10T 181J	J24205181		1-	
R 3198	CHIPRES.	1k	1/10W	5%	RMC1/10T 102J	J24205102		1-	
R 3199	CHIPRES.	470	1/10W	5%	RMC1/10T 471J	J24205471		1-	
R 3201	CHIPRES.	4.7k	1/10W	5%	RMC1/10T 472J	J24205472		1-	
R 3202	CHIPRES.	470	1/10W	5%	RMC1/10T 471J	J24205471		1-	
R 3203	CHIPRES.	1k	1/10W	5%	RMC1/10T 102J	J24205102		1-	
R 3204	CHIPRES.	47k	1/10W	5%	RMC1/10T 473J	J24205473		1-	
R 3205	CHIPRES.	1k	1/10W	5%	RMC1/10T 102J	J24205102		1-	
R 3206	CHIPRES.	470k	1/10W	5%	RMC1/10T 474J	J24205474		1-	
R 3207	CHIPRES.	100k	1/10W	5%	RMC1/10T 104J	J24205104		1-	
R 3208	CHIPRES.	10k	1/10W	5%	RMC1/10T 103J	J24205103		1-	
R 3209	CHIPRES.	220	1/10W	5%	RMC1/10T 221J	J24205221		1-	
R 3210	CHIPRES.	100k	1/10W	5%	RMC1/10T 104J	J24205104		1-	
R 3211	CHIPRES.	15k	1/10W	5%	RMC1/10T 153J	J24205153		1-	
R 3212	CHIPRES.	1k	1/10W	5%	RMC1/10T 102J	J24205102		1-	
R 3213	CHIPRES.	330k	1/10W	5%	RMC1/10T 334J	J24205334		1-	
R 3214	CHIPRES.	2.2k	1/10W	5%	RMC1/10T 222J	J24205222		1-	
R 3215	CHIPRES.	10k	1/10W	5%	RMC1/10T 103J	J24205103		1-	
R 3216	CHIPRES.	2.2k	1/10W	5%	RMC1/10T 222J	J24205222		1-	
R 3217	CHIPRES.	4.7k	1/10W	5%	RMC1/10T 472J	J24205472		1-	
R 3218	CHIPRES.	10k	1/10W	5%	RMC1/10T 103J	J24205103		1-	
R 3219	CHIPRES.	10k	1/10W	5%	RMC1/10T 103J	J24205103		1-	
R 3220	CHIPRES.	470k	1/10W	5%	RMC1/10T 474J	J24205474		1-	
R 3221	CHIPRES.	10k	1/10W	5%	RMC1/10T 103J	J24205103		1-	
R 3222	CHIPRES.	10k	1/10W	5%	RMC1/10T 103J	J24205103		1-	
R 3223	CHIPRES.	1k	1/10W	5%	RMC1/10T 102J	J24205102		1-	
R 3224	CHIPRES.	1k	1/10W	5%	RMC1/10T 102J	J24205102		1-	
R 3225	CHIPRES.	47k	1/10W	5%	RMC1/10T 473J	J24205473		1-	
R 3226	CHIPRES.	56k	1/10W	5%	RMC1/10T 563J	J24205563		1-	
R 3227	CHIPRES.	47k	1/10W	5%	RMC1/10T 473J	J24205473		1-	
R 3228	CHIPRES.	56k	1/10W	5%	RMC1/10T 563J	J24205563		1-	
R 3229	CHIPRES.	47k	1/10W	5%	RMC1/10T 473J	J24205473		1-	
R 3230	CHIPRES.	47k	1/10W	5%	RMC1/10T 473J	J24205473		1-	
R 3232	CARBON FILM RES.	1	1/6W	5%	RD16TPJ010 1	J07225010		1-	
R 3233	CHIPRES.	47k	1/10W	5%	RMC1/10T 473J	J24205473		1-	
R 3234	CHIPRES.	4.7k	1/10W	5%	RMC1/10T 472J	J24205472		1-	
R 3238	CHIPRES.	4.7k	1/10W	5%	RMC1/10T 472J	J24205472		1-	
R 3239	CHIPRES.	4.7k	1/10W	5%	RMC1/10T 472J	J24205472		1-	
R 3240	CHIPRES.	47k	1/10W	5%	RMC1/10T 473J	J24205473		1-	
R 3241	CHIPRES.	18k	1/10W	5%	RMC1/10T 183J	J24205183		1-	
R 3242	CHIPRES.	330	1/10W	5%	RMC1/10T 331J	J24205331		1-	
R 3243	CHIPRES.	680	1/10W	5%	RMC1/10T 681J	J24205681		1-	
R 3244	CHIPRES.	10k	1/10W	5%	RMC1/10T 103J	J24205103		1-	
R 3245	CHIPRES.	150k	1/10W	5%	RMC1/10T 154J	J24205154		1-	
R 3246	CHIPRES.	4.7k	1/10W	5%	RMC1/10T 472J	J24205472		1-	
R 3247	CHIPRES.	100k	1/10W	5%	RMC1/10T 104J	J24205104		1-	
R 3248	CHIPRES.	100k	1/10W	5%	RMC1/10T 104J	J24205104		1-	
R 3249	CHIPRES.	100k	1/10W	5%	RMC1/10T 104J	J24205104		1-	
R 3250	CHIPRES.	47k	1/10W	5%	RMC1/10T 473J	J24205473		1-	
R 3251	CHIPRES.	8.2k	1/10W	5%	RMC1/10T 822J	J24205822		1-	
R 3252	CHIPRES.	100k	1/10W	5%	RMC1/10T 104J	J24205104		1-	
R 3253	CHIPRES.	10k	1/10W	5%	RMC1/10T 103J	J24205103		1-	
R 3254	CHIPRES.	27k	1/10W	5%	RMC1/10T 273J	J24205273		1-	
R 3255	CHIPRES.	270	1/10W	5%	RMC1/10T 271J	J24205271		1-	
R 3256	CHIPRES.	1k	1/10W	5%	RMC1/10T 102J	J24205102		1-	
R 3257	CHIPRES.	1k	1/10W	5%	RMC1/10T 102J	J24205102		1-	
R 3258	CHIPRES.	100k	1/10W	5%	RMC1/10T 104J	J24205104		1-	
R 3259	CHIPRES.	100	1/10W	5%	RMC1/10T 101J	J24205101		1-	

AF Unit

Parts List

REF.	DESCRIPTION	VALUE	V/W	TOL.	MFR'S DESIG	YAESU P/N	VERS.	LOT.	LAYADR
R 3260	CHIPRES.	47k	1/10W	5%	RMC1/10T 473J	J24205473		1-	
R 3261	CHIPRES.	47k	1/10W	5%	RMC1/10T 473J	J24205473		1-	
R 3262	CHIPRES.	10k	1/10W	5%	RMC1/10T 103J	J24205103		1-	
R 3264	CHIPRES.	100k	1/10W	5%	RMC1/10T 104J	J24205104		1-	
R 3265	CHIPRES.	10k	1/10W	5%	RMC1/10T 103J	J24205103		1-	
R 3266	CHIPRES.	10k	1/10W	5%	RMC1/10T 103J	J24205103		1-	
R 3267	CHIPRES.	10k	1/10W	5%	RMC1/10T 103J	J24205103		1-	
R 3268	CHIPRES.	120k	1/10W	5%	RMC1/10T 124J	J24205124		1-	
R 3269	CHIPRES.	47k	1/10W	5%	RMC1/10T 473J	J24205473		1-	
R 3270	CHIPRES.	10k	1/10W	5%	RMC1/10T 103J	J24205103		1-	
R 3272	CHIPRES.	100	1/10W	5%	RMC1/10T 101J	J24205101		1-	
R 3273	CHIPRES.	47k	1/10W	5%	RMC1/10T 473J	J24205473		1-	
R 3274	CHIPRES.	100k	1/10W	5%	RMC1/10T 104J	J24205104		1-	
R 3275	CHIPRES.	180	1/10W	5%	RMC1/10T 181J	J24205181		1-	
R 3276	CHIPRES.	47k	1/10W	5%	RMC1/10T 473J	J24205473		1-	
R 3277	CHIPRES.	47k	1/10W	5%	RMC1/10T 473J	J24205473		1-	
R 3278	CHIPRES.	47k	1/10W	5%	RMC1/10T 473J	J24205473		1-	
R 3279	CHIPRES.	0	1/10W	5%	RMC1/10T 000J	J24205000		1-	
R 3280	CHIPRES.	180	1/10W	5%	RMC1/10T 181J	J24205181		1-	
R 3281	CHIPRES.	100k	1/10W	5%	RMC1/10T 104J	J24205104		1-	
R 3282	CARBON FILM RES.	330	1/6W	5%	RD16TPJ331 330	J07225331		1-	
R 3283	CHIPRES.	100k	1/10W	5%	RMC1/10T 104J	J24205104		1-	
R 3284	CHIPRES.	100k	1/10W	5%	RMC1/10T 104J	J24205104		1-	
R 3285	CHIPRES.	100k	1/10W	5%	RMC1/10T 104J	J24205104		1-	
R 3286	CHIPRES.	100k	1/10W	5%	RMC1/10T 104J	J24205104		1-	
R 3287	CHIPRES.	1k	1/10W	5%	RMC1/10T 102J	J24205102		1-	
R 3288	CHIPRES.	1k	1/10W	5%	RMC1/10T 102J	J24205102		1-	
R 3289	CHIPRES.	3.3k	1/10W	5%	RMC1/10T 332J	J24205332		1-	
R 3290	CHIPRES.	2.7k	1/10W	5%	RMC1/10T 272J	J24205272		1-	
R 3291	CHIPRES.	3.3k	1/10W	5%	RMC1/10T 332J	J24205332		1-	
R 3292	CHIPRES.	2.7k	1/10W	5%	RMC1/10T 272J	J24205272		1-	
R 3293	CHIPRES.	2.2k	1/10W	5%	RMC1/10T 222J	J24205222		1-	
R 3294	CHIPRES.	1k	1/10W	5%	RMC1/10T 102J	J24205102		1-	
R 3295	CHIPRES.	10k	1/10W	5%	RMC1/10T 103J	J24205103		1-	
R 3296	CHIPRES.	1.5k	1/10W	5%	RMC1/10T 152J	J24205152		1-	
R 3297	CHIPRES.	6.8k	1/10W	5%	RMC1/10T 682J	J24205682		1-	
R 3298	CHIPRES.	10k	1/10W	5%	RMC1/10T 103J	J24205103		1-	
R 3299	CHIPRES.	470k	1/10W	5%	RMC1/10T 474J	J24205474		1-	
R 3300	CHIPRES.	470k	1/10W	5%	RMC1/10T 474J	J24205474		1-	
R 3301	CHIPRES.	47k	1/10W	5%	RMC1/10T 473J	J24205473		1-	
R 3302	CHIPRES.	4.7k	1/10W	5%	RMC1/10T 472J	J24205472		1-	
R 3303	CHIPRES.	1k	1/10W	5%	RMC1/10T 102J	J24205102		1-	
R 3304	CHIPRES.	10k	1/10W	5%	RMC1/10T 103J	J24205103		1-	
R 3305	CHIPRES.	2.2M	1/10W	5%	RMC1/10T 225J	J24205225		1-	
R 3306	CHIPRES.	10k	1/10W	5%	RMC1/10T 103J	J24205103		1-	
R 3307	CHIPRES.	1k	1/10W	5%	RMC1/10T 102J	J24205102		1-	
R 3308	CHIPRES.	1k	1/10W	5%	RMC1/10T 102J	J24205102		1-	
R 3309	CHIPRES.	4.7k	1/10W	5%	RMC1/10T 472J	J24205472		1-	
R 3310	CHIPRES.	4.7k	1/10W	5%	RMC1/10T 472J	J24205472		1-	
R 3311	CHIPRES.	10k	1/10W	5%	RMC1/10T 103J	J24205103		1-	
R 3314	CHIPRES.	1M	1/10W	5%	RMC1/10T 105J	J24205105		1-	
R 3315	CHIPRES.	10k	1/10W	5%	RMC1/10T 103J	J24205103		1-	
R 3316	CHIPRES.	10k	1/10W	5%	RMC1/10T 103J	J24205103		1-	
R 3317	CHIPRES.	68k	1/10W	5%	RMC1/10T 683J	J24205683		1-	
R 3318	CHIPRES.	1k	1/10W	5%	RMC1/10T 102J	J24205102		1-	
R 3319	CHIPRES.	100k	1/10W	5%	RMC1/10T 104J	J24205104		1-	
R 3320	CHIPRES.	10k	1/10W	5%	RMC1/10T 103J	J24205103		1-	
R 3321	CHIPRES.	100k	1/10W	5%	RMC1/10T 104J	J24205104		1-	
R 3322	CHIPRES.	47k	1/10W	5%	RMC1/10T 473J	J24205473		1-	
R 3323	CHIPRES.	0	1/10W	5%	RMC1/10T 000J	J24205000		1-	
R 3324	CHIPRES.	4.7k	1/10W	5%	RMC1/10T 472J	J24205472		1-	
R 3325	CHIPRES.	47k	1/10W	5%	RMC1/10T 473J	J24205473		1-	
R 3326	CHIPRES.	470k	1/10W	5%	RMC1/10T 474J	J24205474		1-	
R 3327	CHIPRES.	0	1/10W	5%	RMC1/10T 000J	J24205000		1-	
R 3328	CHIPRES.	0	1/10W	5%	RMC1/10T 000J	J24205000		1-	
R 3329	CHIPRES.	1k	1/10W	5%	RMC1/10T 102J	J24205102		1-	
RL3001	RELAY		DC12V		AG4013 DC12V	M1190090		1-	
S 3001	SLIDESWITCH				SSSS912N-2A-OR	N6090094		1-	

AF Unit

Parts List

REF.	DESCRIPTION	VALUE	V/W	TOL.	MFR'S DESIG	YAESU P/N	VERS.	LOT.	LAY ADR
S 3002	SLIDESWITCH				SSSS912N-2A-OR	N6090094		1-	
VR3001	POT.	10k			RH063MC14R 10KB	J51794103		1-	
VR3002	POT.	10k			RH063MC14R 10KB	J51794103		1-	
VR3003	POT.	10k			RH063MC14R 10KB	J51794103		1-	
VR3005	POT.	10k			RH063MC14R 10KB	J51794103		1-	
VR3006	POT.	2.2k			RH063MCJ3R 2.2KB	J51794222		1-	
VR3007	POT.	4.7k			RH063MCS3R 4.7KB	J51794472		1-	
VR3008	POT.	10k			RH063MC14R 10KB	J51794103		1-	
VR3009	POT.	10k			RH063MC14R 10KB	J51794103		1-	
VR3010	POT.	1k			RH063MC13R 1KB	J51794102		1-	
VR3011	POT.	10k			RH063MC14R 10KB	J51794103		1-	
VR3012	POT.	10k			RH063MC14R 10KB	J51794103		1-	
VR3013	POT.	10k			RH063MC14R 10KB	J51794103		1-	
VR3014	POT.	10k			RH063MC14R 10KB	J51794103		1-	
VR3015	POT.	10k			RH063MC14R 10KB	J51794103		1-	
Y 3001	THERMAL CONDUCTOR				45T-TO-220	Q9000548		1-	
	PLATE NUT					R0102810		1-	
	HEATSINK PLATE					R0132050		1-	
	CARD SPACER				WLS-04-0	S6000191		1-	
	SHIELD CASE COVER					R0131640		1-	

DDS-CAR Unit

Parts Layout

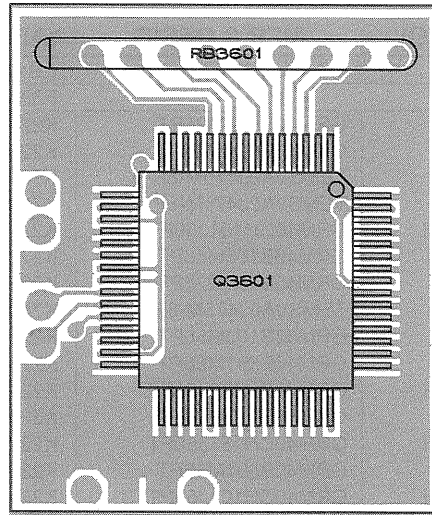

Side A

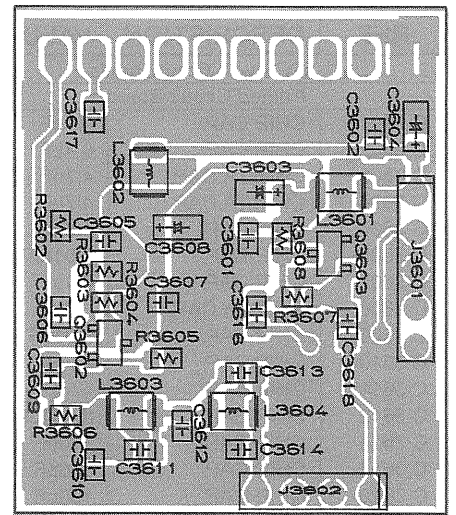

Side B

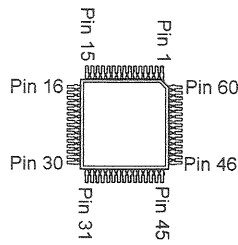

TC23SC030AF
(Q3601)

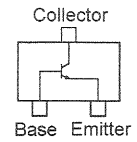

2SC2812 (L6)
(Q3602, 3603)

Circuit Diagram

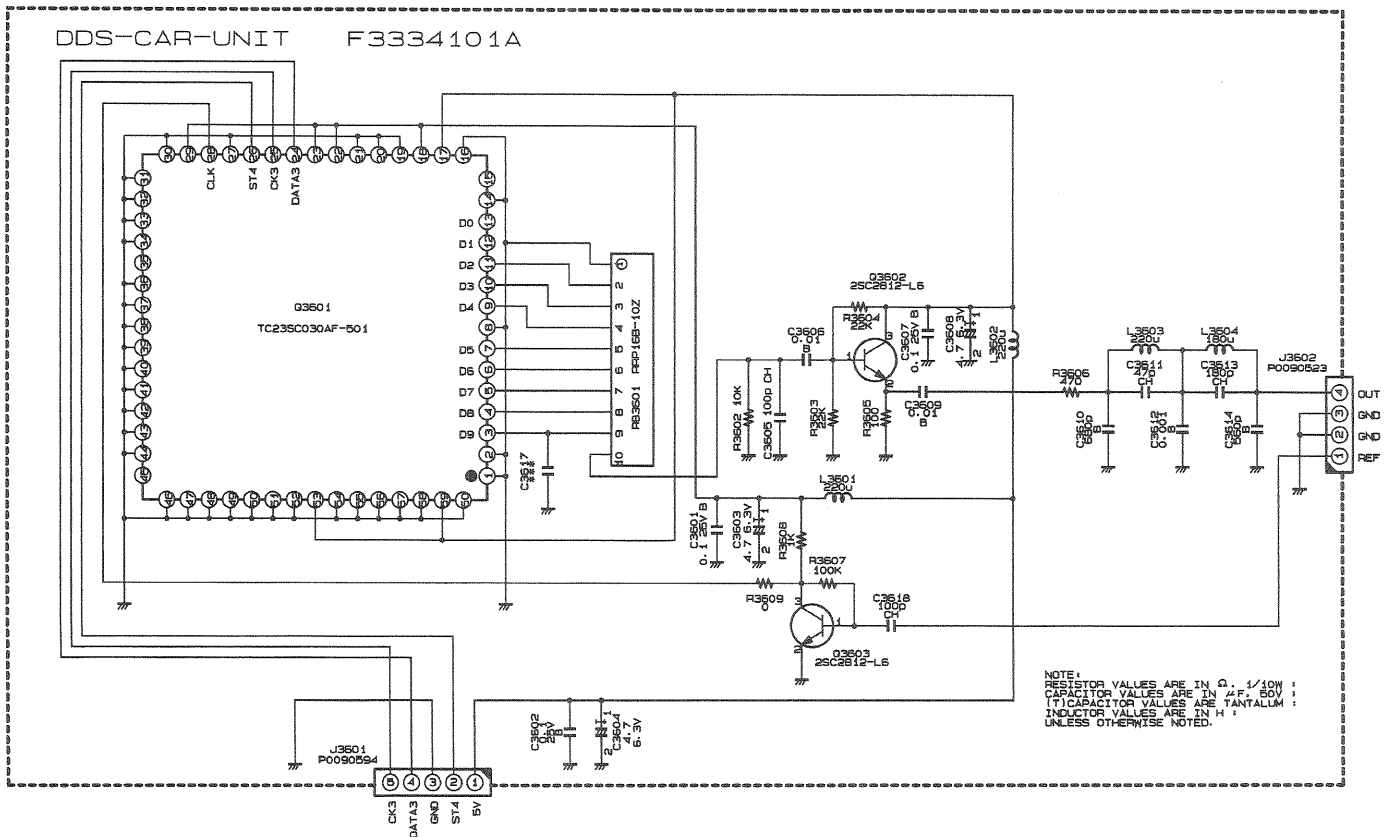

DDS-CAR Unit

Parts List

REF.	DESCRIPTION	VALUE	V/W	TOL.	MFR'S DESIG	YAESU P/N	VERS.	LOT.	LAYADR
PCB with Components						CB1190001			
Printed Circuit Board						F3334101A			
C 3601	CHIP CAP.	0.1uF	25V	B	GRM40B104M25PT	K22140811		1-	
C 3602	CHIP CAP.	0.1uF	25V	B	GRM40B104M25PT	K22140811		1-	
C 3603	CHIP TA.CAP.	4.7uF	6.3V		TEMSVA0J475M-8R	K78080017		1-	
C 3604	CHIP TA.CAP.	4.7uF	6.3V		TEMSVA0J475M-8R	K78080017		1-	
C 3605	CHIP CAP.	100pF	50V	CH	GRM40CH101J50PT	K22170235		1-	
C 3606	CHIP CAP.	0.01uF	50V	B	GRM40B103M50PT	K22170817		1-	
C 3607	CHIP CAP.	0.1uF	25V	B	GRM40B104M25PT	K22140811		1-	
C 3608	CHIP TA.CAP.	4.7uF	6.3V		TEMSVA0J475M-8R	K78080017		1-	
C 3609	CHIP CAP.	0.01uF	50V	B	GRM40B103M50PT	K22170817		1-	
C 3610	CHIP CAP.	680pF	50V	B	GRM40B681M50PT	K22170803		1-	
C 3611	CHIP CAP.	47pF	50V	CH	GRM40CH470J50PT	K22170227		1-	
C 3612	CHIP CAP.	0.001uF	50V	B	GRM40B102M50PT	K22170805		1-	
C 3613	CHIP CAP.	180pF	50V	CH	GRM40CH181J50PT	K22170241		1-	
C 3614	CHIP CAP.	560pF	50V	B	GRM40B561M50PT	K22170802		1-	
C 3618	CHIP CAP.	100pF	50V	CH	GRM40CH101J50PT	K22170235		1-	
C 3619	CERAMIC CAP.	10pF	50V	CH	UP050CH100J-A-B	K28179055		25-	
J 3601	CONNECTOR				3022-05B	P0090594		1-	
J 3602	CONNECTOR				3022-04B	P0090523		1-	
L 3601	M.RFC	220uH			FLC32T-221J	L1690231		1-	
L 3602	M.RFC	220uH			FLC32T-221J	L1690231		1-	
L 3603	M.RFC	220uH			FLC32T-221J	L1690231		1-	
L 3604	M.RFC	180uH			FLC32T-181J	L1690230		1-	
Q 3601	IC				TC23SC030AF-501	G1090970		1-	A
Q 3602	TRANSISTOR				2SC2812L6-TA	G3328127F		1-	B
Q 3602	TRANSISTOR				2SC2812NL6-TB	G3328128F		8-	B
Q 3603	TRANSISTOR				2SC2812L6-TA	G3328127F		1-	B
Q 3603	TRANSISTOR				2SC2812NL6-TB	G3328128F		8-	B
R 3602	CHIP RES.	10k	1/10W	5%	RMC1/10T 103J	J24205103		1-	
R 3603	CHIP RES.	22k	1/10W	5%	RMC1/10T 223J	J24205223		1-	
R 3604	CHIP RES.	22k	1/10W	5%	RMC1/10T 223J	J24205223		1-	
R 3605	CHIP RES.	100	1/10W	5%	RMC1/10T 101J	J24205101		1-	
R 3606	CHIP RES.	470	1/10W	5%	RMC1/10T 471J	J24205471		1-	
R 3607	CHIP RES.	100k	1/10W	5%	RMC1/10T 104J	J24205104		1-	
R 3608	CHIP RES.	1k	1/10W	5%	RMC1/10T 102J	J24205102		1-	
R 3609	CHIP RES.	0	1/10W	5%	RMC1/10T 000J	J24205000		1-	
RB3601	BLOCK RES.				RRP16B-10Z-10K/20K	J40900181		1-	
	SHIELD CASE					R0131630		1-	

I-DET Unit

Parts Layout

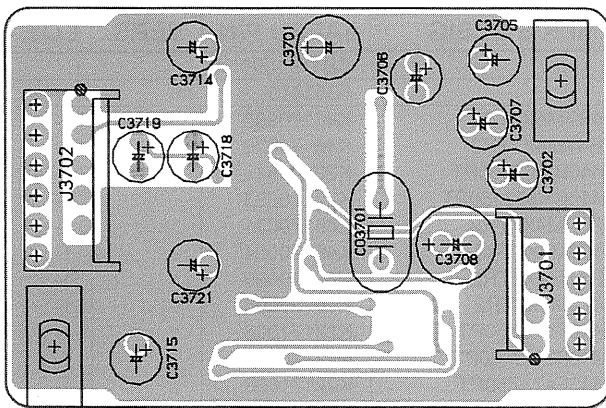

Side A

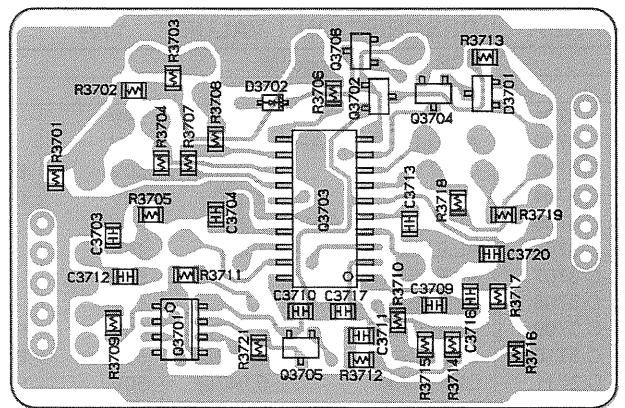

Side B

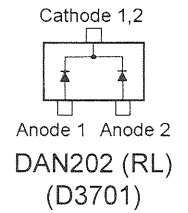
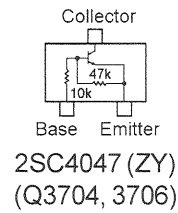
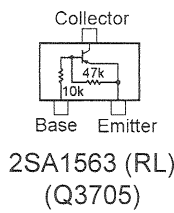
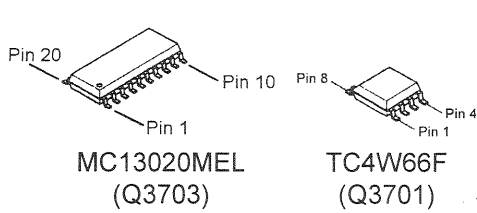

Parts Diagram

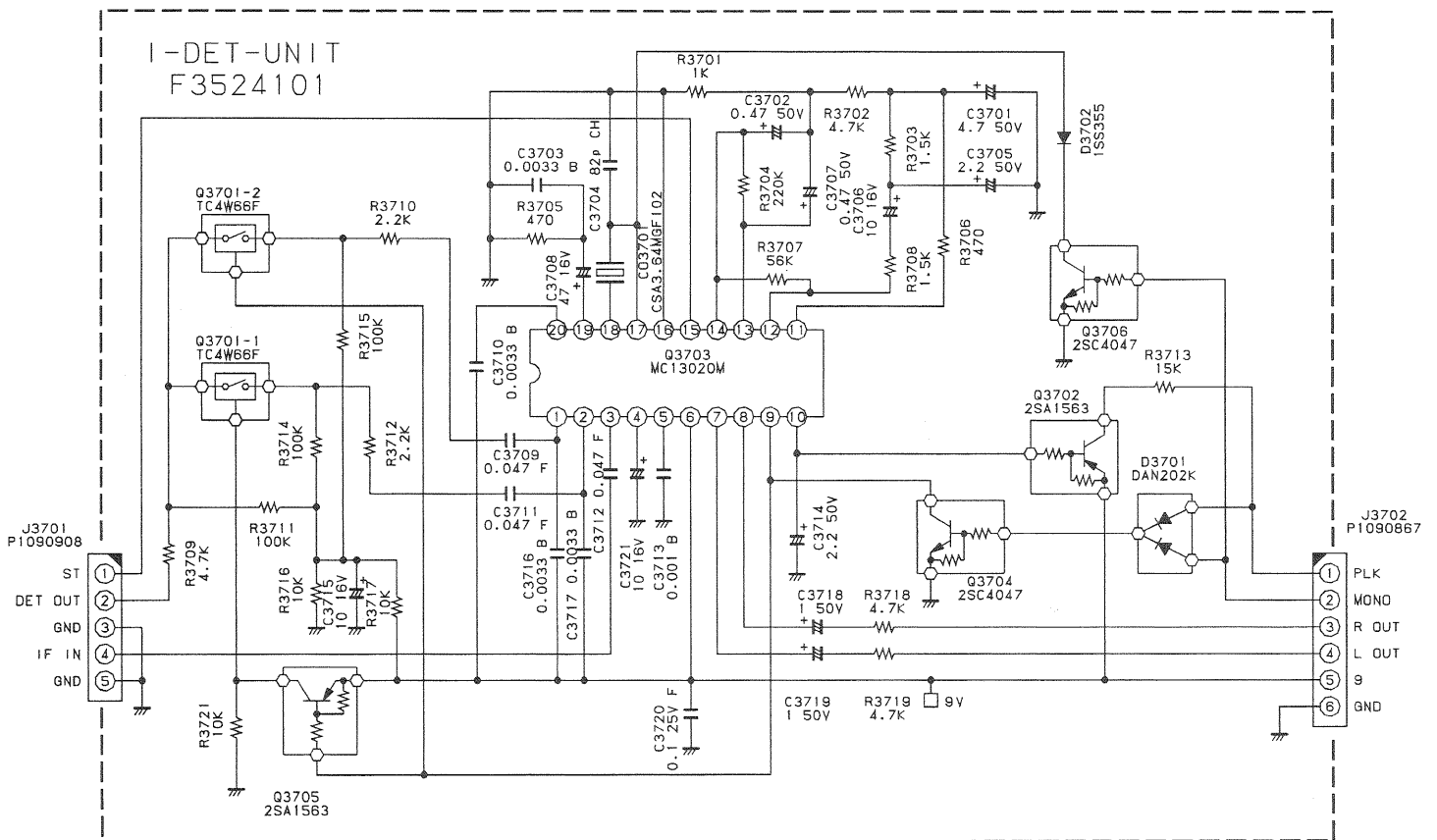

I-DET Unit

Parts List

REF.	DESCRIPTION	VALUE	V/W	TOL.	MFR'S DESIG	YAESU P/N	VERS.	LOT.	LAY ADR
PCB with Components						CB1191001			
Printed Circuit Board						F3524101		1	
C 3701	AL.ELECTRO.CAP.	4.7uF	50V		50V4R7M5X7TR2	K46170033		1-	
C 3702	AL.ELECTRO.CAP.	0.47uF	50V		50VR47M4X7TR2	K46170029		1-	
C 3703	CHIP CAP.	0.0033uF	50V	B	GRM40B332M50PT	K22170811		1-	
C 3704	CHIP CAP.	82pF	50V	CH	GRM40CH820J50PT	K22170233		1-	
C 3705	AL.ELECTRO.CAP.	2.2uF	50V		50V2R2M4X7TR2	K46170031		1-	
C 3706	AL.ELECTRO.CAP.	10uF	16V		16V100M4X7TR2	K46120004		1-	
C 3707	AL.ELECTRO.CAP.	0.47uF	50V		50VR47M4X7TR2	K46170029		1-	
C 3708	AL.ELECTRO.CAP.	47uF	16V		16V470M6X7TR2	K46120006		1-	
C 3709	CHIP CAP.	0.047uF	50V	F	GRM40F473Z50PT	K22171008		1-	
C 3710	CHIP CAP.	0.0033uF	50V	B	GRM40B332M50PT	K22170811		1-	
C 3711	CHIP CAP.	0.047uF	50V	F	GRM40F473Z50PT	K22171008		1-	
C 3712	CHIP CAP.	0.047uF	50V	F	GRM40F473Z50PT	K22171008		1-	
C 3713	CHIP CAP.	0.001uF	50V	B	GRM40B102M50PT	K22170805		1-	
C 3714	AL.ELECTRO.CAP.	2.2uF	50V		50V2R2M4X7TR2	K46170031		1-	
C 3715	AL.ELECTRO.CAP.	10uF	16V		16V100M4X7TR2	K46120004		1-	
C 3716	CHIP CAP.	0.0033uF	50V	B	GRM40B332M50PT	K22170811		1-	
C 3717	CHIP CAP.	0.0033uF	50V	B	GRM40B332M50PT	K22170811		1-	
C 3718	AL.ELECTRO.CAP.	1uF	50V		50V010M4X7TR2	K46170030		1-	
C 3719	AL.ELECTRO.CAP.	1uF	50V		50V010M4X7TR2	K46170030		1-	
C 3720	CHIP CAP.	0.1uF	25V	F	GRM40F104Z25PT	K22141005		1-	
C 3721	AL.ELECTRO.CAP.	10uF	16V		16V100M4X7TR2	K46120004		1-	
CO3701	CERAMIC OSC				CSA3.64MGF102	H7901000		1-	
D 3701	DIODE				DAN202K T146	G2070182		1-	B
D 3702	DIODE				1SS355 TE-17	G2070470		1-	B
J 3701	CONNECTOR				9133S-05D	P1090908		1-	
J 3702	CONNECTOR				9133S-06D	P1090867		1-	
Q 3701	IC				TC4W66F TE12L	G1091493		1-	B
Q 3702	TRANSISTOR				2SA1563-TB	G3115638		1-	B
Q 3703	IC				MC13020MEL	G1091822		1-	B
Q 3704	TRANSISTOR				2SC4047-TA	G3340477		1-	B
Q 3704	TRANSISTOR				UN2214-(TX)	G3070206		8-	B
Q 3705	TRANSISTOR				2SA1563-TB	G3115638		1-	B
Q 3706	TRANSISTOR				2SC4047-TA	G3340477		1-	B
Q 3706	TRANSISTOR				UN2214-(TX)	G3070206		8-	B
R 3701	CHIP RES.	1k	1/10W	5%	RMC1/10T 102J	J24205102		1-	
R 3702	CHIP RES.	4.7k	1/10W	5%	RMC1/10T 472J	J24205472		1-	
R 3703	CHIP RES.	1.5k	1/10W	5%	RMC1/10T 152J	J24205152		1-	
R 3704	CHIP RES.	220k	1/10W	5%	RMC1/10T 224J	J24205224		1-	
R 3705	CHIP RES.	470	1/10W	5%	RMC1/10T 471J	J24205471		1-	
R 3706	CHIP RES.	470	1/10W	5%	RMC1/10T 471J	J24205471		1-	
R 3707	CHIP RES.	56k	1/10W	5%	RMC1/10T 563J	J24205563		1-	
R 3708	CHIP RES.	1.5k	1/10W	5%	RMC1/10T 152J	J24205152		1-	
R 3709	CHIP RES.	4.7k	1/10W	5%	RMC1/10T 472J	J24205472		1-	
R 3710	CHIP RES.	2.2k	1/10W	5%	RMC1/10T 222J	J24205222		1-	
R 3711	CHIP RES.	100k	1/10W	5%	RMC1/10T 104J	J24205104		1-	
R 3712	CHIP RES.	2.2k	1/10W	5%	RMC1/10T 222J	J24205222		1-	
R 3713	CHIP RES.	15k	1/10W	5%	RMC1/10T 153J	J24205153		1-	
R 3714	CHIP RES.	100k	1/10W	5%	RMC1/10T 104J	J24205104		1-	
R 3715	CHIP RES.	100k	1/10W	5%	RMC1/10T 104J	J24205104		1-	
R 3716	CHIP RES.	10k	1/10W	5%	RMC1/10T 103J	J24205103		1-	
R 3717	CHIP RES.	10k	1/10W	5%	RMC1/10T 103J	J24205103		1-	
R 3718	CHIP RES.	4.7k	1/10W	5%	RMC1/10T 472J	J24205472		1-	
R 3719	CHIP RES.	4.7k	1/10W	5%	RMC1/10T 472J	J24205472		1-	
R 3721	CHIP RES.	10k	1/10W	5%	RMC1/10T 103J	J24205103		1-	

LOCAL Unit Circuit Diagram

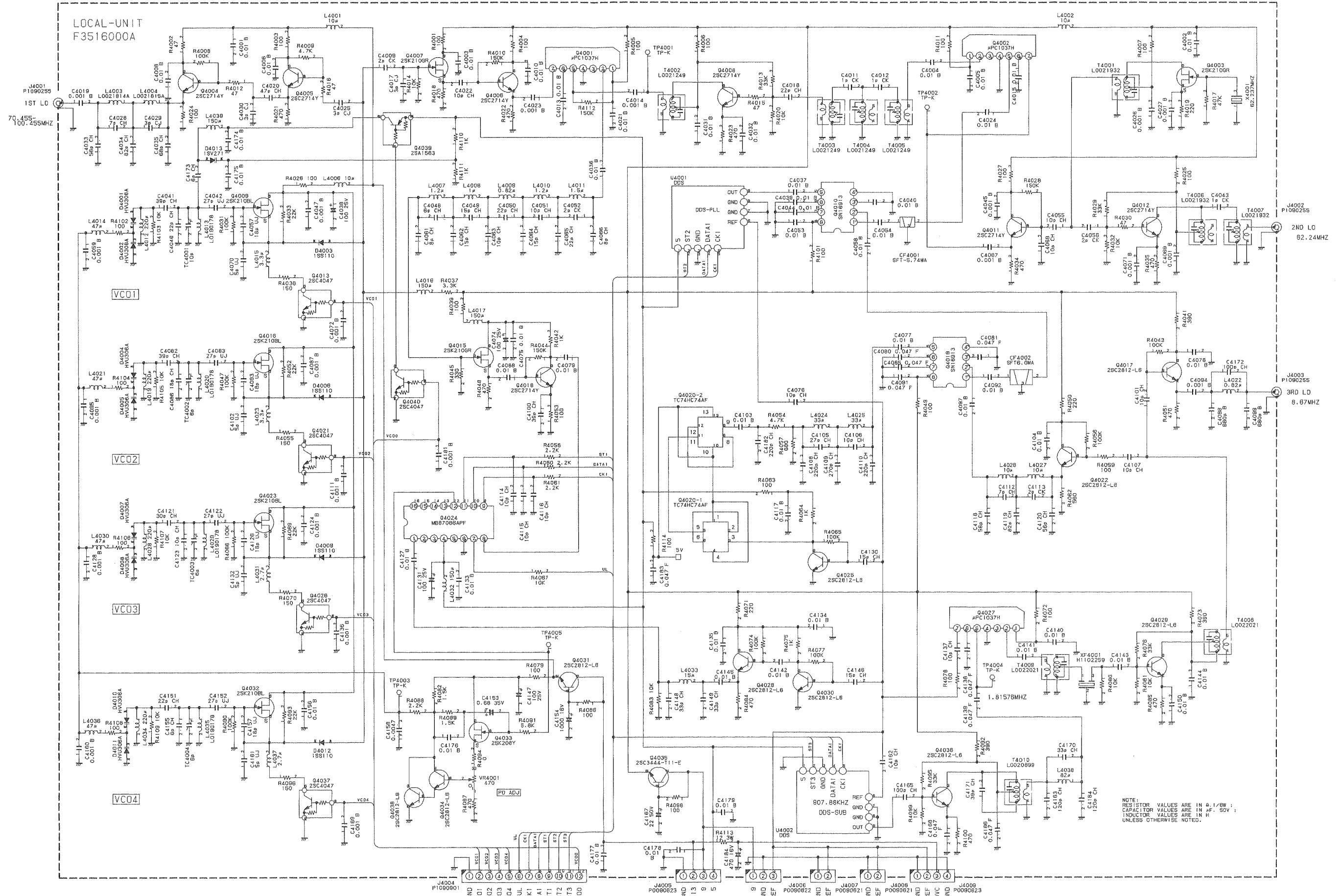

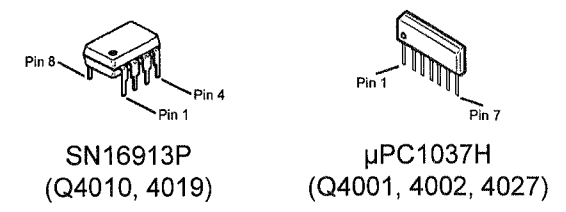
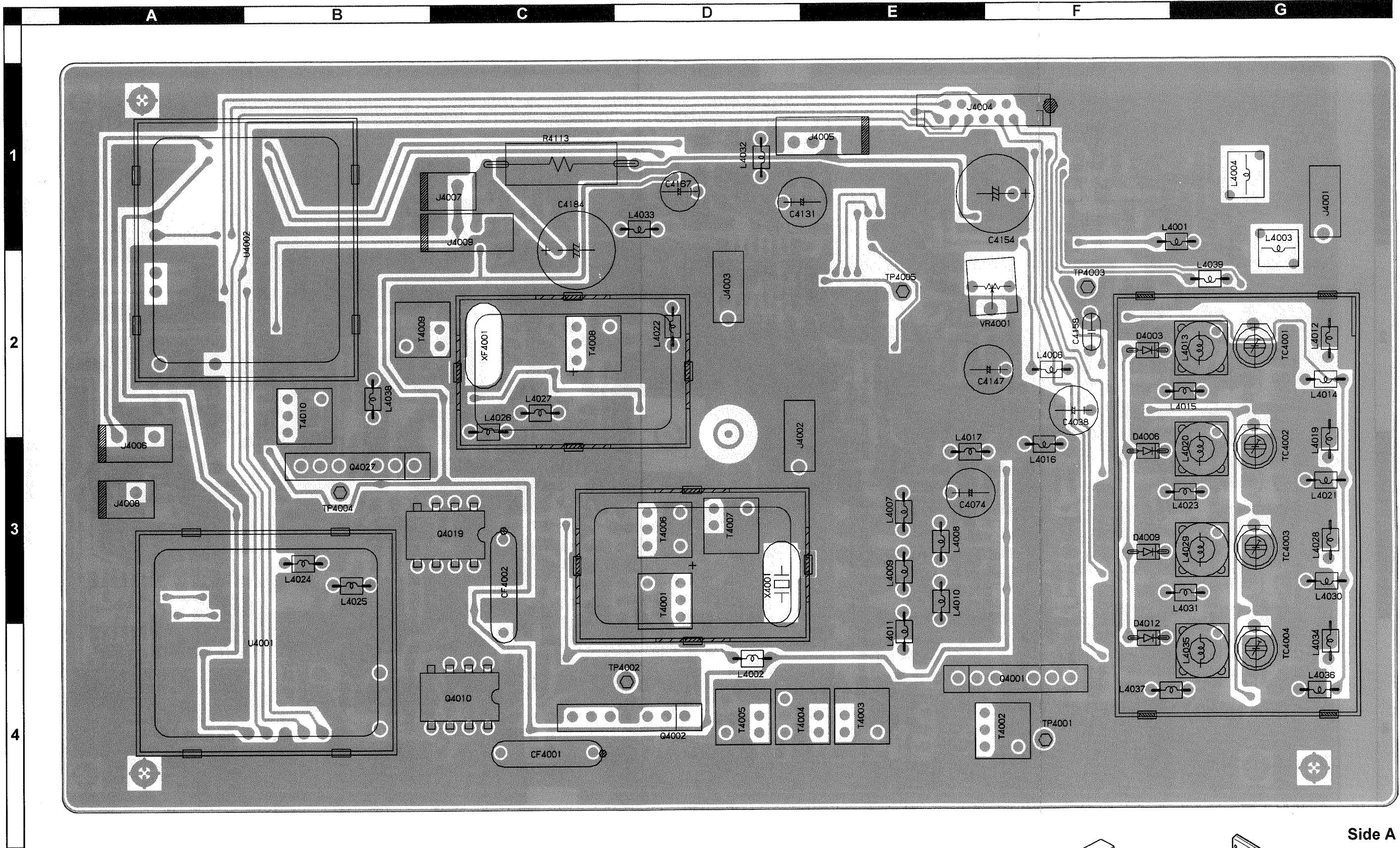

Side A

LOCAL Unit

Parts Layout

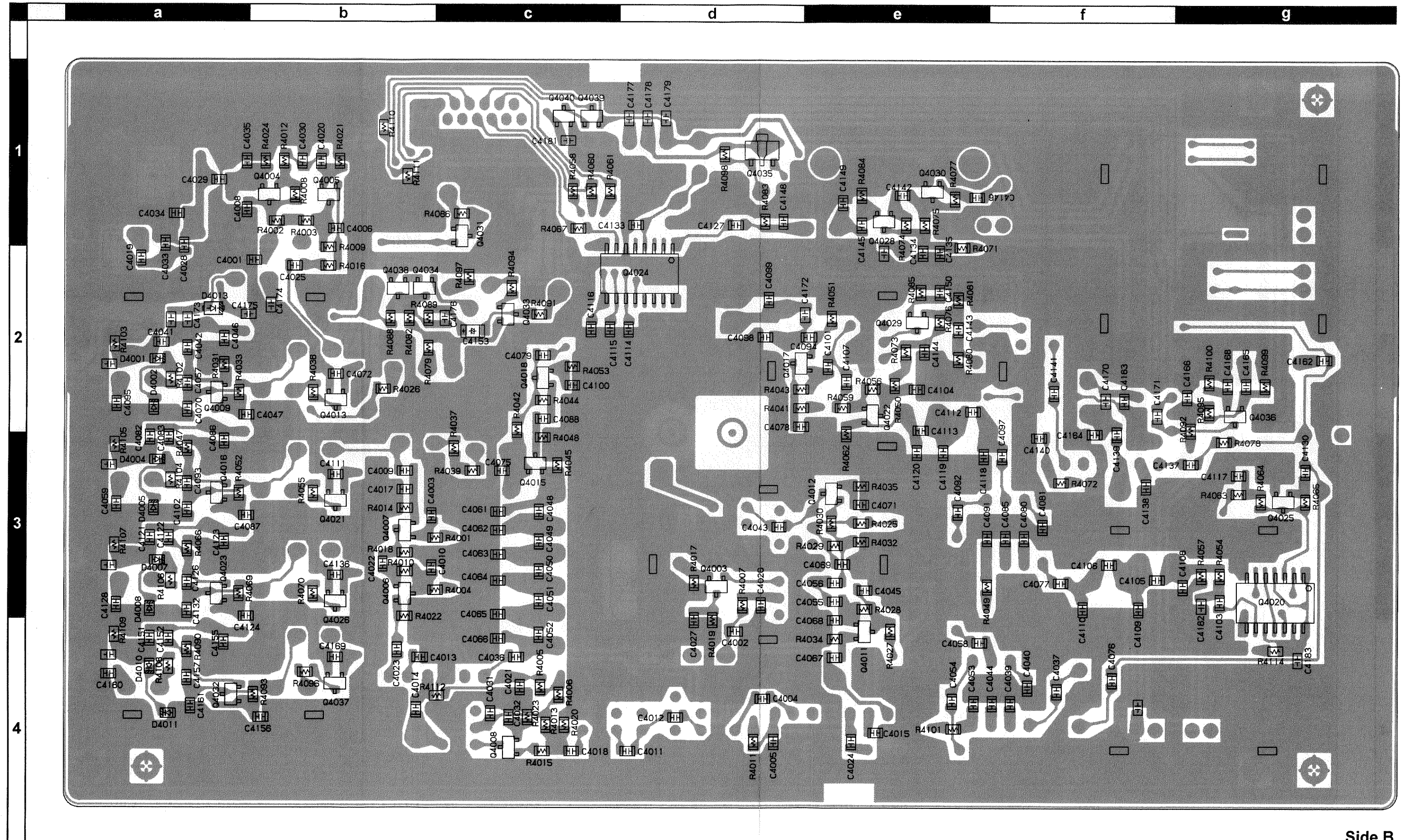

Side B

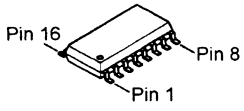

MB87086APF
(Q4024)

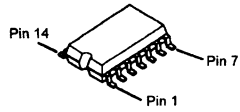

TC74HC74AF
(Q4020)

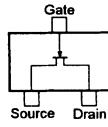

2SK208Y (JY)
(Q4033)

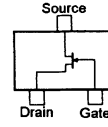

2SK210BL (YB)
(Q4016, 4023, 4032)
2SK210GR (YG)
(Q4003, 4007, 4015)

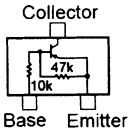

2SA1563 (RL)
(Q4039)

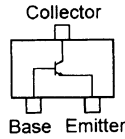

2SC2714Y (QY)
(Q4004, 4005, 4006,
4008, 4011, 4012, 4018)

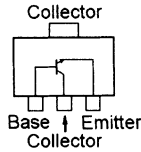

2SC3444 (DE)
(Q4035)

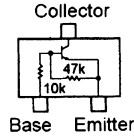

2SC4047 (ZY)
(Q4021, 4026,
4037, 4040)

2SC2812 (L6)
(Q4017, 4022, 4025,
4028, 4029, 4030, 4031,
4034, 4036, 4038)

LOCAL Unit

Parts List

REF.	DESCRIPTION	VALUE	V/W	TOL.	MFR'S DESIG	YAESU P/N	VERS.	LOT.	LAYADR
PCB with Components						CP6687001			
Printed Circuit Board						F3516000A		1	
C 4001	CHIPCAP.	0.01uF	50V	B	GRM40B103M50PT	K22170817		1-	
C 4002	CHIPCAP.	0.01uF	50V	B	GRM40B103M50PT	K22170817		1-	
C 4003	CHIPCAP.	0.01uF	50V	B	GRM40B103M50PT	K22170817		1-	
C 4004	CHIPCAP.	0.01uF	50V	B	GRM40B103M50PT	K22170817		1-	
C 4005	CHIPCAP.	0.01uF	50V	B	GRM40B103M50PT	K22170817		1-	
C 4006	CHIPCAP.	0.01uF	50V	B	GRM40B103M50PT	K22170817		1-	
C 4008	CHIPCAP.	0.01uF	50V	B	GRM40B103M50PT	K22170817		1-	
C 4009	CHIPCAP.	2pF	50V	CK	GRM40CK020C50PT	K22170203		1-	
C 4010	CHIPCAP.	0.01uF	50V	B	GRM40B103M50PT	K22170817		1-	
C 4011	CHIPCAP.	1pF	50V	CK	GRM40CK010C50PT	K22170202		1-	
C 4012	CHIPCAP.	1pF	50V	CK	GRM40CK010C50PT	K22170202		1-	
C 4013	CHIPCAP.	0.01uF	50V	B	GRM40B103M50PT	K22170817		1-	
C 4014	CHIPCAP.	0.001uF	50V	B	GRM40B102M50PT	K22170805		1-	
C 4015	CHIPCAP.	0.01uF	50V	B	GRM40B103M50PT	K22170817		1-	
C 4017	CHIPCAP.	3pF	50V	CJ	GRM40CJ030C50PT	K22170204		1-	
C 4018	CHIPCAP.	22pF	50V	CH	GRM40CH220J50PT	K22170219		1-	
C 4019	CHIPCAP.	0.001uF	50V	B	GRM40B102M50PT	K22170805		1-	
C 4020	CHIPCAP.	47pF	50V	CH	GRM40CH470J50PT	K22170227		1-	
C 4021	CHIPCAP.	0.01uF	50V	B	GRM40B103M50PT	K22170817		1-	
C 4022	CHIPCAP.	10pF	50V	CH	GRM40CH100D50PT	K22170211		1-	
C 4023	CHIPCAP.	0.001uF	50V	B	GRM40B102M50PT	K22170805		1-	
C 4024	CHIPCAP.	0.01uF	50V	B	GRM40B103M50PT	K22170817		1-	
C 4025	CHIPCAP.	3pF	50V	CJ	GRM40CJ030C50PT	K22170204		1-	
C 4026	CHIPCAP.	0.001uF	50V	B	GRM40B102M50PT	K22170805		1-	
C 4027	CHIPCAP.	0.001uF	50V	B	GRM40B102M50PT	K22170805		1-	
C 4028	CHIPCAP.	7pF	50V	CH	GRM40CH070D50PT	K22170208		1-	
C 4029	CHIPCAP.	3pF	50V	CJ	GRM40CJ030C50PT	K22170204		1-	
C 4030	CHIPCAP.	3pF	50V	CJ	GRM40CJ030C50PT	K22170204		1-	
C 4031	CHIPCAP.	0.01uF	50V	B	GRM40B103M50PT	K22170817		1-	
C 4032	CHIPCAP.	0.01uF	50V	B	GRM40B103M50PT	K22170817		1-	
C 4033	CHIPCAP.	56pF	50V	CH	GRM40CH560J50PT	K22170229		1-	
C 4034	CHIPCAP.	82pF	50V	CH	GRM40CH820J50PT	K22170233		1-	
C 4035	CHIPCAP.	68pF	50V	CH	GRM40CH680J50PT	K22170231		1-	
C 4036	CHIPCAP.	0.01uF	50V	B	GRM40B103M50PT	K22170817		1-	
C 4037	CHIPCAP.	0.01uF	50V	B	GRM40B103M50PT	K22170817		1-	
C 4038	AL.ELECTRO.CAP.	100uF	25V		25V101M6X11TR5	K46140005		1-	
C 4039	CHIPCAP.	0.01uF	50V	B	GRM40B103M50PT	K22170817		1-	
C 4040	CHIPCAP.	0.01uF	50V	B	GRM40B103M50PT	K22170817		1-	
C 4041	CHIPCAP.	39pF	50V	CH	GRM40CH390J50PT	K22170225		1-	
C 4042	CHIPCAP.	27pF	50V	UJ	GRM40UJ270J50PT	K22170321		1-	
C 4043	CHIPCAP.	1pF	50V	CK	GRM40CK010C50PT	K22170202		1-	
C 4044	CHIPCAP.	0.01uF	50V	B	GRM40B103M50PT	K22170817		1-	
C 4045	CHIPCAP.	0.001uF	50V	B	GRM40B102M50PT	K22170805		1-	
C 4046	CHIPCAP.	22pF	50V	CH	GRM40CH220J50PT	K22170219		1-	
C 4047	CHIPCAP.	0.001uF	50V	B	GRM40B102M50PT	K22170805		1-	
C 4048	CHIPCAP.	6pF	50V	CH	GRM40CH060D50PT	K22170207		1-	
C 4049	CHIPCAP.	15pF	50V	CH	GRM40CH150J50PT	K22170215		1-	
C 4050	CHIPCAP.	22pF	50V	CH	GRM40CH220J50PT	K22170219		1-	
C 4051	CHIPCAP.	10pF	50V	CH	GRM40CH100D50PT	K22170211		1-	
C 4052	CHIPCAP.	2pF	50V	CK	GRM40CK020C50PT	K22170203		1-	
C 4053	CHIPCAP.	0.01uF	50V	B	GRM40B103M50PT	K22170817		1-	
C 4054	CHIPCAP.	0.01uF	50V	B	GRM40B103M50PT	K22170817		1-	
C 4055	CHIPCAP.	10pF	50V	CH	GRM40CH100D50PT	K22170211		1-	
C 4056	CHIPCAP.	2pF	50V	CK	GRM40CK020C50PT	K22170203		1-	
C 4057	CHIPCAP.	18pF	50V	UJ	GRM40UJ180J50PT	K22170317		1-	
C 4058	CHIPCAP.	0.01uF	50V	B	GRM40B103M50PT	K22170817		1-	
C 4059	CHIPCAP.	0.001uF	50V	B	GRM40B102M50PT	K22170805		1-	
C 4061	CHIPCAP.	8pF	50V	CH	GRM40CH080D50PT	K22170209		1-	
C 4062	CHIPCAP.	15pF	50V	CH	GRM40CH150J50PT	K22170215		1-	
C 4063	CHIPCAP.	10pF	50V	CH	GRM40CH100D50PT	K22170211		1-	
C 4064	CHIPCAP.	15pF	50V	CH	GRM40CH150J50PT	K22170215		1-	
C 4065	CHIPCAP.	22pF	50V	CH	GRM40CH220J50PT	K22170219		1-	
C 4066	CHIPCAP.	8pF	50V	CH	GRM40CH080D50PT	K22170209		1-	
C 4067	CHIPCAP.	0.001uF	50V	B	GRM40B102M50PT	K22170805		1-	
C 4068	CHIPCAP.	10pF	50V	CH	GRM40CH100D50PT	K22170211		1-	
C 4069	CHIPCAP.	0.001uF	50V	B	GRM40B102M50PT	K22170805		1-	

LOCAL Unit

Parts List

REF.	DESCRIPTION	VALUE	V/W	TOL.	MFR'S DESIG	YAESU P/N	VERS.	LOT.	LAY ADR
C 4070	CHIPCAP.	5pF	50V	WJ	GRM40UJ050C50PT	K22170306		1-	
C 4071	CHIPCAP.	0.001uF	50V	B	GRM40B102M50PT	K22170805		1-	
C 4072	CHIPCAP.	0.001uF	50V	B	GRM40B102M50PT	K22170805		1-	
C 4074	AL.ELECTRO.CAP.	100uF	25V		25V101M6X11TR5	K46140005		1-	
C 4075	CHIPCAP.	0.01uF	50V	B	GRM40B103M50PT	K22170817		1-	
C 4076	CHIPCAP.	10pF	50V	CH	GRM40CH100D50PT	K22170211		1-	
C 4077	CHIPCAP.	0.01uF	50V	B	GRM40B103M50PT	K22170817		1-	
C 4078	CHIPCAP.	0.01uF	50V	B	GRM40B103M50PT	K22170817		1-	
C 4079	CHIPCAP.	0.01uF	50V	B	GRM40B103M50PT	K22170817		1-	
C 4080	CHIPCAP.	0.047uF	50V	F	GRM40F473Z50PT	K22171008		1-	
C 4081	CHIPCAP.	0.047uF	50V	F	GRM40F473Z50PT	K22171008		1-	
C 4082	CHIPCAP.	39pF	50V	CH	GRM40CH390J50PT	K22170225		1-	
C 4083	CHIPCAP.	27pF	50V	WJ	GRM40UJ270J50PT	K22170321		1-	
C 4085	CHIPCAP.	0.047uF	50V	F	GRM40F473Z50PT	K22171008		1-	
C 4086	CHIPCAP.	18pF	50V	CH	GRM40CH180J50PT	K22170217		1-	
C 4087	CHIPCAP.	0.001uF	50V	B	GRM40B102M50PT	K22170805		1-	
C 4088	CHIPCAP.	0.01uF	50V	B	GRM40B103M50PT	K22170817		1-	
C 4091	CHIPCAP.	0.047uF	50V	F	GRM40F473Z50PT	K22171008		1-	
C 4092	CHIPCAP.	0.01uF	50V	B	GRM40B103M50PT	K22170817		1-	
C 4093	CHIPCAP.	18pF	50V	WJ	GRM40UJ180J50PT	K22170317		1-	
C 4094	CHIPCAP.	0.001uF	50V	B	GRM40B102M50PT	K22170805		1-	
C 4095	CHIPCAP.	0.001uF	50V	B	GRM40B102M50PT	K22170805		1-	
C 4097	CHIPCAP.	0.01uF	50V	B	GRM40B103M50PT	K22170817		1-	
C 4098	CHIPCAP.	680pF	50V	B	GRM40B681M50PT	K22170803		1-	
C 4099	CHIPCAP.	680pF	50V	B	GRM40B681M50PT	K22170803		1-	
C 4100	CHIPCAP.	39pF	50V	CH	GRM40CH390J50PT	K22170225		1-	
C 4101	CHIPCAP.	10pF	50V	CH	GRM40CH100D50PT	K22170211		1-	
C 4102	CHIPCAP.	5pF	50V	WJ	GRM40UJ050C50PT	K22170306		1-	
C 4103	CHIPCAP.	0.01uF	50V	B	GRM40B103M50PT	K22170817		1-	
C 4104	CHIPCAP.	0.01uF	50V	B	GRM40B103M50PT	K22170817		1-	
C 4105	CHIPCAP.	27pF	50V	CH	GRM40CH270J50PT	K22170221		1-	
C 4106	CHIPCAP.	10pF	50V	CH	GRM40CH100D50PT	K22170211		1-	
C 4107	CHIPCAP.	10pF	50V	CH	GRM40CH100D50PT	K22170211		1-	
C 4108	CHIPCAP.	220pF	50V	CH	GRM40CH221J50PT	K22170243		1-	
C 4109	CHIPCAP.	270pF	50V	CH	GRM40CH271J50PT	K22170245		1-	
C 4110	CHIPCAP.	220pF	50V	CH	GRM40CH221J50PT	K22170243		1-	
C 4111	CHIPCAP.	0.001uF	50V	B	GRM40B102M50PT	K22170805		1-	
C 4112	CHIPCAP.	7pF	50V	CH	GRM40CH070D50PT	K22170208		1-	
C 4113	CHIPCAP.	2pF	50V	CK	GRM40CK020C50PT	K22170203		1-	
C 4114	CHIPCAP.	10pF	50V	CH	GRM40CH100D50PT	K22170211		1-	
C 4115	CHIPCAP.	10pF	50V	CH	GRM40CH100D50PT	K22170211		1-	
C 4116	CHIPCAP.	10pF	50V	CH	GRM40CH100D50PT	K22170211		1-	
C 4117	CHIPCAP.	0.01uF	50V	B	GRM40B103M50PT	K22170817		1-	
C 4118	CHIPCAP.	56pF	50V	CH	GRM40CH560J50PT	K22170229		1-	
C 4119	CHIPCAP.	82pF	50V	CH	GRM40CH820J50PT	K22170233		1-	
C 4120	CHIPCAP.	56pF	50V	CH	GRM40CH560J50PT	K22170229		1-	
C 4121	CHIPCAP.	30pF	50V	CH	GRM40CH300J50PT	K22170222		1-	
C 4122	CHIPCAP.	27pF	50V	WJ	GRM40UJ270J50PT	K22170321		1-	
C 4123	CHIPCAP.	10pF	50V	CH	GRM40CH100D50PT	K22170211		1-	
C 4124	CHIPCAP.	0.001uF	50V	B	GRM40B102M50PT	K22170805		1-	
C 4126	CHIPCAP.	18pF	50V	WJ	GRM40UJ180J50PT	K22170317		1-	
C 4127	CHIPCAP.	0.01uF	50V	B	GRM40B103M50PT	K22170817		1-	
C 4128	CHIPCAP.	0.001uF	50V	B	GRM40B102M50PT	K22170805		1-	
C 4130	CHIPCAP.	15pF	50V	CH	GRM40CH150J50PT	K22170215		1-	
C 4131	AL.ELECTRO.CAP.	100uF	25V		25V101M6X11TR5	K46140005		1-	
C 4132	CHIPCAP.	5pF	50V	WJ	GRM40UJ050C50PT	K22170306		1-	
C 4133	CHIPCAP.	0.01uF	50V	B	GRM40B103M50PT	K22170817		1-	
C 4134	CHIPCAP.	0.01uF	50V	B	GRM40B103M50PT	K22170817		1-	
C 4135	CHIPCAP.	0.01uF	50V	B	GRM40B103M50PT	K22170817		1-	
C 4136	CHIPCAP.	0.001uF	50V	B	GRM40B102M50PT	K22170805		1-	
C 4137	CHIPCAP.	10pF	50V	CH	GRM40CH100D50PT	K22170211		1-	
C 4138	CHIPCAP.	0.047uF	50V	F	GRM40F473Z50PT	K22171008		1-	
C 4139	CHIPCAP.	0.047uF	50V	F	GRM40F473Z50PT	K22171008		1-	
C 4140	CHIPCAP.	0.01uF	50V	B	GRM40B103M50PT	K22170817		1-	
C 4141	CHIPCAP.	0.01uF	50V	B	GRM40B103M50PT	K22170817		1-	
C 4142	CHIPCAP.	0.01uF	50V	B	GRM40B103M50PT	K22170817		1-	
C 4143	CHIPCAP.	0.01uF	50V	B	GRM40B103M50PT	K22170817		1-	
C 4144	CHIPCAP.	0.01uF	50V	B	GRM40B103M50PT	K22170817		1-	

LOCAL Unit

Parts List

REF.	DESCRIPTION	VALUE	V/W	TOL.	MFR'S DESIG	YAESU P/N	VERS.	LOT.	LAY ADR
C 4145	CHIPCAP.	0.01uF	50V	B	GRM40B103M50PT	K22170817		1-	
C 4146	CHIPCAP.	15pF	50V	CH	GRM40CH150J50PT	K22170215		1-	
C 4147	AL.ELECTRO.CAP.	100uF	25V		25V101M6X11TR5	K46140005		1-	
C 4148	CHIPCAP.	33pF	50V	CH	GRM40CH330J50PT	K22170223		1-	
C 4149	CHIPCAP.	33pF	50V	CH	GRM40CH330J50PT	K22170223		1-	
C 4150	CHIPCAP.	0.01uF	50V	B	GRM40B103M50PT	K22170817		1-	
C 4151	CHIPCAP.	22pF	50V	CH	GRM40CH220J50PT	K22170219		1-	
C 4152	CHIPCAP.	27pF	50V	W	GRM40UJ270J50PT	K22170321		1-	
C 4153	CHIPTA.CAP.	0.68uF	35V		TEMSVA1V684M-8R	K78160030		1-	
C 4154	AL.ELECTRO.CAP.	1000uF	16V		RE3-16V102MS 1000UF	K40129067		1-	
C 4155	CHIPCAP.	6pF	50V	CH	GRM40CH060D50PT	K22170207		1-	
C 4156	CHIPCAP.	0.01uF	50V	B	GRM40B103M50PT	K22170817		1-	
C 4157	CHIPCAP.	18pF	50V	W	GRM40UJ180J50PT	K22170317		1-	
C 4158	FILM CAP.	0.0047uF	50V		AMZV0050K47200000200	K56170032		1-	
C 4160	CHIPCAP.	0.001uF	50V	B	GRM40B102M50PT	K22170805		1-	
C 4161	CHIPCAP.	5pF	50V	W	GRM40UJ050C50PT	K22170306		1-	
C 4162	CHIPCAP.	10pF	50V	CH	GRM40CH100D50PT	K22170211		1-	
C 4163	CHIPCAP.	120pF	50V	CH	GRM40CH121J50PT	K22170237		1-	
C 4164	CHIPCAP.	120pF	50V	CH	GRM40CH121J50PT	K22170237		1-	
C 4165	CHIPCAP.	100pF	50V	CH	GRM40CH101J50PT	K22170235		1-	
C 4166	CHIPCAP.	0.047uF	50V	F	GRM40F473Z50PT	K22171008		1-	
C 4167	AL.ELECTRO.CAP.	22uF	50V		50V220M5X11TR5	K46170022		1-	
C 4168	CHIPCAP.	0.047uF	50V	F	GRM40F473Z50PT	K22171008		1-	
C 4169	CHIPCAP.	0.001uF	50V	B	GRM40B102M50PT	K22170805		1-	
C 4170	CHIPCAP.	33pF	50V	CH	GRM40CH330J50PT	K22170223		1-	
C 4171	CHIPCAP.	39pF	50V	CH	GRM40CH390J50PT	K22170225		1-	
C 4172	CHIPCAP.	100pF	50V	CH	GRM40CH101J50PT	K22170235		1-	
C 4173	CHIPCAP.	6pF	50V	CH	GRM40CH060D50PT	K22170207		1-	
C 4174	CHIPCAP.	0.01uF	50V	B	GRM40B103M50PT	K22170817		1-	
C 4175	CHIPCAP.	0.01uF	50V	B	GRM40B103M50PT	K22170817		1-	
C 4176	CHIPCAP.	0.01uF	50V	B	GRM40B103M50PT	K22170817		1-	
C 4177	CHIPCAP.	0.01uF	50V	B	GRM40B103M50PT	K22170817		1-	
C 4178	CHIPCAP.	0.01uF	50V	B	GRM40B103M50PT	K22170817		1-	
C 4179	CHIPCAP.	0.01uF	50V	B	GRM40B103M50PT	K22170817		1-	
C 4181	CHIPCAP.	0.001uF	50V	B	GRM40B102M50PT	K22170805		1-	
C 4182	CHIPCAP.	220pF	50V	CH	GRM40CH221J50PT	K22170243		1-	
C 4183	CHIPCAP.	0.047uF	50V	F	GRM40F473Z50PT	K22171008		1-	
C 4184	AL.ELECTRO.CAP.	470uF	16V		RE2-16V471M 470UF	K40129049		1-	
CF4001	CERAMICFILTER				SFT-5.74MA	H3900390		1-	
CF4002	CERAMICFILTER				SFT6.0MA	H3900450		1-	
D 4001	DIODE				HVU306A5TRF	G2070132		1-	a2
D 4002	DIODE				HVU306A5TRF	G2070132		1-	a2
D 4003	DIODE				1SS110TJ	G2060010		1-	F2
D 4004	DIODE				HVU306A5TRF	G2070132		1-	a3
D 4005	DIODE				HVU306A5TRF	G2070132		1-	a3
D 4006	DIODE				1SS110TJ	G2060010		1-	F3
D 4007	DIODE				HVU306A5TRF	G2070132		1-	a3
D 4008	DIODE				HVU306A5TRF	G2070132		1-	a3
D 4009	DIODE				1SS110TJ	G2060010		1-	F3
D 4010	DIODE				HVU306A5TRF	G2070132		1-	a4
D 4011	DIODE				HVU306A5TRF	G2070132		1-	a4
D 4012	DIODE				1SS110TJ	G2060010		1-	F4
D 4013	DIODE				1SV271 TPH3	G2070476		1-	a2
J 4001	CONNECTOR				TMP-J01X-A2	P1090255		1-	
J 4002	CONNECTOR				TMP-J01X-A2	P1090255		1-	
J 4003	CONNECTOR				TMP-J01X-A2	P1090255		1-	
J 4004	CONNECTOR				12FMZ-BT	P1090901		1-	
J 4005	CONNECTOR				SC25-04WS	P0090623		1-	
J 4006	CONNECTOR				SC25-03WS	P0090622		1-	
J 4007	CONNECTOR				SC25-02WS	P0090621		1-	
J 4008	CONNECTOR				SC25-02WS	P0090621		1-	
J 4009	CONNECTOR				SC25-04WS	P0090623		1-	
L 4001	M.RFC	10uH			LAP02TA100K	L1790058		1-	
L 4002	M.RFC	10uH			LAP02TA100K	L1790058		1-	
L 4003	COILA1				5.5T3.0D0.6UEWR	L0021814A		1-	
L 4004	COILA1				6.5T3.0D0.6UEWR	L0021815A		1-	
L 4006	M.RFC	10uH			LAP02TA100K	L1790058		1-	
L 4007	M.RFC	1.2uH			LAP02TA1R2K	L1790047		1-	

REF.	DESCRIPTION	VALUE	V/W	TOL.	MFR'S DESIG	YAESU P/N	VERS.	LOT.	LAYADR
L 4008	M.RFC	1uH			LAP02TA1R0K	L1790046		1-	
L 4009	M.RFC	0.82uH			LAP02TAR82K	L1790045		1-	
L 4010	M.RFC	1.2uH			LAP02TA1R2K	L1790047		1-	
L 4011	M.RFC	1.5uH			LAP02TA1R5K	L1790048		1-	
L 4012	M.RFC	220uH			LAP02TA221K	L1790074		1-	
L 4013	COIL				S7-M1 R12-L722E	L0190178		1-	
L 4014	M.RFC	47uH			LAP02TA470K	L1790066		1-	
L 4015	M.RFC	3.3uH			LAP02TA3R3K	L1790052		1-	
L 4016	M.RFC	150uH			LAP02TA151K	L1790072		1-	
L 4017	M.RFC	150uH			LAP02TA151K	L1790072		1-	
L 4019	M.RFC	220uH			LAP02TA221K	L1790074		1-	
L 4020	COIL				S7-M1 R12-L722E	L0190178		1-	
L 4021	M.RFC	47uH			LAP02TA470K	L1790066		1-	
L 4022	M.RFC	0.82uH			LAP02TAR82K	L1790045		1-	
L 4023	M.RFC	3.3uH			LAP02TA3R3K	L1790052		1-	
L 4024	M.RFC	33uH			LAP02TA330K	L1790064		1-	
L 4025	M.RFC	33uH			LAP02TA330K	L1790064		1-	
L 4026	M.RFC	10uH			LAP02TA100K	L1790058		1-	
L 4027	M.RFC	10uH			LAP02TA100K	L1790058		1-	
L 4028	M.RFC	220uH			LAP02TA221K	L1790074		1-	
L 4029	COIL				S7-M1 R12-L722E	L0190178		1-	
L 4030	M.RFC	47uH			LAP02TA470K	L1790066		1-	
L 4031	M.RFC	2.7uH			LAP02TA2R7K	L1790051		1-	
L 4032	M.RFC	150uH			LAP02TA151K	L1790072		1-	
L 4033	M.RFC	15uH			LAP02TA150K	L1790060		1-	
L 4034	M.RFC	220uH			LAP02TA221K	L1790074		1-	
L 4035	COIL				S7-M1 R12-L722E	L0190178		1-	
L 4036	M.RFC	47uH			LAP02TA470K	L1790066		1-	
L 4037	M.RFC	2.7uH			LAP02TA2R7K	L1790051		1-	
L 4038	M.RFC	82uH			LAP02TA820K	L1790069		1-	
L 4039	M.RFC	150uH			LAP02TA151K	L1790072		1-	
Q 4001	IC				UPC1037H	G1090101		1-	F4
Q 4002	IC				UPC1037H	G1090101		1-	D4
Q 4003	FET				2SK210GR TE85R	G3802107G		1-	d3
Q 4004	TRANSISTOR				2SC2714YTE85R	G3327147Y		1-	b1
Q 4005	TRANSISTOR				2SC2714YTE85R	G3327147Y		1-	b1
Q 4006	TRANSISTOR				2SC2714YTE85R	G3327147Y		1-	b3
Q 4007	FET				2SK210GR TE85R	G3802107G		1-	b3
Q 4008	TRANSISTOR				2SC2714YTE85R	G3327147Y		1-	c4
Q 4009	FET				2SK210BL TE85R	G3802107B		1-	a2
Q 4010	IC				SN16913P	G1090012		1-	C4
Q 4011	TRANSISTOR				2SC2714YTE85R	G3327147Y		1-	e4
Q 4012	TRANSISTOR				2SC2714YTE85R	G3327147Y		1-	e3
Q 4013	TRANSISTOR				2SC4047-TA	G3340477		1-	b2
Q 4013	TRANSISTOR				UN2214-(TX)	G3070206		8-	b2
Q 4015	FET				2SK210GR TE85R	G3802107G		1-	c3
Q 4016	FET				2SK210BL TE85R	G3802107B		1-	a3
Q 4017	TRANSISTOR				2SC2812L6-TA	G3328127F		1-	d2
Q 4017	TRANSISTOR				2SC2812NL6-TB	G3328128F		8-	d2
Q 4018	TRANSISTOR				2SC2714YTE85R	G3327147Y		1-	c2
Q 4019	IC				SN16913P	G1090012		1-	C3
Q 4020	IC				TC74HC74AF EL	G1091446		1-	g3
Q 4021	TRANSISTOR				2SC4047-TA	G3340477		1-	b3
Q 4021	TRANSISTOR				UN2214-(TX)	G3070206		8-	b3
Q 4022	TRANSISTOR				2SC2812L6-TA	G3328127F		1-	e2
Q 4022	TRANSISTOR				2SC2812NL6-TB	G3328128F		8-	e2
Q 4023	FET				2SK210BL TE85R	G3802107B		1-	a3
Q 4024	IC				MB87086APF-G-BND-TF	G1091419		1-	d2
Q 4025	TRANSISTOR				2SC2812L6-TA	G3328127F		1-	g3
Q 4025	TRANSISTOR				2SC2812NL6-TB	G3328128F		8-	g3
Q 4026	TRANSISTOR				2SC4047-TA	G3340477		1-	b3
Q 4026	TRANSISTOR				UN2214-(TX)	G3070206		8-	b3
Q 4027	IC				UPC1037H	G1090101		1-	B3
Q 4028	TRANSISTOR				2SC2812L6-TA	G3328127F		1-	e1
Q 4028	TRANSISTOR				2SC2812NL6-TB	G3328128F		8-	e1
Q 4029	TRANSISTOR				2SC2812L6-TA	G3328127F		1-	e2
Q 4029	TRANSISTOR				2SC2812NL6-TB	G3328128F		8-	e2
Q 4030	TRANSISTOR				2SC2812L6-TA	G3328127F		1-	e1

LOCAL Unit

Parts List

REF.	DESCRIPTION	VALUE	V/W	TOL.	MFR'S DESIG	YAESU P/N	VERS.	LOT.	LAY ADR
Q 4030	TRANSISTOR				2SC2812NL6-TB	G3328128F		8-	e1
Q 4031	TRANSISTOR				2SC2812L6-TA	G3328127F		1-	c1
Q 4031	TRANSISTOR				2SC2812NL6-TB	G3328128F		8-	c1
Q 4032	FET				2SK210BL TE85R	G3802107B		1-	a3
Q 4033	FET				2SK208Y TE85R	G3802087Y		1-	c2
Q 4034	TRANSISTOR				2SC2812L6-TA	G3328127F		1-	b2
Q 4034	TRANSISTOR				2SC2812NL6-TB	G3328128F		8-	b2
Q 4035	TRANSISTOR				2SC3444-T11-1E	G3334448E		1-	d1
Q 4036	TRANSISTOR				2SC2812L6-TA	G3328127F		1-	g2
Q 4036	TRANSISTOR				2SC2812NL6-TB	G3328128F		8-	g2
Q 4037	TRANSISTOR				2SC4047-TA	G3340477		1-	b4
Q 4037	TRANSISTOR				UN2214-(TX)	G3070206		8-	b4
Q 4038	TRANSISTOR				2SC2812L6-TA	G3328127F		1-	b2
Q 4038	TRANSISTOR				2SC2812NL6-TB	G3328128F		8-	b2
Q 4039	TRANSISTOR				2SA1563-TB	G3115638		1-	c1
Q 4040	TRANSISTOR				2SC4047-TA	G3340477		1-	c1
Q 4040	TRANSISTOR				UN2214-(TX)	G3070206		8-	c1
R 4001	CHIPRES.	100	1/10W	5%	RMC1/10T 101J	J24205101		1-	
R 4002	CHIPRES.	47	1/10W	5%	RMC1/10T 470J	J24205470		1-	
R 4003	CHIPRES.	100	1/10W	5%	RMC1/10T 101J	J24205101		1-	
R 4004	CHIPRES.	100	1/10W	5%	RMC1/10T 101J	J24205101		1-	
R 4005	CHIPRES.	100	1/10W	5%	RMC1/10T 101J	J24205101		1-	
R 4006	CHIPRES.	100	1/10W	5%	RMC1/10T 101J	J24205101		1-	
R 4007	CHIPRES.	100	1/10W	5%	RMC1/10T 101J	J24205101		1-	
R 4008	CHIPRES.	100k	1/10W	5%	RMC1/10T 104J	J24205104		1-	
R 4009	CHIPRES.	4.7k	1/10W	5%	RMC1/10T 472J	J24205472		1-	
R 4010	CHIPRES.	150k	1/10W	5%	RMC1/10T 154J	J24205154		1-	
R 4011	CHIPRES.	100	1/10W	5%	RMC1/10T 101J	J24205101		1-	
R 4012	CHIPRES.	47	1/10W	5%	RMC1/10T 470J	J24205470		1-	
R 4013	CHIPRES.	33k	1/10W	5%	RMC1/10T 333J	J24205333		1-	
R 4014	CHIPRES.	10k	1/10W	5%	RMC1/10T 103J	J24205103		1-	
R 4015	CHIPRES.	47	1/10W	5%	RMC1/10T 470J	J24205470		1-	
R 4016	CHIPRES.	47	1/10W	5%	RMC1/10T 470J	J24205470		1-	
R 4017	CHIPRES.	47k	1/10W	5%	RMC1/10T 473J	J24205473		1-	
R 4018	CHIPRES.	470	1/10W	5%	RMC1/10T 471J	J24205471		1-	
R 4019	CHIPRES.	220	1/10W	5%	RMC1/10T 221J	J24205221		1-	
R 4020	CHIPRES.	10k	1/10W	5%	RMC1/10T 103J	J24205103		1-	
R 4021	CHIPRES.	470	1/10W	5%	RMC1/10T 471J	J24205471		1-	
R 4022	CHIPRES.	470	1/10W	5%	RMC1/10T 471J	J24205471		1-	
R 4023	CHIPRES.	470	1/10W	5%	RMC1/10T 471J	J24205471		1-	
R 4024	CHIPRES.	100	1/10W	5%	RMC1/10T 101J	J24205101		1-	
R 4025	CHIPRES.	100	1/10W	5%	RMC1/10T 101J	J24205101		1-	
R 4026	CHIPRES.	100	1/10W	5%	RMC1/10T 101J	J24205101		1-	
R 4027	CHIPRES.	100	1/10W	5%	RMC1/10T 101J	J24205101		1-	
R 4028	CHIPRES.	150k	1/10W	5%	RMC1/10T 154J	J24205154		1-	
R 4029	CHIPRES.	33k	1/10W	5%	RMC1/10T 333J	J24205333		1-	
R 4030	CHIPRES.	47	1/10W	5%	RMC1/10T 470J	J24205470		1-	
R 4031	CHIPRES.	100k	1/10W	5%	RMC1/10T 104J	J24205104		1-	
R 4032	CHIPRES.	10k	1/10W	5%	RMC1/10T 103J	J24205103		1-	
R 4033	CHIPRES.	22k	1/10W	5%	RMC1/10T 223J	J24205223		1-	
R 4034	CHIPRES.	470	1/10W	5%	RMC1/10T 471J	J24205471		1-	
R 4035	CHIPRES.	470	1/10W	5%	RMC1/10T 471J	J24205471		1-	
R 4036	CHIPRES.	150	1/10W	5%	RMC1/10T 151J	J24205151		1-	
R 4037	CHIPRES.	3.3k	1/10W	5%	RMC1/10T 332J	J24205332		1-	
R 4039	CHIPRES.	100	1/10W	5%	RMC1/10T 101J	J24205101		1-	
R 4041	CHIPRES.	390	1/10W	5%	RMC1/10T 391J	J24205391		1-	
R 4042	CHIPRES.	1k	1/10W	5%	RMC1/10T 102J	J24205102		1-	
R 4043	CHIPRES.	100k	1/10W	5%	RMC1/10T 104J	J24205104		1-	
R 4044	CHIPRES.	150k	1/10W	5%	RMC1/10T 154J	J24205154		1-	
R 4045	CHIPRES.	330	1/10W	5%	RMC1/10T 331J	J24205331		1-	
R 4047	CHIPRES.	100k	1/10W	5%	RMC1/10T 104J	J24205104		1-	
R 4048	CHIPRES.	470	1/10W	5%	RMC1/10T 471J	J24205471		1-	
R 4049	CHIPRES.	100	1/10W	5%	RMC1/10T 101J	J24205101		1-	
R 4050	CHIPRES.	220	1/10W	5%	RMC1/10T 221J	J24205221		1-	
R 4051	CHIPRES.	470	1/10W	5%	RMC1/10T 471J	J24205471		1-	
R 4052	CHIPRES.	22k	1/10W	5%	RMC1/10T 223J	J24205223		1-	
R 4053	CHIPRES.	100	1/10W	5%	RMC1/10T 101J	J24205101		1-	
R 4054	CHIPRES.	4.7k	1/10W	5%	RMC1/10T 472J	J24205472		1-	

LOCAL Unit

Parts List

REF.	DESCRIPTION	VALUE	V/W	TOL.	MFR'S DESIG	YAESU P/N	VERS.	LOT.	LAY ADR
R 4055	CHIPRES.	150	1/10W	5%	RMC1/10T 151J	J24205151		1-	
R 4056	CHIPRES.	100k	1/10W	5%	RMC1/10T 104J	J24205104		1-	
R 4057	CHIPRES.	680	1/10W	5%	RMC1/10T 681J	J24205681		1-	
R 4058	CHIPRES.	2.2k	1/10W	5%	RMC1/10T 222J	J24205222		1-	
R 4059	CHIPRES.	100	1/10W	5%	RMC1/10T 101J	J24205101		1-	
R 4060	CHIPRES.	2.2k	1/10W	5%	RMC1/10T 222J	J24205222		1-	
R 4061	CHIPRES.	2.2k	1/10W	5%	RMC1/10T 222J	J24205222		1-	
R 4062	CHIPRES.	560	1/10W	5%	RMC1/10T 561J	J24205561		1-	
R 4063	CHIPRES.	100	1/10W	5%	RMC1/10T 101J	J24205101		1-	
R 4064	CHIPRES.	1k	1/10W	5%	RMC1/10T 102J	J24205102		1-	
R 4065	CHIPRES.	100k	1/10W	5%	RMC1/10T 104J	J24205104		1-	
R 4066	CHIPRES.	100k	1/10W	5%	RMC1/10T 104J	J24205104		1-	
R 4067	CHIPRES.	10k	1/10W	5%	RMC1/10T 103J	J24205103		1-	
R 4069	CHIPRES.	22k	1/10W	5%	RMC1/10T 223J	J24205223		1-	
R 4070	CHIPRES.	150	1/10W	5%	RMC1/10T 151J	J24205151		1-	
R 4071	CHIPRES.	220	1/10W	5%	RMC1/10T 221J	J24205221		1-	
R 4072	CHIPRES.	100	1/10W	5%	RMC1/10T 101J	J24205101		1-	
R 4073	CHIPRES.	390	1/10W	5%	RMC1/10T 391J	J24205391		1-	
R 4074	CHIPRES.	100k	1/10W	5%	RMC1/10T 104J	J24205104		1-	
R 4075	CHIPRES.	1k	1/10W	5%	RMC1/10T 102J	J24205102		1-	
R 4076	CHIPRES.	33k	1/10W	5%	RMC1/10T 333J	J24205333		1-	
R 4077	CHIPRES.	100k	1/10W	5%	RMC1/10T 104J	J24205104		1-	
R 4078	CHIPRES.	100	1/10W	5%	RMC1/10T 101J	J24205101		1-	
R 4079	CHIPRES.	100	1/10W	5%	RMC1/10T 101J	J24205101		1-	
R 4080	CHIPRES.	10k	1/10W	5%	RMC1/10T 103J	J24205103		1-	
R 4081	CHIPRES.	10k	1/10W	5%	RMC1/10T 103J	J24205103		1-	
R 4082	CHIPRES.	1.5k	1/10W	5%	RMC1/10T 152J	J24205152		1-	
R 4083	CHIPRES.	10k	1/10W	5%	RMC1/10T 103J	J24205103		1-	
R 4084	CHIPRES.	470	1/10W	5%	RMC1/10T 471J	J24205471		1-	
R 4085	CHIPRES.	470	1/10W	5%	RMC1/10T 471J	J24205471		1-	
R 4086	CHIPRES.	100	1/10W	5%	RMC1/10T 101J	J24205101		1-	
R 4088	CHIPRES.	2.2k	1/10W	5%	RMC1/10T 222J	J24205222		1-	
R 4089	CHIPRES.	1.5k	1/10W	5%	RMC1/10T 152J	J24205152		1-	
R 4090	CHIPRES.	100k	1/10W	5%	RMC1/10T 104J	J24205104		1-	
R 4091	CHIPRES.	6.8k	1/10W	5%	RMC1/10T 682J	J24205682		1-	
R 4092	CHIPRES.	390	1/10W	5%	RMC1/10T 391J	J24205391		1-	
R 4093	CHIPRES.	22k	1/10W	5%	RMC1/10T 223J	J24205223		1-	
R 4094	CHIPRES.	0	1/10W	5%	RMC1/10T 000J	J24205000		1-	
R 4095	CHIPRES.	33k	1/10W	5%	RMC1/10T 333J	J24205333		1-	
R 4096	CHIPRES.	150	1/10W	5%	RMC1/10T 151J	J24205151		1-	
R 4097	CHIPRES.	470	1/10W	5%	RMC1/10T 471J	J24205471		1-	
R 4098	CHIPRES.	100	1/10W	5%	RMC1/10T 101J	J24205101		1-	
R 4099	CHIPRES.	10k	1/10W	5%	RMC1/10T 103J	J24205103		1-	
R 4100	CHIPRES.	470	1/10W	5%	RMC1/10T 471J	J24205471		1-	
R 4101	CHIPRES.	100	1/10W	5%	RMC1/10T 101J	J24205101		1-	
R 4102	CHIPRES.	100	1/10W	5%	RMC1/10T 101J	J24205101		1-	
R 4103	CHIPRES.	10k	1/10W	5%	RMC1/10T 103J	J24205103		1-	
R 4104	CHIPRES.	100	1/10W	5%	RMC1/10T 101J	J24205101		1-	
R 4105	CHIPRES.	10k	1/10W	5%	RMC1/10T 103J	J24205103		1-	
R 4106	CHIPRES.	100	1/10W	5%	RMC1/10T 101J	J24205101		1-	
R 4107	CHIPRES.	10k	1/10W	5%	RMC1/10T 103J	J24205103		1-	
R 4108	CHIPRES.	100	1/10W	5%	RMC1/10T 101J	J24205101		1-	
R 4109	CHIPRES.	10k	1/10W	5%	RMC1/10T 103J	J24205103		1-	
R 4110	CHIPRES.	1k	1/10W	5%	RMC1/10T 102J	J24205102		1-	
R 4111	CHIPRES.	1k	1/10W	5%	RMC1/10T 102J	J24205102		1-	
R 4112	CHIPRES.	150k	1/10W	5%	RMC1/10T 154J	J24205154		1-	
R 4113	METAL FILM RES.	12	3W		ERG-3SJ120P 12	J22359037		1-	
R 4114	CHIPRES.	100	1/10W	5%	RMC1/10T 101J	J24205101		1-	
T 4001	COIL 07RF	61.44MHz			61.44M R12-M416A	L0021932		1-	
T 4002	COIL 07RF	69MHz			69.0M S-7G	L0021249		1-	
T 4003	COIL 07RF	69MHz			69.0M S-7G	L0021249		1-	
T 4004	COIL 07RF	69MHz			69.0M S-7G	L0021249		1-	
T 4005	COIL 07RF	69MHz			69.0M S-7G	L0021249		1-	
T 4006	COIL 07RF	61.44MHz			61.44M R12-M416A	L0021932		1-	
T 4007	COIL 07RF	61.44MHz			61.44M R12-M416A	L0021932		1-	
T 4008	COIL 07RF	8.67MHz			8.67M R12-K575A	L0022021		1-	
T 4009	COIL 07RF	8.67MHz			8.67M R12-K575A	L0022021		1-	
T 4010	COIL 07RF	2MHz			2.00M R12-5249A	L0020899		1-	

LOCAL Unit

Parts List

REF.	DESCRIPTION	VALUE	V/W	TOL.	MFR'S DESIG	YAESU P/N	VERS.	LOT.	LAYADR
TC4001	TRIMMERCAP.	10pF			ECV1ZW10X53T 10PF	K91000028		1-	
TC4002	TRIMMERCAP.	6pF			ECV1ZW06X53T 6PF	K91000055		1-	
TC4003	TRIMMERCAP.	6pF			ECV1ZW06X53T 6PF	K91000055		1-	
TC4004	TRIMMERCAP.	6pF			ECV1ZW06X53T 6PF	K91000055		1-	
TP4001	TERMINAL				TP-K IPS-1136	Q5000050		1-	
TP4002	TERMINAL				TP-K IPS-1136	Q5000050		1-	
TP4003	TERMINAL				TP-K IPS-1136	Q5000050		1-	
TP4004	TERMINAL				TP-K IPS-1136	Q5000050		1-	
TP4005	TERMINAL				TP-K IPS-1136	Q5000050		1-	
VR4001	POT.	470			RH063MCS2R 470B	J51794471		1-	
X 4001	XTAL HC-49/T	62.237MHz			62.237MHZ	H0103100		1-	
XF4001	XTAL FILTER				8.6M10A	H1102259		1-	
	SHIELD CASE				VCO	R0124120		1-	
	CASE COVER				VCO	R0124131		1-	
	LEAF SPRING					R0125240		1-	
	SHIELD CASE					R0131670A		1-	
	SHIELD CASE COVER					R0131640		1-	
	LEAF SPRING					R0140031		1-	

DDS-SUB Unit

Parts Layout

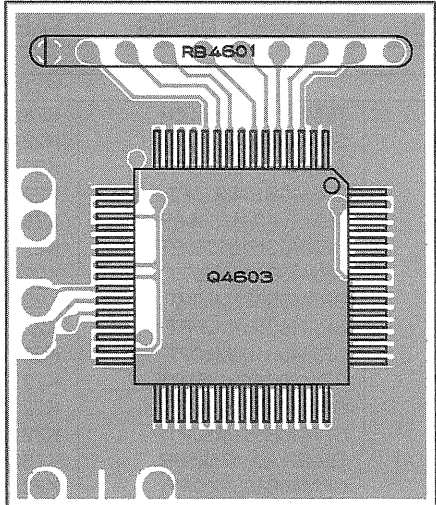

Side A

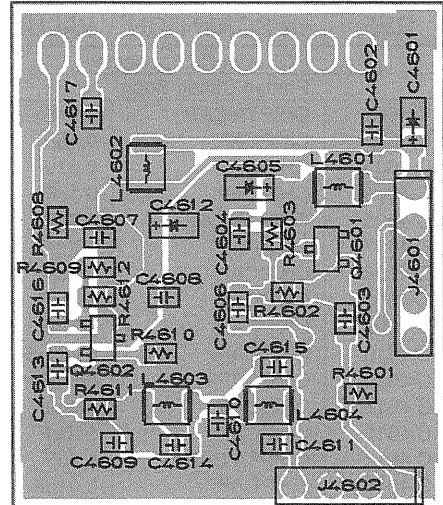

Side B

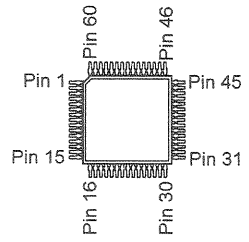

TC23SC030AF
(Q4603)

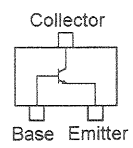

2SC2812 (L6)
(Q4601, 4602)

Circuit Diagram

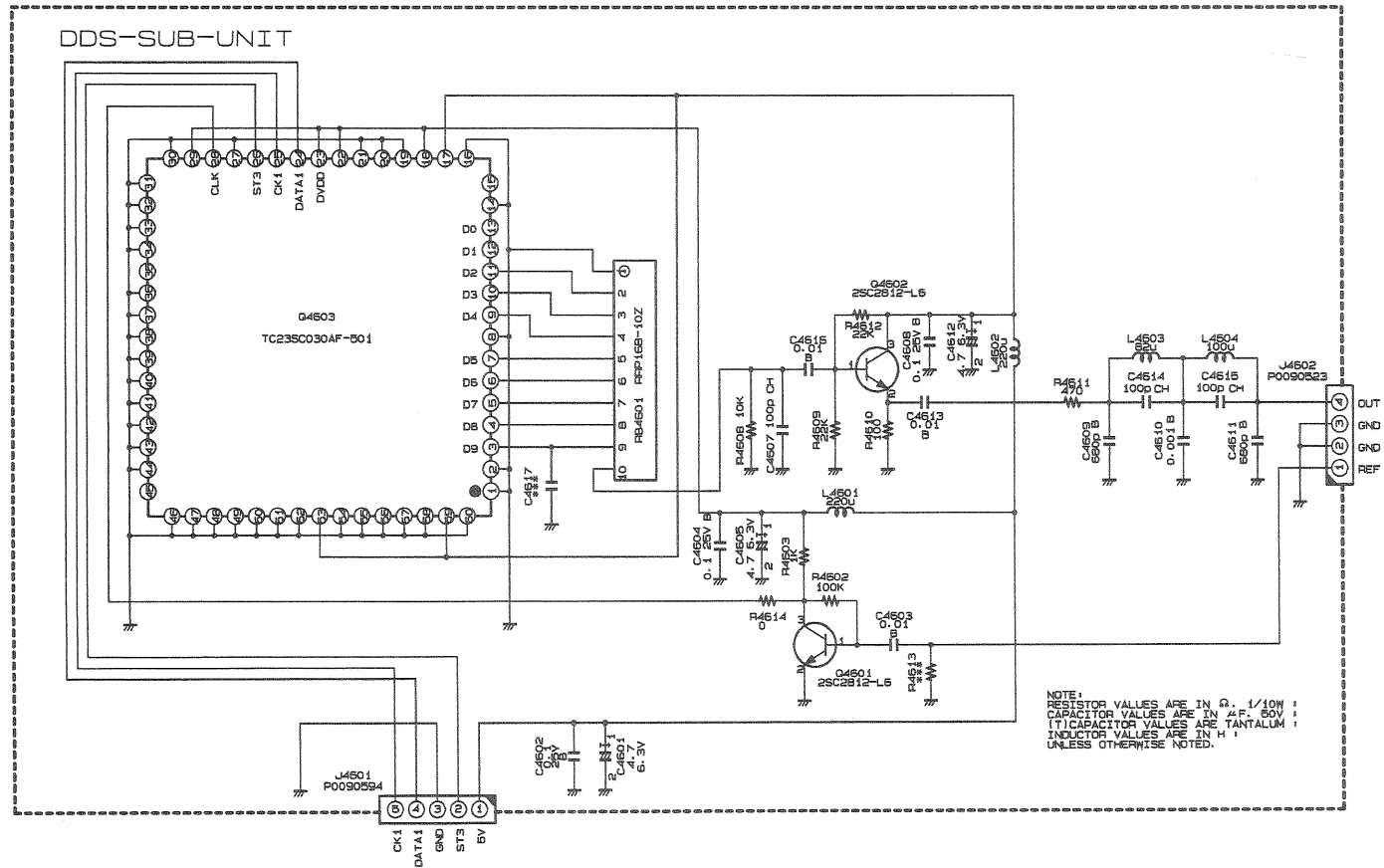

DDS-SUB Unit

Parts List

REF.	DESCRIPTION	VALUE	V/W	TOL.	MFR'S DESIG	YAESU P/N	VERS.	LOT.	LAY ADR
PCB with Components						CB1194001			
Printed Circuit Board						F3255102B			
C 4601	CHIPTA.CAP.	4.7uF	6.3V		TEMSVA0J475M-8R	K78080017		1-	
C 4602	CHIPCAP.	0.1uF	25V	B	GRM40B104M25PT	K22140811		1-	
C 4603	CHIPCAP.	0.01uF	50V	B	GRM40B103M50PT	K22170817		1-	
C 4604	CHIPCAP.	0.1uF	25V	B	GRM40B104M25PT	K22140811		1-	
C 4605	CHIPTA.CAP.	4.7uF	6.3V		TEMSVA0J475M-8R	K78080017		1-	
C 4607	CHIPCAP.	100pF	50V	CH	GRM40CH101J50PT	K22170235		1-	
C 4608	CHIPCAP.	0.1uF	25V	B	GRM40B104M25PT	K22140811		1-	
C 4609	CHIPCAP.	680pF	50V	B	GRM40B681M50PT	K22170803		1-	
C 4609	CHIPCAP.	560pF	50V	B	GRM40B561M50PT	K22170802		9-	
C 4610	CHIPCAP.	0.001uF	50V	B	GRM40B102M50PT	K22170805		1-	
C 4610	CHIPCAP.	680pF	50V	CH	GRM40CH681J50PT	K22170287		9-	
C 4611	CHIPCAP.	680pF	50V	B	GRM40B681M50PT	K22170803		1-	
C 4611	CHIPCAP.	560pF	50V	B	GRM40B561M50PT	K22170802		9-	
C 4612	CHIPTA.CAP.	4.7uF	6.3V		TEMSVA0J475M-8R	K78080017		1-	
C 4613	CHIPCAP.	0.01uF	50V	B	GRM40B103M50PT	K22170817		1-	
C 4614	CHIPCAP.	100pF	50V	CH	GRM40CH101J50PT	K22170235		1-	
C 4614	CHIPCAP.	68pF	50V	CH	GRM40CH680J50PT	K22170231		9-	
C 4615	CHIPCAP.	100pF	50V	CH	GRM40CH101J50PT	K22170235		1-	
C 4615	CHIPCAP.	27pF	50V	CH	GRM40CH270J50PT	K22170221		9-	
C 4616	CHIPCAP.	0.01uF	50V	B	GRM40B103M50PT	K22170817		1-	
J 4601	CONNECTOR				3022-05B	P0090594		1-	
J 4602	CONNECTOR				3022-04B	P0090523		1-	
L 4601	M.RFC	220uH			FLC32T-221J	L1690231		1-	
L 4602	M.RFC	220uH			FLC32T-221J	L1690231		1-	
L 4603	M.RFC	82uH			FLC32T-820J	L1690226		1-	
L 4604	M.RFC	100uH			FLC32T-101J	L1690227		1-	
Q 4601	TRANSISTOR				2SC2812L6-TA	G3328127F		1-	B
Q 4601	TRANSISTOR				2SC2812NL6-TB	G3328128F		8-	B
Q 4602	TRANSISTOR				2SC2812L6-TA	G3328127F		1-	B
Q 4602	TRANSISTOR				2SC2812NL6-TB	G3328128F		8-	B
Q 4603	IC				TC23SC030AF-501	G1090970		1-	A
R 4602	CHIPRES.	100k	1/10W	5%	RMC1/10T 104J	J24205104		1-	
R 4603	CHIPRES.	1k	1/10W	5%	RMC1/10T 102J	J24205102		1-	
R 4608	CHIPRES.	10k	1/10W	5%	RMC1/10T 103J	J24205103		1-	
R 4609	CHIPRES.	22k	1/10W	5%	RMC1/10T 223J	J24205223		1-	
R 4610	CHIPRES.	100	1/10W	5%	RMC1/10T 101J	J24205101		1-	
R 4611	CHIPRES.	470	1/10W	5%	RMC1/10T 471J	J24205471		1-	
R 4612	CHIPRES.	22k	1/10W	5%	RMC1/10T 223J	J24205223		1-	
R 4614	CHIPRES.	0	1/10W	5%	RMC1/10T 000J	J24205000		1-	
RB4601	BLOCK RES.				RRP16B-10Z-10K/20K	J40900181		1-	
	SHIELD CASE					R0131630		1-	

DDS-PLL Unit

Parts Layout

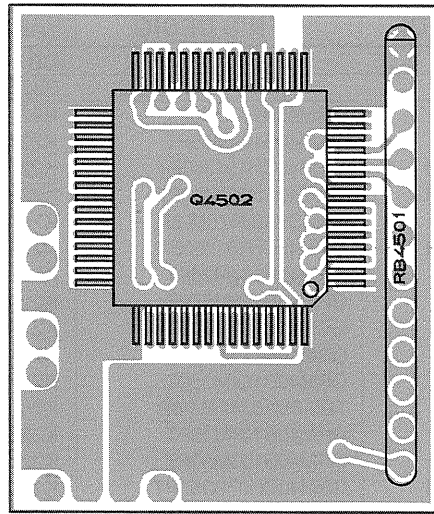

Side A

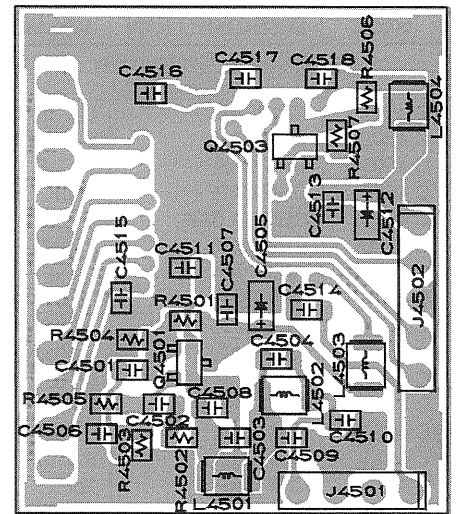

Side B

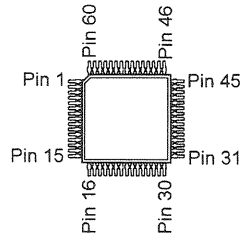

TC23SC030AF
(Q3501)

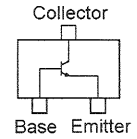

2SC2812 (L6)
(Q3502, 3503)

Circuit Diagram

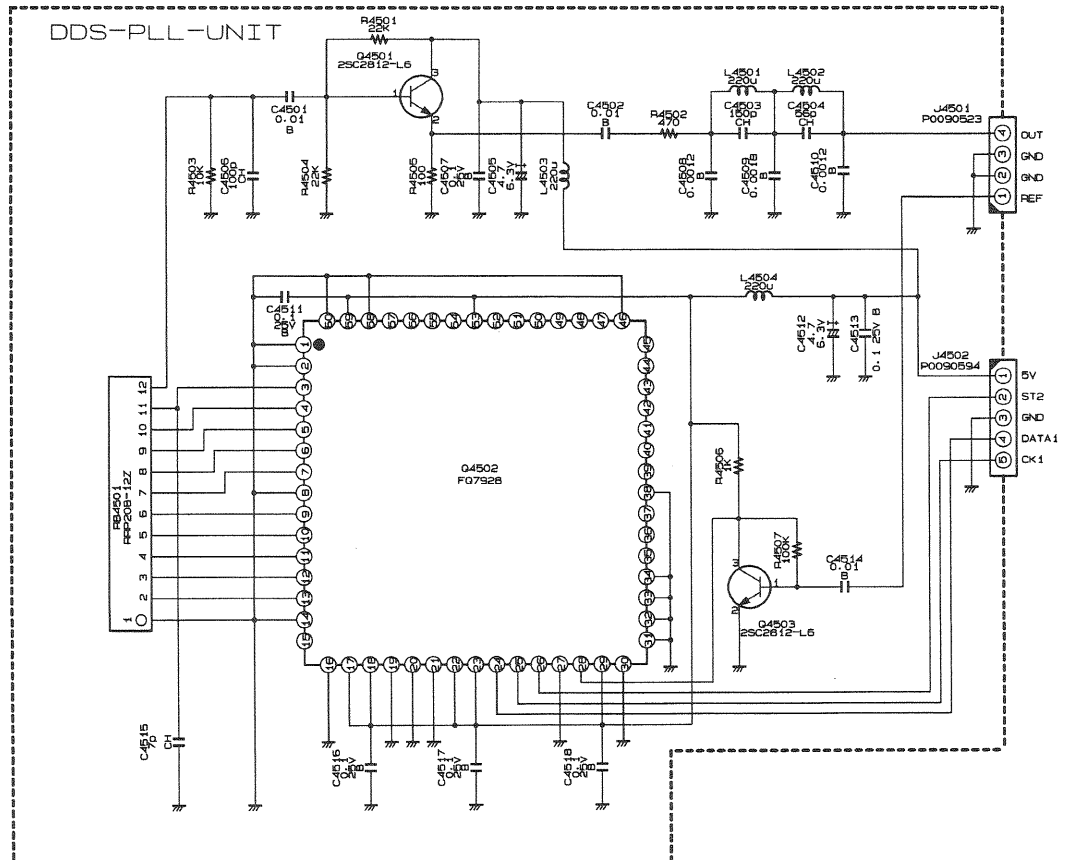

DDS-PLL Unit

Parts List

REF.	DESCRIPTION	VALUE	V/W	TOL.	MFR'S DESIG	YAESU P/N	VERS.	LOT.	LAY ADR	
PCB with Components						CB1193001				
Printed Circuit Board						F3255101B			1-	
C 4501	CHIPCAP.	0.01uF	50V	B	GRM40B103M50PT	K22170817		1-		
C 4502	CHIPCAP.	0.01uF	50V	B	GRM40B103M50PT	K22170817		1-		
C 4503	CHIPCAP.	150pF	50V	CH	GRM40CH151J50PT	K22170239		1-		
C 4504	CHIPCAP.	56pF	50V	CH	GRM40CH560J50PT	K22170229		1-		
C 4505	CHIPTA.CAP.	4.7uF	6.3V		TEMSVA0J475M-8R	K78080017		1-		
C 4506	CHIPCAP.	100pF	50V	CH	GRM40CH101J50PT	K22170235		1-		
C 4507	CHIPCAP.	0.1uF	25V	B	GRM40B104M25PT	K22140811		1-		
C 4508	CHIPCAP.	0.0012uF	50V	B	GRM40B122M50PT	K22170806		1-		
C 4509	CHIPCAP.	0.0018uF	50V	B	GRM40B182M50PT	K22170808		1-		
C 4510	CHIPCAP.	0.0012uF	50V	B	GRM40B122M50PT	K22170806		1-		
C 4511	CHIPCAP.	0.1uF	25V	B	GRM40B104M25PT	K22140811		1-		
C 4512	CHIPTA.CAP.	4.7uF	6.3V		TEMSVA0J475M-8R	K78080017		1-		
C 4513	CHIPCAP.	0.1uF	25V	B	GRM40B104M25PT	K22140811		1-		
C 4514	CHIPCAP.	0.01uF	50V	B	GRM40B103M50PT	K22170817		1-		
C 4515	CHIPCAP.	7pF	50V	CH	GRM40CH070D50PT	K22170208		1-		
C 4516	CHIPCAP.	0.1uF	25V	B	GRM40B104M25PT	K22140811		1-		
C 4517	CHIPCAP.	0.1uF	25V	B	GRM40B104M25PT	K22140811		1-		
C 4518	CHIPCAP.	0.1uF	25V	B	GRM40B104M25PT	K22140811		1-		
J 4501	CONNECTOR				3022-04B	P0090523		1-		
J 4502	CONNECTOR				3022-05B	P0090594		1-		
L 4501	M.RFC	220uH			FLC32T-221J	L1690231		1-		
L 4502	M.RFC	220uH			FLC32T-221J	L1690231		1-		
L 4503	M.RFC	220uH			FLC32T-221J	L1690231		1-		
L 4504	M.RFC	220uH			FLC32T-221J	L1690231		1-		
Q 4501	TRANSISTOR				2SC2812L6-TA	G3328127F		1-	B	
Q 4501	TRANSISTOR				2SC2812NL6-TB	G3328128F		8-	B	
Q 4502	IC				FQ7928	G1092005		1-	A	
Q 4503	TRANSISTOR				2SC2812L6-TA	G3328127F		1-	B	
Q 4503	TRANSISTOR				2SC2812NL6-TB	G3328128F		8-	B	
R 4501	CHIPRES.	22k	1/10W	5%	RMC1/10T 223J	J24205223		1-		
R 4502	CHIPRES.	470	1/10W	5%	RMC1/10T 471J	J24205471		1-		
R 4503	CHIPRES.	10k	1/10W	5%	RMC1/10T 103J	J24205103		1-		
R 4504	CHIPRES.	22k	1/10W	5%	RMC1/10T 223J	J24205223		1-		
R 4505	CHIPRES.	100	1/10W	5%	RMC1/10T 101J	J24205101		1-		
R 4506	CHIPRES.	1k	1/10W	5%	RMC1/10T 102J	J24205102		1-		
R 4507	CHIPRES.	100k	1/10W	5%	RMC1/10T 104J	J24205104		1-		
RB4501	BLOCK RES.				RRP20B-12Z-10K/20K	J40900180		1-		
	SHIELD CASE					R0131630		1-		

REF Unit

Parts Layout

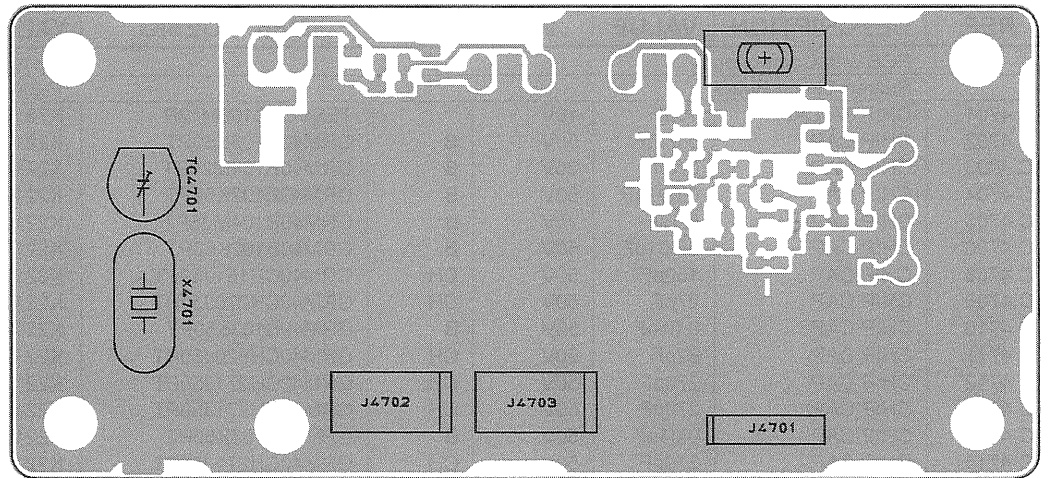

Side A

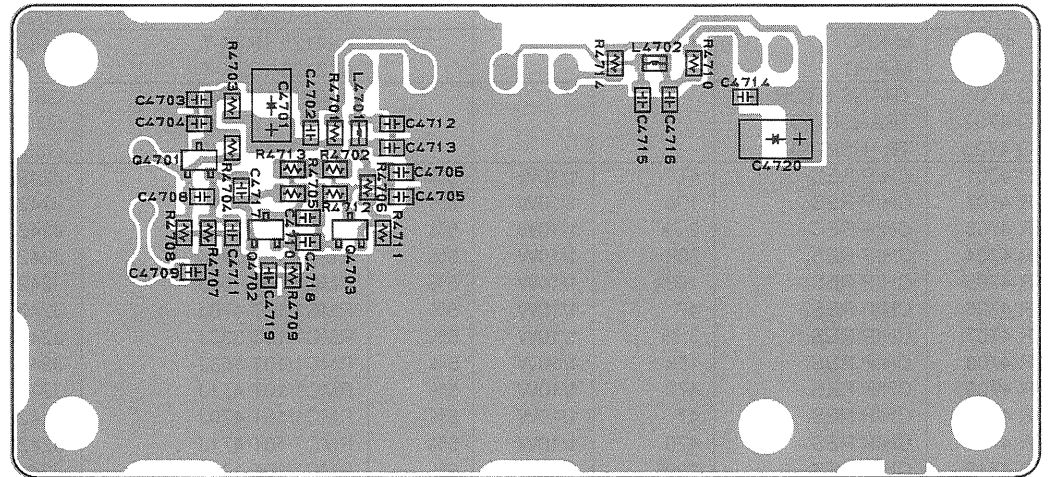

Side B

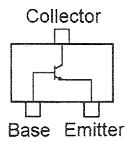

2SC2714 (L6)
(Q4701, 4702, 4703)

Parts Layout

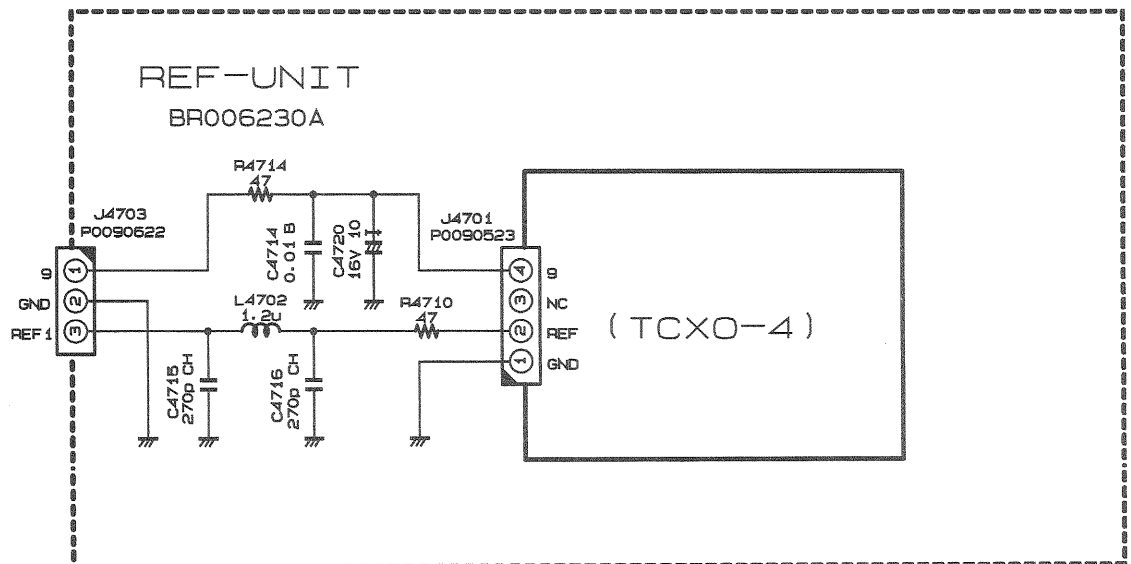

REF Unit

Parts List

REF.	DESCRIPTION	VALUE	V/W	TOL.	MFR'S DESIG	YAESU P/N	VERS.	LOT.	LAY ADR
PCB with Componentc						CB1195001			
Printed Circuit Board						FR006230A			
C 4701	CHIP TA.CAP.	10uF	16V		TESVC1C106M12R	K78120011		1	
C 4702	CHIP CAP.	0.01uF	50V	B	GRM40B103K50PT	K22170826		1	
C 4703	CHIP CAP.	0.1uF	25V	B	GRM40B104M25PT	K22140811		1	
C 4704	CHIP CAP.	0.001uF	50V	B	GRM40B102K50PT	K22170825		1	
C 4705	CHIP CAP.	0.1uF	25V	B	GRM40B104M25PT	K22140811		1	
C 4706	CHIP CAP.	0.001uF	50V	B	GRM40B102K50PT	K22170825		1	
C 4708	CHIP CAP.	150pF	50V	CH	GRM40CH151J50PT	K22170239		1	
C 4709	CHIP CAP.	27pF	50V	CH	GRM40CH270J50PT	K22170221		1	
C 4710	CHIP CAP.	0.01uF	50V	B	GRM40B103K50PT	K22170826		1	
C 4711	CHIP CAP.	82pF	50V	CH	GRM40CH820J50PT	K22170233		1	
C 4712	CHIP CAP.	270pF	50V	CH	GRM40CH271J50PT	K22170245		1	
C 4713	CHIP CAP.	270pF	50V	CH	GRM40CH271J50PT	K22170245		1	
C 4714	CHIP CAP.	0.01uF	50V	B	GRM40B103K50PT	K22170826		1	
C 4715	CHIP CAP.	270pF	50V	CH	GRM40CH271J50PT	K22170245		1	
C 4716	CHIP CAP.	270pF	50V	CH	GRM40CH271J50PT	K22170245		1	
C 4717	CHIP CAP.	4pF	50V	CH	GRM40CH040C50PT	K22170205		1	
C 4720	CHIP TA.CAP.	10uF	16V		TESVC1C106M12R	K78120011		1	
J 4701	CONNECTOR				3022-04B	P0090523		1	
J 4702	CONNECTOR				SC25-03WS	P0090622		1	
J 4703	CONNECTOR				SC25-03WS	P0090622		1	
L 4701	M.RFC	1.2uH			LK2125 1R2K-T	L1690320		1	
L 4702	M.RFC	1.2uH			LK2125 1R2K-T	L1690320		1	
Q 4701	TRANSISTOR				2SC2714YTE85R	G3327147Y		1	B
Q 4702	TRANSISTOR				2SC2714YTE85R	G3327147Y		1	B
Q 4703	TRANSISTOR				2SC2714YTE85R	G3327147Y		1	B
R 4701	CHIP RES.	47	1/10W	5%	RMC1/10T 470J	J24205470		1	
R 4702	CHIP RES.	100	1/10W	5%	RMC1/10T 101J	J24205101		1	
R 4703	CHIP RES.	2.2k	1/10W	5%	RMC1/10T 222J	J24205222		1	
R 4704	CHIP RES.	33k	1/10W	5%	RMC1/10T 333J	J24205333		1	
R 4705	CHIP RES.	100k	1/10W	5%	RMC1/10T 104J	J24205104		1	
R 4706	CHIP RES.	47	1/10W	5%	RMC1/10T 470J	J24205470		1	
R 4707	CHIP RES.	3.3k	1/10W	5%	RMC1/10T 332J	J24205332		1	
R 4708	CHIP RES.	15k	1/10W	5%	RMC1/10T 153J	J24205153		1	
R 4709	CHIP RES.	470	1/10W	5%	RMC1/10T 471J	J24205471		1	
R 4710	CHIP RES.	47	1/10W	5%	RMC1/10T 470J	J24205470		1	
R 4711	CHIP RES.	470	1/10W	5%	RMC1/10T 471J	J24205471		1	
R 4712	CHIP RES.	100k	1/10W	5%	RMC1/10T 104J	J24205104		1	
R 4713	CHIP RES.	2.2k	1/10W	5%	RMC1/10T 222J	J24205222		1	
R 4714	CHIP RES.	47	1/10W	5%	RMC1/10T 470J	J24205470		1	
TC4701	TRIMMER CAP.	10pF			TZ03Z100FR169 10PF	K91000185		1	
X 4701	XTAL HC-49/U	10.48576MHZ			10.48576MHZ	H0102990		1	
Z 4701	CARD SPACER				WLS-04-0	S6000191		1	

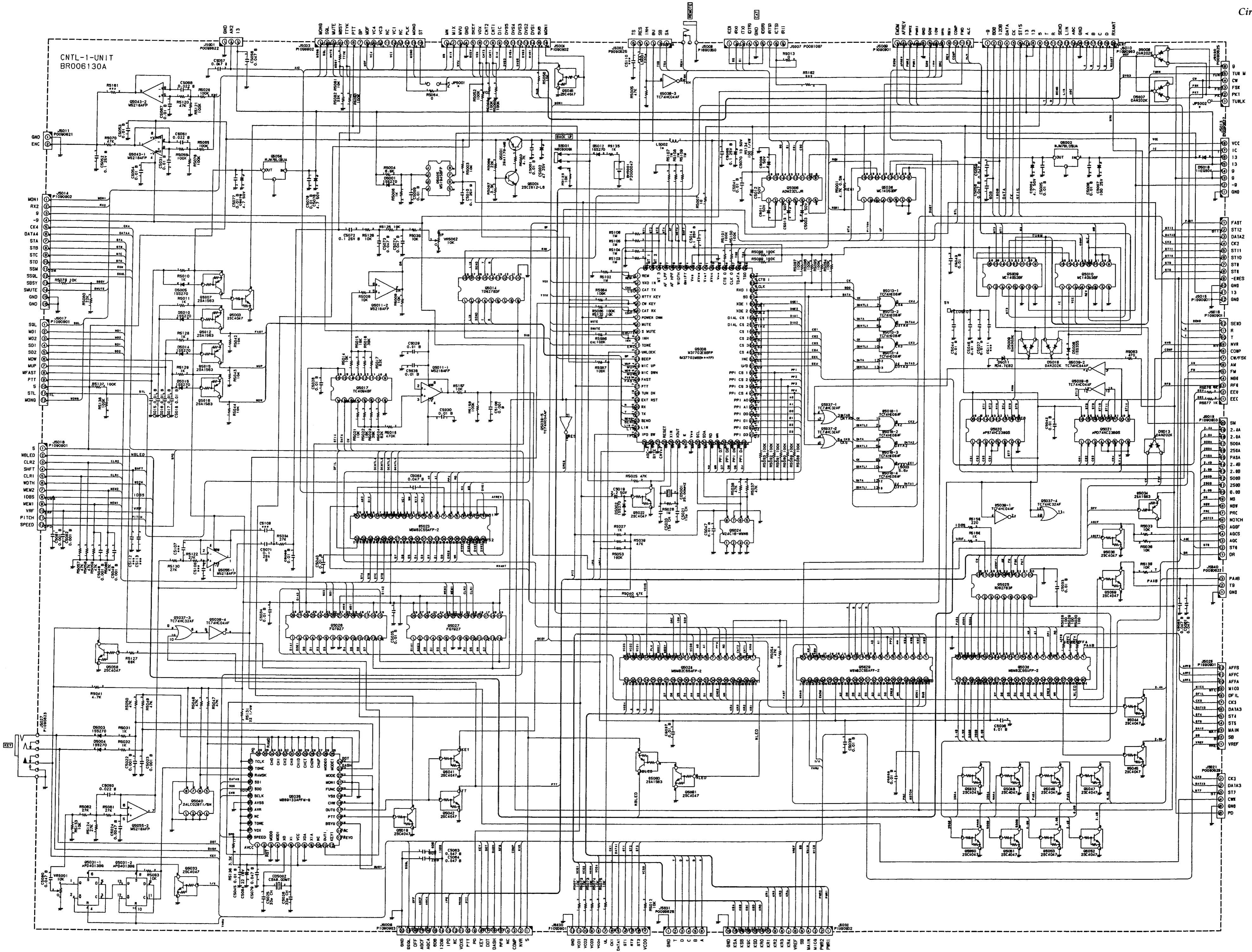

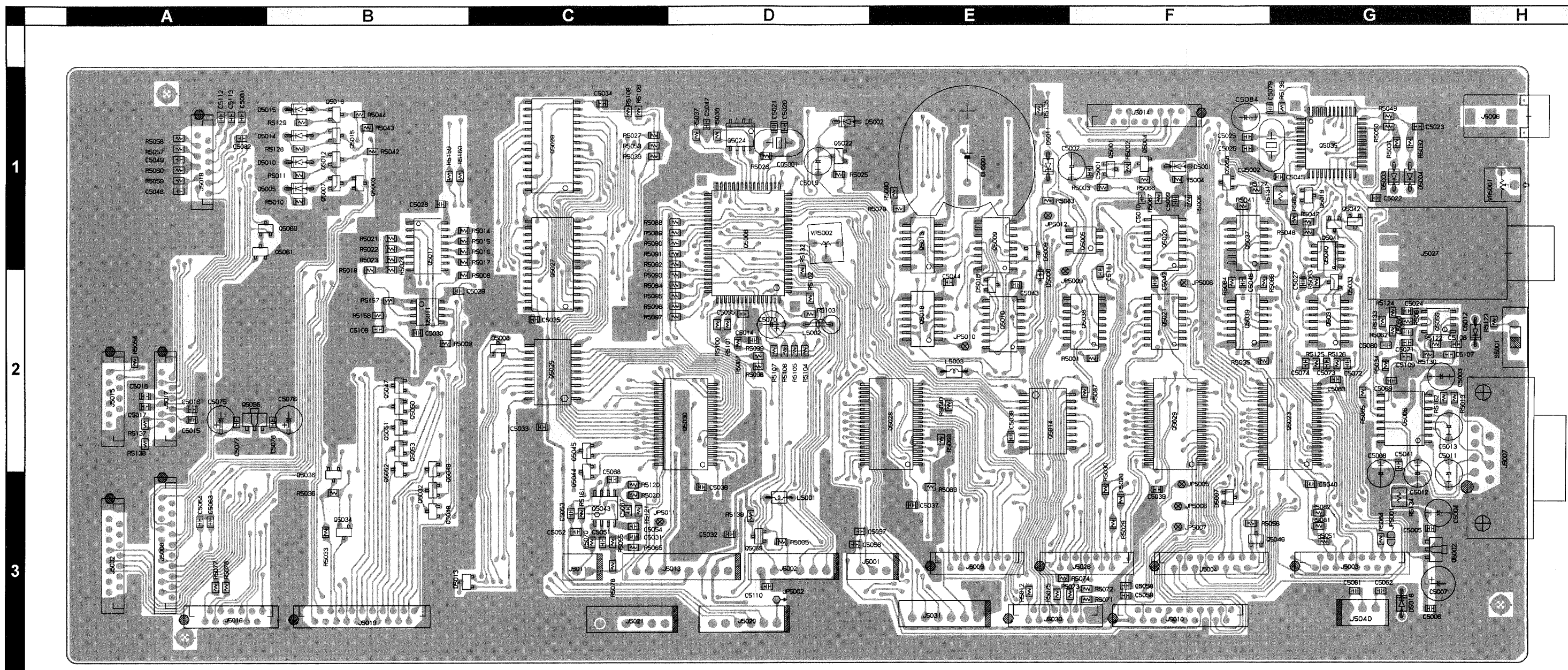

Side A

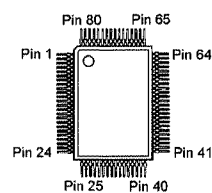

M37702E8BFP
(Q5008)

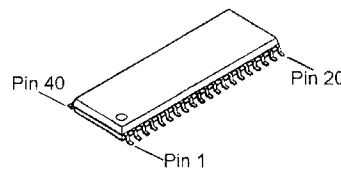

M5M82C55AFP
(Q5023, 50228,
5029, 5030)

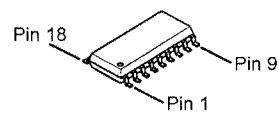

TD62783F
(Q5014, 5025)

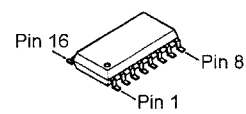

MC14053BFR1
(Q5009, 5010, 5038)
μPD74HC238GS
(Q5020, 5021)

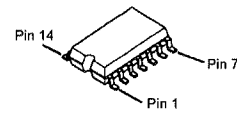

TC4094BF
(Q5017)
TC74HC04AF
(Q5039)

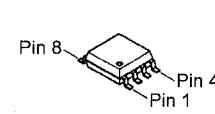

M51945BFP
(Q5005)
M5218AFP
(Q5011, 5043, 5055)

M24C16-WMN6T
(Q5024)

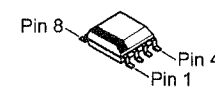

24LC02BTI
(Q5040)

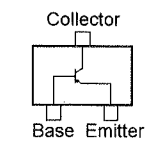

2SA1179 (M6)
(Q5001)

2SC2812 (L6)
(Q5004)

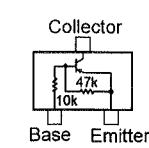

2SA1563 (RL)
(Q5007, 5012, 5015,
5016, 5034, 5060)

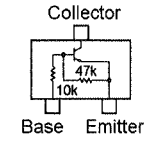

2SC4047 (ZY)
(Q5003, 5019, 505022,
5032, 5033, 5036, 5041,
5042, 5044, 5045, 5046,
5047, 5048, 5049, 5050,
5051, 5052, 5053, 5058,
5059, 5061)

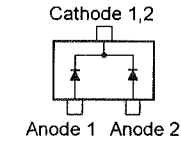

DAN202K (N)
(D5007, 5008,
5009, 5013, 5016)

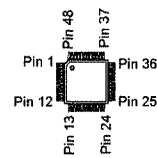

MB89133APFM
(Q5035)

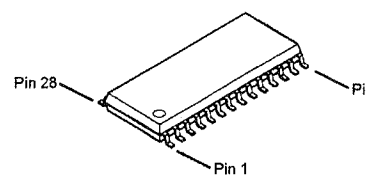

FQ7927
(Q5026, 5027)

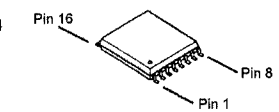

ADM232LJR
(Q5006)

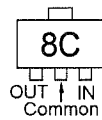

NJM78L05 (8C)
(Q5002, 5056)

TC74HC32AF
(Q5037)
μPD4013BG
(Q5031)

CNTL-1 Unit (Lot. 1~)

Parts Layout

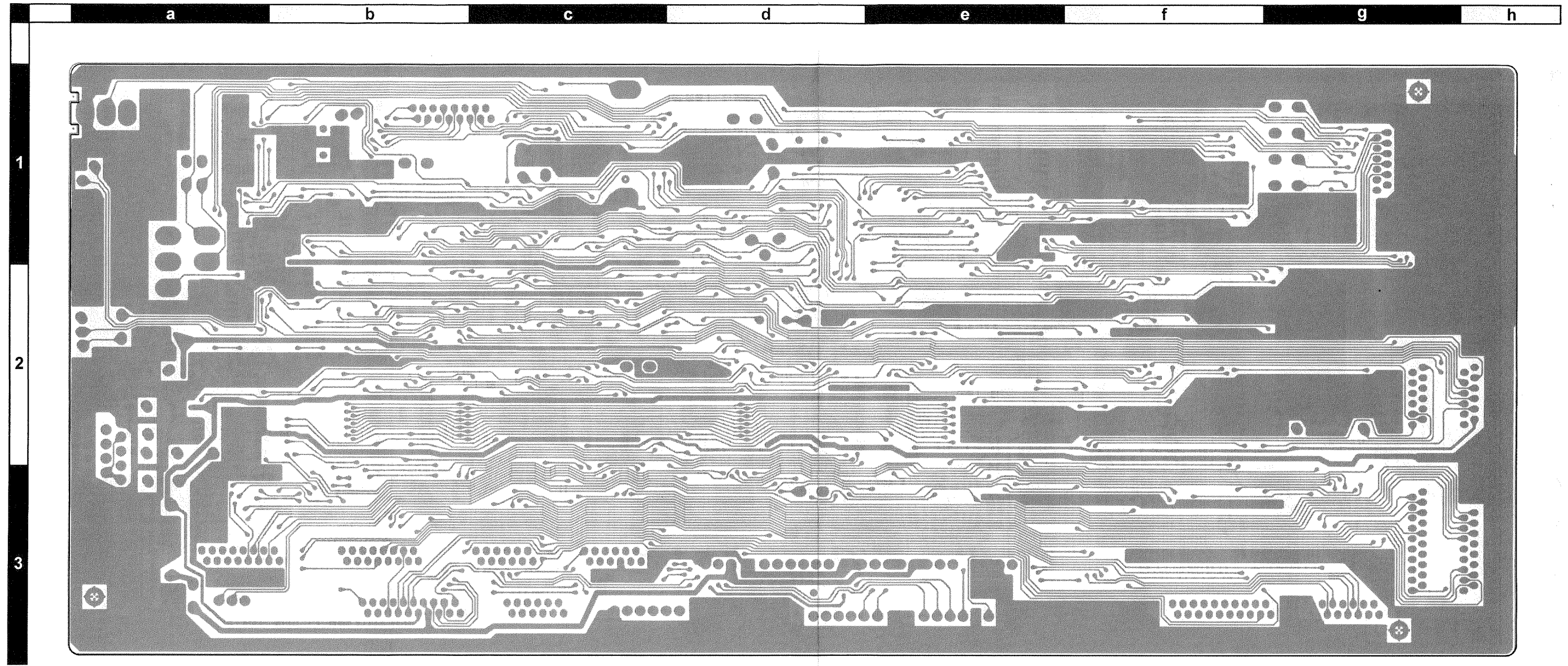

Side B

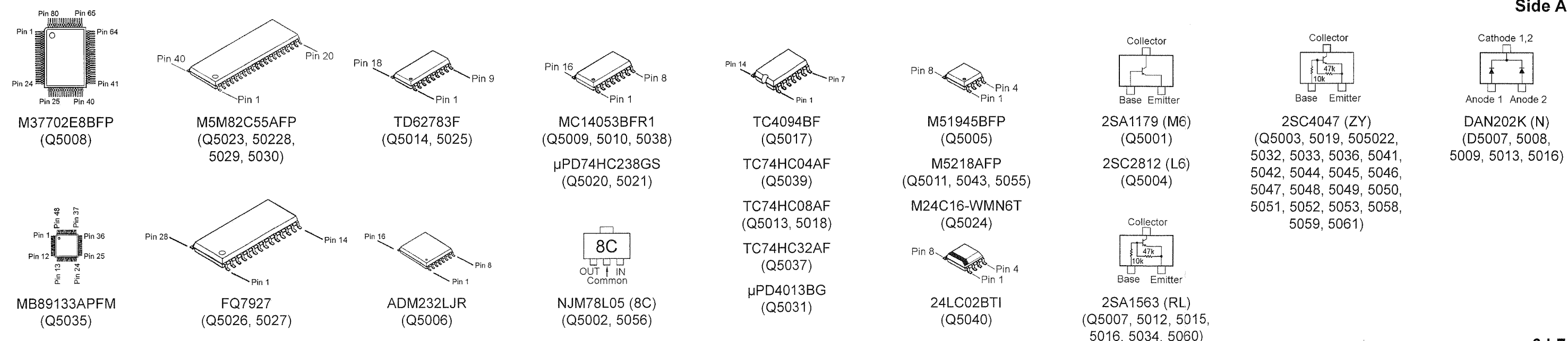
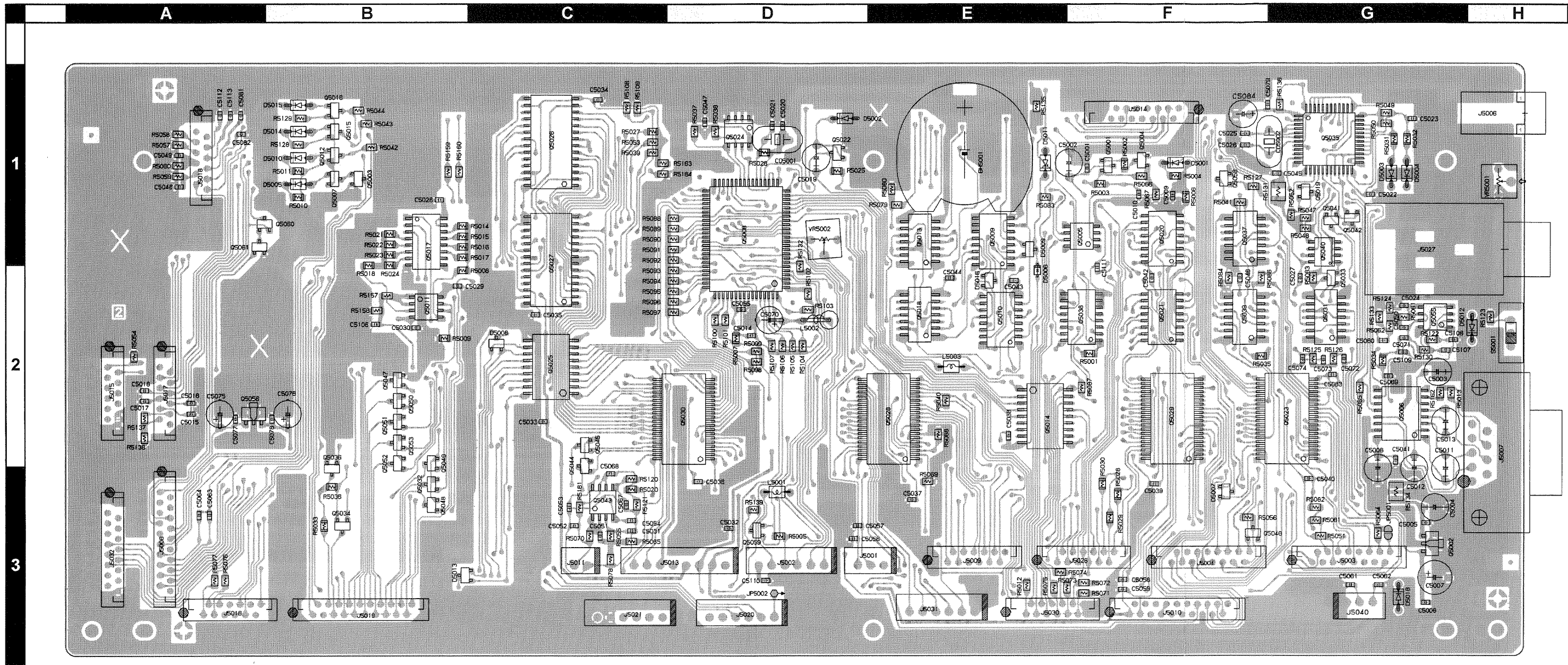

CNTL-1 Unit (Lot. 31~)

Parts Layout

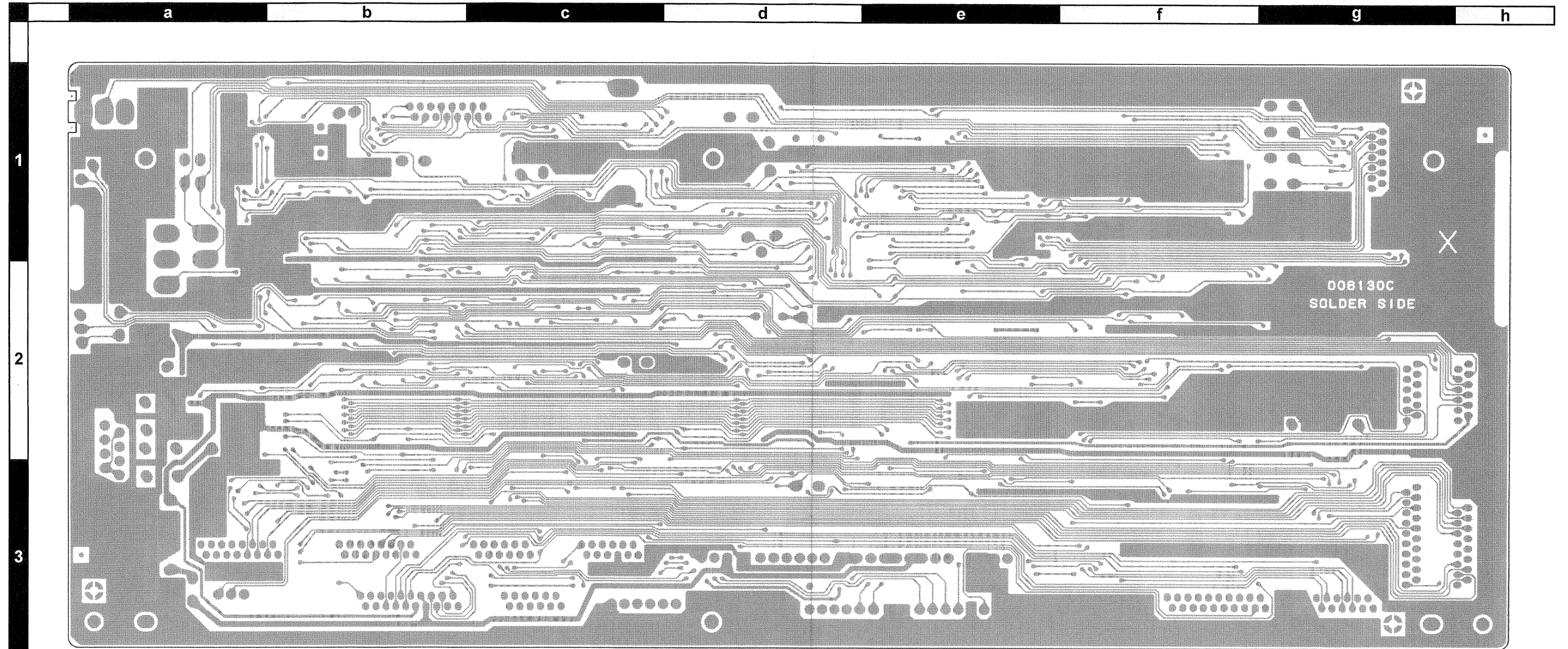

Side B

REF.	DESCRIPTION	VALUE	V/W	TOL.	MFR'S DESIG	YAESU P/N	VERS.	LOT.	LAYADR
	PCB with Components					CB1360001	W/ CE LABEL		
	PCB with Components					CB1360002	W/ CE LABEL		
	Printed Circuit Board					FR006130A		1-	
	Printed Circuit Board					FR006130C		31-	
BH5001	BATT.HOLDER				HL32-A2	P2000047		1-	
C 5001	CHIP CAP.	0.01uF	50V	B	GRM40B103M50PT	K22170817		1-	
C 5001	CHIP CAP.	0.01uF	50V	B	GRM39B103M50PT	K22174823		31-	
C 5002	AL.ELECTRO.CAP.	47uF	25V		25V470M5X11TR5	K46140004		1-	
C 5003	AL.ELECTRO.CAP.	1uF	50V		50V010M5X11TR5	K46170017		1-	
C 5004	AL.ELECTRO.CAP.	4.7uF	50V		50V4R7M5X11TR5	K46170020		1-	
C 5005	CHIP CAP.	0.01uF	50V	B	GRM40B103M50PT	K22170817		1-	
C 5005	CHIP CAP.	0.01uF	50V	B	GRM39B103M50PT	K22174823		31-	
C 5006	CHIP CAP.	0.01uF	50V	B	GRM40B103M50PT	K22170817		1-	
C 5006	CHIP CAP.	0.01uF	50V	B	GRM39B103M50PT	K22174823		31-	
C 5007	AL.ELECTRO.CAP.	100uF	25V		25V101M6X11TR5	K46140005		1-	
C 5008	AL.ELECTRO.CAP.	1uF	50V		50V010M5X11TR5	K46170017		1-	
C 5009	CHIP CAP.	0.01uF	50V	B	GRM40B103M50PT	K22170817		1-	
C 5009	CHIP CAP.	0.01uF	50V	B	GRM39B103M50PT	K22174823		31-	
C 5010	CHIP CAP.	0.1uF	25V	B	GRM40B104M25PT	K22140811		1-	
C 5010	CHIP CAP.	0.1uF	25V	F	GRM39F104Z25PT	K22145001		31-	
C 5011	AL.ELECTRO.CAP.	1uF	50V		50V010M5X11TR5	K46170017		1-	
C 5012	AL.ELECTRO.CAP.	1uF	50V		50V010M5X11TR5	K46170017		1-	
C 5013	AL.ELECTRO.CAP.	1uF	50V		50V010M5X11TR5	K46170017		1-	
C 5014	CHIP CAP.	0.1uF	25V	B	GRM40B104M25PT	K22140811		1-	
C 5014	CHIP CAP.	0.1uF	25V	F	GRM39F104Z25PT	K22145001		31-	
C 5015	CHIP CAP.	0.01uF	50V	B	GRM40B103M50PT	K22170817		1-	
C 5015	CHIP CAP.	0.01uF	50V	B	GRM39B103M50PT	K22174823		31-	
C 5016	CHIP CAP.	0.01uF	50V	B	GRM40B103M50PT	K22170817		1-	
C 5016	CHIP CAP.	0.01uF	50V	B	GRM39B103M50PT	K22174823		31-	
C 5017	CHIP CAP.	0.01uF	50V	B	GRM40B103M50PT	K22170817		1-	
C 5017	CHIP CAP.	0.01uF	50V	B	GRM39B103M50PT	K22174823		31-	
C 5018	CHIP CAP.	0.01uF	50V	B	GRM40B103M50PT	K22170817		1-	
C 5018	CHIP CAP.	0.01uF	50V	B	GRM39B103M50PT	K22174823		31-	
C 5019	AL.ELECTRO.CAP.	2.2uF	50V		50V2R2M5X11TR5	K46170018		1-	
C 5020	CHIP CAP.	15pF	50V	CH	GRM40CH150J50PT	K22170215		1-	
C 5020	CHIP CAP.	15pF	50V	CH	GRM39CH150J50PT	K22174215		31-	
C 5021	CHIP CAP.	15pF	50V	CH	GRM40CH150J50PT	K22170215		1-	
C 5021	CHIP CAP.	15pF	50V	CH	GRM39CH150J50PT	K22174215		31-	
C 5022	CHIP CAP.	0.001uF	50V	B	GRM40B102M50PT	K22170805		1-	
C 5022	CHIP CAP.	0.001uF	50V	B	GRM39B102K50PT	K22174821		31-	
C 5023	CHIP CAP.	0.001uF	50V	B	GRM40B102M50PT	K22170805		1-	
C 5023	CHIP CAP.	0.001uF	50V	B	GRM39B102K50PT	K22174821		31-	
C 5024	CHIP CAP.	0.0047uF	50V	B	GRM40B472M50PT	K22170813		1-	
C 5024	CHIP CAP.	0.0047uF	50V	B	GRM39B472K50PT	K22174833		31-	
C 5025	CHIP CAP.	33pF	50V	CH	GRM40CH330J50PT	K22170223		1-	
C 5025	CHIP CAP.	33pF	50V	CH	GRM39CH330J50PT	K22174223		31-	
C 5026	CHIP CAP.	33pF	50V	CH	GRM40CH330J50PT	K22170223		1-	
C 5026	CHIP CAP.	33pF	50V	CH	GRM39CH330J50PT	K22174223		31-	
C 5027	CHIP CAP.	0.01uF	50V	B	GRM40B103M50PT	K22170817		1-	
C 5027	CHIP CAP.	0.01uF	50V	B	GRM39B103M50PT	K22174823		31-	
C 5028	CHIP CAP.	0.01uF	50V	B	GRM40B103M50PT	K22170817		1-	
C 5028	CHIP CAP.	0.01uF	50V	B	GRM39B103M50PT	K22174823		31-	
C 5029	CHIP CAP.	0.01uF	50V	B	GRM40B103M50PT	K22170817		1-	
C 5029	CHIP CAP.	0.01uF	50V	B	GRM39B103M50PT	K22174823		31-	
C 5030	CHIP CAP.	0.01uF	50V	B	GRM40B103M50PT	K22170817		1-	
C 5030	CHIP CAP.	0.01uF	50V	B	GRM39B103M50PT	K22174823		31-	
C 5031	CHIP CAP.	0.01uF	50V	B	GRM40B103M50PT	K22170817		1-	
C 5031	CHIP CAP.	0.01uF	50V	B	GRM39B103M50PT	K22174823		31-	
C 5032	CHIP CAP.	0.01uF	50V	B	GRM40B103M50PT	K22170817		1-	
C 5032	CHIP CAP.	0.01uF	50V	B	GRM39B103M50PT	K22174823		31-	
C 5033	CHIP CAP.	0.01uF	50V	B	GRM40B103M50PT	K22170817		1-	
C 5033	CHIP CAP.	0.01uF	50V	B	GRM39B103M50PT	K22174823		31-	
C 5034	CHIP CAP.	0.01uF	50V	B	GRM40B103M50PT	K22170817		1-	
C 5034	CHIP CAP.	0.01uF	50V	B	GRM39B103M50PT	K22174823		31-	
C 5035	CHIP CAP.	0.01uF	50V	B	GRM40B103M50PT	K22170817		1-	
C 5035	CHIP CAP.	0.01uF	50V	B	GRM39B103M50PT	K22174823		31-	
C 5036	CHIP CAP.	0.01uF	50V	B	GRM40B103M50PT	K22170817		1-	
C 5036	CHIP CAP.	0.01uF	50V	B	GRM39B103M50PT	K22174823		31-	

CNTL-1 Unit

Parts List

REF.	DESCRIPTION	VALUE	V/W	TOL.	MFR'S DESIG	YAESU P/N	VERS.	LOT.	LAYADR
C 5037	CHIP CAP.	0.01uF	50V	B	GRM40B103M50PT	K22170817		1-	
C 5037	CHIP CAP.	0.01uF	50V	B	GRM39B103M50PT	K22174823		31-	
C 5038	CHIP CAP.	0.01uF	50V	B	GRM40B103M50PT	K22170817		1-	
C 5038	CHIP CAP.	0.01uF	50V	B	GRM39B103M50PT	K22174823		31-	
C 5039	CHIP CAP.	0.01uF	50V	B	GRM40B103M50PT	K22170817		1-	
C 5039	CHIP CAP.	0.01uF	50V	B	GRM39B103M50PT	K22174823		31-	
C 5040	CHIP CAP.	0.01uF	50V	B	GRM40B103M50PT	K22170817		1-	
C 5040	CHIP CAP.	0.01uF	50V	B	GRM39B103M50PT	K22174823		31-	
C 5041	CHIP CAP.	0.01uF	50V	B	GRM40B103M50PT	K22170817		1-	
C 5041	CHIP CAP.	0.01uF	50V	B	GRM39B103M50PT	K22174823		31-	
C 5042	CHIP CAP.	0.01uF	50V	B	GRM40B103M50PT	K22170817		1-	
C 5042	CHIP CAP.	0.01uF	50V	B	GRM39B103M50PT	K22174823		31-	
C 5043	CHIP CAP.	0.01uF	50V	B	GRM40B103M50PT	K22170817		1-	
C 5043	CHIP CAP.	0.01uF	50V	B	GRM39B103M50PT	K22174823		31-	
C 5044	CHIP CAP.	0.01uF	50V	B	GRM40B103M50PT	K22170817		1-	
C 5044	CHIP CAP.	0.01uF	50V	B	GRM39B103M50PT	K22174823		31-	
C 5045	CHIP CAP.	0.01uF	50V	B	GRM40B103M50PT	K22170817		1-	
C 5045	CHIP CAP.	0.01uF	50V	B	GRM39B103M50PT	K22174823		31-	
C 5046	CHIP CAP.	0.01uF	50V	B	GRM40B103M50PT	K22170817		1-	
C 5046	CHIP CAP.	0.01uF	50V	B	GRM39B103M50PT	K22174823		31-	
C 5047	CHIP CAP.	0.01uF	50V	B	GRM40B103M50PT	K22170817		1-	
C 5047	CHIP CAP.	0.01uF	50V	B	GRM39B103M50PT	K22174823		31-	
C 5048	CHIP CAP.	0.001uF	50V	B	GRM40B102M50PT	K22170805		1-	
C 5048	CHIP CAP.	0.001uF	50V	B	GRM39B102K50PT	K22174821		31-	
C 5049	CHIP CAP.	0.001uF	50V	B	GRM40B102M50PT	K22170805		1-	
C 5049	CHIP CAP.	0.001uF	50V	B	GRM39B102K50PT	K22174821		31-	
C 5050	CHIP CAP.	0.022uF	50V	B	GRM40B223M50PT	K22170821		1-	
C 5050	CHIP CAP.	0.022uF	25V	B	GRM39B223K25PT	K22144807		31-	
C 5051	CHIP CAP.	0.022uF	50V	B	GRM40B223M50PT	K22170821		1-	
C 5051	CHIP CAP.	0.022uF	25V	B	GRM39B223K25PT	K22144807		31-	
C 5052	CHIP CAP.	0.1uF	25V	B	GRM40B104M25PT	K22140811		1-	
C 5052	CHIP CAP.	0.1uF	25V	F	GRM39F104Z25PT	K22145001		31-	
C 5053	CHIP CAP.	0.01uF	50V	B	GRM40B103M50PT	K22170817		1-	
C 5053	CHIP CAP.	0.01uF	50V	B	GRM39B103M50PT	K22174823		31-	
C 5054	CHIP CAP.	0.01uF	50V	B	GRM40B103M50PT	K22170817		1-	
C 5054	CHIP CAP.	0.01uF	50V	B	GRM39B103M50PT	K22174823		31-	
C 5055	CHIP CAP.	0.1uF	25V	B	GRM40B104M25PT	K22140811		1-	
C 5055	CHIP CAP.	0.1uF	25V	F	GRM39F104Z25PT	K22145001		31-	
C 5056	CHIP CAP.	0.047uF	50V	B	GRM40B473M50PT	K22170823		1-	
C 5056	CHIP CAP.	0.047uF	25V	F	GRM39F473Z25PT	K22145002		31-	
C 5057	CHIP CAP.	0.047uF	50V	B	GRM40B473M50PT	K22170823		1-	
C 5057	CHIP CAP.	0.047uF	25V	F	GRM39F473Z25PT	K22145002		31-	
C 5058	CHIP CAP.	0.047uF	50V	B	GRM40B473M50PT	K22170823		1-	
C 5058	CHIP CAP.	0.047uF	25V	F	GRM39F473Z25PT	K22145002		31-	
C 5059	CHIP CAP.	0.047uF	50V	B	GRM40B473M50PT	K22170823		1-	
C 5059	CHIP CAP.	0.047uF	25V	F	GRM39F473Z25PT	K22145002		31-	
C 5061	CHIP CAP.	0.047uF	50V	B	GRM40B473M50PT	K22170823		1-	
C 5061	CHIP CAP.	0.047uF	25V	F	GRM39F473Z25PT	K22145002		31-	
C 5062	CHIP CAP.	0.047uF	50V	B	GRM40B473M50PT	K22170823		1-	
C 5062	CHIP CAP.	0.047uF	25V	F	GRM39F473Z25PT	K22145002		31-	
C 5063	CHIP CAP.	0.047uF	50V	B	GRM40B473M50PT	K22170823		1-	
C 5063	CHIP CAP.	0.047uF	25V	F	GRM39F473Z25PT	K22145002		31-	
C 5064	CHIP CAP.	0.047uF	50V	B	GRM40B473M50PT	K22170823		1-	
C 5064	CHIP CAP.	0.047uF	25V	F	GRM39F473Z25PT	K22145002		31-	
C 5067	CHIP CAP.	0.01uF	50V	B	GRM40B103M50PT	K22170817		1-	
C 5067	CHIP CAP.	0.01uF	50V	B	GRM39B103M50PT	K22174823		31-	
C 5068	CHIP CAP.	0.022uF	50V	B	GRM40B223M50PT	K22170821		1-	
C 5068	CHIP CAP.	0.022uF	25V	B	GRM39B223K25PT	K22144807		31-	
C 5069	CHIP CAP.	0.01uF	50V	B	GRM40B103M50PT	K22170817		1-	
C 5069	CHIP CAP.	0.01uF	50V	B	GRM39B103M50PT	K22174823		31-	
C 5070	AL.ELECTRO.CAP.	10uF	50V		50V100M5X11TR5	K46170021		1-	
C 5071	CHIP CAP.	0.1uF	25V	B	GRM40B104M25PT	K22140811		1-	
C 5071	CHIP CAP.	0.1uF	25V	F	GRM39F104Z25PT	K22145001		31-	
C 5072	CHIP CAP.	0.1uF	25V	B	GRM40B104M25PT	K22140811		1-	
C 5072	CHIP CAP.	0.1uF	25V	F	GRM39F104Z25PT	K22145001		31-	
C 5073	CHIP CAP.	0.047uF	50V	B	GRM40B473M50PT	K22170823		1-	
C 5073	CHIP CAP.	0.047uF	25V	F	GRM39F473Z25PT	K22145002		31-	
C 5074	CHIP CAP.	0.047uF	50V	B	GRM40B473M50PT	K22170823		1-	

CNTL-1 Unit

Parts List

REF.	DESCRIPTION	VALUE	V/W	TOL.	MFR'S DESIG	YAESU P/N	VERS.	LOT.	LAYADR
C 5074	CHIP CAP.	0.047uF	25V	F	GRM39F473Z25PT	K22145002		31-	
C 5075	AL.ELECTRO.CAP.	4.7uF	50V		50V4R7M5X11TR5	K46170020		1-	
C 5076	AL.ELECTRO.CAP.	4.7uF	50V		50V4R7M5X11TR5	K46170020		1-	
C 5077	CHIP CAP.	0.01uF	50V	B	GRM40B103M50PT	K22170817		1-	
C 5077	CHIP CAP.	0.01uF	50V	B	GRM39B103M50PT	K22174823		31-	
C 5078	CHIP CAP.	0.01uF	50V	B	GRM40B103M50PT	K22170817		1-	
C 5078	CHIP CAP.	0.01uF	50V	B	GRM39B103M50PT	K22174823		31-	
C 5079	CHIP CAP.	0.047uF	50V	B	GRM40B473M50PT	K22170823		1-	
C 5079	CHIP CAP.	0.047uF	25V	F	GRM39F473Z25PT	K22145002		31-	
C 5080	CHIP CAP.	0.047uF	50V	B	GRM40B473M50PT	K22170823		1-	
C 5080	CHIP CAP.	0.047uF	25V	F	GRM39F473Z25PT	K22145002		31-	
C 5081	CHIP CAP.	0.001uF	50V	B	GRM40B102M50PT	K22170805		1-	
C 5081	CHIP CAP.	0.001uF	50V	B	GRM39B102K50PT	K22174821		31-	
C 5082	CHIP CAP.	0.001uF	50V	B	GRM40B102M50PT	K22170805		1-	
C 5082	CHIP CAP.	0.001uF	50V	B	GRM39B102K50PT	K22174821		31-	
C 5083	CHIP CAP.	0.047uF	50V	B	GRM40B473M50PT	K22170823		1-	
C 5083	CHIP CAP.	0.047uF	25V	F	GRM39F473Z25PT	K22145002		31-	
C 5084	AL.ELECTRO.CAP.	22uF	16V		16V220M5X7TR2	K46120005		1-	
C 5106	CHIP CAP.	0.001uF	50V	B	GRM40B102M50PT	K22170805		1-	
C 5106	CHIP CAP.	0.001uF	50V	B	GRM39B102K50PT	K22174821		31-	
CO5001	CERAMIC OSC	25MHz			CSA25.00MXZ040	H7901040		1-	
CO5002	CERAMIC OSC				CSA8.00MT	H7900580		1-	
D 5001	DIODE				1SS270TJ	G2060004		1-	F1
D 5001	DIODE				1SS133 T-77	G2060001		27-	F1
D 5002	DIODE				1SS270TJ	G2060004		1-	D1
D 5002	DIODE				1SS133 T-77	G2060001		27-	D1
D 5003	DIODE				1SS270TJ	G2060004		1-	G1
D 5003	DIODE				1SS133 T-77	G2060001		27-	G1
D 5004	DIODE				1SS270TJ	G2060004		1-	G1
D 5004	DIODE				1SS133 T-77	G2060001		27-	G1
D 5005	DIODE				1SS270TJ	G2060004		1-	B1
D 5005	DIODE				1SS133 T-77	G2060001		27-	B1
D 5006	DIODE				1SS355 TE-17	G2070470		1-	E2
D 5007	DIODE				DAN202K T146	G2070182		1-	F3
D 5008	DIODE				DAN202K T146	G2070182		1-	C2
D 5009	DIODE				DAN202K T146	G2070182		1-	E1
D 5010	DIODE				1SS270TJ	G2060004		1-	B1
D 5010	DIODE				1SS133 T-77	G2060001		27-	B1
D 5011	DIODE				RD4.7EB2-T1	G2060006		1-	E1
D 5012	DIODE				1SS270TJ	G2060004		1-	G2
D 5012	DIODE				1SS133 T-77	G2060001		27-	G2
D 5013	DIODE				DAN202K T146	G2070182		1-	B3
D 5014	DIODE				1SS270TJ	G2060004		1-	B1
D 5014	DIODE				1SS133 T-77	G2060001		27-	B1
D 5015	DIODE				1SS270TJ	G2060004		1-	B1
D 5015	DIODE				1SS133 T-77	G2060001		27-	B1
D 5016	DIODE				DAN202K T146	G2070182		1-	E2
D 5018	DIODE				11EQS04-TA1B2	G2060008		1-	G3
J 5001	CONNECTOR				SC25-03WS	P0090622		1-	
J 5002	CONNECTOR				SC25-06WS	P0090625		1-	
J 5003	CONNECTOR				16FMZ-BT	P1090902		1-	
J 5004	CONNECTOR				16FMZ-BT	P1090902		1-	
J 5006	CONNECTOR				SG8035#01	P1090350		1-	
J 5007	CONNECTOR				JEY-9P-1A3F	P0091067		1-	
J 5008	CONNECTOR				20FMZ-BT	P1090903		1-	
J 5009	CONNECTOR				12FMZ-BT	P1090901		1-	
J 5010	CONNECTOR				20FMZ-BT	P1090903		1-	
J 5011	CONNECTOR				SC25-02WS	P0090621		1-	
J 5013	CONNECTOR				SC25-08WS	P0090627		1-	
J 5014	CONNECTOR				16FMZ-BT	P1090902		1-	
J 5015	CONNECTOR				12FMZ-BT	P1090901		1-	
J 5016	CONNECTOR				12FMZ-BT	P1090901		1-	
J 5017	CONNECTOR				12FMZ-BT	P1090901		1-	
J 5018	CONNECTOR				12FMZ-BT	P1090901		1-	
J 5019	CONNECTOR				20FMZ-BT	P1090903		1-	
J 5020	CONNECTOR				SC25-06WS	P0090625		1-	
J 5021	CONNECTOR				SC25-06WS	P0090625		1-	
J 5026	CONNECTOR				12FMZ-BT	P1090901		1-	

CNTL-1 Unit

Parts List

REF.	DESCRIPTION	VALUE	V/W	TOL.	MFR'S DESIG	YAESU P/N	VERS.	LOT.	LAY ADR
J 5027	CONNECTOR				HLJ2305-01-3060-01	P1090823		1-	
J 5030	CONNECTOR				12FMZ-BT	P1090901		1-	
J 5031	CONNECTOR				SC25-06WS	P0090625		1-	
J 5032	CONNECTOR				16FMZ-BT	P1090902		1-	
J 5040	CONNECTOR				SC25-03WS	P0090622		1-	
JP5001	WIRE ASSY				GRN 85 2/2	T50508500		1-	
JP5002	WIRE ASSY				GRN 55 2/2	T50505500		1-	
JP5003	WIRE ASSY				GRN 65 2/2	T50506500		1-	
JP5004	WIRE ASSY				GRN 60 2/2	T50506000		1-	
JP5005	WIRE ASSY				GRN 50 2/2	T50505000		1-	
JP5006	WIRE ASSY				GRN 125 2/2	T50512500		1-	
L 5001	M.RFC	220uH			LAP02TA221K	L1790074		1-	
L 5002	M.RFC	1mH			LAL04NA102K	L1190090		1-	
L 5003	M.RFC	5.6uH			LAP02TA5R6K	L1790055		1-	
Q 5001	TRANSISTOR				2SA1179M6-TA	G3111797F		1-	F1
Q 5002	IC				NJM78L05UA TE1	G1091325		1-	G3
Q 5003	TRANSISTOR				2SC4047-TA	G3340477		1-	B1
Q 5003	TRANSISTOR				UN2214-(TX)	G3070206		8-	B1
Q 5004	TRANSISTOR				2SC2812L6-TA	G3328127F		1-	F1
Q 5004	TRANSISTOR				2SC2812NL6-TB	G3328128F		8-	F1
Q 5005	IC				M51945BFP-600C	G1091990		1-	F1
Q 5006	IC				ADM232LJR-REEL	G1092742		1-	G2
Q 5006	IC				MAX232CWE-T	G1091907		5-	B1
Q 5007	TRANSISTOR				2SA1563-TB	G3115638		1-	B1
Q 5008	IC				M37702M8B-307FP R0410	G1093350		1-	D1
Q 5009	IC				MC14053BFR1	G1091524		1-	E1
Q 5010	IC				MC14053BFR1	G1091524		1-	E2
Q 5011	IC				M5218AFP-600C	G1091607		1-	B2
Q 5011	IC				NJM4558M(Te1)	G1093334		5-	B2
Q 5012	TRANSISTOR				2SA1563-TB	G3115638		1-	B1
Q 5013	IC				TC74HC08AF TP2	G1090975		1-	E1
Q 5014	IC				TD62783F TP1	G1091620		1-	E2
Q 5015	TRANSISTOR				2SA1563-TB	G3115638		1-	B1
Q 5016	TRANSISTOR				2SA1563-TB	G3115638		1-	B1
Q 5017	IC				TC4094BF TP2	G1091346		1-	B1
Q 5018	IC				TC74HC08AF TP2	G1090975		1-	E2
Q 5019	TRANSISTOR				2SC4047-TA	G3340477		1-	G1
Q 5019	TRANSISTOR				UN2214-(TX)	G3070206		8-	G1
Q 5020	IC				UPD74HC238GS-T1	G1093285		1-	F1
Q 5021	IC				UPD74HC238GS-T1	G1093285		1-	F2
Q 5022	TRANSISTOR				2SC4047-TA	G3340477		1-	D1
Q 5022	TRANSISTOR				UN2214-(TX)	G3070206		8-	D1
Q 5023	IC				M5M82C55AFP-2D7	G1090993		1-	G2
Q 5024	IC				M24C16-WMN6T	G1092980		1-	D1
Q 5025	IC				TD62783F TP1	G1091620		1-	C2
Q 5026	IC				FQ7927	G1091854		1-	C1
Q 5027	IC				FQ7927	G1091854		1-	C1
Q 5028	IC				M5M82C55AFP-2D7	G1090993		1-	E2
Q 5029	IC				M5M82C55AFP-2D7	G1090993		1-	F2
Q 5030	IC				M5M82C55AFP-2D7	G1090993		1-	D2
Q 5031	IC				UPD4013BG-T2	G1091027		1-	G2
Q 5032	TRANSISTOR				2SC4047-TA	G3340477		1-	B3
Q 5032	TRANSISTOR				UN2214-(TX)	G3070206		8-	B3
Q 5033	TRANSISTOR				2SC4047-TA	G3340477		1-	G2
Q 5033	TRANSISTOR				UN2214-(TX)	G3070206		8-	G2
Q 5034	TRANSISTOR				2SA1563-TB	G3115638		1-	B3
Q 5035	IC				MB89133APFM-G-258-BND	G1092046		1-	G1
Q 5036	TRANSISTOR				2SC4047-TA	G3340477		1-	B3
Q 5036	TRANSISTOR				UN2214-(TX)	G3070206		8-	B3
Q 5037	IC				TC74HC32AF TP2	G1091061		1-	F1
Q 5038	IC				MC14053BFR1	G1091524		1-	F2
Q 5039	IC				TC74HC04AF TP2	G1091228		1-	F2
Q 5040	IC				24LC02BTI/SN	G1092237		1-	G1
Q 5041	TRANSISTOR				2SC4047-TA	G3340477		1-	G1
Q 5041	TRANSISTOR				UN2214-(TX)	G3070206		8-	G1
Q 5042	TRANSISTOR				2SC4047-TA	G3340477		1-	G1
Q 5042	TRANSISTOR				UN2214-(TX)	G3070206		8-	G1
Q 5043	IC				M5218AFP-600C	G1091607		1-	C3

CNTL-1 Unit

Parts List

REF.	DESCRIPTION	VALUE	V/W	TOL.	MFR'S DESIG	YAESU P/N	VERS.	LOT.	LAY ADR
Q 5043	IC				NJM4558M(TE1)	G1093334		5-	C3
Q 5044	TRANSISTOR				2SC4047-TA	G3340477		1-	C3
Q 5044	TRANSISTOR				UN2214-(TX)	G3070206		8-	C3
Q 5045	TRANSISTOR				2SC4047-TA	G3340477		1-	C2
Q 5045	TRANSISTOR				UN2214-(TX)	G3070206		8-	C2
Q 5046	TRANSISTOR				2SC4047-TA	G3340477		1-	F3
Q 5046	TRANSISTOR				UN2214-(TX)	G3070206		8-	F3
Q 5047	TRANSISTOR				2SC4047-TA	G3340477		1-	B2
Q 5047	TRANSISTOR				UN2214-(TX)	G3070206		8-	B2
Q 5048	TRANSISTOR				2SC4047-TA	G3340477		1-	B3
Q 5048	TRANSISTOR				UN2214-(TX)	G3070206		8-	B3
Q 5049	TRANSISTOR				2SC4047-TA	G3340477		1-	B2
Q 5049	TRANSISTOR				UN2214-(TX)	G3070206		8-	B2
Q 5050	TRANSISTOR				2SC4047-TA	G3340477		1-	B2
Q 5050	TRANSISTOR				UN2214-(TX)	G3070206		8-	B2
Q 5051	TRANSISTOR				2SC4047-TA	G3340477		1-	B2
Q 5051	TRANSISTOR				UN2214-(TX)	G3070206		8-	B2
Q 5052	TRANSISTOR				2SC4047-TA	G3340477		1-	B2
Q 5052	TRANSISTOR				UN2214-(TX)	G3070206		8-	B2
Q 5053	TRANSISTOR				2SC4047-TA	G3340477		1-	B2
Q 5053	TRANSISTOR				UN2214-(TX)	G3070206		8-	B2
Q 5055	IC				M5218AFP-600C	G1091607		1-	G2
Q 5055	IC				NJM4558M(TE1)	G1093334		5-	G2
Q 5056	IC				NJM78L05UA TE1	G1091325		1-	A2
Q 5058	TRANSISTOR				2SC4047-TA	G3340477		1-	F1
Q 5058	TRANSISTOR				UN2214-(TX)	G3070206		8-	F1
Q 5059	TRANSISTOR				2SC4047-TA	G3340477		1-	D3
Q 5059	TRANSISTOR				UN2214-(TX)	G3070206		8-	D3
Q 5060	TRANSISTOR				2SA1563-TB	G3115638		1-	A2
Q 5061	TRANSISTOR				2SC4047-TA	G3340477		1-	A2
Q 5061	TRANSISTOR				UN2214-(TX)	G3070206		8-	A2
R 5001	CHIP RES.	4.7k	1/10W	0.50%	RR1220P-472-D-T5	J24209187		1-	
R 5002	CHIP RES.	4.7k	1/10W	5%	RMC1/10T 472J	J24205472		1-	
R 5003	CHIP RES.	10k	1/10W	5%	RMC1/10T 103J	J24205103		1-	
R 5004	CHIP RES.	6.8k	1/10W	5%	RMC1/10T 682J	J24205682		1-	
R 5005	CHIP RES.	47k	1/10W	5%	RMC1/10T 473J	J24205473		1-	
R 5006	CHIP RES.	1k	1/10W	5%	RMC1/10T 102J	J24205102		1-	
R 5007	CHIP RES.	10	1/10W	5%	RMC1/10T 100J	J24205100		1-	
R 5008	CHIP RES.	10k	1/10W	5%	RMC1/10T 103J	J24205103		1-	
R 5009	CHIP RES.	10k	1/10W	5%	RMC1/10T 103J	J24205103		1-	
R 5010	CHIP RES.	1k	1/10W	5%	RMC1/10T 102J	J24205102		1-	
R 5011	CHIP RES.	1k	1/10W	5%	RMC1/10T 102J	J24205102		1-	
R 5012	CHIP RES.	10k	1/10W	5%	RMC1/10T 103J	J24205103		1-	
R 5013	CHIP RES.	0	1/10W	5%	RMC1/10T 000J	J24205000		1-	
R 5014	CHIP RES.	10k	1/10W	5%	RMC1/10T 103J	J24205103		1-	
R 5015	CHIP RES.	18k	1/10W	5%	RMC1/10T 183J	J24205183		1-	
R 5016	CHIP RES.	39k	1/10W	5%	RMC1/10T 393J	J24205393		1-	
R 5017	CHIP RES.	82k	1/10W	5%	RMC1/10T 823J	J24205823		1-	
R 5018	CHIP RES.	470k	1/10W	5%	RMC1/10T 474J	J24205474		1-	
R 5020	CHIP RES.	100k	1/10W	5%	RMC1/10T 104J	J24205104		1-	
R 5021	CHIP RES.	10k	1/10W	5%	RMC1/10T 103J	J24205103		1-	
R 5022	CHIP RES.	18k	1/10W	5%	RMC1/10T 183J	J24205183		1-	
R 5023	CHIP RES.	39k	1/10W	5%	RMC1/10T 393J	J24205393		1-	
R 5024	CHIP RES.	82k	1/10W	5%	RMC1/10T 823J	J24205823		1-	
R 5025	CHIP RES.	47k	1/10W	5%	RMC1/10T 473J	J24205473		1-	
R 5026	CHIP RES.	1M	1/10W	5%	RMC1/10T 105J	J24205105		1-	
R 5027	CHIP RES.	1k	1/10W	5%	RMC1/10T 102J	J24205102		1-	
R 5028	CHIP RES.	100	1/10W	5%	RMC1/10T 101J	J24205101		1-	
R 5029	CHIP RES.	100	1/10W	5%	RMC1/10T 101J	J24205101		1-	
R 5030	CHIP RES.	100	1/10W	5%	RMC1/10T 101J	J24205101		1-	
R 5031	CHIP RES.	1k	1/10W	5%	RMC1/10T 102J	J24205102		1-	
R 5032	CHIP RES.	1k	1/10W	5%	RMC1/10T 102J	J24205102		1-	
R 5033	CHIP RES.	10k	1/10W	5%	RMC1/10T 103J	J24205103		1-	
R 5034	CHIP RES.	27k	1/10W	5%	RMC1/10T 273J	J24205273		1-	
R 5035	CHIP RES.	10k	1/10W	5%	RMC1/10T 103J	J24205103		1-	
R 5036	CHIP RES.	10k	1/10W	5%	RMC1/10T 103J	J24205103		1-	
R 5037	CHIP RES.	47k	1/10W	5%	RMC1/10T 473J	J24205473		1-	
R 5038	CHIP RES.	47k	1/10W	5%	RMC1/10T 473J	J24205473		1-	

CNTL-1 Unit

Parts List

REF.	DESCRIPTION	VALUE	V/W	TOL.	MFR'S DESIG	YAESU P/N	VERS.	LOT.	LAY ADR
R 5039	CHIP RES.	47k	1/10W	5%	RMC1/10T 473J	J24205473		1-	
R 5040	CHIP RES.	47k	1/10W	5%	RMC1/10T 473J	J24205473		1-	
R 5041	CHIP RES.	4.7k	1/10W	5%	RMC1/10T 472J	J24205472		1-	
R 5042	CHIP RES.	10k	1/10W	5%	RMC1/10T 103J	J24205103		1-	
R 5043	CHIP RES.	10k	1/10W	5%	RMC1/10T 103J	J24205103		1-	
R 5044	CHIP RES.	10k	1/10W	5%	RMC1/10T 103J	J24205103		1-	
R 5047	CHIP RES.	47k	1/10W	5%	RMC1/10T 473J	J24205473		1-	
R 5048	CHIP RES.	47k	1/10W	5%	RMC1/10T 473J	J24205473		1-	
R 5049	CHIP RES.	47k	1/10W	5%	RMC1/10T 473J	J24205473		1-	
R 5050	CHIP RES.	47k	1/10W	5%	RMC1/10T 473J	J24205473		1-	
R 5051	CHIP RES.	100k	1/10W	5%	RMC1/10T 104J	J24205104		1-	
R 5052	CHIP RES.	100k	1/10W	5%	RMC1/10T 104J	J24205104		1-	
R 5053	CHIP RES.	100k	1/10W	5%	RMC1/10T 104J	J24205104		1-	
R 5054	CHIP RES.	47k	1/10W	5%	RMC1/10T 473J	J24205473		1-	
R 5055	CHIP RES.	100k	1/10W	5%	RMC1/10T 104J	J24205104		1-	
R 5056	CHIP RES.	10k	1/10W	5%	RMC1/10T 103J	J24205103		1-	
R 5057	CHIP RES.	47k	1/10W	5%	RMC1/10T 473J	J24205473		1-	
R 5058	CHIP RES.	47k	1/10W	5%	RMC1/10T 473J	J24205473		1-	
R 5059	CHIP RES.	47k	1/10W	5%	RMC1/10T 473J	J24205473		1-	
R 5060	CHIP RES.	47k	1/10W	5%	RMC1/10T 473J	J24205473		1-	
R 5061	CHIP RES.	27k	1/10W	5%	RMC1/10T 273J	J24205273		1-	
R 5062	CHIP RES.	27k	1/10W	5%	RMC1/10T 273J	J24205273		1-	
R 5063	CHIP RES.	10k	1/10W	5%	RMC1/10T 103J	J24205103		1-	
R 5064	CHIP RES.	0	1/10W	5%	RMC1/10T 000J	J24205000		1-	
R 5065	CHIP RES.	100k	1/10W	5%	RMC1/10T 104J	J24205104		1-	
R 5066	CHIP RES.	22k	1/10W	5%	RMC1/10T 223J	J24205223		1-	
R 5066	CHIP RES.	18k	1/10W	5%	RMC1/10T 183J	J24205183		29-	
R 5067	CHIP RES.	3.3k	1/10W	5%	RMC1/10T 332J	J24205332		1-	
R 5068	CHIP RES.	100k	1/10W	5%	RMC1/10T 104J	J24205104		1-	
R 5069	CHIP RES.	100k	1/10W	5%	RMC1/10T 104J	J24205104		1-	
R 5070	CHIP RES.	47k	1/10W	5%	RMC1/10T 473J	J24205473		1-	
R 5071	CHIP RES.	10k	1/10W	5%	RMC1/10T 103J	J24205103		1-	
R 5072	CHIP RES.	10k	1/10W	5%	RMC1/10T 103J	J24205103		1-	
R 5073	CHIP RES.	10k	1/10W	5%	RMC1/10T 103J	J24205103		1-	
R 5074	CHIP RES.	10k	1/10W	5%	RMC1/10T 103J	J24205103		1-	
R 5075	CHIP RES.	10k	1/10W	5%	RMC1/10T 103J	J24205103		1-	
R 5076	CHIP RES.	1k	1/10W	5%	RMC1/10T 102J	J24205102		1-	
R 5077	CHIP RES.	1k	1/10W	5%	RMC1/10T 102J	J24205102		1-	
R 5078	CHIP RES.	100k	1/10W	5%	RMC1/10T 104J	J24205104		1-	
R 5079	CHIP RES.	10k	1/10W	5%	RMC1/10T 103J	J24205103		1-	
R 5080	CHIP RES.	22k	1/10W	5%	RMC1/10T 223J	J24205223		1-	
R 5081	CHIP RES.	10k	1/10W	5%	RMC1/10T 103J	J24205103		1-	
R 5082	CHIP RES.	22k	1/10W	5%	RMC1/10T 223J	J24205223		1-	
R 5083	CHIP RES.	470	1/10W	5%	RMC1/10T 471J	J24205471		1-	
R 5084	CHIP RES.	100k	1/10W	5%	RMC1/10T 104J	J24205104		1-	
R 5085	CHIP RES.	100k	1/10W	5%	RMC1/10T 104J	J24205104		1-	
R 5086	CHIP RES.	100k	1/10W	5%	RMC1/10T 104J	J24205104		1-	
R 5087	CHIP RES.	100k	1/10W	5%	RMC1/10T 104J	J24205104		1-	
R 5088	CHIP RES.	100k	1/10W	5%	RMC1/10T 104J	J24205104		1-	
R 5089	CHIP RES.	100k	1/10W	5%	RMC1/10T 104J	J24205104		1-	
R 5090	CHIP RES.	100k	1/10W	5%	RMC1/10T 104J	J24205104		1-	
R 5091	CHIP RES.	100k	1/10W	5%	RMC1/10T 104J	J24205104		1-	
R 5092	CHIP RES.	100k	1/10W	5%	RMC1/10T 104J	J24205104		1-	
R 5093	CHIP RES.	100k	1/10W	5%	RMC1/10T 104J	J24205104		1-	
R 5094	CHIP RES.	100k	1/10W	5%	RMC1/10T 104J	J24205104		1-	
R 5095	CHIP RES.	100k	1/10W	5%	RMC1/10T 104J	J24205104		1-	
R 5096	CHIP RES.	100k	1/10W	5%	RMC1/10T 104J	J24205104		1-	
R 5097	CHIP RES.	100k	1/10W	5%	RMC1/10T 104J	J24205104		1-	
R 5098	CHIP RES.	100k	1/10W	5%	RMC1/10T 104J	J24205104		1-	
R 5099	CHIP RES.	100k	1/10W	5%	RMC1/10T 104J	J24205104		1-	
R 5100	CHIP RES.	100k	1/10W	5%	RMC1/10T 104J	J24205104		1-	
R 5101	CHIP RES.	100k	1/10W	5%	RMC1/10T 104J	J24205104		1-	
R 5102	CHIP RES.	1M	1/10W	5%	RMC1/10T 105J	J24205105		1-	
R 5103	CHIP RES.	1M	1/10W	5%	RMC1/10T 105J	J24205105		1-	
R 5104	CHIP RES.	1M	1/10W	5%	RMC1/10T 105J	J24205105		1-	
R 5105	CHIP RES.	1M	1/10W	5%	RMC1/10T 105J	J24205105		1-	
R 5106	CHIP RES.	1M	1/10W	5%	RMC1/10T 105J	J24205105		1-	
R 5107	CHIP RES.	1M	1/10W	5%	RMC1/10T 105J	J24205105		1-	

CNTL-1 Unit

Parts List

REF.	DESCRIPTION	VALUE	V/W	TOL.	MFR'S DESIG	YAESU P/N	VERS.	LOT.	LAY ADR
R 5108	CHIP RES.	1M	1/10W	5%	RMC1/10T 105J	J24205105		1-	
R 5109	CHIP RES.	1M	1/10W	5%	RMC1/10T 105J	J24205105		1-	
R 5120	CHIP RES.	47k	1/10W	5%	RMC1/10T 473J	J24205473		1-	
R 5121	CHIP RES.	100k	1/10W	5%	RMC1/10T 104J	J24205104		1-	
R 5122	CHIP RES.	27k	1/10W	5%	RMC1/10T 273J	J24205273		1-	
R 5123	CHIP RES.	10k	1/10W	5%	RMC1/10T 103J	J24205103		1-	
R 5124	CHIP RES.	27k	1/10W	5%	RMC1/10T 273J	J24205273		1-	
R 5125	CHIP RES.	10k	1/10W	5%	RMC1/10T 103J	J24205103		1-	
R 5126	CHIP RES.	10k	1/10W	5%	RMC1/10T 103J	J24205103		1-	
R 5127	CHIP RES.	68k	1/10W	5%	RMC1/10T 683J	J24205683		1-	
R 5128	CHIP RES.	1k	1/10W	5%	RMC1/10T 102J	J24205102		1-	
R 5129	CHIP RES.	1k	1/10W	5%	RMC1/10T 102J	J24205102		1-	
R 5130	CHIP RES.	27k	1/10W	5%	RMC1/10T 273J	J24205273		1-	
R 5131	CHIP RES.	22	1/4W	5%	RMC1/4 220JATP	J24245220		1-	
R 5132	CHIP RES.	10k	1/10W	5%	RMC1/10T 103J	J24205103		1-	
R 5133	CHIP RES.	10k	1/10W	5%	RMC1/10T 103J	J24205103		1-	
R 5134	CHIP RES.	100	1/4W	5%	RMC1/4 101JATP	J24245101		1-	
R 5135	CHIP RES.	1k	1/10W	5%	RMC1/10T 102J	J24205102		1-	
R 5136	CHIP RES.	3.3k	1/10W	5%	RMC1/10T 332J	J24205332		1-	
R 5137	CHIP RES.	100k	1/10W	5%	RMC1/10T 104J	J24205104		1-	
R 5138	CHIP RES.	100k	1/10W	5%	RMC1/10T 104J	J24205104		1-	
R 5139	CARBON FILM RES.	10k	1/6W	5%	RD16TPJ103 10K	J07225103		1-	
R 5139	CHIP RES.	10k	1/10W	5%	RMC1/10T 103J	J24205103		31-	
R 5157	CHIP RES.	10k	1/10W	5%	RMC1/10T 103J	J24205103		1-	
R 5158	CHIP RES.	100k	1/10W	5%	RMC1/10T 104J	J24205104		1-	
R 5159	CHIP RES.	220	1/10W	5%	RMC1/10T 221J	J24205221		1-	
R 5160	CHIP RES.	1k	1/10W	5%	RMC1/10T 102J	J24205102		1-	
S 5001	SLIDE SWITCH				SSSS912N-2A-OR	N6090094		1-	
VR5001	POT.	10k			EVN-DCAA03B14 10K	J50784103		1-	
VR5002	POT.	10k			RH063MC14R 10KB	J51794103		1-	
	LEAF SPRING					R0152180	W/ CE LABEL	10-	

CNTL-1 Unit

Note

DISPLAY Unit

Circuit Diagram

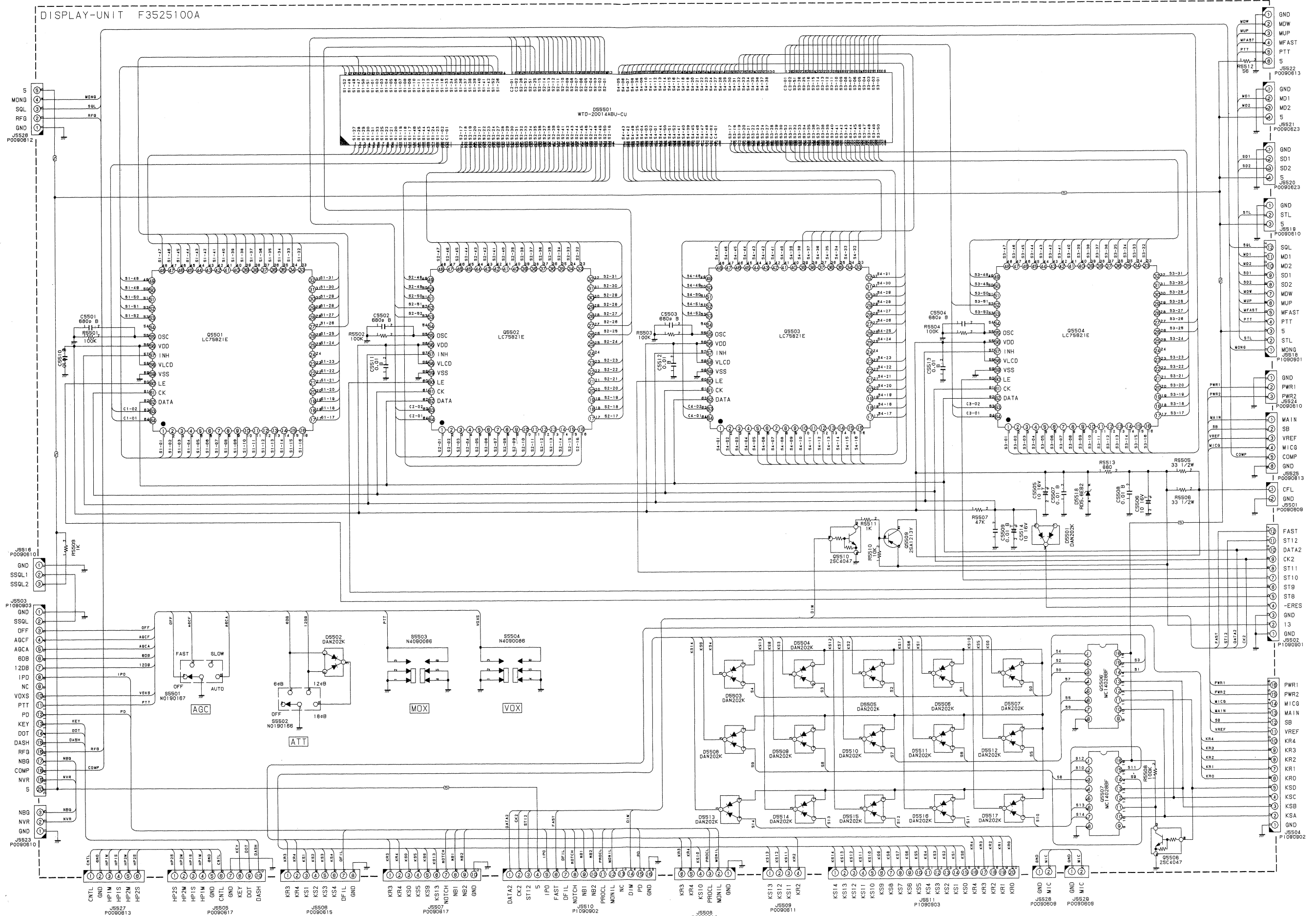

DISPLAY Unit

Parts Layout

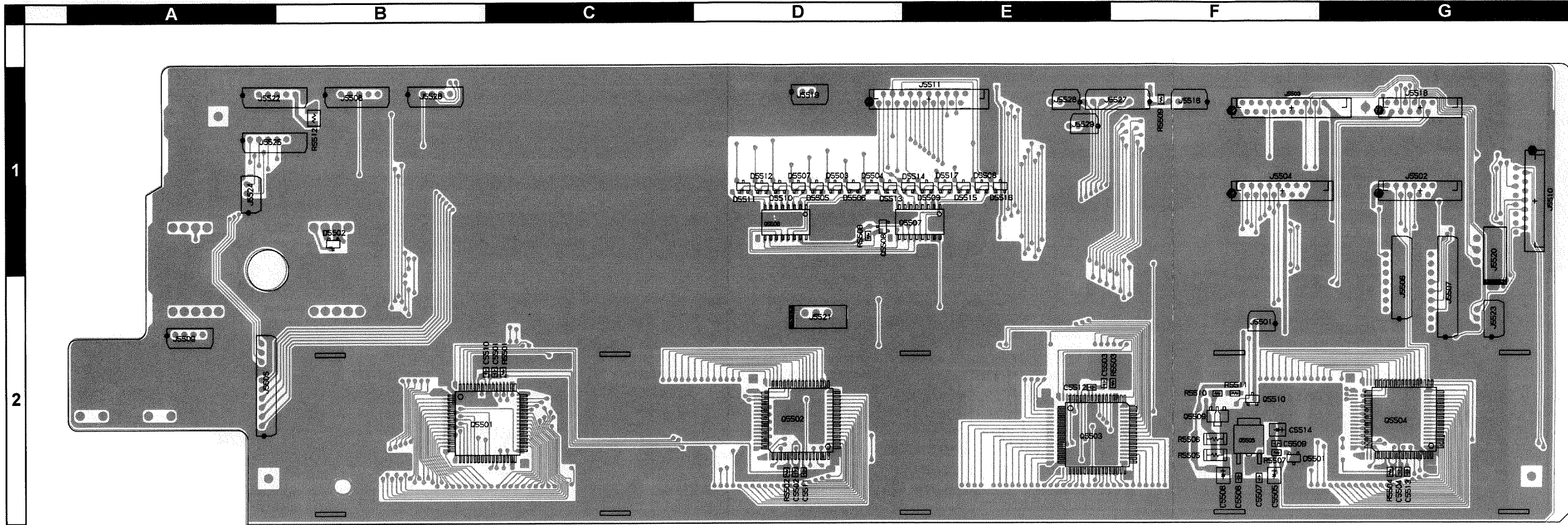

Side A

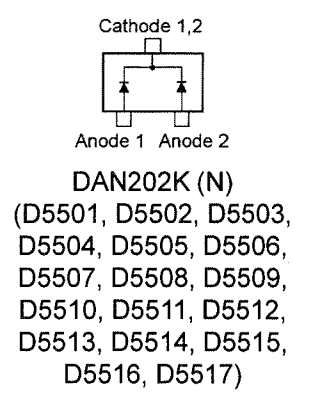
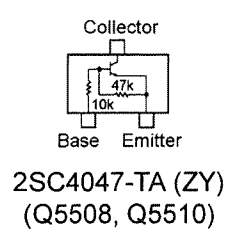
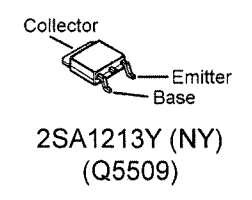
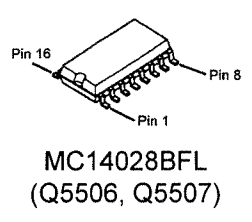
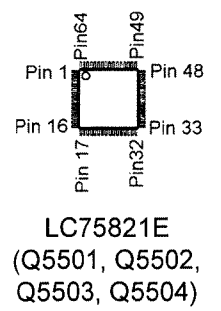

DISPLAY Unit

Parts Layout

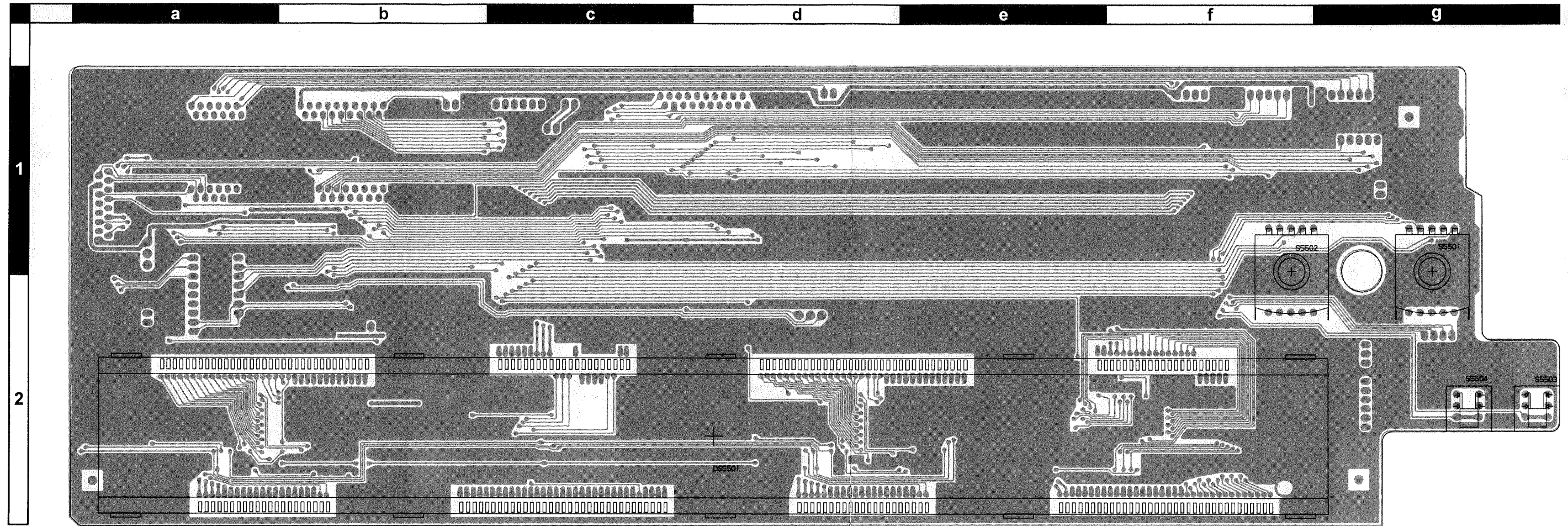

Side B

REF.	DESCRIPTION	VALUE	V/W	TOL.	MFR'S DESIG	YAESU P/N	VERS.	LOT.	LAY ADR
PCB with Components						CB1197001	W/CE LABEL		
PCB with Components						CB1197002	W/CE LABEL		
Printed Circuit Board						F3525101A		1-	
C 5501	CHIPCAP.	680pF	50V	B	GRM40B681M50PT	K22170803		1-	
C 5502	CHIPCAP.	680pF	50V	B	GRM40B681M50PT	K22170803		1-	
C 5503	CHIPCAP.	680pF	50V	B	GRM40B681M50PT	K22170803		1-	
C 5504	CHIPCAP.	680pF	50V	B	GRM40B681M50PT	K22170803		1-	
C 5505	CHIP TA.CAP.	10uF	16V		TEMSVB21C106M-8R	K78120025		1-	
C 5506	CHIP TA.CAP.	10uF	16V		TEMSVB21C106M-8R	K78120025		1-	
C 5507	CHIPCAP.	0.01uF	50V	B	GRM40B103M50PT	K22170817		1-	
C 5508	CHIPCAP.	0.01uF	50V	B	GRM40B103M50PT	K22170817		1-	
C 5509	CHIPCAP.	0.01uF	50V	B	GRM40B103M50PT	K22170817		1-	
C 5510	CHIPCAP.	0.01uF	50V	B	GRM40B103M50PT	K22170817		1-	
C 5511	CHIPCAP.	0.01uF	50V	B	GRM40B103M50PT	K22170817		1-	
C 5512	CHIPCAP.	0.01uF	50V	B	GRM40B103M50PT	K22170817		1-	
C 5513	CHIPCAP.	0.01uF	50V	B	GRM40B103M50PT	K22170817		1-	
C 5514	CHIP TA.CAP.	10uF	16V		TEMSVB21C106M-8R	K78120025		1-	
C 5515	CHIPCAP.	0.001uF	50V	B	GRM40B102K50PT	K22170825	W/CE LABEL	10-	
C 5516	CHIPCAP.	0.001uF	50V	B	GRM40B102K50PT	K22170825	W/CE LABEL	10-	
C 5517	CHIPCAP.	0.001uF	50V	B	GRM40B102K50PT	K22170825	W/CE LABEL	10-	
C 5518	CHIPCAP.	0.001uF	50V	B	GRM40B102K50PT	K22170825	W/CE LABEL	10-	
C 5519	CHIPCAP.	0.001uF	50V	B	GRM40B102K50PT	K22170825	W/CE LABEL	10-	
D 5501	DIODE				DAN202K T146	G2070182		1-	F2
D 5502	DIODE				DAN202K T146	G2070182		1-	B1
D 5503	DIODE				DAN202K T146	G2070182		1-	D1
D 5504	DIODE				DAN202K T146	G2070182		1-	D1
D 5505	DIODE				DAN202K T146	G2070182		1-	D1
D 5506	DIODE				DAN202K T146	G2070182		1-	D1
D 5507	DIODE				DAN202K T146	G2070182		1-	D1
D 5508	DIODE				DAN202K T146	G2070182		1-	E1
D 5509	DIODE				DAN202K T146	G2070182		1-	E1
D 5510	DIODE				DAN202K T146	G2070182		1-	D1
D 5511	DIODE				DAN202K T146	G2070182		1-	D1
D 5512	DIODE				DAN202K T146	G2070182		1-	D1
D 5513	DIODE				DAN202K T146	G2070182		1-	D1
D 5514	DIODE				DAN202K T146	G2070182		1-	E1
D 5515	DIODE				DAN202K T146	G2070182		1-	E1
D 5516	DIODE				DAN202K T146	G2070182		1-	E1
D 5517	DIODE				DAN202K T146	G2070182		1-	E1
D 5518	DIODE				RD5.6EB2	G2090156		1-	
DS5501	LCD				WTD-20014ABU-CU	G6090141		1-	
J 5501	CONNECTOR				SB20-02WS	P0090609		1-	
J 5502	CONNECTOR				12FMZ-BT	P1090901		1-	
J 5503	CONNECTOR				20FMZ-BT	P1090903		1-	
J 5504	CONNECTOR				16FMZ-BT	P1090902		1-	
J 5505	CONNECTOR				SB20-10WS	P0090617		1-	
J 5506	CONNECTOR				SB20-08WS	P0090615		1-	
J 5507	CONNECTOR				SB20-10WS	P0090617		1-	
J 5508	CONNECTOR				SB20-06WS	P0090613		1-	
J 5509	CONNECTOR				SB20-04WS	P0090611		1-	
J 5510	CONNECTOR				16FMZ-BT	P1090902		1-	
J 5511	CONNECTOR				20FMZ-BT	P1090903		1-	
J 5516	CONNECTOR				SB20-03WS	P0090610		1-	
J 5518	CONNECTOR				12FMZ-BT	P1090901		1-	
J 5519	CONNECTOR				SB20-03WS	P0090610		1-	
J 5520	CONNECTOR				SC25-04WS	P0090623		1-	
J 5521	CONNECTOR				SC25-04WS	P0090623		1-	
J 5522	CONNECTOR				SB20-06WS	P0090613		1-	
J 5523	CONNECTOR				SB20-03WS	P0090610		1-	
J 5524	CONNECTOR				SB20-03WS	P0090610		1-	
J 5525	CONNECTOR				SB20-06WS	P0090613		1-	
J 5526	CONNECTOR				SB20-05WS	P0090612		1-	
J 5527	CONNECTOR				SB20-06WS	P0090613		1-	
J 5528	CONNECTOR				SB20-02WS	P0090609		1-	
J 5529	CONNECTOR				SB20-02WS	P0090609		1-	
MD5501	CFLUNIT				K-CA393YAS	Q7000227		1-	
Q 5501	IC				LC75821E	G1092191		1-	B2
Q 5502	IC				LC75821E	G1092191		1-	D2

DISPLAY Unit

Parts List

REF.	DESCRIPTION	VALUE	V/W	TOL.	MFR'S DESIG	YAESU P/N	VERS.	LOT.	LAY ADR
Q 5503	C				LC75821E	G1092191		1-	E2
Q 5504	C				LC75821E	G1092191		1-	G2
Q 5506	C				MC14028BFL	G1090998		1-	D1
Q 5507	C				MC14028BFL	G1090998		1-	E1
Q 5508	TRANSISTOR				2SC4047-TA	G3340477		1-	D1
Q 5508	TRANSISTOR				UN2214-(TX)	G3070206		8-	D1
Q 5509	TRANSISTOR				2SA1213Y TE12R	G3112137Y		1-	F2
Q 5510	TRANSISTOR				2SC4047-TA	G3340477		1-	F2
Q 5510	TRANSISTOR				UN2214-(TX)	G3070206		8-	F2
R 5501	CHIPRES.	100k	1/10W	5%	RMC1/10T 104J	J24205104		1-	
R 5502	CHIPRES.	100k	1/10W	5%	RMC1/10T 104J	J24205104		1-	
R 5503	CHIPRES.	100k	1/10W	5%	RMC1/10T 104J	J24205104		1-	
R 5504	CHIPRES.	100k	1/10W	5%	RMC1/10T 104J	J24205104		1-	
R 5505	CHIPRES.	33	1/2W	5%	RMC1/2330JCTP	J24275330		1-	
R 5506	CHIPRES.	33	1/2W	5%	RMC1/2330JCTP	J24275330		1-	
R 5507	CHIPRES.	47k	1/10W	5%	RMC1/10T 473J	J24205473		1-	
R 5508	CHIPRES.	100k	1/10W	5%	RMC1/10T 104J	J24205104		1-	
R 5509	CHIPRES.	1k	1/10W	5%	RMC1/10T 102J	J24205102		1-	
R 5510	CHIPRES.	10k	1/10W	5%	RMC1/10T 103J	J24205103		1-	
R 5511	CHIPRES.	1k	1/10W	5%	RMC1/10T 102J	J24205102		1-	
R 5512	CHIPRES.	56	1/4W	5%	RMC1/4 560JATP	J24245560		1-	
R 5513	CARBON FILM RES.	680	1/6W	5%	RD16PJ681 680	J01225681		1-	
S 5501	ROTARY SWITCH				SRBV14-F15	N0190167		1-	
S 5502	ROTARY SWITCH				SRBV14-F20-1	N0190166		1-	
S 5503	PUSH SWITCH				SPH121A94	N4090086		1-	
S 5504	PUSH SWITCH				SPH121A94	N4090086		1-	
	HOLDER					R0151200		1-	
	HOLDER					R0521150		1-	
	LIGHTGUIDE					R3521160		1-	
	RUBBERCONNECTOR					R7151810		1-	
	SHEET					R8151450		1-	
	SHEET					R8151800		1-	
	LEAD CLAMP				L=38	S5000057		1-	

LPF-1 Unit Circuit Diagram

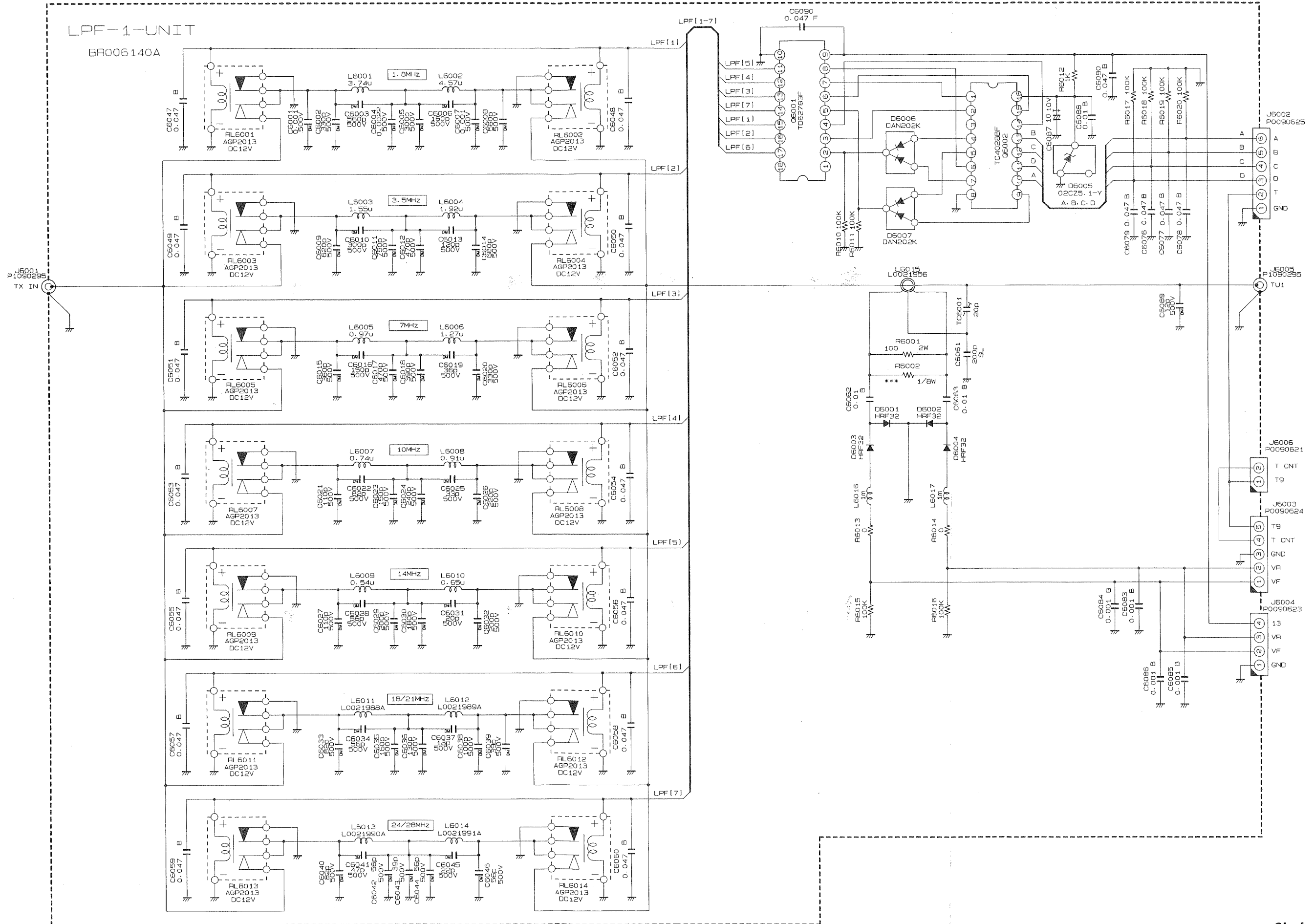

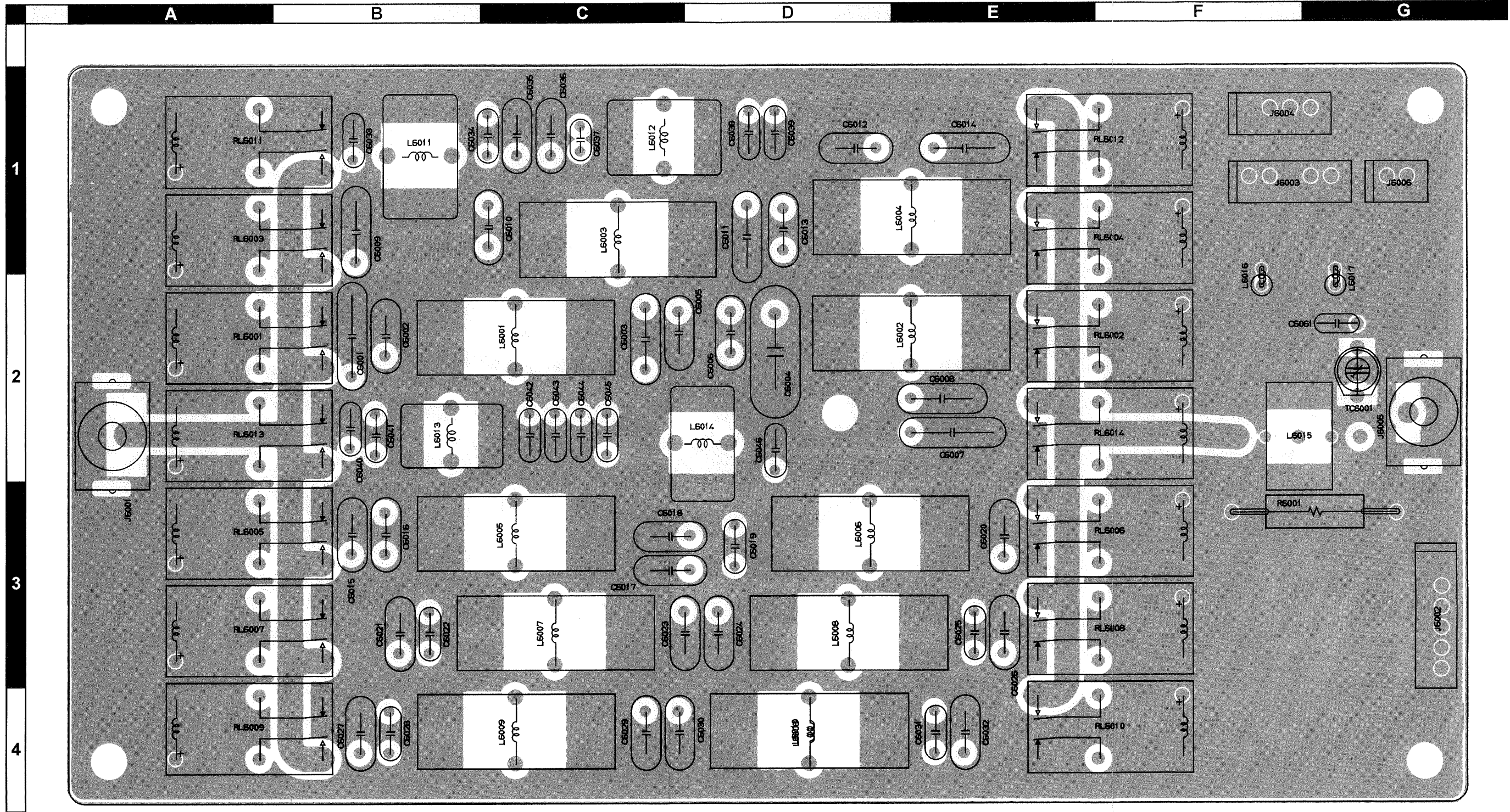

Side A

LPF-1 Unit

Parts Layout

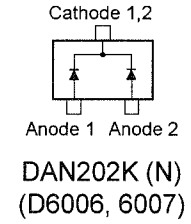
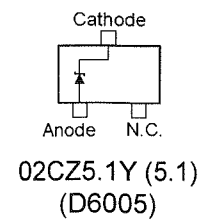
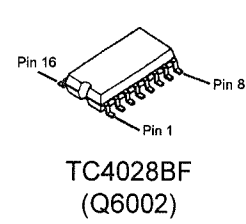
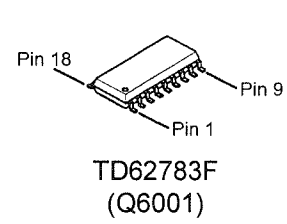
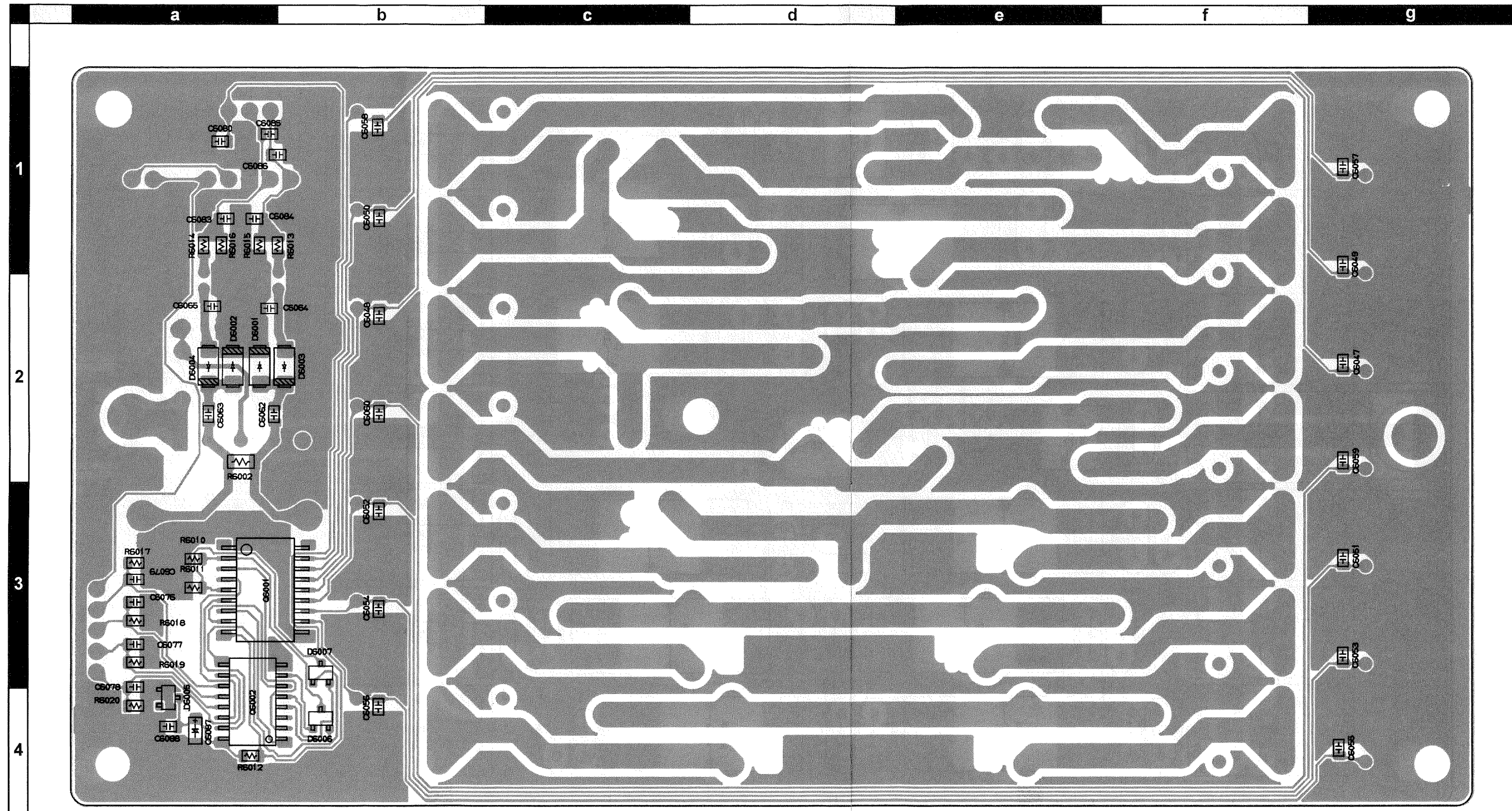

Side B

REF.	DESCRIPTION	VALUE	V/W	TOL.	MFR'S DESIG	YAESU P/N	VERS.	LOT.	LAYADR
PCB with Components						CB1361001			
Printed Circuit Board						FR006140B		1	
C 6001	MICA CAP.	0.001uF	500V		LCQ21102J5	K30275102		1-	
C 6002	MICA CAP.	330pF	500V		LCQ17331J5	K30275331		1-	
C 6003	MICA CAP.	560pF	500V		LCQ18561J5	K30275561		1-	
C 6004	MICA CAP.	0.0022uF	500V		DM19D222J5	K30279098		1-	
C 6005	MICA CAP.	300pF	500V		LCQ17301J5	K30275301		1-	
C 6006	MICA CAP.	160pF	500V		LCQ17161J5	K30275161		1-	
C 6007	MICA CAP.	0.001uF	500V		LCQ21102J5	K30275102		1-	
C 6008	MICA CAP.	560pF	500V		LCQ18561J5	K30275561		1-	
C 6009	MICA CAP.	620pF	500V		LCQ18621J5	K30275621		1-	
C 6010	MICA CAP.	300pF	500V		LCQ17301J5	K30275301		1-	
C 6011	MICA CAP.	750pF	500V		LCQ18751J5	K30275751		1-	
C 6012	MICA CAP.	470pF	500V		LCQ17471J5	K30275471		1-	
C 6013	MICA CAP.	120pF	500V		LCQ17121J5	K30275121		1-	
C 6014	MICA CAP.	680pF	500V		LCQ18681J5	K30275681		1-	
C 6015	MICA CAP.	360pF	500V		LCQ17361J5	K30275361		1-	
C 6016	MICA CAP.	150pF	500V		LCQ17151J5	K30275151		1-	
C 6017	MICA CAP.	470pF	500V		LCQ17471J5	K30275471		1-	
C 6018	MICA CAP.	390pF	500V		LCQ17391J5	K30275391		1-	
C 6019	MICA CAP.	36pF	500V		LCQ12360J5	K30275360		1-	
C 6020	MICA CAP.	330pF	500V		LCQ17331J5	K30275331		1-	
C 6021	MICA CAP.	110pF	500V		LCQ17111J5	K30275111		1-	
C 6022	MICA CAP.	82pF	500V		LCQ12820J5	K30275820		1-	
C 6023	MICA CAP.	150pF	500V		LCQ17151J5	K30275151		1-	
C 6024	MICA CAP.	240pF	500V		LCQ17241J5	K30275241		1-	
C 6025	MICA CAP.	33pF	500V		LCQ12330J5	K30275330		1-	
C 6026	MICA CAP.	220pF	500V		LCQ17221J5	K30275221		1-	
C 6027	MICA CAP.	110pF	500V		LCQ17111J5	K30275111		1-	
C 6028	MICA CAP.	56pF	500V		LCQ12560J5	K30275560		1-	
C 6029	MICA CAP.	200pF	500V		LCQ17201J5	K30275201		1-	
C 6030	MICA CAP.	180pF	500V		LCQ17181J5	K30275181		1-	
C 6031	MICA CAP.	20pF	500V		LCQ12200J5	K30275200		1-	
C 6032	MICA CAP.	200pF	500V		LCQ17201J5	K30275201		1-	
C 6033	MICA CAP.	82pF	500V		LCQ12820J5	K30275820		1-	
C 6034	MICA CAP.	56pF	500V		LCQ12560J5	K30275560		1-	
C 6035	MICA CAP.	160pF	500V		LCQ17161J5	K30275161		1-	
C 6036	MICA CAP.	130pF	500V		LCQ17131J5	K30275131		1-	
C 6037	MICA CAP.	18pF	500V		LCQ11180J5	K30275180		1-	
C 6038	MICA CAP.	100pF	500V		LCQ12101J5	K30275101		1-	
C 6039	MICA CAP.	39pF	500V		LCQ12390J5	K30275390		1-	
C 6040	MICA CAP.	82pF	500V		LCQ12820J5	K30275820		1-	
C 6041	MICA CAP.	47pF	500V		LCQ12470J5	K30275470		1-	
C 6042	MICA CAP.	56pF	500V		LCQ12560J5	K30275560		1-	
C 6043	MICA CAP.	39pF	500V		LCQ12390J5	K30275390		1-	
C 6044	MICA CAP.	56pF	500V		LCQ12560J5	K30275560		1-	
C 6045	MICA CAP.	22pF	500V		LCQ12220J5	K30275220		1-	
C 6046	MICA CAP.	56pF	500V		LCQ12560J5	K30275560		1-	
C 6047	CHIPCAP.	0.047uF	50V	B	GRM40B473M50PT	K22170823		1-	
C 6048	CHIPCAP.	0.047uF	50V	B	GRM40B473M50PT	K22170823		1-	
C 6049	CHIPCAP.	0.047uF	50V	B	GRM40B473M50PT	K22170823		1-	
C 6050	CHIPCAP.	0.047uF	50V	B	GRM40B473M50PT	K22170823		1-	
C 6051	CHIPCAP.	0.047uF	50V	B	GRM40B473M50PT	K22170823		1-	
C 6052	CHIPCAP.	0.047uF	50V	B	GRM40B473M50PT	K22170823		1-	
C 6053	CHIPCAP.	0.047uF	50V	B	GRM40B473M50PT	K22170823		1-	
C 6054	CHIPCAP.	0.047uF	50V	B	GRM40B473M50PT	K22170823		1-	
C 6055	CHIPCAP.	0.047uF	50V	B	GRM40B473M50PT	K22170823		1-	
C 6056	CHIPCAP.	0.047uF	50V	B	GRM40B473M50PT	K22170823		1-	
C 6057	CHIPCAP.	0.047uF	50V	B	GRM40B473M50PT	K22170823		1-	
C 6058	CHIPCAP.	0.047uF	50V	B	GRM40B473M50PT	K22170823		1-	
C 6059	CHIPCAP.	0.047uF	50V	B	GRM40B473M50PT	K22170823		1-	
C 6060	CHIPCAP.	0.047uF	50V	B	GRM40B473M50PT	K22170823		1-	
C 6061	CERAMIC CAP.	200pF	50V	SL	DD106-979SL201J50	K26171036		1-	
C 6062	CHIPCAP.	0.01uF	50V	B	GRM40B103K50PT	K22170826		1-	
C 6063	CHIPCAP.	0.01uF	50V	B	GRM40B103K50PT	K22170826		1-	
C 6076	CHIPCAP.	0.047uF	50V	B	GRM40B473M50PT	K22170823		1-	
C 6077	CHIPCAP.	0.047uF	50V	B	GRM40B473M50PT	K22170823		1-	
C 6078	CHIPCAP.	0.047uF	50V	B	GRM40B473M50PT	K22170823		1-	

LPF-1 Unit

Parts List

REF.	DESCRIPTION	VALUE	V/W	TOL.	MFR'S DESIG	YAESU P/N	VERS.	LOT.	LAYADR
C 6079	CHIPCAP.	0.047uF	50V	B	GRM40B473M50PT	K22170823		1-	
C 6080	CHIPCAP.	0.047uF	50V	B	GRM40B473M50PT	K22170823		1-	
C 6083	CHIPCAP.	0.001uF	50V	B	GRM40B102K50PT	K22170825		1-	
C 6084	CHIPCAP.	0.001uF	50V	B	GRM40B102K50PT	K22170825		1-	
C 6085	CHIPCAP.	0.001uF	50V	B	GRM40B102K50PT	K22170825		1-	
C 6086	CHIPCAP.	0.001uF	50V	B	GRM40B102K50PT	K22170825		1-	
C 6087	CHIP TA.CAP.	10uF	10V		TEMSVA1A106M-8R	K78100028		1-	
C 6088	CHIPCAP.	0.01uF	50V	B	GRM40B103K50PT	K22170826		1-	
C 6089	MICAPAC.	12pF	500V		LCQ12120J5	K30275120		1-	
C 6090	CERAMIC.CAP.	0.047uF	50V	F	UP050F473Z-A-B	K28179002		1-	
D 6001	DIODE				HRF32-TR	G2070792		1-	a2
D 6002	DIODE				HRF32-TR	G2070792		1-	a2
D 6003	DIODE				HRF32-TR	G2070792		1-	b2
D 6004	DIODE				HRF32-TR	G2070792		1-	a2
D 6005	DIODE				02CZ5.1Y TE85R	G2070062		1-	a4
D 6006	DIODE				DAN202K T146	G2070182		1-	b4
D 6007	DIODE				DAN202K T146	G2070182		1-	b3
J 6001	CONNECTOR				S-Q3063#01	P1090295		1-	
J 6002	CONNECTOR				SC25-06WS	P0090625		1-	
J 6003	CONNECTOR				SC25-05WS	P0090624		1-	
J 6004	CONNECTOR				SC25-04WS	P0090623		1-	
J 6005	CONNECTOR				S-Q3063#01	P1090295		1-	
J 6006	CONNECTOR				SC25-02WS	P0090621		1-	
L 6001	TOROIDAL COIL	3.74uH			3.74U T-80-2	L0021976		1-	
L 6002	TOROIDAL COIL	4.57uH			4.57U T-80-2	L0021977		1-	
L 6003	TOROIDAL COIL	1.55uH			1.55U T-80-2	L0021980		1-	
L 6004	TOROIDAL COIL	1.92uH			1.92U T-80-2	L0021981		1-	
L 6005	TOROIDAL COIL	0.97uH			0.97U T-80-2	L0021982		1-	
L 6006	TOROIDAL COIL	1.27uH			1.27U T-80-2	L0021983		1-	
L 6007	TOROIDAL COIL	0.74uH			0.74U T80-2	L0022100		1-	
L 6008	TOROIDAL COIL	0.91uH			0.91U T80-2	L0022101		1-	
L 6009	TOROIDAL COIL	0.54uH			0.54U T-80-6	L0021986		1-	
L 6010	TOROIDAL COIL	0.65uH			0.65U T-80-6	L0021987		1-	
L 6011	COIL B1				6.0T11.5D1.2UEW R	L0021988A		1-	
L 6012	COIL B1				6.0T12.5D1.2UEW R	L0021989A		1-	
L 6013	COIL B1				5.0T10.0D1.2UEW R	L0021990A		1-	
L 6014	COIL B1				5.0T11.5D1.2UEW R	L0021991A		1-	
L 6015	TOROIDAL COIL				U 2001F FR9.5	L0021956		1-	
L 6016	M.RFC	1mH			LAL03NA102K	L1190189		1-	
L 6017	M.RFC	1mH			LAL03NA102K	L1190189		1-	
Q 6001	IC				TD62783F TP1	G1091620		1-	a3
Q 6002	IC				TC4028BF TP2	G1091157		1-	a4
Q 6002	IC				TC4028BF(EL.N)	G1093433		24-	a4
R 6001	METAL FILM RES.	100	2W	5%	ERG-2SJ101 100	J22335101		1-	
R 6010	CHIPRES.	100k	1/10W	5%	RMC1/10T 104J	J24205104		1-	
R 6011	CHIPRES.	100k	1/10W	5%	RMC1/10T 104J	J24205104		1-	
R 6012	CHIPRES.	1k	1/10W	5%	RMC1/10T 102J	J24205102		1-	
R 6013	CHIPRES.	0	1/10W	5%	RMC1/10T 000J	J24205000		1-	
R 6014	CHIPRES.	0	1/10W	5%	RMC1/10T 000J	J24205000		1-	
R 6015	CHIPRES.	100k	1/10W	5%	RMC1/10T 104J	J24205104		1-	
R 6016	CHIPRES.	100k	1/10W	5%	RMC1/10T 104J	J24205104		1-	
R 6017	CHIPRES.	100k	1/10W	5%	RMC1/10T 104J	J24205104		1-	
R 6018	CHIPRES.	100k	1/10W	5%	RMC1/10T 104J	J24205104		1-	
R 6019	CHIPRES.	100k	1/10W	5%	RMC1/10T 104J	J24205104		1-	
R 6020	CHIPRES.	100k	1/10W	5%	RMC1/10T 104J	J24205104		1-	
RL6001	RELAY		DC12V		AGP2013 DC12V	M1190069		1-	
RL6002	RELAY		DC12V		AGP2013 DC12V	M1190069		1-	
RL6003	RELAY		DC12V		AGP2013 DC12V	M1190069		1-	
RL6004	RELAY		DC12V		AGP2013 DC12V	M1190069		1-	
RL6005	RELAY		DC12V		AGP2013 DC12V	M1190069		1-	
RL6006	RELAY		DC12V		AGP2013 DC12V	M1190069		1-	
RL6007	RELAY		DC12V		AGP2013 DC12V	M1190069		1-	
RL6008	RELAY		DC12V		AGP2013 DC12V	M1190069		1-	
RL6009	RELAY		DC12V		AGP2013 DC12V	M1190069		1-	
RL6010	RELAY		DC12V		AGP2013 DC12V	M1190069		1-	
RL6011	RELAY		DC12V		AGP2013 DC12V	M1190069		1-	
RL6012	RELAY		DC12V		AGP2013 DC12V	M1190069		1-	
RL6013	RELAY		DC12V		AGP2013 DC12V	M1190069		1-	

LPF-1 Unit

Parts List

REF.	DESCRIPTION	VALUE	V/W	TOL.	MFR'S DESIG	YAESU P/N	VERS.	LOT.	LAY ADR
RL6014	RELAY		DC12V		AGP2013 DC12V	M1190069		1-	
TC6001	TRIMMERCAP. SHIELDPLATE	20pF			ECV1ZW20X53T 20PF	K91000029 R0146381		1- 1-	

LPF-1 Unit

Notes

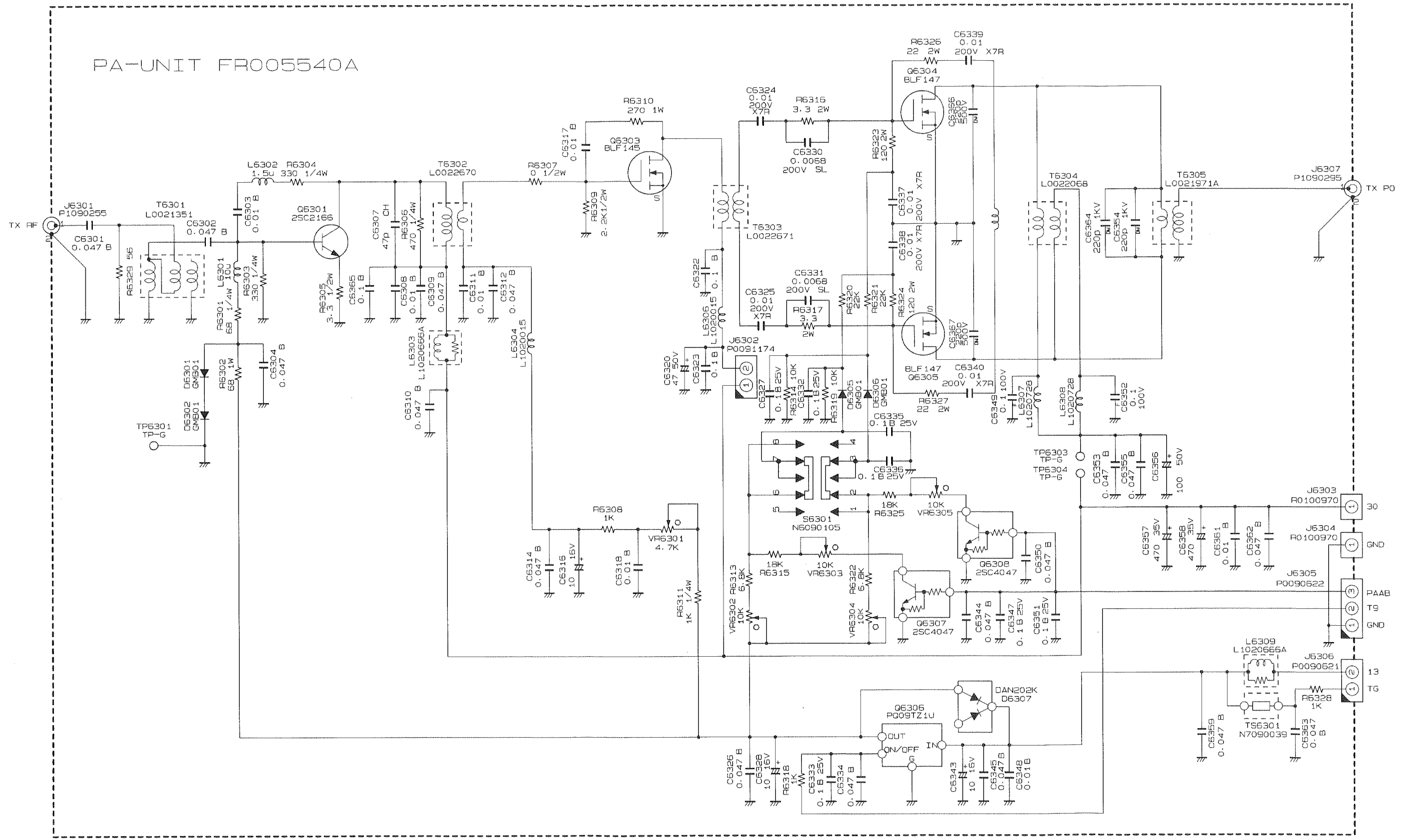

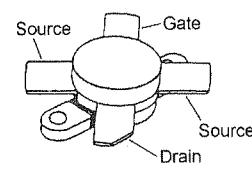
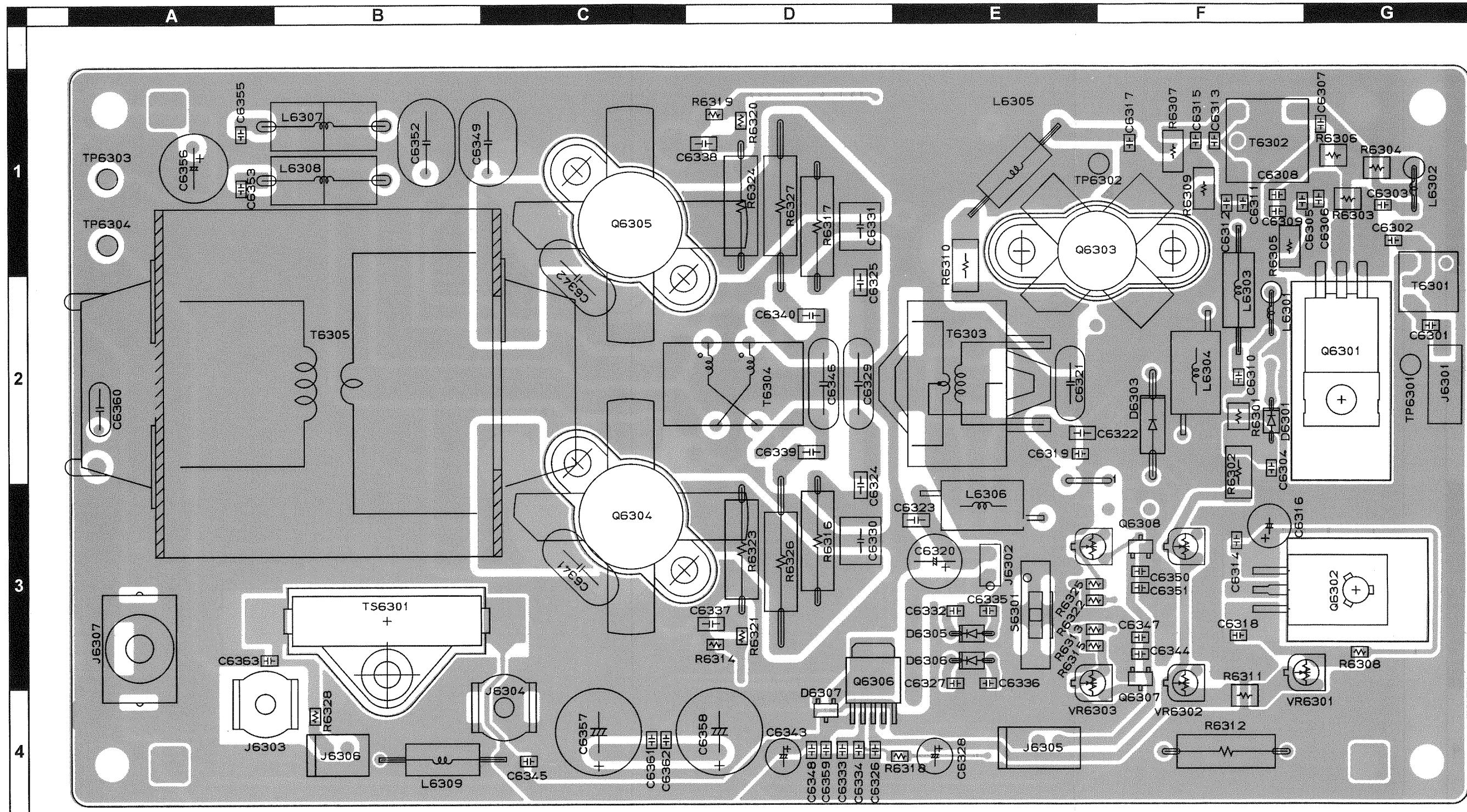

BLF145
(Q6303)

BLF147
(Q6304, 6305)

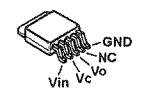

PQ09TZ1U
(Q6306)

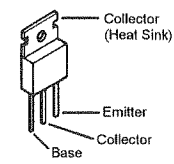

2SC2166
(Q6301)

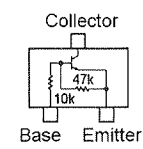

2SC4047-TA (ZY)
(Q6307, 6308)

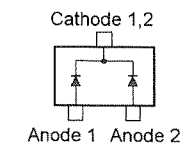

DAN202K
(D6307)

Side A

PA Unit (Lot. 1~)

Parts Layout

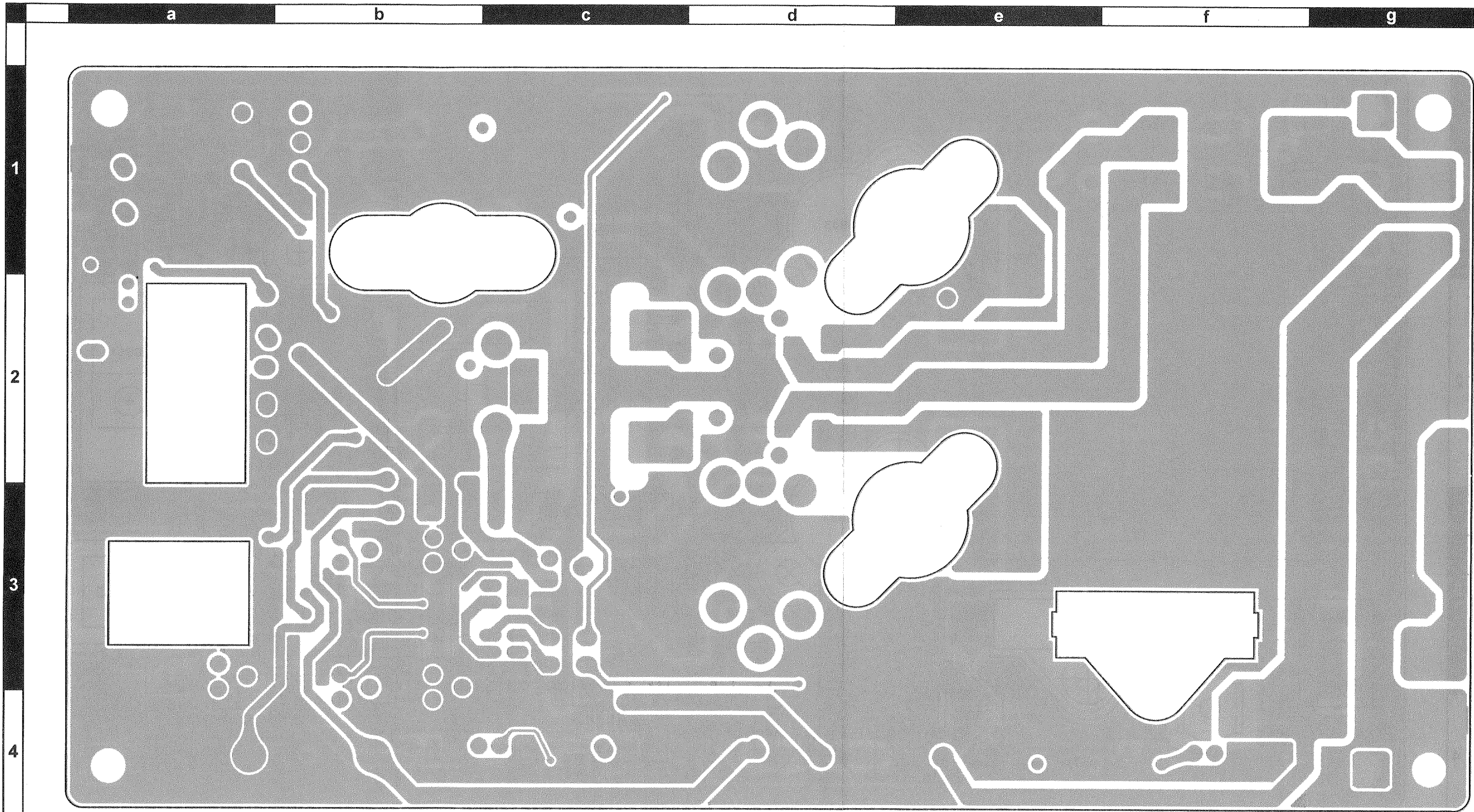

Side B

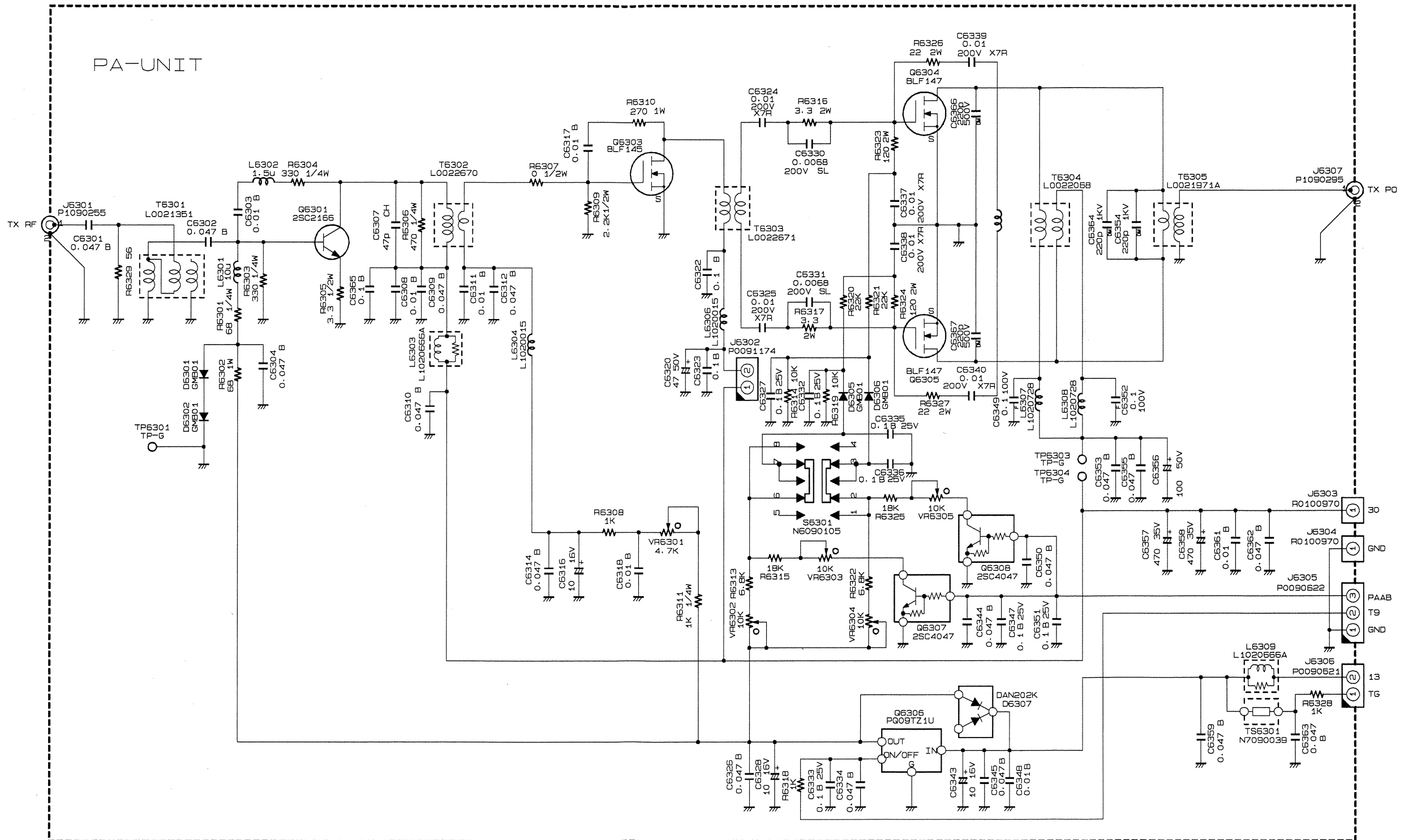

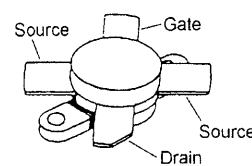
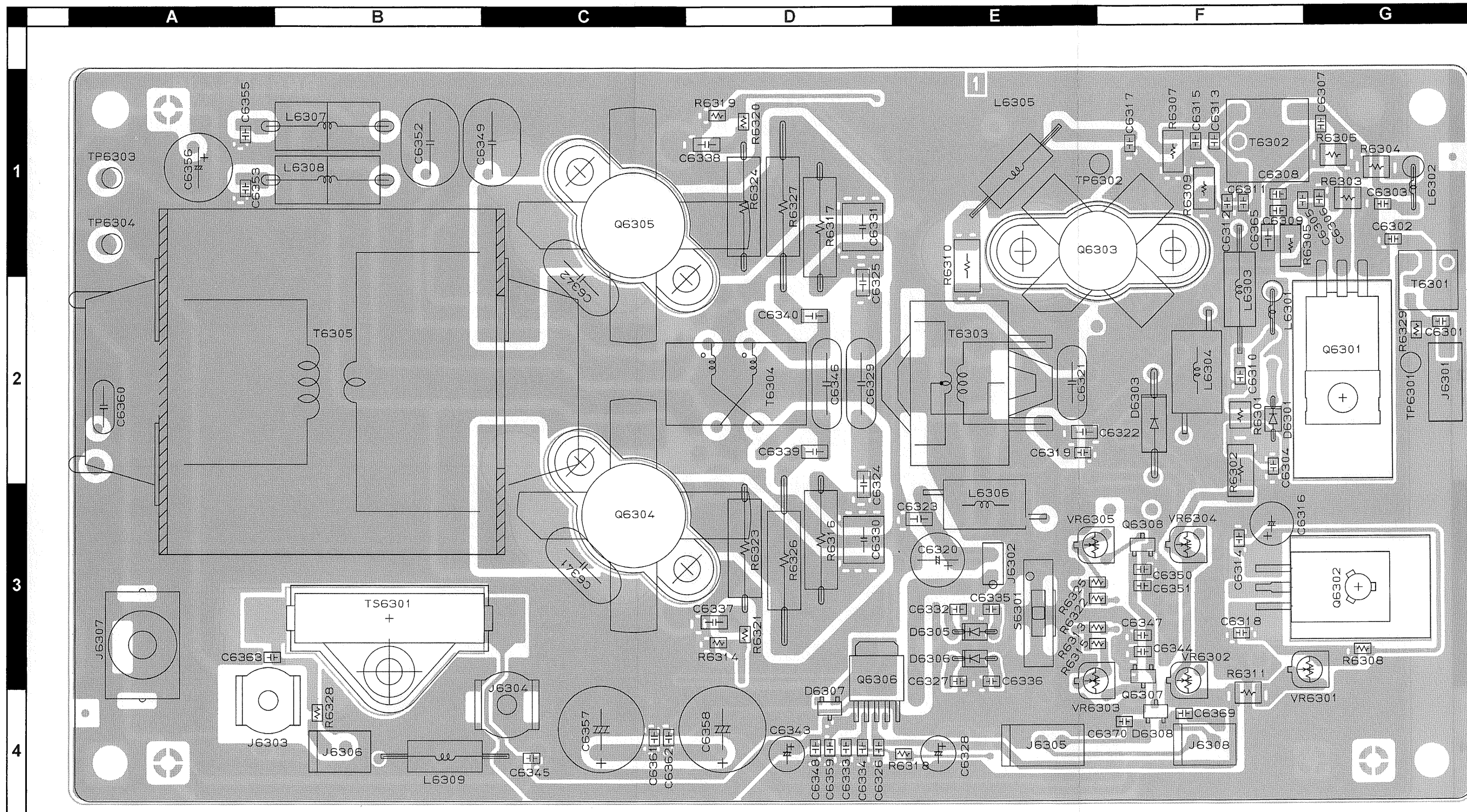

BLF145
(Q6303)

BLF147
(Q6304, 6305)

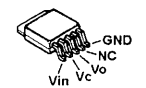

PQ09TZ1U
(Q6306)

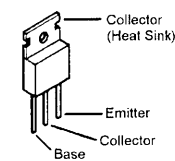

2SC2166
(Q6301)

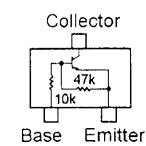

2SC4047-TA (ZY)
(Q6307, 6308)

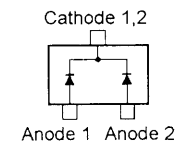

DAN202K
(D6307)

Side A

PA Unit (Lot. 20~)
Parts Layout

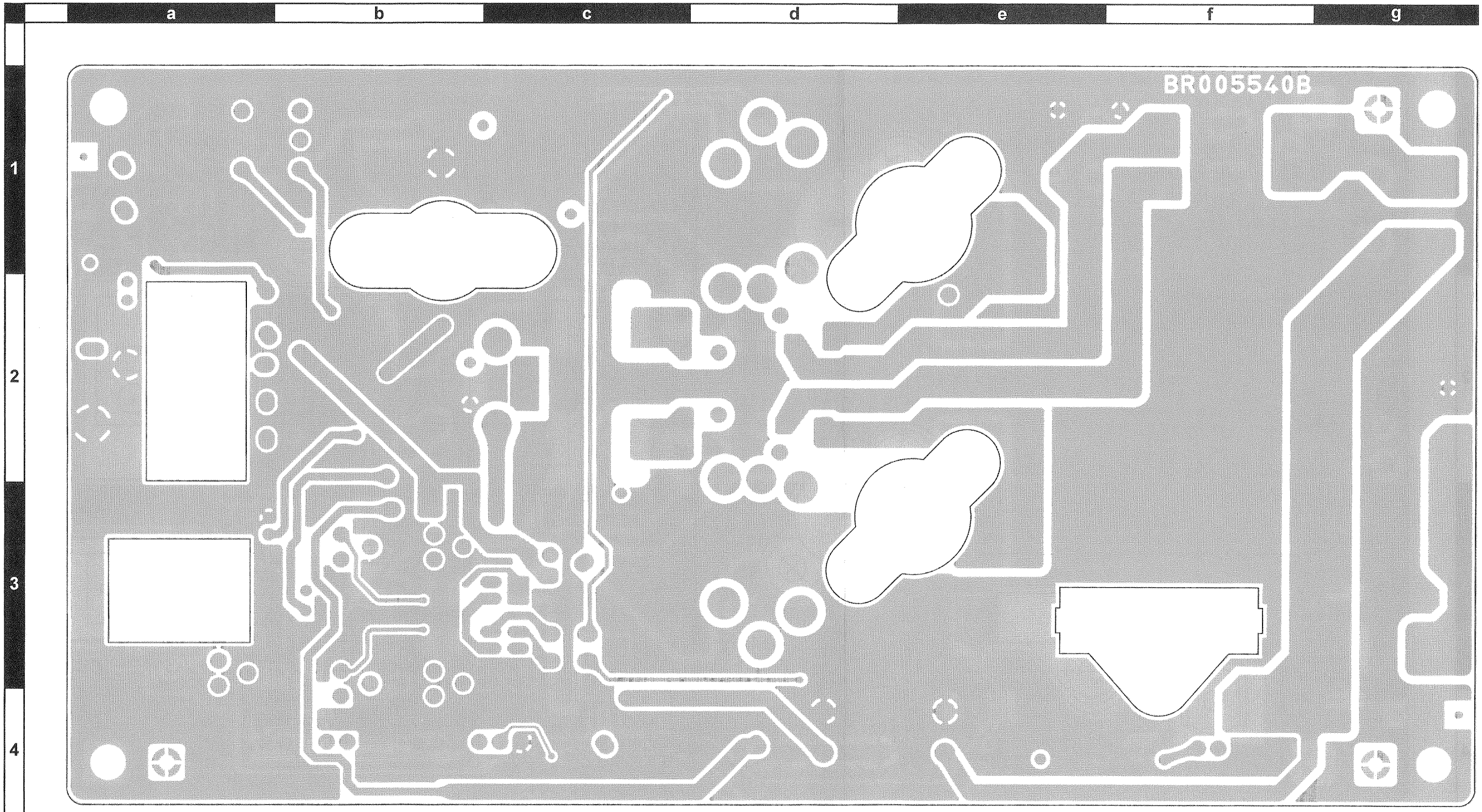

Side B

PA Unit

Parts List

REF.	DESCRIPTION	VALUE	V/W	TOL.	MFR'S DESIG	YAESU P/N	VERS.	LOT.	LAY ADR
PCB with Components						CS1715001			
Printed Circuit Board						FR005540A		1-	
Printed Circuit Board						FR005540B		20-	
C 6301	CHIP CAP.	0.047uF	50V	B	GRM40B473M50PT	K22170823		1-	
C 6302	CHIP CAP.	0.047uF	50V	B	GRM40B473M50PT	K22170823		1-	
C 6303	CHIP CAP.	0.01uF	50V	B	GRM40B103M50PT	K22170817		1-	
C 6304	CHIP CAP.	0.047uF	50V	B	GRM40B473M50PT	K22170823		1-	
C 6307	CHIP CAP.	47pF	50V	CH	GRM40CH470J50PT	K22170227		1-	
C 6308	CHIP CAP.	0.01uF	50V	B	GRM40B103M50PT	K22170817		1-	
C 6309	CHIP CAP.	0.047uF	50V	B	GRM40B473M50PT	K22170823		1-	
C 6310	CHIP CAP.	0.047uF	50V	B	GRM40B473M50PT	K22170823		1-	
C 6311	CHIP CAP.	0.01uF	50V	B	GRM40B103M50PT	K22170817		1-	
C 6312	CHIP CAP.	0.047uF	50V	B	GRM40B473M50PT	K22170823		1-	
C 6314	CHIP CAP.	0.047uF	50V	B	GRM40B473M50PT	K22170823		1-	
C 6317	CHIP CAP.	0.01uF	50V	B	GRM40B103M50PT	K22170817		1-	
C 6318	CHIP CAP.	0.01uF	50V	B	GRM40B103M50PT	K22170817		1-	
C 6320	AL.ELECTRO.CAP.	47uF	50V		50V470M6X11TR5	K46170024		1-	
C 6322	CHIP CAP.	0.1uF	50V	B	GRM42-6B104K50PT	K22171820		1-	
C 6323	CHIP CAP.	0.1uF	50V	B	GRM42-6B104K50PT	K22171820		1-	
C 6324	CHIP CAP.	0.01uF	200V	X7R	GRM42-6X7R103K200PT	K22231802		1-	
C 6325	CHIP CAP.	0.01uF	200V	X7R	GRM42-6X7R103K200PT	K22231802		1-	
C 6326	CHIP CAP.	0.047uF	50V	B	GRM40B473M50PT	K22170823		1-	
C 6327	CHIP CAP.	0.1uF	25V	B	GRM40B104M25PT	K22140811		1-	
C 6328	AL.ELECTRO.CAP.	10uF	16V		16V100M4X7TR2	K46120004		1-	
C 6330	CERAMIC CAP.	0.0068uF	200V	SL	GRM44-1SL682J200PT	K22236101		1-	
C 6331	CERAMIC CAP.	0.0068uF	200V	SL	GRM44-1SL682J200PT	K22236101		1-	
C 6332	CHIP CAP.	0.1uF	25V	B	GRM40B104M25PT	K22140811		1-	
C 6333	CHIP CAP.	0.1uF	25V	B	GRM40B104M25PT	K22140811		1-	
C 6334	CHIP CAP.	0.047uF	50V	B	GRM40B473M50PT	K22170823		1-	
C 6335	CHIP CAP.	0.1uF	25V	B	GRM40B104M25PT	K22140811		1-	
C 6336	CHIP CAP.	0.1uF	25V	B	GRM40B104M25PT	K22140811		1-	
C 6337	CHIP CAP.	0.01uF	200V	X7R	GRM42-6X7R103K200PT	K22231802		1-	
C 6338	CHIP CAP.	0.01uF	200V	X7R	GRM42-6X7R103K200PT	K22231802		1-	
C 6339	CHIP CAP.	0.01uF	200V	X7R	GRM42-6X7R103K200PT	K22231802		1-	
C 6340	CHIP CAP.	0.01uF	200V	X7R	GRM42-6X7R103K200PT	K22231802		1-	
C 6343	AL.ELECTRO.CAP.	10uF	16V		16V100M4X7TR2	K46120004		1-	
C 6344	CHIP CAP.	0.047uF	50V	B	GRM40B473M50PT	K22170823		1-	
C 6345	CHIP CAP.	0.047uF	50V	B	GRM40B473M50PT	K22170823		1-	
C 6347	CHIP CAP.	0.1uF	25V	B	GRM40B104M25PT	K22140811		1-	
C 6348	CHIP CAP.	0.01uF	50V	B	GRM40B103M50PT	K22170817		1-	
C 6349	FILM CAP.	0.1uF	100V		ECQ-B1104JF	K50205104		1-	
C 6350	CHIP CAP.	0.047uF	50V	B	GRM40B473M50PT	K22170823		1-	
C 6351	CHIP CAP.	0.1uF	25V	B	GRM40B104M25PT	K22140811		1-	
C 6352	FILM CAP.	0.1uF	100V		ECQ-B1104JF	K50205104		1-	
C 6353	CHIP CAP.	0.047uF	50V	B	GRM40B473M50PT	K22170823		1-	
C 6354	MICA CAP.	220pF	1KV		DML2 221J10	K30309051		1-	
C 6355	CHIP CAP.	0.047uF	50V	B	GRM40B473M50PT	K22170823		1-	
C 6356	AL.ELECTRO.CAP.	100uF	50V		50V101M8X11TR5	K46170025		1-	
C 6357	AL.ELECTRO.CAP.	470uF	35V		RE2-35V471M 470UF	K40169026		1-	
C 6358	AL.ELECTRO.CAP.	470uF	35V		RE2-35V471M 470UF	K40169026		1-	
C 6359	CHIP CAP.	0.047uF	50V	B	GRM40B473M50PT	K22170823		1-	
C 6361	CHIP CAP.	0.01uF	50V	B	GRM40B103M50PT	K22170817		1-	
C 6362	CHIP CAP.	0.047uF	50V	B	GRM40B473M50PT	K22170823		1-	
C 6363	CHIP CAP.	0.047uF	50V	B	GRM40B473M50PT	K22170823		1-	
C 6364	MICA CAP.	220pF	1KV		DML2 221J10	K30309051		1-	
C 6365	CHIP CAP.	0.1uF	50V	B	GRM42-6B104K50PT	K22171820		1-	
C 6366	MICA CAP.	220pF	500V		DM15D221J5	K30279081		1-	
C 6367	MICA CAP.	220pF	500V		DM15D221J5	K30279081		1-	
C 6369	CHIP CAP.	0.01uF	50V	B	GRM39B103M50PT	K22174823		20-	
C 6370	CHIP CAP.	0.01uF	50V	B	GRM39B103M50PT	K22174823		20-	
D 6301	DIODE				GMB01-BT	G2060016		1-	F2
D 6301	DIODE				GMA01U-BT	G2060023		11-	F2
D 6302	DIODE				GMB01-BT	G2060016		1-	
D 6302	DIODE				GMA01U-BT	G2060023		11-	
D 6305	DIODE				GMB01-BT	G2060016		1-	E3
D 6305	DIODE				GMA01U-BT	G2060023		11-	E3
D 6306	DIODE				GMB01-BT	G2060016		1-	E3
D 6306	DIODE				GMA01U-BT	G2060023		11-	E3

PA Unit

Parts List

REF.	DESCRIPTION	VALUE	V/W	TOL.	MFR'S DESIG	YAESU P/N	VERS.	LOT.	LAYADR
D 6307	DIODE				DAN202K T146	G2070182		1-	D4
D 6308	DIODE				DAN202K T146	G2070182		20-	D4
J 6301	CONNECTOR				TMP-J01X-A2	P1090255		1-	
J 6302	CONNECTOR				IMSA-9202B-1-02-T	P0091174		1-	
J 6303	TERMINAL					R0100970		1-	
J 6304	TERMINAL					R0100970		1-	
J 6305	CONNECTOR				SC25-03WS	P0090622		1-	
J 6306	CONNECTOR				SC25-02WS	P0090621		1-	
J 6307	CONNECTOR				S-Q3063#01	P1090295		1-	
J 6308	CONNECTOR				SC25-02WS	P0090621		20-	
JP6301	JUMPER WIRE C				0.6-15.0	Q6100001		1-	
L 6301	M.RFC	10uH			LAL03VB100K	L1790140		1-	
L 6302	M.RFC	1.5uH			LAL03VB1R5M	L1790130		1-	
L 6303	RFC A1				43T0.16 4X9CB-20	L1020666A		1-	
L 6304	RFC WITH BEADS				FB-43-5111	L1020015		1-	
L 6306	RFC WITH BEADS				FB-43-5111	L1020015		1-	
L 6307	RFC WITH BEADS				3A R15.8X6.4-2	L1020728		1-	
L 6308	RFC WITH BEADS				3A R15.8X6.4-2	L1020728		1-	
L 6309	RFC A1				43T0.16 4X9CB-20	L1020666A		1-	
P 6301	CONNECTOR				IMSA-9206H-T	P1090988		1-	
Q 6301	TRANSISTOR				2SC2166	G3321660		1-	G2
Q 6303	FET				BLF145	G3090135		1-	E1
Q 6304	FET				BLF147	G3090133		1-	C3
Q 6305	FET				BLF147	G3090133		1-	C1
Q 6306	IC				PQ09TZ1U	G1092599		1-	D3
Q 6307	TRANSISTOR				2SC4047-TA	G3340477		1-	F3
Q 6307	TRANSISTOR				UN2214-(TX)	G3070206		8-	F3
Q 6308	TRANSISTOR				2SC4047-TA	G3340477		1-	F3
Q 6308	TRANSISTOR				UN2214-(TX)	G3070206		8-	F3
R 6301	CHIP RES.	68	1/4W	5%	RMC1/4 680JATP	J24245680		1-	
R 6302	CHIP RES.	68	1W	5%	RMC1 680JTE	J24305680		1-	
R 6303	CHIP RES.	330	1/4W	5%	RMC1/4 331JATP	J24245331		1-	
R 6304	CHIP RES.	330	1/4W	5%	RMC1/4 331JATP	J24245331		1-	
R 6305	CHIP RES.	3.3	1/2W	5%	RMC1/2 3R3JCTP	J24275339		1-	
R 6306	CHIP RES.	470	1/4W	5%	RMC1/4 471JATP	J24245471		1-	
R 6307	CHIP RES.	0	1/2W	5%	RMC1/2 JPATE	J24275000		1-	
R 6308	CHIP RES.	1k	1/10W	5%	RMC1/10T 102J	J24205102		1-	
R 6309	CHIP RES.	2.2k	1/2W	5%	RMC1/2 222JCTP	J24275222		1-	
R 6310	CHIP RES.	270	1W	5%	ERJ1WYJ271U	J24309020		1-	
R 6310	CHIP RES.	270	1W	5%	RMC1 271JTE	J24305271		30-	
R 6311	CHIP RES.	1k	1/4W	5%	RMC1/4 102JATP	J24245102		1-	
R 6313	CHIP RES.	6.8k	1/10W	5%	RMC1/10T 682J	J24205682		1-	
R 6314	CHIP RES.	10k	1/10W	5%	RMC1/10T 103J	J24205103		1-	
R 6315	CHIP RES.	18k	1/10W	5%	RMC1/10T 183J	J24205183		1-	
R 6315	CHIP RES.	27k	1/10W	5%	RMC1/10T 273J	J24205273		9-	
R 6316	METAL FILM RES.	3.3	2W	5%	ERX-2SJ3R3P 3.3	J22339003		1-	
R 6317	METAL FILM RES.	3.3	2W	5%	ERX-2SJ3R3P 3.3	J22339003		1-	
R 6318	CHIP RES.	1k	1/10W	5%	RMC1/10T 102J	J24205102		1-	
R 6319	CHIP RES.	10k	1/10W	5%	RMC1/10T 103J	J24205103		1-	
R 6320	CHIP RES.	22k	1/10W	5%	RMC1/10T 223J	J24205223		1-	
R 6321	CHIP RES.	22k	1/10W	5%	RMC1/10T 223J	J24205223		1-	
R 6322	CHIP RES.	6.8k	1/10W	5%	RMC1/10T 682J	J24205682		1-	
R 6323	METAL FILM RES.	120	2W	5%	ERG-2SJ121P 120	J22339015		1-	
R 6324	METAL FILM RES.	120	2W	5%	ERG-2SJ121P 120	J22339015		1-	
R 6325	CHIP RES.	18k	1/10W	5%	RMC1/10T 183J	J24205183		1-	
R 6325	CHIP RES.	27k	1/10W	5%	RMC1/10T 273J	J24205273		9-	
R 6326	METAL FILM RES.	22	2W	5%	ERG-2SJ220P 22	J22339014		1-	
R 6326	METAL FILM RES.	22	3W	5%	ERG-3SJ220P 22	J22359025		7-	
R 6327	METAL FILM RES.	22	2W	5%	ERG-2SJ220P 22	J22339014		1-	
R 6327	METAL FILM RES.	22	3W	5%	ERG-3SJ220P 22	J22359025		7-	
R 6328	CHIP RES.	1k	1/10W	5%	RMC1/10T 102J	J24205102		1-	
R 6329	CARBON FILM RES.	56	1/6W	5%	RD16TPJ560 56	J07225560		1-	
R 6329	CHIP RES.	56	1/10W	5%	RMC1/10T 560J	J24205560		20-	
S 6301	SLIDE SWITCH				SSSS223-01-A	N6090105		1-	
T 6301	COIL 07WIDE				4-1 2001F FR6	L0021351		1-	
T 6302	COIL 10WIDE				1-3 3A6 RIB4X7X5	L0022670		1-	
T 6303	COIL PWR-WIDE				3A5 RIB10X20X10	L0022671		1-	
T 6304	COIL PWR-WIDE				D12A TR16	L0022068		1-	

PA Unit

Parts List

REF.	DESCRIPTION	VALUE	V/W	TOL.	MFR'S DESIG	YAESU P/N	VERS.	LOT.	LAY ADR
T 6305	COIL PWR-WIDE				D12A RIB21	L0021971A		1-	
T 6305	COIL PWR-WIDE				D12A RIB21X42X40	L0022731		31-	
TP6301	TERMINAL				TP-G MK1095	Q5000036		1-	
TP6303	TERMINAL				TP-G MK1095	Q5000036		1-	
TP6304	TERMINAL				TP-G MK1095	Q5000036		1-	
TS6301	THERMAL SWITCH				OHD3-40M	N7090039		1-	
VR6301	POT.	4.7k			RH0421CS3J 4.7KB	J51798472		1-	
VR6301	POT.	4.7k			RH0411CS3J 4.7KB	J51827472		30-	
VR6302	POT.	10k			RH0411C14J 10K	J51776103		1-	
VR6303	POT.	10k			RH0411C14J 10K	J51776103		1-	
VR6304	POT.	10k			RH0411C14J 10K	J51776103		1-	
VR6305	POT.	10k			RH0411C14J 10K	J51776103		1-	

PA Unit

Note

TUNER-MAIN Unit

Circuit Diagram

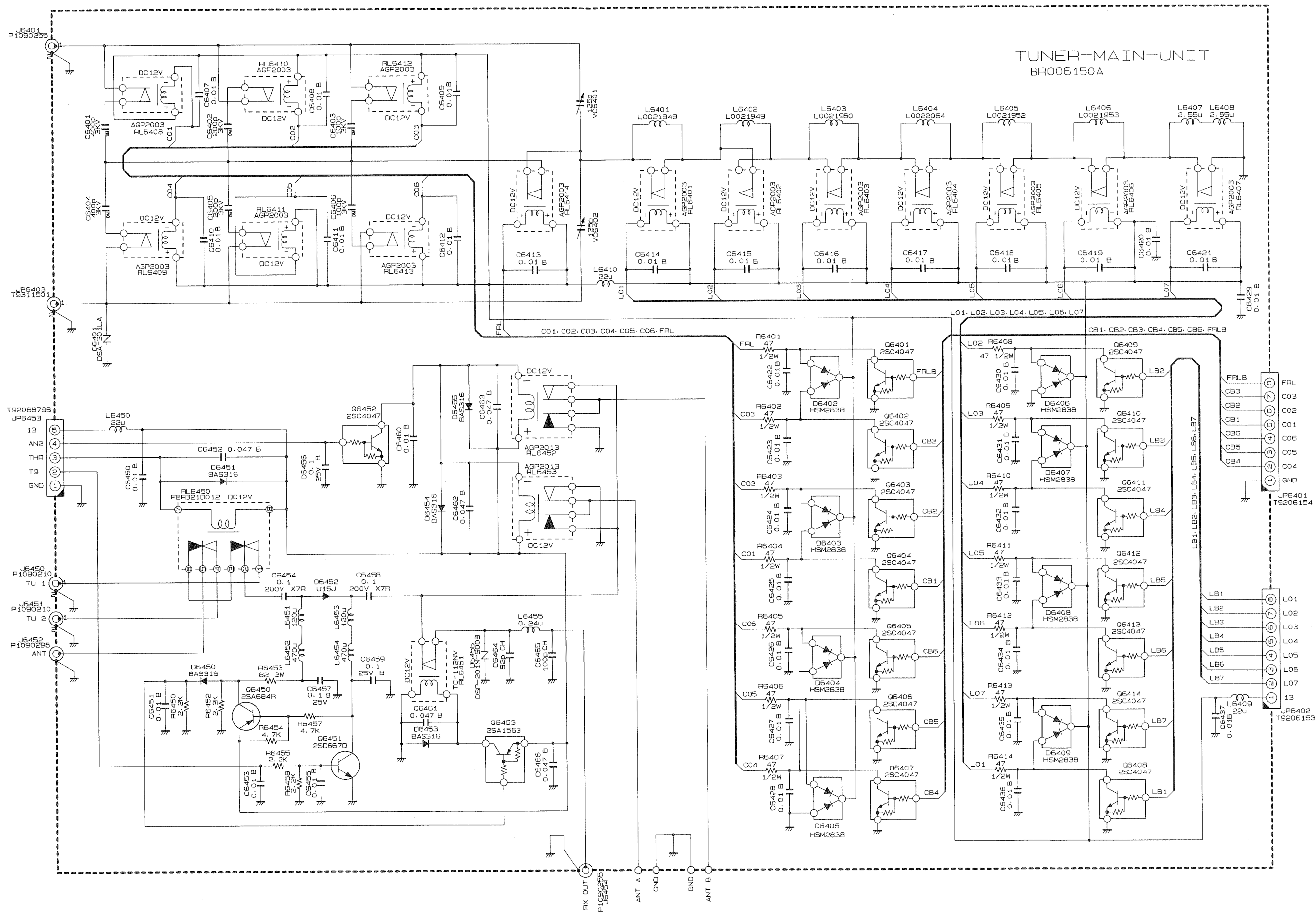

TUNER-MAIN Unit

Parts Layout

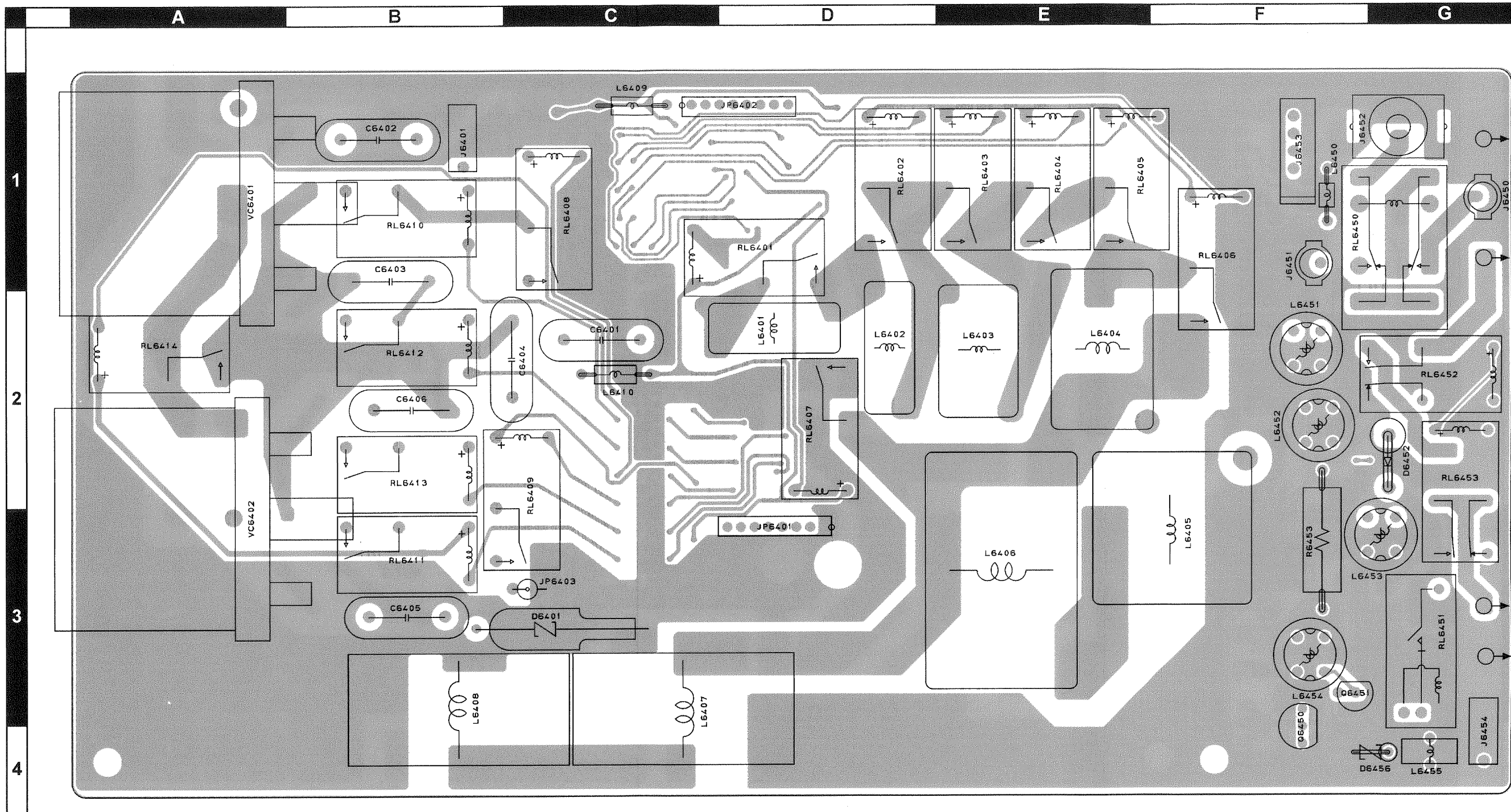

Side A

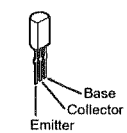

- 2SA684R
(Q6450)
- 2SD667D
(Q6451)

TUNER-MAIN Unit

Parts Layout

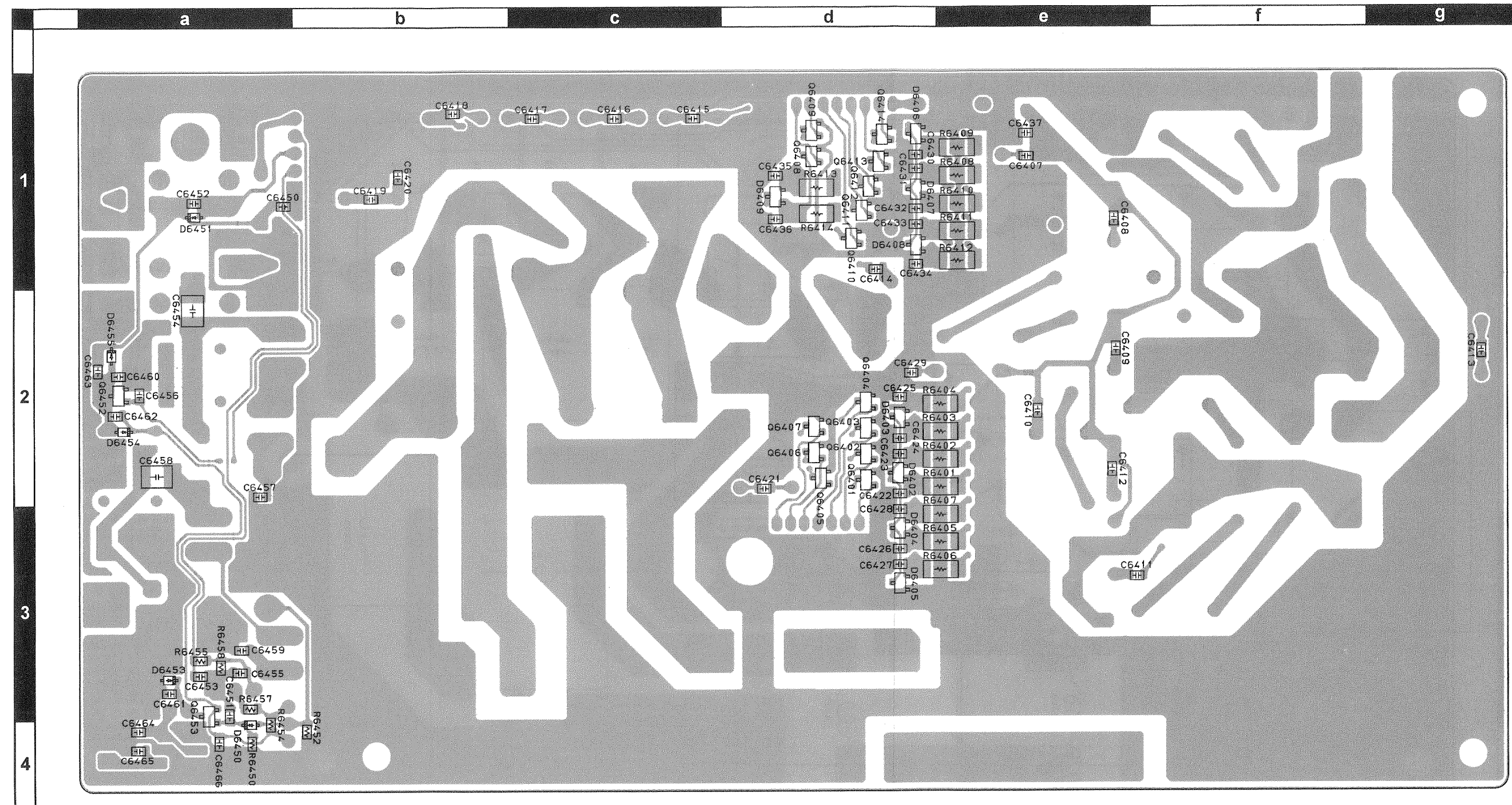

Side B

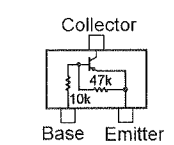

2SA1563 (RL)
(Q6453)

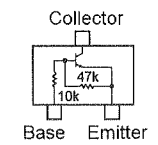

2SC4047 (ZY)
(Q6401, 6402, 6403,
6404, 6405, 6406,
6407, 6408, 6409,
6410, 6411, 6412,
6413, 6414, 6452)

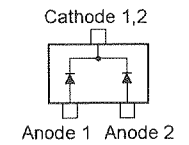

HSM2838 (A6)
(D6402, 6403,
6405, 6406, 6407,
6408, 6409)

REF.	DESCRIPTION	VALUE	V/W	TOL.	MFR'S DESIG	YAESU P/N	VERS.	LOT.	LAY ADR
PCB with Components						CB1198001			
Printed Circuit Board						FR006150A			
C 6401	MICAP.	400pF	3KV		DML4 401J30	K30355401		1-	
C 6402	MICAP.	200pF	3KV		DML4 201J30	K30355201		1-	
C 6403	MICAP.	100pF	3KV		DML4 101J30	K30355101		1-	
C 6404	MICAP.	400pF	3KV		DML4 401J30	K30355401		1-	
C 6405	MICAP.	200pF	3KV		DML4 201J30	K30355201		1-	
C 6406	MICAP.	100pF	3KV		DML4 101J30	K30355101		1-	
C 6407	CHIPCAP.	0.01uF	50V	B	GRM40B103M50PT	K22170817		1-	
C 6408	CHIPCAP.	0.01uF	50V	B	GRM40B103M50PT	K22170817		1-	
C 6409	CHIPCAP.	0.01uF	50V	B	GRM40B103M50PT	K22170817		1-	
C 6410	CHIPCAP.	0.01uF	50V	B	GRM40B103M50PT	K22170817		1-	
C 6411	CHIPCAP.	0.01uF	50V	B	GRM40B103M50PT	K22170817		1-	
C 6412	CHIPCAP.	0.01uF	50V	B	GRM40B103M50PT	K22170817		1-	
C 6413	CHIPCAP.	0.01uF	50V	B	GRM40B103M50PT	K22170817		1-	
C 6414	CHIPCAP.	0.01uF	50V	B	GRM40B103M50PT	K22170817		1-	
C 6415	CHIPCAP.	0.01uF	50V	B	GRM40B103M50PT	K22170817		1-	
C 6416	CHIPCAP.	0.01uF	50V	B	GRM40B103M50PT	K22170817		1-	
C 6417	CHIPCAP.	0.01uF	50V	B	GRM40B103M50PT	K22170817		1-	
C 6418	CHIPCAP.	0.01uF	50V	B	GRM40B103M50PT	K22170817		1-	
C 6419	CHIPCAP.	0.01uF	50V	B	GRM40B103M50PT	K22170817		1-	
C 6420	CHIPCAP.	0.01uF	50V	B	GRM40B103M50PT	K22170817		1-	
C 6421	CHIPCAP.	0.01uF	50V	B	GRM40B103M50PT	K22170817		1-	
C 6422	CHIPCAP.	0.01uF	50V	B	GRM40B103M50PT	K22170817		1-	
C 6423	CHIPCAP.	0.01uF	50V	B	GRM40B103M50PT	K22170817		1-	
C 6424	CHIPCAP.	0.01uF	50V	B	GRM40B103M50PT	K22170817		1-	
C 6425	CHIPCAP.	0.01uF	50V	B	GRM40B103M50PT	K22170817		1-	
C 6426	CHIPCAP.	0.01uF	50V	B	GRM40B103M50PT	K22170817		1-	
C 6427	CHIPCAP.	0.01uF	50V	B	GRM40B103M50PT	K22170817		1-	
C 6428	CHIPCAP.	0.01uF	50V	B	GRM40B103M50PT	K22170817		1-	
C 6429	CHIPCAP.	0.01uF	50V	B	GRM40B103M50PT	K22170817		1-	
C 6430	CHIPCAP.	0.01uF	50V	B	GRM40B103M50PT	K22170817		1-	
C 6431	CHIPCAP.	0.01uF	50V	B	GRM40B103M50PT	K22170817		1-	
C 6432	CHIPCAP.	0.01uF	50V	B	GRM40B103M50PT	K22170817		1-	
C 6433	CHIPCAP.	0.01uF	50V	B	GRM40B103M50PT	K22170817		1-	
C 6434	CHIPCAP.	0.01uF	50V	B	GRM40B103M50PT	K22170817		1-	
C 6435	CHIPCAP.	0.01uF	50V	B	GRM40B103M50PT	K22170817		1-	
C 6436	CHIPCAP.	0.01uF	50V	B	GRM40B103M50PT	K22170817		1-	
C 6437	CHIPCAP.	0.01uF	50V	B	GRM40B103M50PT	K22170817		1-	
C 6450	CHIPCAP.	0.01uF	50V	B	GRM40B103M50PT	K22170817		1-	
C 6451	CHIPCAP.	0.01uF	50V	B	GRM40B103M50PT	K22170817		1-	
C 6452	CHIPCAP.	0.047uF	50V	B	GRM40B473M50PT	K22170823		1-	
C 6453	CHIPCAP.	0.01uF	50V	B	GRM40B103M50PT	K22170817		1-	
C 6454	CHIPCAP.	0.1uF	200V	X7R	GRM43-2X7R104K200PT	K22237801		1-	
C 6455	CHIPCAP.	0.01uF	50V	B	GRM40B103M50PT	K22170817		1-	
C 6456	CHIPCAP.	0.1uF	25V	B	GRM40B104M25PT	K22140811		1-	
C 6457	CHIPCAP.	0.1uF	25V	B	GRM40B104M25PT	K22140811		1-	
C 6458	CHIPCAP.	0.1uF	200V	X7R	GRM43-2X7R104K200PT	K22237801		1-	
C 6459	CHIPCAP.	0.1uF	25V	B	GRM40B104M25PT	K22140811		1-	
C 6460	CHIPCAP.	0.01uF	50V	B	GRM40B103M50PT	K22170817		1-	
C 6461	CHIPCAP.	0.047uF	50V	B	GRM40B473M50PT	K22170823		1-	
C 6462	CHIPCAP.	0.047uF	50V	B	GRM40B473M50PT	K22170823		1-	
C 6463	CHIPCAP.	0.047uF	50V	B	GRM40B473M50PT	K22170823		1-	
C 6464	CHIPCAP.	82pF	50V	CH	GRM40CH820J50PT	K22170233		1-	
C 6465	CHIPCAP.	100pF	50V	CH	GRM40CH101J50PT	K22170235		1-	
C 6466	CHIPCAP.	0.047uF	50V	B	GRM40B473M50PT	K22170823		1-	
D 6401	SURGEABSORBER				DSA-301LA	Q9000371		1-	C3
D 6401	SURGEABSORBER				CSB-301M-N	Q9000763		17-	C3
D 6402	DIODE				HSM2838-TR	G2070108		1-	d2
D 6402	DIODE				MA152WK-(TX)	G2070818		14-	d2
D 6403	DIODE				HSM2838-TR	G2070108		1-	d2
D 6403	DIODE				MA152WK-(TX)	G2070818		14-	d2
D 6404	DIODE				HSM2838-TR	G2070108		1-	d3
D 6404	DIODE				MA152WK-(TX)	G2070818		14-	d3
D 6405	DIODE				HSM2838-TR	G2070108		1-	d3
D 6405	DIODE				MA152WK-(TX)	G2070818		14-	d3
D 6406	DIODE				HSM2838-TR	G2070108		1-	d1
D 6406	DIODE				MA152WK-(TX)	G2070818		14-	d1

TUNER-MAIN Unit

Parts List

REF.	DESCRIPTION	VALUE	V/W	TOL.	MFR'S DESIG	YAESU P/N	VERS.	LOT.	LAY ADR
D 6407	DIODE				HSM2838-TR	G2070108		1-	d1
D 6407	DIODE				MA152WK-(TX)	G2070818		14-	d1
D 6408	DIODE				HSM2838-TR	G2070108		1-	d1
D 6408	DIODE				MA152WK-(TX)	G2070818		14-	d1
D 6409	DIODE				HSM2838-TR	G2070108		1-	d1
D 6409	DIODE				MA152WK-(TX)	G2070818		14-	d1
D 6450	DIODE				BAS316	G2070716		1-	a4
D 6451	DIODE				BAS316	G2070716		1-	a1
D 6452	DIODE				U15J	G2090572		1-	G2
D 6453	DIODE				BAS316	G2070716		1-	a4
D 6454	DIODE				BAS316	G2070716		1-	a2
D 6455	DIODE				BAS316	G2070716		1-	a2
D 6456	SURGEABSORBER				DSP201M-S00B	Q9000375		1-	G4
J 6401	CONNECTOR				TMP-J01X-A2	P1090255		1-	
J 6450	CONNECTOR				TMP-J01X-V6	P1090210		1-	
J 6451	CONNECTOR				TMP-J01X-V6	P1090210		1-	
J 6452	CONNECTOR				S-Q3063#01	P1090295		1-	
J 6454	CONNECTOR				TMP-J01X-A2	P1090255		1-	
J 6460	CONNECTOR				MDR-2	P1090984		1-	
J 6461	CONNECTOR				MDR-2	P1090984		1-	
JP6401	WIREASSY				A0243	T9206154		1-	
JP6402	WIREASSY				A0243	T9206153		1-	
JP6403	WIREASSY				WHT 100 TMP/*	T9318150		1-	
JP6453	WIREASSY				AH006H	T9206879C		19-	
JP6453	WIREASSY				AH006H	T9206879B		1-	
JP6454	WIREASSY				RED 110 <5>/<5>	T55211021		1-	
JP6454	WIRE-ASSY				VIO100 (3)/(3)	T9318122		9-	
L 6401	COILA1				2.5T15D2.0PVF R	L0021949		1-	
L 6402	COILA1				2.5T15D2.0PVF R	L0021949		1-	
L 6403	COILA1				4.5T15D2.0PVF R	L0021950		1-	
L 6404	COILA1				6.5T19D2.0PVF R	L0022064		1-	
L 6405	COILA1				9.5T19D2.0PVF R	L0021952		1-	
L 6406	COILA1				9.5T30D2.0PVF R	L0021953		1-	
L 6407	TOROIDAL COIL	2.55uH			2.55U T106-2	L0022680		1-	
L 6408	TOROIDAL COIL	2.55uH			2.55U T106-2	L0022680		1-	
L 6409	M.RFC	22uH			LAL03TA220K	L1790099		1-	
L 6410	M.RFC	22uH			LAL03TA220K	L1790099		1-	
L 6450	M.RFC	22uH			LAL04NA220K	L1190327		1-	
L 6451	M.RFC	470uH			RCH110-471K	L1190407		1-	
L 6452	M.RFC	470uH			RCH110-471K	L1190407		1-	
L 6453	M.RFC	470uH			RCH110-471K	L1190407		1-	
L 6454	M.RFC	470uH			RCH110-471K	L1190407		1-	
L 6455	TOROIDAL COIL	0.24uH			0.240U T25-6	L0020898		1-	
Q 6401	TRANSISTOR				2SC4047-TA	G3340477		1-	d2
Q 6401	TRANSISTOR				UN2214-(TX)	G3070206		8-	d2
Q 6402	TRANSISTOR				2SC4047-TA	G3340477		1-	d2
Q 6402	TRANSISTOR				UN2214-(TX)	G3070206		8-	d2
Q 6403	TRANSISTOR				2SC4047-TA	G3340477		1-	d2
Q 6403	TRANSISTOR				UN2214-(TX)	G3070206		8-	d2
Q 6404	TRANSISTOR				2SC4047-TA	G3340477		1-	d2
Q 6404	TRANSISTOR				UN2214-(TX)	G3070206		8-	d2
Q 6405	TRANSISTOR				2SC4047-TA	G3340477		1-	d2
Q 6405	TRANSISTOR				UN2214-(TX)	G3070206		8-	d2
Q 6406	TRANSISTOR				2SC4047-TA	G3340477		1-	d2
Q 6406	TRANSISTOR				UN2214-(TX)	G3070206		8-	d2
Q 6407	TRANSISTOR				2SC4047-TA	G3340477		1-	d2
Q 6407	TRANSISTOR				UN2214-(TX)	G3070206		8-	d2
Q 6408	TRANSISTOR				2SC4047-TA	G3340477		1-	d1
Q 6408	TRANSISTOR				UN2214-(TX)	G3070206		8-	d1
Q 6409	TRANSISTOR				2SC4047-TA	G3340477		1-	d1
Q 6409	TRANSISTOR				UN2214-(TX)	G3070206		8-	d1
Q 6410	TRANSISTOR				2SC4047-TA	G3340477		1-	d1
Q 6410	TRANSISTOR				UN2214-(TX)	G3070206		8-	d1
Q 6411	TRANSISTOR				2SC4047-TA	G3340477		1-	d1
Q 6411	TRANSISTOR				UN2214-(TX)	G3070206		8-	d1
Q 6412	TRANSISTOR				2SC4047-TA	G3340477		1-	d1
Q 6412	TRANSISTOR				UN2214-(TX)	G3070206		8-	d1
Q 6413	TRANSISTOR				2SC4047-TA	G3340477		1-	d1

TUNER-MAIN Unit

Parts List

REF.	DESCRIPTION	VALUE	V/W	TOL.	MFR'S DESIG	YAESU P/N	VERS.	LOT.	LAY ADR
Q 6413	TRANSISTOR				UN2214-(TX)	G3070206		8-	d1
Q 6414	TRANSISTOR				2SC4047-TA	G3340477		1-	d1
Q 6414	TRANSISTOR				UN2214-(TX)	G3070206		8-	d1
Q 6450	TRANSISTOR				2SA684R	G3106840R		1-	F4
Q 6451	TRANSISTOR				2SD667D TZ	G3406674D		1-	F3
Q 6452	TRANSISTOR				2SC4047-TA	G3340477		1-	a2
Q 6452	TRANSISTOR				UN2214-(TX)	G3070206		8-	a2
Q 6453	TRANSISTOR				2SA1563-TB	G3115638		1-	a3
R 6401	CHIPRES.	47	1/2W	5%	RMC1/2470JCTP	J24275470		1-	
R 6402	CHIPRES.	47	1/2W	5%	RMC1/2470JCTP	J24275470		1-	
R 6403	CHIPRES.	47	1/2W	5%	RMC1/2470JCTP	J24275470		1-	
R 6404	CHIPRES.	47	1/2W	5%	RMC1/2470JCTP	J24275470		1-	
R 6405	CHIPRES.	47	1/2W	5%	RMC1/2470JCTP	J24275470		1-	
R 6406	CHIPRES.	47	1/2W	5%	RMC1/2470JCTP	J24275470		1-	
R 6407	CHIPRES.	47	1/2W	5%	RMC1/2470JCTP	J24275470		1-	
R 6408	CHIPRES.	47	1/2W	5%	RMC1/2470JCTP	J24275470		1-	
R 6409	CHIPRES.	47	1/2W	5%	RMC1/2470JCTP	J24275470		1-	
R 6410	CHIPRES.	47	1/2W	5%	RMC1/2470JCTP	J24275470		1-	
R 6411	CHIPRES.	47	1/2W	5%	RMC1/2470JCTP	J24275470		1-	
R 6412	CHIPRES.	47	1/2W	5%	RMC1/2470JCTP	J24275470		1-	
R 6413	CHIPRES.	47	1/2W	5%	RMC1/2470JCTP	J24275470		1-	
R 6414	CHIPRES.	47	1/2W	5%	RMC1/2470JCTP	J24275470		1-	
R 6450	CHIPRES.	2.2k	1/10W	5%	RMC1/10T 222J	J24205222		1-	
R 6452	CHIPRES.	2.2k	1/10W	5%	RMC1/10T 222J	J24205222		1-	
R 6453	METAL FILM RES.	82	3W	5%	ERG-3SJ820 82	J22355820		1-	
R 6454	CHIPRES.	4.7k	1/10W	5%	RMC1/10T 472J	J24205472		1-	
R 6455	CHIPRES.	2.2k	1/10W	5%	RMC1/10T 222J	J24205222		1-	
R 6457	CHIPRES.	4.7k	1/10W	5%	RMC1/10T 472J	J24205472		1-	
R 6458	CHIPRES.	2.2k	1/10W	5%	RMC1/10T 222J	J24205222		1-	
RL6401	RELAY		DC12V		AGP2003 DC12V	M1190075		1-	
RL6402	RELAY		DC12V		AGP2003 DC12V	M1190075		1-	
RL6403	RELAY		DC12V		AGP2003 DC12V	M1190075		1-	
RL6404	RELAY		DC12V		AGP2003 DC12V	M1190075		1-	
RL6405	RELAY		DC12V		AGP2003 DC12V	M1190075		1-	
RL6406	RELAY		DC12V		AGP2003 DC12V	M1190075		1-	
RL6407	RELAY		DC12V		AGP2003 DC12V	M1190075		1-	
RL6408	RELAY		DC12V		AGP2003 DC12V	M1190075		1-	
RL6409	RELAY		DC12V		AGP2003 DC12V	M1190075		1-	
RL6410	RELAY		DC12V		AGP2003 DC12V	M1190075		1-	
RL6411	RELAY		DC12V		AGP2003 DC12V	M1190075		1-	
RL6412	RELAY		DC12V		AGP2003 DC12V	M1190075		1-	
RL6413	RELAY		DC12V		AGP2003 DC12V	M1190075		1-	
RL6414	RELAY		DC12V		AGP2003 DC12V	M1190075		1-	
RL6450	RELAY		DC12V		FBR321D012 DC12V	M1190023		1-	
RL6451	RELAY		DC12V		TC-112NV DC12V	M1190104		1-	
RL6452	RELAY		DC12V		AGP2013 DC12V	M1190069		1-	
RL6453	RELAY		DC12V		AGP2013 DC12V	M1190069		1-	
VC6401	VARIABLE CAP.	125pF			YV-125-05	K90000049		1-	
VC6402	VARIABLE CAP.	125pF			YV-125-05	K90000049		1-	
	SPONGERUBBER					RA0279200		9-	
	SPONGERUBBER					RA0279200		9-	

TUNER-MAIN Unit

Note

TUNER-CNTL Unit

Parts Layout

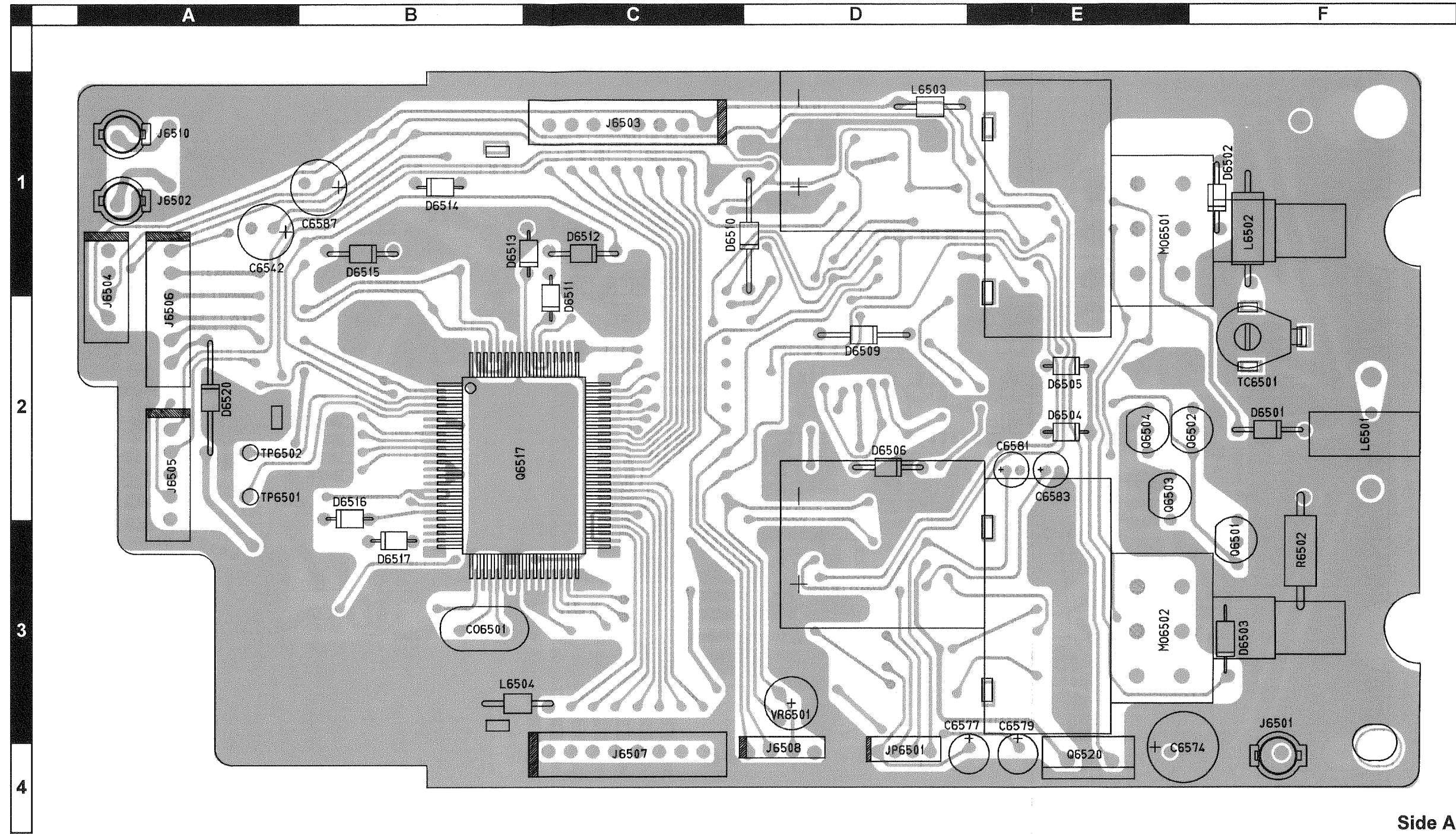

Side A

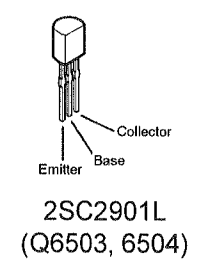
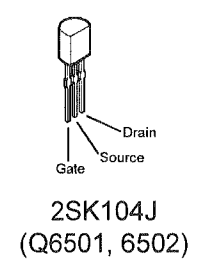
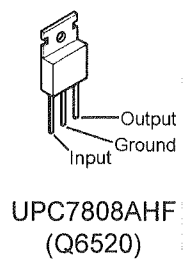
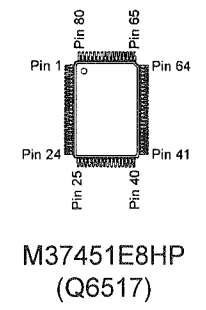

TUNER-CNTL Unit

Parts Layout

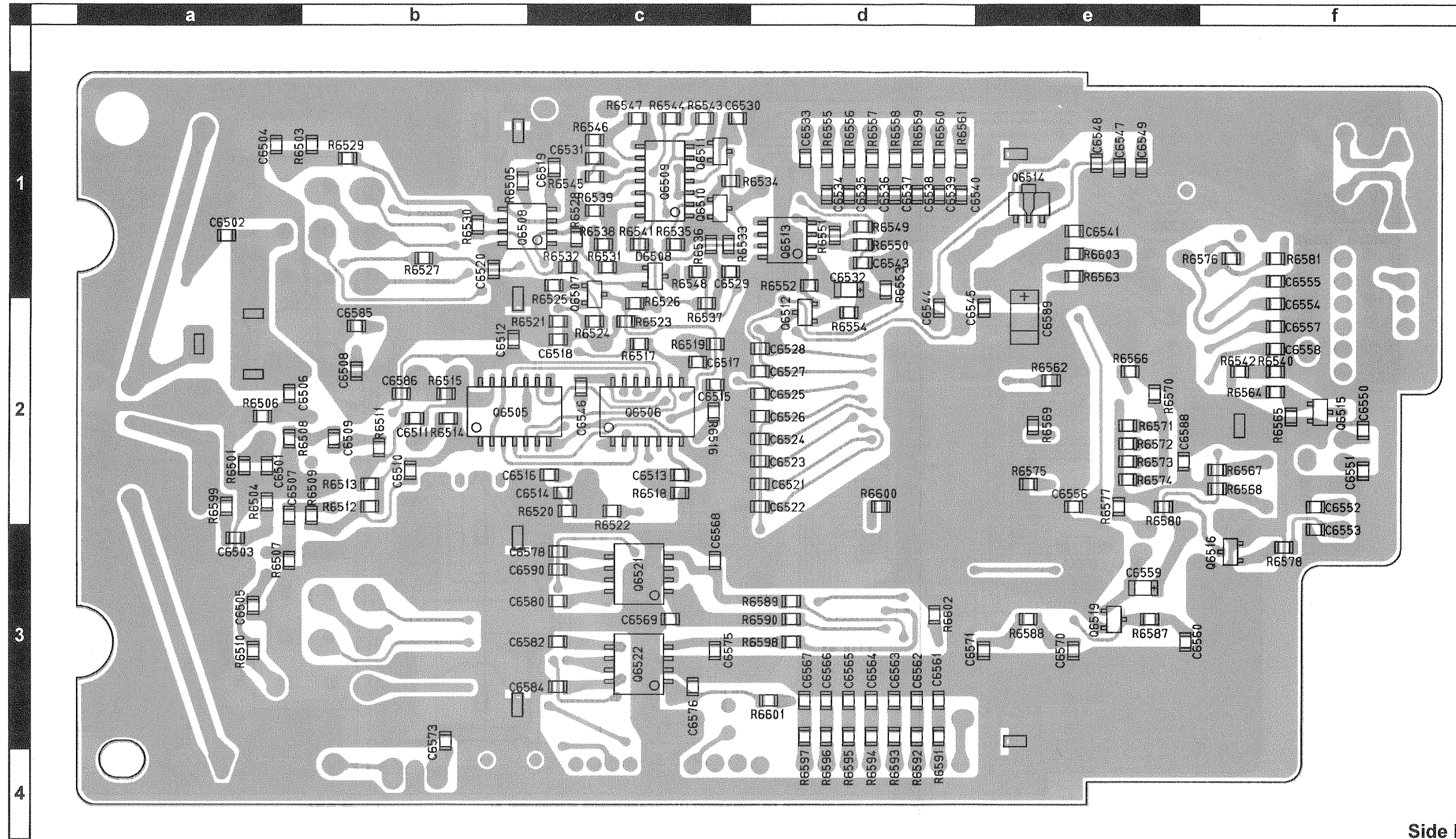

Side B

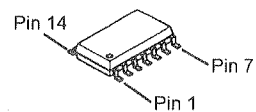

HD74AC00FP-TR
(Q6505)

HD74AC74FP-TR
(Q6506)

NJM2902M(Te1)
(Q6509)

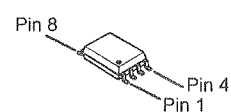

MB3763PF
(Q6521, 6522)

NJM2903M(Te1)
(Q6513)

NJM2904M(Te2)
(Q6508)

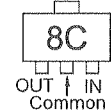

NJM78L05UA (8C)
(Q6514)

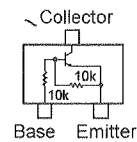

UN2211 (8A)
(Q6516)

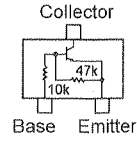

UN2214 (TX)
(Q6519)

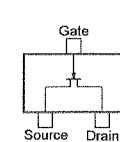

2SK160 (K6)
(Q6510, 6511)

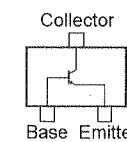

2SA1235 (ME)
(Q6512)

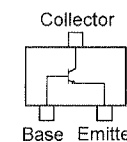

2SC2712GR (LG)
(Q6507, 6515)

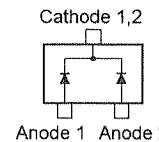

HSM2838-TR (A6)
(D6508)

REF.	DESCRIPTION	VALUE	V/W	TOL.	MFR'S DESIG	YAESU P/N	VERS.	LOT.	LAYADR
PCB with Components						CB1199001			
Printed Circuit Board						F3247000B			1-
C 6501	CHIP CAP.	0.01uF	50V	B	GRM40B103M50PT	K22170817			1-
C 6502	CHIP CAP.	220pF	50V	CH	GRM40CH221J50PT	K22170243			1-
C 6503	CHIP CAP.	0.01uF	50V	B	GRM40B103M50PT	K22170817			1-
C 6504	CHIP CAP.	0.01uF	50V	B	GRM40B103M50PT	K22170817			1-
C 6505	CHIP CAP.	0.01uF	50V	B	GRM40B103M50PT	K22170817			1-
C 6506	CHIP CAP.	0.01uF	50V	B	GRM40B103M50PT	K22170817			1-
C 6507	CHIP CAP.	0.01uF	50V	B	GRM40B103M50PT	K22170817			1-
C 6508	CHIP CAP.	0.047uF	50V	F	GRM40F473Z50PT	K22171008			1-
C 6509	CHIP CAP.	0.01uF	50V	B	GRM40B103M50PT	K22170817			1-
C 6510	CHIP CAP.	0.01uF	50V	B	GRM40B103M50PT	K22170817			1-
C 6511	CHIP CAP.	0.01uF	50V	B	GRM40B103M50PT	K22170817			1-
C 6512	CHIP CAP.	0.01uF	50V	B	GRM40B103M50PT	K22170817			1-
C 6513	CHIP CAP.	0.047uF	50V	F	GRM40F473Z50PT	K22171008			1-
C 6514	CHIP CAP.	0.01uF	50V	B	GRM40B103M50PT	K22170817			1-
C 6515	CHIP CAP.	0.01uF	50V	B	GRM40B103M50PT	K22170817			1-
C 6516	CHIP CAP.	0.01uF	50V	B	GRM40B103M50PT	K22170817			1-
C 6517	CHIP CAP.	0.047uF	50V	F	GRM40F473Z50PT	K22171008			1-
C 6518	CHIP CAP.	0.01uF	50V	B	GRM40B103M50PT	K22170817			1-
C 6519	CHIP CAP.	0.1uF	25V	B	GRM40B104M25PT	K22140811			1-
C 6520	CHIP CAP.	0.01uF	50V	B	GRM40B103M50PT	K22170817			1-
C 6521	CHIP CAP.	0.01uF	50V	B	GRM40B103M50PT	K22170817			1-
C 6522	CHIP CAP.	0.01uF	50V	B	GRM40B103M50PT	K22170817			1-
C 6523	CHIP CAP.	0.01uF	50V	B	GRM40B103M50PT	K22170817			1-
C 6524	CHIP CAP.	0.01uF	50V	B	GRM40B103M50PT	K22170817			1-
C 6525	CHIP CAP.	0.01uF	50V	B	GRM40B103M50PT	K22170817			1-
C 6526	CHIP CAP.	0.01uF	50V	B	GRM40B103M50PT	K22170817			1-
C 6527	CHIP CAP.	0.01uF	50V	B	GRM40B103M50PT	K22170817			1-
C 6528	CHIP CAP.	0.047uF	50V	F	GRM40F473Z50PT	K22171008			1-
C 6529	CHIP CAP.	0.047uF	50V	F	GRM40F473Z50PT	K22171008			1-
C 6530	CHIP CAP.	0.01uF	50V	B	GRM40B103M50PT	K22170817			1-
C 6531	CHIP CAP.	0.047uF	50V	F	GRM40F473Z50PT	K22171008			1-
C 6532	CHIP TA.CAP.	1uF	16V		TESVA1C105M1-8R	K78120009			1-
C 6533	CHIP CAP.	0.01uF	50V	B	GRM40B103M50PT	K22170817			1-
C 6534	CHIP CAP.	0.01uF	50V	B	GRM40B103M50PT	K22170817			1-
C 6535	CHIP CAP.	0.01uF	50V	B	GRM40B103M50PT	K22170817			1-
C 6536	CHIP CAP.	0.01uF	50V	B	GRM40B103M50PT	K22170817			1-
C 6537	CHIP CAP.	0.01uF	50V	B	GRM40B103M50PT	K22170817			1-
C 6538	CHIP CAP.	0.01uF	50V	B	GRM40B103M50PT	K22170817			1-
C 6539	CHIP CAP.	0.01uF	50V	B	GRM40B103M50PT	K22170817			1-
C 6540	CHIP CAP.	0.01uF	50V	B	GRM40B103M50PT	K22170817			1-
C 6541	CHIP CAP.	0.01uF	50V	B	GRM40B103M50PT	K22170817			1-
C 6542	AL.ELECTRO.CAP.	100uF	10V		RC2-10V101M(6X7)	K40109015			1-
C 6543	CHIP CAP.	0.047uF	50V	F	GRM40F473Z50PT	K22171008			1-
C 6544	CHIP CAP.	0.01uF	50V	B	GRM40B103M50PT	K22170817			1-
C 6545	CHIP CAP.	0.047uF	50V	F	GRM40F473Z50PT	K22171008			1-
C 6546	CHIP CAP.	0.01uF	50V	B	GRM40B103M50PT	K22170817			1-
C 6547	CHIP CAP.	0.1uF	25V	B	GRM40B104M25PT	K22140811			1-
C 6548	CHIP CAP.	0.1uF	25V	B	GRM40B104M25PT	K22140811			1-
C 6549	CHIP CAP.	0.1uF	25V	B	GRM40B104M25PT	K22140811			1-
C 6550	CHIP CAP.	0.01uF	50V	B	GRM40B103M50PT	K22170817			1-
C 6551	CHIP CAP.	0.01uF	50V	B	GRM40B103M50PT	K22170817			1-
C 6552	CHIP CAP.	0.01uF	50V	B	GRM40B103M50PT	K22170817			1-
C 6553	CHIP CAP.	0.01uF	50V	B	GRM40B103M50PT	K22170817			1-
C 6554	CHIP CAP.	0.01uF	50V	B	GRM40B103M50PT	K22170817			1-
C 6555	CHIP CAP.	0.01uF	50V	B	GRM40B103M50PT	K22170817			1-
C 6556	CHIP CAP.	0.0022uF	50V	B	GRM40B222M50PT	K22170809			1-
C 6557	CHIP CAP.	0.01uF	50V	B	GRM40B103M50PT	K22170817			1-
C 6558	CHIP CAP.	0.01uF	50V	B	GRM40B103M50PT	K22170817			1-
C 6559	CHIP TA.CAP.	0.47uF	25V		TESVA1E474M1-8R	K78140009			1-
C 6560	CHIP CAP.	0.01uF	50V	B	GRM40B103M50PT	K22170817			1-
C 6561	CHIP CAP.	0.01uF	50V	B	GRM40B103M50PT	K22170817			1-
C 6562	CHIP CAP.	0.01uF	50V	B	GRM40B103M50PT	K22170817			1-
C 6563	CHIP CAP.	0.01uF	50V	B	GRM40B103M50PT	K22170817			1-
C 6564	CHIP CAP.	0.01uF	50V	B	GRM40B103M50PT	K22170817			1-
C 6565	CHIP CAP.	0.01uF	50V	B	GRM40B103M50PT	K22170817			1-
C 6566	CHIP CAP.	0.01uF	50V	B	GRM40B103M50PT	K22170817			1-

TUNER-CNTL Unit

Parts List

REF.	DESCRIPTION	VALUE	V/W	TOL.	MFR'S DESIG	YAESU P/N	VERS.	LOT.	LAY ADR
C 6567	CHIP CAP.	0.01uF	50V	B	GRM40B103M50PT	K22170817		1-	
C 6568	CHIP CAP.	0.01uF	50V	B	GRM40B103M50PT	K22170817		1-	
C 6569	CHIP CAP.	0.01uF	50V	B	GRM40B103M50PT	K22170817		1-	
C 6570	CHIP CAP.	33pF	50V	RH	GRM40RH330J50PT	K22170523		1-	
C 6571	CHIP CAP.	33pF	50V	RH	GRM40RH330J50PT	K22170523		1-	
C 6573	CHIP CAP.	0.047uF	50V	F	GRM40F473Z50PT	K22171008		1-	
C 6574	AL.ELECTRO.CAP.	330uF	16V		RE2-16V331M 330UF	K40129043		1-	
C 6575	CHIP CAP.	0.01uF	50V	B	GRM40B103M50PT	K22170817		1-	
C 6576	CHIP CAP.	0.01uF	50V	B	GRM40B103M50PT	K22170817		1-	
C 6577	AL.ELECTRO.CAP.	10uF	50V		RE2-50V100M 10UF	K40179041		1-	
C 6578	CHIP CAP.	0.047uF	50V	F	GRM40F473Z50PT	K22171008		1-	
C 6579	AL.ELECTRO.CAP.	10uF	50V		RE2-50V100M 10UF	K40179041		1-	
C 6580	CHIP CAP.	0.047uF	50V	F	GRM40F473Z50PT	K22171008		1-	
C 6581	AL.ELECTRO.CAP.	10uF	16V		RC2-16V100M(4X7)	K40129012		1-	
C 6582	CHIP CAP.	0.047uF	50V	F	GRM40F473Z50PT	K22171008		1-	
C 6583	AL.ELECTRO.CAP.	10uF	16V		RC2-16V100M(4X7)	K40129012		1-	
C 6584	CHIP CAP.	0.047uF	50V	F	GRM40F473Z50PT	K22171008		1-	
C 6585	CHIP CAP.	0.047uF	50V	F	GRM40F473Z50PT	K22171008		1-	
C 6586	CHIP CAP.	0.01uF	50V	B	GRM40B103M50PT	K22170817		1-	
C 6587	AL.ELECTRO.CAP.	100uF	10V		RC2-10V101M(6X7)	K40109015		1-	
C 6588	CHIP CAP.	0.01uF	50V	B	GRM40B103M50PT	K22170817		1-	
C 6589	CHIP TA.CAP.	22uF	6.3V		TESVC0J226M12R	K78080011		1-	
C 6590	CHIP CAP.	0.01uF	50V	B	GRM40B103M50PT	K22170817		1-	
CO6501	CERAMIC OSC				CSA8.00MT	H7900580		1-	
D 6501	DIODE				1SS101	G2090223		1-	F2
D 6502	DIODE				1SS101	G2090223		1-	F1
D 6503	DIODE				RD4.7EB2-T1	G2060006		1-	F3
D 6504	DIODE				1SS270TJ	G2060004		1-	E2
D 6504	DIODE				1SS133 T-77	G2060001		27-	E2
D 6505	DIODE				1SS270TJ	G2060004		1-	E2
D 6505	DIODE				1SS133 T-77	G2060001		27-	E2
D 6506	DIODE				1SS97	G2090118		1-	D2
D 6506	DIODE				MA700A	G2090642		5-	D2
D 6508	DIODE				HSM2838-TR	G2070108		1-	c1
D 6508	DIODE				MA152WK-(TX)	G2070818		14-	c1
D 6509	DIODE				1SS97	G2090118		1-	D2
D 6509	DIODE				MA700A	G2090642		5-	D2
D 6510	DIODE				1SS270TJ	G2060004		1-	D2
D 6510	DIODE				1SS133 T-77	G2060001		27-	D2
D 6511	DIODE				1SS270TJ	G2060004		1-	C1
D 6511	DIODE				1SS133 T-77	G2060001		27-	C1
D 6512	DIODE				1SS270TJ	G2060004		1-	C1
D 6512	DIODE				1SS133 T-77	G2060001		27-	C1
D 6513	DIODE				1SS270TJ	G2060004		1-	C1
D 6513	DIODE				1SS133 T-77	G2060001		27-	C1
D 6514	DIODE				1SS270TJ	G2060004		1-	B1
D 6514	DIODE				1SS133 T-77	G2060001		27-	B1
D 6515	DIODE				1SS97	G2090118		1-	B1
D 6515	DIODE				MA700A	G2090642		5-	B1
D 6516	DIODE				1SS270TJ	G2060004		1-	B2
D 6516	DIODE				1SS133 T-77	G2060001		27-	B2
D 6517	DIODE				1SS270TJ	G2060004		1-	B3
D 6517	DIODE				1SS133 T-77	G2060001		27-	B3
D 6520	DIODE				1SS270TJ	G2060004		1-	A2
D 6520	DIODE				1SS133 T-77	G2060001		27-	A2
J 6501	CONNECTOR				TMP-J01X-V6	P1090210		1-	
J 6503	CONNECTOR				SC25-08WS	P0090627		1-	
J 6507	CONNECTOR				SC25-08WL	P0090715		1-	
J 6508	CONNECTOR				IMSA-1068-04L	P0090316		1-	
JP6501	WIRE ASSY				A0243	T9206156A		1-	
JP6502	WIRE ASSY				WHT 230 TMP/*	T9318153		1-	
JP6504	WIRE ASSY				AH006H	T9206887		1-	
JP6504	WIRE ASSY				AH006H	T9206922		12-	
JP6505	WIRE ASSY				AH006H	T9206890A		1-	
JP6506	WIRE ASSY				AH006H	T9206878A		1-	
L 6501	TOROIDAL COIL	720uH			U 2001F FR9.5	L0021955		1-	
L 6502	M.RFC	1mH			LAL04NA102K	L1190090		1-	
L 6503	M.RFC	100uH			LAL03TA101K	L1790107		1-	

TUNER-CNTL Unit

Parts List

REF.	DESCRIPTION	VALUE	V/W	TOL.	MFR'S DESIG	YAESU P/N	VERS.	LOT.	LAY ADR
L 6504	M.RFC	100uH			LAL03TA101K	L1790107		1-	
MO6501	MOTOR POT.				RK16312MA 50KB	Q9000563		1-	
MO6502	MOTOR POT.				RK16312MA 50KB	Q9000563		1-	
Q 6501	FET				2SK104J	G3801040J		1-	F3
Q 6502	FET				2SK104J	G3801040J		1-	E2
Q 6503	TRANSISTOR				2SC2901L	G3329010L		1-	E2
Q 6504	TRANSISTOR				2SC2901L	G3329010L		1-	E2
Q 6505	IC				HD74AC00FP-TR	G1091226		1-	b2
Q 6506	IC				HD74AC74FP-TR	G1091225		1-	c2
Q 6507	TRANSISTOR				2SC2712GR TE85R	G3327127G		1-	c1
Q 6508	IC				NJM2904M(TE2)	G1093091		1-	b2
Q 6509	IC				NJM2902M(TE1)	G1093092		1-	c1
Q 6510	FET				2SK160-T2B K5	G3801607E		1-	c1
Q 6511	FET				2SK160-T2B K5	G3801607E		1-	c1
Q 6512	TRANSISTOR				2SA1235-T12-2E	G3112357E		1-	d2
Q 6513	IC				NJM2903M(TE1)	G1093090		1-	d1
Q 6514	IC				NJM78L05UA TE1	G1091325		1-	e1
Q 6515	TRANSISTOR				2SC2712GR TE85R	G3327127G		1-	f2
Q 6516	TRANSISTOR				UN2211-(TX)	G3070205		1-	f3
Q 6517	IC				M37451E8HP R0309	G1093129		1-	B2
Q 6517	IC				M37451M8-733HP	G1093351		11-	B2
Q 6519	TRANSISTOR				UN2214-(TX)	G3070206		1-	e3
Q 6520	IC				UPC7808AHF	G1092258		1-	E4
Q 6520	IC				AN7808F	G1092581		6-	E4
Q 6521	IC				MB3763PF-G-BND-TF	G1091224		1-	c2
Q 6522	IC				MB3763PF-G-BND-TF	G1091224		1-	c2
R 6501	CHIP RES.	10k	1/10W	5%	RMC1/10T 103J	J24205103		1-	
R 6502	CARBON FILM RES.	24	1/2W	5%	RD12TJ240 24	J01275240		1-	
R 6503	CHIP RES.	10k	1/10W	5%	RMC1/10T 103J	J24205103		1-	
R 6504	CHIP RES.	100k	1/10W	5%	RMC1/10T 104J	J24205104		1-	
R 6505	CHIP RES.	47	1/10W	5%	RMC1/10T 470J	J24205470		1-	
R 6506	CHIP RES.	100k	1/10W	5%	RMC1/10T 104J	J24205104		1-	
R 6507	CHIP RES.	1.5k	1/10W	5%	RMC1/10T 152J	J24205152		1-	
R 6508	CHIP RES.	1.5k	1/10W	5%	RMC1/10T 152J	J24205152		1-	
R 6509	CHIP RES.	33k	1/10W	5%	RMC1/10T 333J	J24205333		1-	
R 6510	CHIP RES.	1k	1/10W	5%	RMC1/10T 102J	J24205102		1-	
R 6511	CHIP RES.	33k	1/10W	5%	RMC1/10T 333J	J24205333		1-	
R 6512	CHIP RES.	1.5k	1/10W	5%	RMC1/10T 152J	J24205152		1-	
R 6513	CHIP RES.	1.5k	1/10W	5%	RMC1/10T 152J	J24205152		1-	
R 6514	CHIP RES.	100k	1/10W	5%	RMC1/10T 104J	J24205104		1-	
R 6515	CHIP RES.	100k	1/10W	5%	RMC1/10T 104J	J24205104		1-	
R 6516	CHIP RES.	47k	1/10W	5%	RMC1/10T 473J	J24205473		1-	
R 6517	CHIP RES.	47k	1/10W	5%	RMC1/10T 473J	J24205473		1-	
R 6518	CHIP RES.	1k	1/10W	5%	RMC1/10T 102J	J24205102		1-	
R 6519	CHIP RES.	1k	1/10W	5%	RMC1/10T 102J	J24205102		1-	
R 6520	CHIP RES.	100k	1/10W	5%	RMC1/10T 104J	J24205104		1-	
R 6521	CHIP RES.	100k	1/10W	5%	RMC1/10T 104J	J24205104		1-	
R 6522	CHIP RES.	1k	1/10W	5%	RMC1/10T 102J	J24205102		1-	
R 6523	CHIP RES.	1k	1/10W	5%	RMC1/10T 102J	J24205102		1-	
R 6524	CHIP RES.	10k	1/10W	5%	RMC1/10T 103J	J24205103		1-	
R 6525	CHIP RES.	10k	1/10W	5%	RMC1/10T 103J	J24205103		1-	
R 6526	CHIP RES.	10k	1/10W	5%	RMC1/10T 103J	J24205103		1-	
R 6527	CHIP RES.	100k	1/10W	1%	RMC1/10 1003FTP	J24209009		1-	
R 6528	CHIP RES.	220k	1/10W	1%	RMC1/10 2203FTP	J24209041		1-	
R 6529	CHIP RES.	100k	1/10W	1%	RMC1/10 1003FTP	J24209009		1-	
R 6530	CHIP RES.	220k	1/10W	1%	RMC1/10 2203FTP	J24209041		1-	
R 6531	CHIP RES.	1k	1/10W	5%	RMC1/10T 102J	J24205102		1-	
R 6532	CHIP RES.	1k	1/10W	5%	RMC1/10T 102J	J24205102		1-	
R 6533	CHIP RES.	100k	1/10W	5%	RMC1/10T 104J	J24205104		1-	
R 6534	CHIP RES.	1M	1/10W	5%	RMC1/10T 105J	J24205105		1-	
R 6535	CHIP RES.	220k	1/10W	5%	RMC1/10T 224J	J24205224		1-	
R 6536	CHIP RES.	100k	1/10W	5%	RMC1/10T 104J	J24205104		1-	
R 6537	CHIP RES.	10k	1/10W	5%	RMC1/10T 103J	J24205103		1-	
R 6538	CHIP RES.	47k	1/10W	5%	RMC1/10T 473J	J24205473		1-	
R 6539	CHIP RES.	4.7k	1/10W	5%	RMC1/10T 472J	J24205472		1-	
R 6540	CHIP RES.	2.2M	1/10W	5%	RMC1/10T 225J	J24205225		1-	
R 6541	CHIP RES.	47k	1/10W	5%	RMC1/10T 473J	J24205473		1-	
R 6542	CHIP RES.	1M	1/10W	5%	RMC1/10T 105J	J24205105		1-	

TUNER-CNTL Unit

Parts List

REF.	DESCRIPTION	VALUE	V/W	TOL.	MFR'S DESIG	YAESU P/N	VERS.	LOT.	LAYADR
R 6543	CHIP RES.	220k	1/10W	5%	RMC1/10T 224J	J24205224		1-	
R 6544	CHIP RES.	100k	1/10W	5%	RMC1/10T 104J	J24205104		1-	
R 6545	CHIP RES.	10k	1/10W	5%	RMC1/10T 103J	J24205103		1-	
R 6546	CHIP RES.	4.7k	1/10W	5%	RMC1/10T 472J	J24205472		1-	
R 6547	CHIP RES.	47k	1/10W	5%	RMC1/10T 473J	J24205473		1-	
R 6548	CHIP RES.	10k	1/10W	5%	RMC1/10T 103J	J24205103		1-	
R 6549	CHIP RES.	2.2M	1/10W	5%	RMC1/10T 225J	J24205225		1-	
R 6550	CHIP RES.	10k	1/10W	5%	RMC1/10T 103J	J24205103		1-	
R 6551	CHIP RES.	33k	1/10W	5%	RMC1/10T 333J	J24205333		1-	
R 6552	CHIP RES.	10k	1/10W	5%	RMC1/10T 103J	J24205103		1-	
R 6553	CHIP RES.	22k	1/10W	5%	RMC1/10T 223J	J24205223		1-	
R 6554	CHIP RES.	10k	1/10W	5%	RMC1/10T 103J	J24205103		1-	
R 6555	CHIP RES.	1k	1/10W	5%	RMC1/10T 102J	J24205102		1-	
R 6556	CHIP RES.	1k	1/10W	5%	RMC1/10T 102J	J24205102		1-	
R 6557	CHIP RES.	1k	1/10W	5%	RMC1/10T 102J	J24205102		1-	
R 6558	CHIP RES.	1k	1/10W	5%	RMC1/10T 102J	J24205102		1-	
R 6559	CHIP RES.	1k	1/10W	5%	RMC1/10T 102J	J24205102		1-	
R 6560	CHIP RES.	1k	1/10W	5%	RMC1/10T 102J	J24205102		1-	
R 6561	CHIP RES.	1k	1/10W	5%	RMC1/10T 102J	J24205102		1-	
R 6562	CHIP RES.	100k	1/10W	5%	RMC1/10T 104J	J24205104		1-	
R 6563	CHIP RES.	100k	1/10W	5%	RMC1/10T 104J	J24205104		1-	
R 6564	CHIP RES.	10k	1/10W	5%	RMC1/10T 103J	J24205103		1-	
R 6564	CHIP RES.	2.7k	1/10W	5%	RMC1/10T 272J	J24205272		3-	
R 6565	CHIP RES.	10k	1/10W	5%	RMC1/10T 103J	J24205103		1-	
R 6566	CHIP RES.	100k	1/10W	5%	RMC1/10T 104J	J24205104		1-	
R 6567	CHIP RES.	100k	1/10W	5%	RMC1/10T 104J	J24205104		1-	
R 6568	CHIP RES.	100k	1/10W	5%	RMC1/10T 104J	J24205104		1-	
R 6569	CHIP RES.	100k	1/10W	5%	RMC1/10T 104J	J24205104		1-	
R 6570	CHIP RES.	4.7k	1/10W	5%	RMC1/10T 472J	J24205472		1-	
R 6571	CHIP RES.	100k	1/10W	5%	RMC1/10T 104J	J24205104		1-	
R 6572	CHIP RES.	100k	1/10W	5%	RMC1/10T 104J	J24205104		1-	
R 6573	CHIP RES.	100k	1/10W	5%	RMC1/10T 104J	J24205104		1-	
R 6574	CHIP RES.	100k	1/10W	5%	RMC1/10T 104J	J24205104		1-	
R 6575	CHIP RES.	100k	1/10W	5%	RMC1/10T 104J	J24205104		1-	
R 6576	CHIP RES.	100k	1/10W	5%	RMC1/10T 104J	J24205104		1-	
R 6577	CHIP RES.	100k	1/10W	5%	RMC1/10T 104J	J24205104		1-	
R 6578	CHIP RES.	10k	1/10W	5%	RMC1/10T 103J	J24205103		1-	
R 6580	CHIP RES.	10k	1/10W	5%	RMC1/10T 103J	J24205103		1-	
R 6581	CHIP RES.	1k	1/10W	5%	RMC1/10T 102J	J24205102		1-	
R 6587	CHIP RES.	4.7k	1/10W	5%	RMC1/10T 472J	J24205472		1-	
R 6588	CHIP RES.	1M	1/10W	5%	RMC1/10T 105J	J24205105		1-	
R 6589	CHIP RES.	1k	1/10W	5%	RMC1/10T 102J	J24205102		1-	
R 6590	CHIP RES.	1k	1/10W	5%	RMC1/10T 102J	J24205102		1-	
R 6591	CHIP RES.	1k	1/10W	5%	RMC1/10T 102J	J24205102		1-	
R 6592	CHIP RES.	1k	1/10W	5%	RMC1/10T 102J	J24205102		1-	
R 6593	CHIP RES.	1k	1/10W	5%	RMC1/10T 102J	J24205102		1-	
R 6594	CHIP RES.	1k	1/10W	5%	RMC1/10T 102J	J24205102		1-	
R 6595	CHIP RES.	1k	1/10W	5%	RMC1/10T 102J	J24205102		1-	
R 6596	CHIP RES.	1k	1/10W	5%	RMC1/10T 102J	J24205102		1-	
R 6597	CHIP RES.	1k	1/10W	5%	RMC1/10T 102J	J24205102		1-	
R 6598	CHIP RES.	1k	1/10W	5%	RMC1/10T 102J	J24205102		1-	
R 6599	CHIP RES.	180	1/10W	5%	RMC1/10T 181J	J24205181		1-	
R 6600	CHIP RES.	100k	1/10W	5%	RMC1/10T 104J	J24205104		1-	
R 6601	CHIP RES.	1k	1/10W	5%	RMC1/10T 102J	J24205102		1-	
R 6602	CHIP RES.	100k	1/10W	5%	RMC1/10T 104J	J24205104		1-	
R 6603	CHIP RES.	10k	1/10W	5%	RMC1/10T 103J	J24205103		1-	
R 6604	CARBON FILM RES.	10k	1/6W	5%	RD16TPJ103 10K	J07225103		3-	
RL6501	RELAY		DC12V		AHY123 DC12V	M1190149		3-	
TC6501	TRIMMER CAP.	10pF			ECV1ZW10X32 10PF	K91000012		1-	
TP6501	TERMINAL				TP-E/MS-60124	Q5000016		1-	
TP6502	TERMINAL				TP-E/MS-60124	Q5000016		1-	
VR6501	POT.	47k			RH0411CS4J 47KB	J51827473		1-	
	HOLDER				VC	R0140880B		1-	
	SHIELD PLATE					R0516730B		1-	
	UNIVERSAL JOINT				116-4	S1000003		1-	
	MINI CLAMP				MN-2	S6000293		1-	
	NYLON CLAMP				PLT-1M BK-1	S3000022		1-	

ALC Unit Circuit Diagram

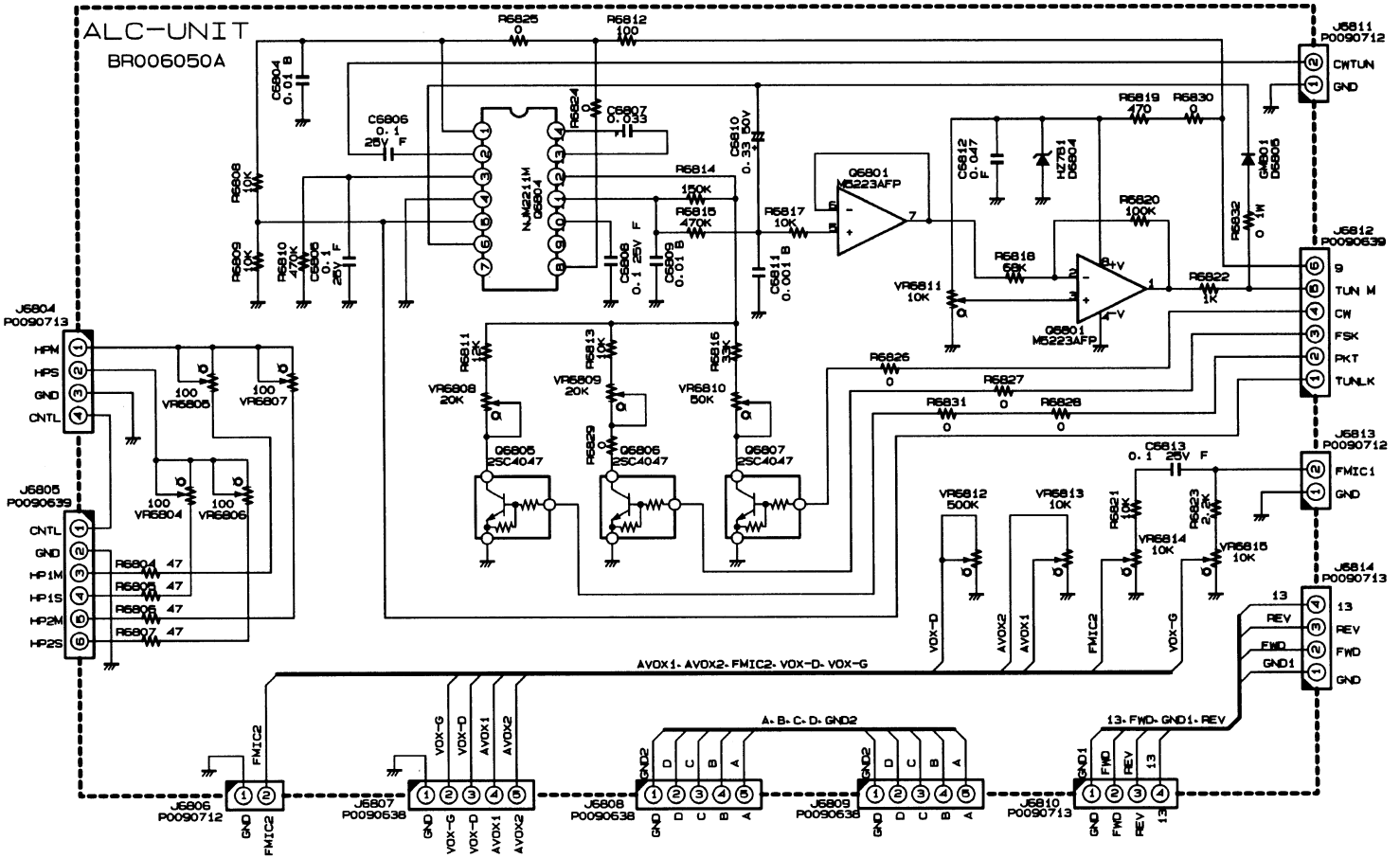

ALC Unit

Parts Layout

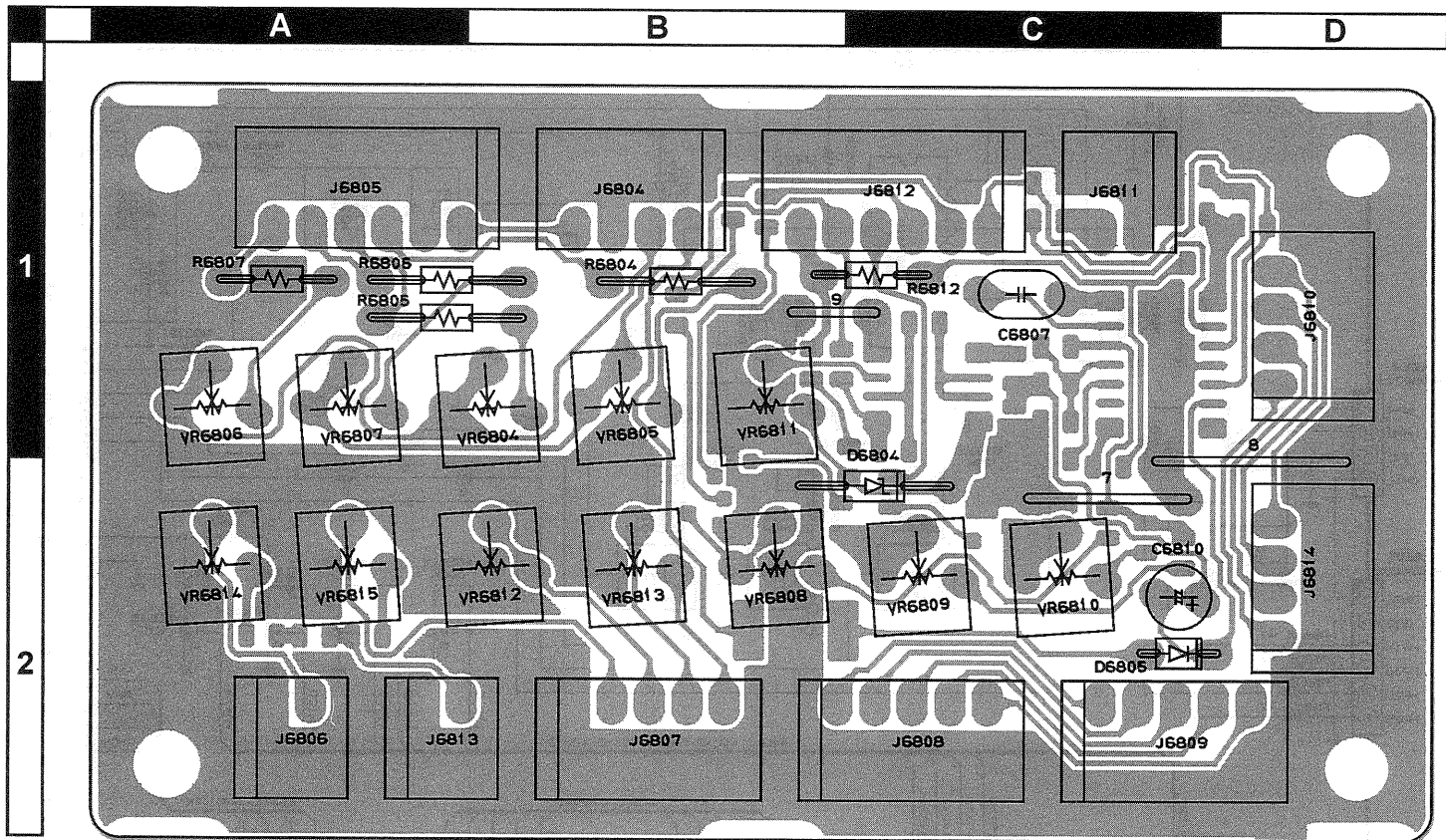

Side A

ALC Unit

Parts Layout

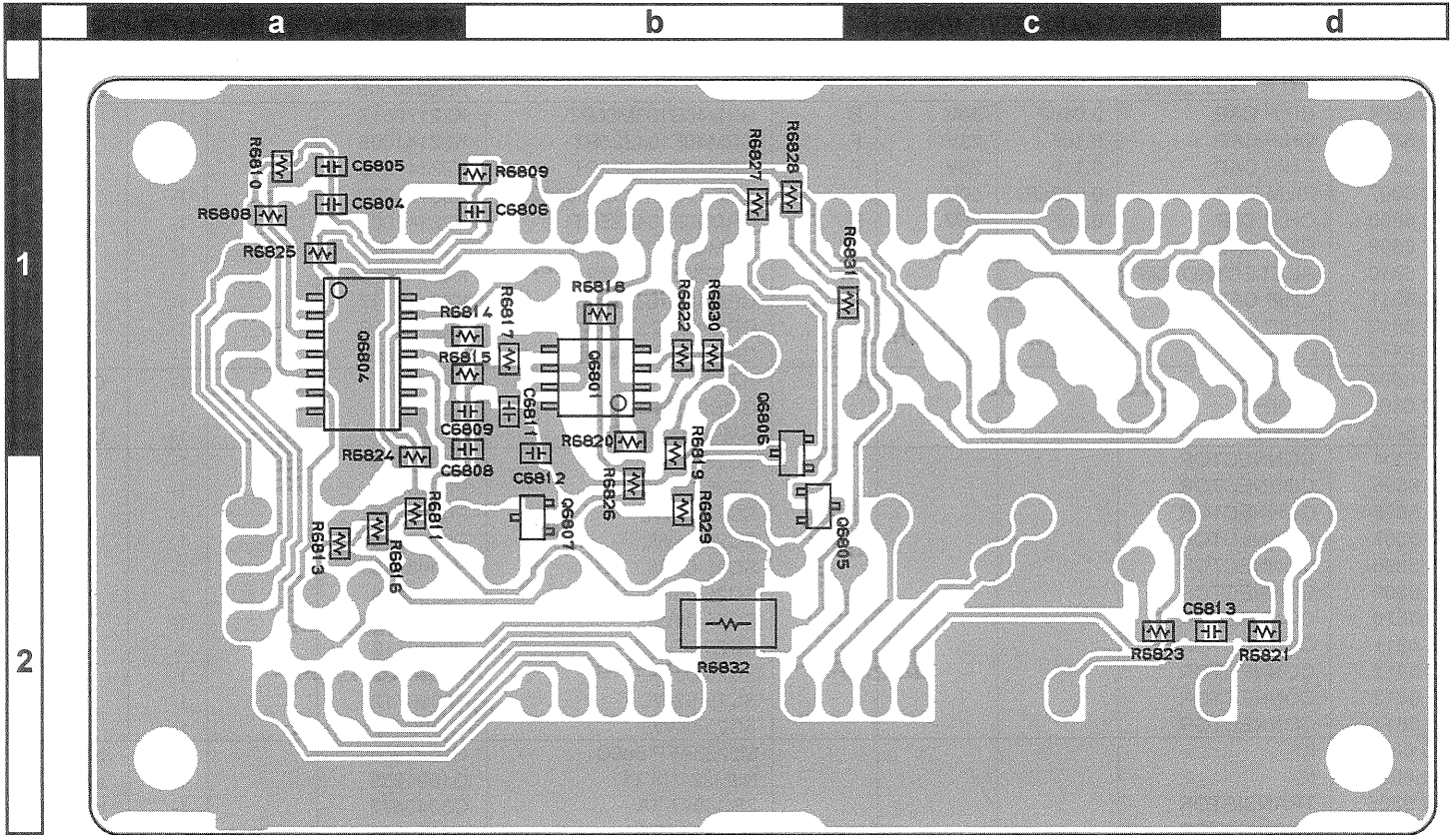

Side B

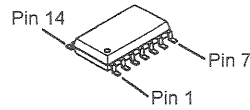

NJM2211M
(Q6804)

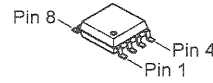

M5223AFP
(Q6801)

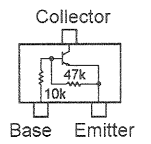

2SC4047 (ZY)
(Q6805, 6806, 6807)

ALC Unit

Parts List

REF.	DESCRIPTION	VALUE	V/W	TOL.	MFR'S DESIG	YAESU P/N	VERS.	LOT.	LAY ADR
PCB with Components						CB1202001			
P.C.B. W/O COMP.						FR006050B			
C 6804	CHIP CAP.	0.01uF	50V	B	GRM40B103M50PT	K22170817		1-	
C 6805	CHIP CAP.	0.1uF	25V	F	GRM40F104Z25PT	K22141005		1-	
C 6806	CHIP CAP.	0.1uF	25V	F	GRM40F104Z25PT	K22141005		1-	
C 6807	FILM CAP.	0.033uF	50V		AMZV0050K33300000200	K56170037		1-	
C 6808	CHIP CAP.	0.1uF	25V	F	GRM40F104Z25PT	K22141005		1-	
C 6809	CHIP CAP.	0.01uF	50V	B	GRM40B103M50PT	K22170817		1-	
C 6810	AL.ELECTRO.CAP.	0.33uF	50V		50VR33M4X7TR2	K46170028		1-	
C 6811	CHIP CAP.	0.01uF	50V	B	GRM40B103M50PT	K22170817		1-	
C 6812	CHIP CAP.	0.047uF	50V	F	GRM40F473Z50PT	K22171008		1-	
C 6813	CHIP CAP.	0.1uF	25V	F	GRM40F104Z25PT	K22141005		1-	
D 6804	DIODE				HZ7B1	G2090229		1-	C2
D 6805	DIODE				GMB01-BT	G2060016		1-	C2
D 6805	DIODE				GMA01U-BT	G2060023		11-	C2
J 6804	CONNECTOR				SC25-04WL	P0090713		1-	
J 6805	CONNECTOR				SC25-06WL	P0090639		1-	
J 6806	CONNECTOR				SC25-02WL	P0090712		1-	
J 6807	CONNECTOR				SC25-05WL	P0090638		1-	
J 6808	CONNECTOR				SC25-05WL	P0090638		1-	
J 6809	CONNECTOR				SC25-05WL	P0090638		1-	
J 6810	CONNECTOR				SC25-04WL	P0090713		1-	
J 6811	CONNECTOR				SC25-02WL	P0090712		1-	
J 6812	CONNECTOR				SC25-06WL	P0090639		1-	
J 6813	CONNECTOR				SC25-02WL	P0090712		1-	
J 6814	CONNECTOR				SC25-04WL	P0090713		1-	
Q 6801	IC				M5223AFP 600C	G1092955		1-	b1
Q 6804	IC				NJM2211M T1	G1091839		1-	a1
Q 6805	TRANSISTOR				2SC4047-TA	G3340477		1-	b2
Q 6805	TRANSISTOR				UN2214-(TX)	G3070206		8-	b2
Q 6806	TRANSISTOR				2SC4047-TA	G3340477		1-	b1
Q 6806	TRANSISTOR				UN2214-(TX)	G3070206		8-	b1
Q 6807	TRANSISTOR				2SC4047-TA	G3340477		1-	b2
Q 6807	TRANSISTOR				UN2214-(TX)	G3070206		8-	b2
R 6804	CARBON FILM RES.	47	1/6W	5%	RD16TPJ470 47	J07225470		1-	
R 6805	CARBON FILM RES.	47	1/6W	5%	RD16TPJ470 47	J07225470		1-	
R 6806	CARBON FILM RES.	47	1/6W	5%	RD16TPJ470 47	J07225470		1-	
R 6807	CARBON FILM RES.	47	1/6W	5%	RD16TPJ470 47	J07225470		1-	
R 6808	CHIP RES.	10k	1/10W	5%	RMC1/10T 103J	J24205103		1-	
R 6809	CHIP RES.	10k	1/10W	5%	RMC1/10T 103J	J24205103		1-	
R 6810	CHIP RES.	470k	1/10W	5%	RMC1/10T 474J	J24205474		1-	
R 6811	CHIP RES.	12k	1/10W	5%	RMC1/10T 123J	J24205123		1-	
R 6812	CARBON FILM RES.	100	1/6W	5%	RD16TPJ101 100	J07225101		1-	
R 6813	CHIP RES.	10k	1/10W	5%	RMC1/10T 103J	J24205103		1-	
R 6814	CHIP RES.	150k	1/10W	5%	RMC1/10T 154J	J24205154		1-	
R 6815	CHIP RES.	470k	1/10W	5%	RMC1/10T 474J	J24205474		1-	
R 6816	CHIP RES.	33k	1/10W	5%	RMC1/10T 333J	J24205333		1-	
R 6817	CHIP RES.	10k	1/10W	5%	RMC1/10T 103J	J24205103		1-	
R 6818	CHIP RES.	68k	1/10W	5%	RMC1/10T 683J	J24205683		1-	
R 6819	CHIP RES.	470	1/10W	5%	RMC1/10T 471J	J24205471		1-	
R 6820	CHIP RES.	100k	1/10W	5%	RMC1/10T 104J	J24205104		1-	
R 6821	CHIP RES.	10k	1/10W	5%	RMC1/10T 103J	J24205103		1-	
R 6822	CHIP RES.	1k	1/10W	5%	RMC1/10T 102J	J24205102		1-	
R 6823	CHIP RES.	2.2k	1/10W	5%	RMC1/10T 222J	J24205222		1-	
R 6824	CHIP RES.	0	1/10W	5%	RMC1/10T 000J	J24205000		1-	
R 6825	CHIP RES.	0	1/10W	5%	RMC1/10T 000J	J24205000		1-	
R 6826	CHIP RES.	0	1/10W	5%	RMC1/10T 000J	J24205000		1-	
R 6827	CHIP RES.	0	1/10W	5%	RMC1/10T 000J	J24205000		1-	
R 6828	CHIP RES.	0	1/10W	5%	RMC1/10T 000J	J24205000		1-	
R 6829	CHIP RES.	0	1/10W	5%	RMC1/10T 000J	J24205000		1-	
R 6830	CHIP RES.	0	1/10W	5%	RMC1/10T 000J	J24205000		1-	
R 6831	CHIP RES.	0	1/10W	5%	RMC1/10T 000J	J24205000		1-	
R 6832	CHIP RES.	0	1W	5%	RMC1 JPATE	J24305000		1-	
VR6804	POT.	100			EVN-DXAA03B12 100	J51783101		1-	
VR6805	POT.	100			EVN-DXAA03B12 100	J51783101		1-	
VR6806	POT.	100			EVN-DXAA03B12 100	J51783101		1-	
VR6807	POT.	100			EVN-DXAA03B12 100	J51783101		1-	
VR6808	POT.	20k			EVN-DXAA03B24 20K	J51783203		1-	

ALC Unit

Note

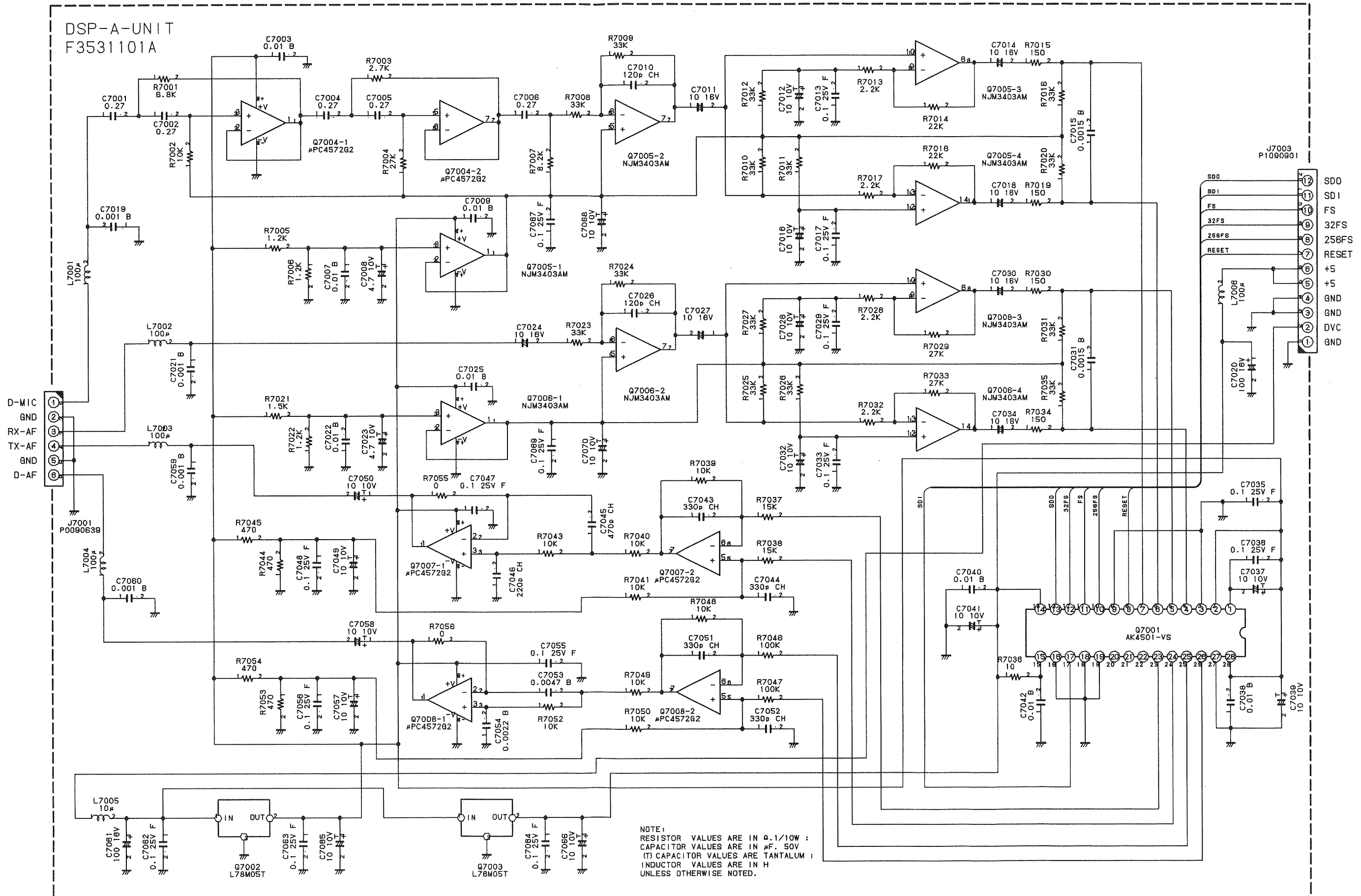

DSP-A Unit

Parts Layout

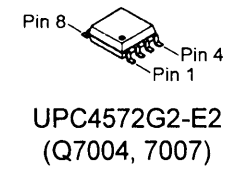
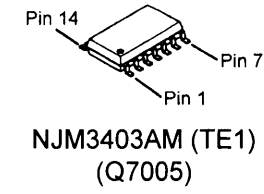
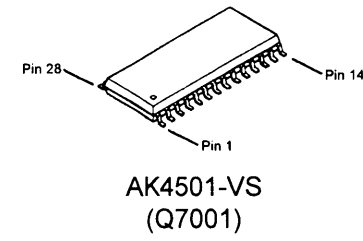
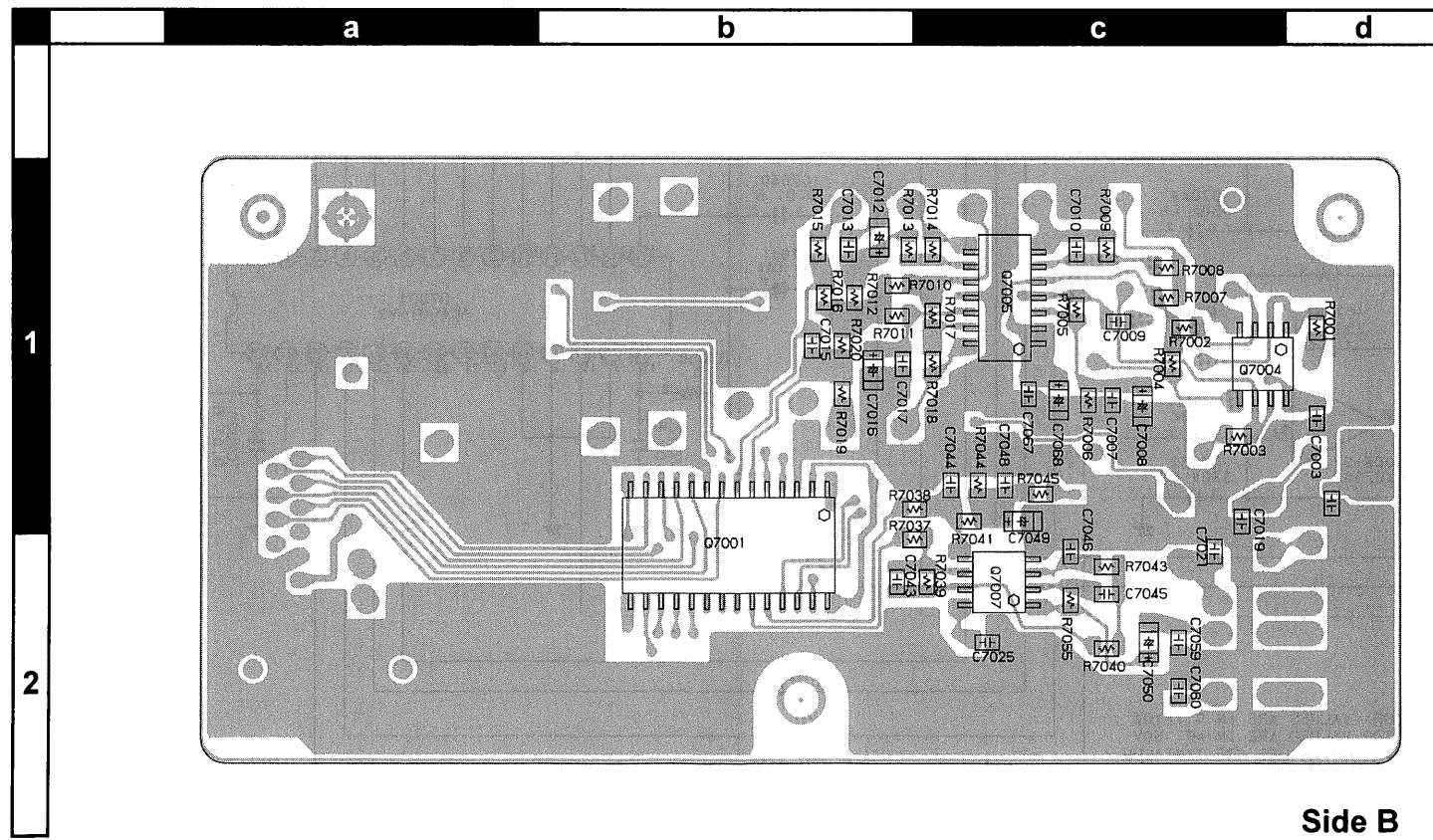
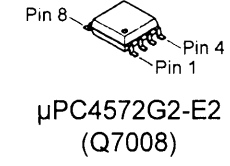
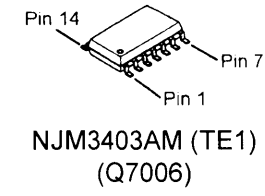
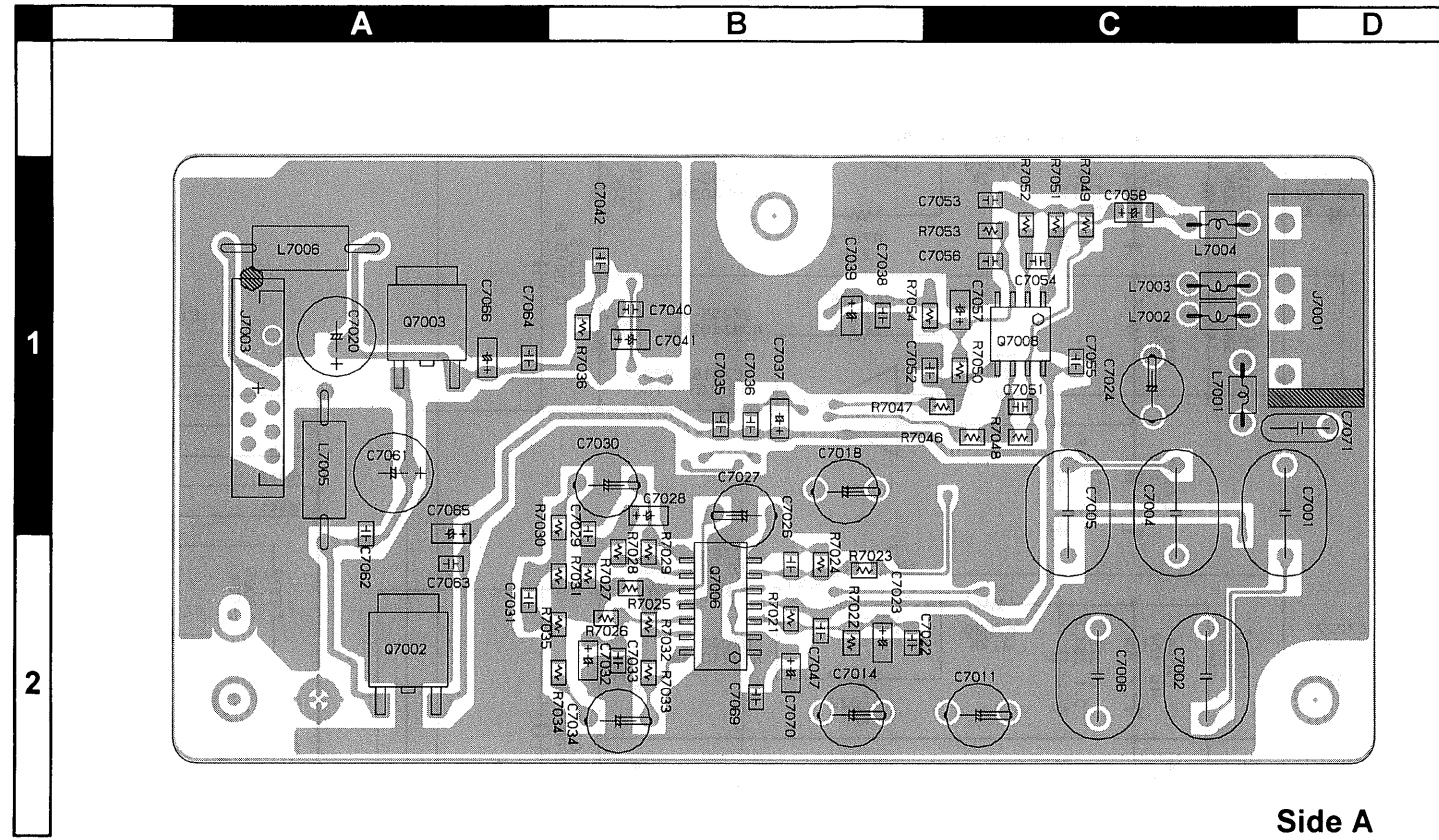

REF.	DESCRIPTION	VALUE	V/W	TOL.	MFR'S DESIG	YAESU P/N	VERS.	LOT.	LAY ADR
P.C.B. with Components						CB1203001			
Printed Circuit Board						F3531101A		1	
C 7001	FILM CAP.				MMT0050J27400000000	K50170105		1	
C 7002	FILM CAP.				MMT0050J27400000000	K50170105		1	
C 7003	CHIP CAP.	0.01uF	50V	B	GRM40B103M50PT	K22170817		1	
C 7004	FILM CAP.				MMT0050J27400000000	K50170105		1	
C 7005	FILM CAP.				MMT0050J27400000000	K50170105		1	
C 7006	FILM CAP.				MMT0050J27400000000	K50170105		1	
C 7007	CHIP CAP.	0.01uF	50V	B	GRM40B103M50PT	K22170817		1	
C 7008	CHIP TA.CAP.	4.7uF	10V		TEMSVA1A475M-8R	K78100022		1	
C 7009	CHIP CAP.	0.01uF	50V	B	GRM40B103M50PT	K22170817		1	
C 7010	CHIP CAP.	120pF	50V	CH	GRM40CH121J50PT	K22170237		1	
C 7011	AL.ELECTRO.CAP.	10uF	16V		RB2-16V100M-T2	K46120011		1	
C 7012	CHIP TA.CAP.	10uF	10V		TEMSVA1A106M-8R	K78100028		1	
C 7013	CHIP CAP.	0.1uF	25V	F	GRM40F104Z25PT	K22141005		1	
C 7014	AL.ELECTRO.CAP.	10uF	16V		RB2-16V100M-T2	K46120011		1	
C 7015	CHIP CAP.	0.0015uF	50V	B	GRM40B152M50PT	K22170807		1	
C 7016	CHIP TA.CAP.	10uF	10V		TEMSVA1A106M-8R	K78100028		1	
C 7017	CHIP CAP.	0.1uF	25V	F	GRM40F104Z25PT	K22141005		1	
C 7018	AL.ELECTRO.CAP.	10uF	16V		RB2-16V100M-T2	K46120011		1	
C 7019	CHIP CAP.	0.001uF	50V	B	GRM40B102M50PT	K22170805		1	
C 7020	AL.ELECTRO.CAP.	100uF	16V		16V101M6X7TR2	K46120007		1	
C 7021	CHIP CAP.	0.001uF	50V	B	GRM40B102M50PT	K22170805		1	
C 7022	CHIP CAP.	0.01uF	50V	B	GRM40B103M50PT	K22170817		1	
C 7023	CHIP TA.CAP.	4.7uF	10V		TEMSVA1A475M-8R	K78100022		1	
C 7024	AL.ELECTRO.CAP.	10uF	16V		RB2-16V100M-T2	K46120011		1	
C 7025	CHIP CAP.	0.01uF	50V	B	GRM40B103M50PT	K22170817		1	
C 7026	CHIP CAP.	120pF	50V	CH	GRM40CH121J50PT	K22170237		1	
C 7027	AL.ELECTRO.CAP.	10uF	16V		RB2-16V100M-T2	K46120011		1	
C 7028	CHIP TA.CAP.	10uF	10V		TEMSVA1A106M-8R	K78100028		1	
C 7029	CHIP CAP.	0.1uF	25V	F	GRM40F104Z25PT	K22141005		1	
C 7030	AL.ELECTRO.CAP.	10uF	16V		RB2-16V100M-T2	K46120011		1	
C 7031	CHIP CAP.	0.0015uF	50V	B	GRM40B152M50PT	K22170807		1	
C 7032	CHIP TA.CAP.	10uF	10V		TEMSVA1A106M-8R	K78100028		1	
C 7033	CHIP CAP.	0.1uF	25V	F	GRM40F104Z25PT	K22141005		1	
C 7034	AL.ELECTRO.CAP.	10uF	16V		RB2-16V100M-T2	K46120011		1	
C 7035	CHIP CAP.	0.1uF	25V	F	GRM40F104Z25PT	K22141005		1	
C 7036	CHIP CAP.	0.1uF	25V	F	GRM40F104Z25PT	K22141005		1	
C 7037	CHIP TA.CAP.	10uF	10V		TEMSVA1A106M-8R	K78100028		1	
C 7038	CHIP CAP.	0.01uF	50V	B	GRM40B103M50PT	K22170817		1	
C 7039	CHIP TA.CAP.	10uF	10V		TEMSVA1A106M-8R	K78100028		1	
C 7040	CHIP CAP.	0.01uF	50V	B	GRM40B103M50PT	K22170817		1	
C 7041	CHIP TA.CAP.	10uF	10V		TEMSVA1A106M-8R	K78100028		1	
C 7042	CHIP CAP.	0.01uF	50V	B	GRM40B103M50PT	K22170817		1	
C 7043	CHIP CAP.	330pF	50V	CH	GRM40CH331J50PT	K22170247		1	
C 7044	CHIP CAP.	330pF	50V	CH	GRM40CH331J50PT	K22170247		1	
C 7045	CHIP CAP.	470pF	50V	CH	GRM40CH471J50PT	K22170251		1	
C 7046	CHIP CAP.	220pF	50V	CH	GRM40CH221J50PT	K22170243		1	
C 7047	CHIP CAP.	0.1uF	25V	F	GRM40F104Z25PT	K22141005		1	
C 7048	CHIP CAP.	0.1uF	25V	F	GRM40F104Z25PT	K22141005		1	
C 7049	CHIP TA.CAP.	10uF	10V		TEMSVA1A106M-8R	K78100028		1	
C 7050	CHIP TA.CAP.	10uF	10V		TEMSVA1A106M-8R	K78100028		1	
C 7051	CHIP CAP.	330pF	50V	CH	GRM40CH331J50PT	K22170247		1	
C 7052	CHIP CAP.	330pF	50V	CH	GRM40CH331J50PT	K22170247		1	
C 7053	CHIP CAP.	0.0047uF	50V	B	GRM40B472M50PT	K22170813		1	
C 7054	CHIP CAP.	0.0022uF	50V	B	GRM40B222M50PT	K22170809		1	
C 7055	CHIP CAP.	0.1uF	25V	F	GRM40F104Z25PT	K22141005		1	
C 7056	CHIP CAP.	0.1uF	25V	F	GRM40F104Z25PT	K22141005		1	
C 7057	CHIP TA.CAP.	10uF	10V		TEMSVA1A106M-8R	K78100028		1	
C 7058	CHIP TA.CAP.	10uF	10V		TEMSVA1A106M-8R	K78100028		1	
C 7059	CHIP CAP.	0.001uF	50V	B	GRM40B102M50PT	K22170805		1	
C 7060	CHIP CAP.	0.001uF	50V	B	GRM40B102M50PT	K22170805		1	
C 7061	AL.ELECTRO.CAP.	100uF	16V		16V101M6X7TR2	K46120007		1	
C 7062	CHIP CAP.	0.1uF	25V	F	GRM40F104Z25PT	K22141005		1	
C 7063	CHIP CAP.	0.1uF	25V	F	GRM40F104Z25PT	K22141005		1	
C 7064	CHIP CAP.	0.1uF	25V	F	GRM40F104Z25PT	K22141005		1	
C 7065	CHIP TA.CAP.	10uF	10V		TEMSVA1A106M-8R	K78100028		1	
C 7066	CHIP TA.CAP.	10uF	10V		TEMSVA1A106M-8R	K78100028		1	

DSP-A Unit

Parts List

REF.	DESCRIPTION	VALUE	V/W	TOL.	MFR'S DESIG	YAESU P/N	VERS.	LOT.	LAY ADR
C 7067	CHIP CAP.	0.1uF	25V	F	GRM40F104Z25PT	K22141005		1	
C 7068	CHIP TA.CAP.	10uF	10V		TEMSVA1A106M-8R	K78100028		1	
C 7069	CHIP CAP.	0.1uF	25V	F	GRM40F104Z25PT	K22141005		1	
C 7070	CHIP TA.CAP.	10uF	10V		TEMSVA1A106M-8R	K78100028		1	
C 7071	CERAMIC CAP.	100pF	50V	CH	DD107CH101J50	K02175101		1	
J 7001	CONNECTOR				SC25-06WL	P0090639		1	
J 7003	CONNECTOR				12FMZ-BT	P1090901		1	
L 7001	M.RFC	100uH			LAP02TA101K	L1790070		1	
L 7002	M.RFC	100uH			LAP02TA101K	L1790070		1	
L 7003	M.RFC	100uH			LAP02TA101K	L1790070		1	
L 7004	M.RFC	100uH			LAP02TA101K	L1790070		1	
L 7005	M.RFC	10uH			LAL04NA100K	L1190138		1	
L 7006	M.RFC	100uH			LAL04NA101K	L1190133		1	
Q 7001	IC				AK4501-VS	G1091943		1	b2
Q 7002	IC				L78M05T-TL	G1091731		1	A2
Q 7003	IC				L78M05T-TL	G1091731		1	A1
Q 7004	IC				UPC4572G2-E2	G1092042		1	c1
Q 7005	IC				NJM3403AM(TE1)	G1093089		1	c1
Q 7006	IC				NJM3403AM(TE1)	G1093089		1	B2
Q 7007	IC				UPC4572G2-E2	G1092042		1	c2
Q 7008	IC				UPC4572G2-E2	G1092042		1	C1
R 7001	CHIP RES.	6.8k	1/10W	5%	RMC1/10T 682J	J24205682		1	
R 7002	CHIP RES.	10k	1/10W	5%	RMC1/10T 103J	J24205103		1	
R 7003	CHIP RES.	2.7k	1/10W	5%	RMC1/10T 272J	J24205272		1	
R 7004	CHIP RES.	27k	1/10W	5%	RMC1/10T 273J	J24205273		1	
R 7005	CHIP RES.	1.2k	1/10W	5%	RMC1/10T 122J	J24205122		1	
R 7006	CHIP RES.	1.2k	1/10W	5%	RMC1/10T 122J	J24205122		1	
R 7007	CHIP RES.	8.2k	1/10W	5%	RMC1/10T 822J	J24205822		1	
R 7008	CHIP RES.	33k	1/10W	5%	RMC1/10T 333J	J24205333		1	
R 7009	CHIP RES.	33k	1/10W	5%	RMC1/10T 333J	J24205333		1	
R 7010	CHIP RES.	33k	1/10W	5%	RMC1/10T 333J	J24205333		1	
R 7011	CHIP RES.	33k	1/10W	5%	RMC1/10T 333J	J24205333		1	
R 7012	CHIP RES.	33k	1/10W	5%	RMC1/10T 333J	J24205333		1	
R 7013	CHIP RES.	2.2k	1/10W	5%	RMC1/10T 222J	J24205222		1	
R 7014	CHIP RES.	22k	1/10W	5%	RMC1/10T 223J	J24205223		1	
R 7015	CHIP RES.	150	1/10W	5%	RMC1/10T 151J	J24205151		1	
R 7016	CHIP RES.	33k	1/10W	5%	RMC1/10T 333J	J24205333		1	
R 7017	CHIP RES.	2.2k	1/10W	5%	RMC1/10T 222J	J24205222		1	
R 7018	CHIP RES.	22k	1/10W	5%	RMC1/10T 223J	J24205223		1	
R 7019	CHIP RES.	150	1/10W	5%	RMC1/10T 151J	J24205151		1	
R 7020	CHIP RES.	33k	1/10W	5%	RMC1/10T 333J	J24205333		1	
R 7021	CHIP RES.	1.5k	1/10W	5%	RMC1/10T 152J	J24205152		1	
R 7022	CHIP RES.	1.2k	1/10W	5%	RMC1/10T 122J	J24205122		1	
R 7023	CHIP RES.	33k	1/10W	5%	RMC1/10T 333J	J24205333		1	
R 7024	CHIP RES.	33k	1/10W	5%	RMC1/10T 333J	J24205333		1	
R 7025	CHIP RES.	33k	1/10W	5%	RMC1/10T 333J	J24205333		1	
R 7026	CHIP RES.	33k	1/10W	5%	RMC1/10T 333J	J24205333		1	
R 7027	CHIP RES.	33k	1/10W	5%	RMC1/10T 333J	J24205333		1	
R 7028	CHIP RES.	2.2k	1/10W	5%	RMC1/10T 222J	J24205222		1	
R 7029	CHIP RES.	27k	1/10W	5%	RMC1/10T 273J	J24205273		1	
R 7030	CHIP RES.	150	1/10W	5%	RMC1/10T 151J	J24205151		1	
R 7031	CHIP RES.	33k	1/10W	5%	RMC1/10T 333J	J24205333		1	
R 7032	CHIP RES.	2.2k	1/10W	5%	RMC1/10T 222J	J24205222		1	
R 7033	CHIP RES.	27k	1/10W	5%	RMC1/10T 273J	J24205273		1	
R 7034	CHIP RES.	150	1/10W	5%	RMC1/10T 151J	J24205151		1	
R 7035	CHIP RES.	33k	1/10W	5%	RMC1/10T 333J	J24205333		1	
R 7036	CHIP RES.	10	1/10W	5%	RMC1/10T 100J	J24205100		1	
R 7037	CHIP RES.	15k	1/10W	5%	RMC1/10T 153J	J24205153		1	
R 7038	CHIP RES.	15k	1/10W	5%	RMC1/10T 153J	J24205153		1	
R 7039	CHIP RES.	10k	1/10W	5%	RMC1/10T 103J	J24205103		1	
R 7040	CHIP RES.	10k	1/10W	5%	RMC1/10T 103J	J24205103		1	
R 7041	CHIP RES.	10k	1/10W	5%	RMC1/10T 103J	J24205103		1	
R 7043	CHIP RES.	10k	1/10W	5%	RMC1/10T 103J	J24205103		1	
R 7044	CHIP RES.	470	1/10W	5%	RMC1/10T 471J	J24205471		1	
R 7045	CHIP RES.	470	1/10W	5%	RMC1/10T 471J	J24205471		1	
R 7046	CHIP RES.	100k	1/10W	5%	RMC1/10T 104J	J24205104		1	
R 7047	CHIP RES.	100k	1/10W	5%	RMC1/10T 104J	J24205104		1	
R 7048	CHIP RES.	10k	1/10W	5%	RMC1/10T 103J	J24205103		1	

DSP-A Unit

Parts List

REF.	DESCRIPTION	VALUE	V/W	TOL.	MFR'S DESIG	YAESU P/N	VERS.	LOT.	LAY ADR
R 7049	CHIP RES.	10k	1/10W	5%	RMC1/10T 103J	J24205103		1	
R 7050	CHIP RES.	10k	1/10W	5%	RMC1/10T 103J	J24205103		1	
R 7052	CHIP RES.	10k	1/10W	5%	RMC1/10T 103J	J24205103		1	
R 7053	CHIP RES.	470	1/10W	5%	RMC1/10T 471J	J24205471		1	
R 7054	CHIP RES.	470	1/10W	5%	RMC1/10T 471J	J24205471		1	
R 7055	CHIP RES.	0	1/10W	5%	RMC1/10T 000J	J24205000		1	
R 7056	CHIP RES.	0	1/10W	5%	RMC1/10T 000J	J24205000		1	
Z 7001	SHIELD PLATE					R0152130		1	
Z 7002	SHIELD CASE					R0521470		1	
Z 7003	SHIELD CASE COVER					R0521480		1	
Z 7004	HIMERON TAPE					R7152112		1	

DSP-A Unit

Note

DSP-D Unit

Parts Layout

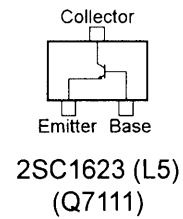
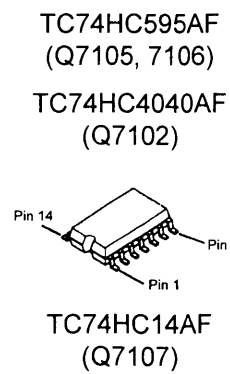
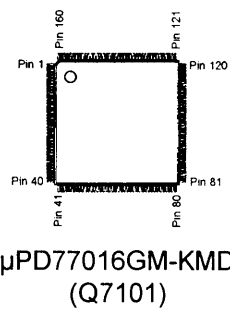
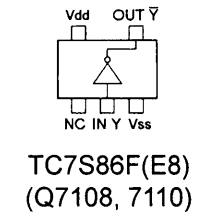
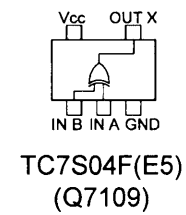
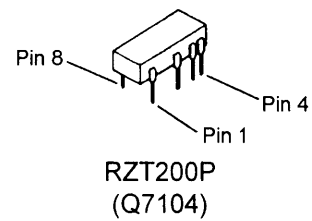
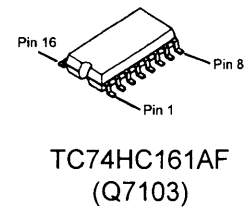
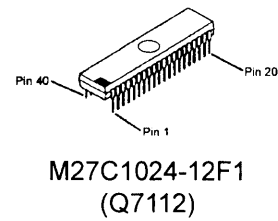
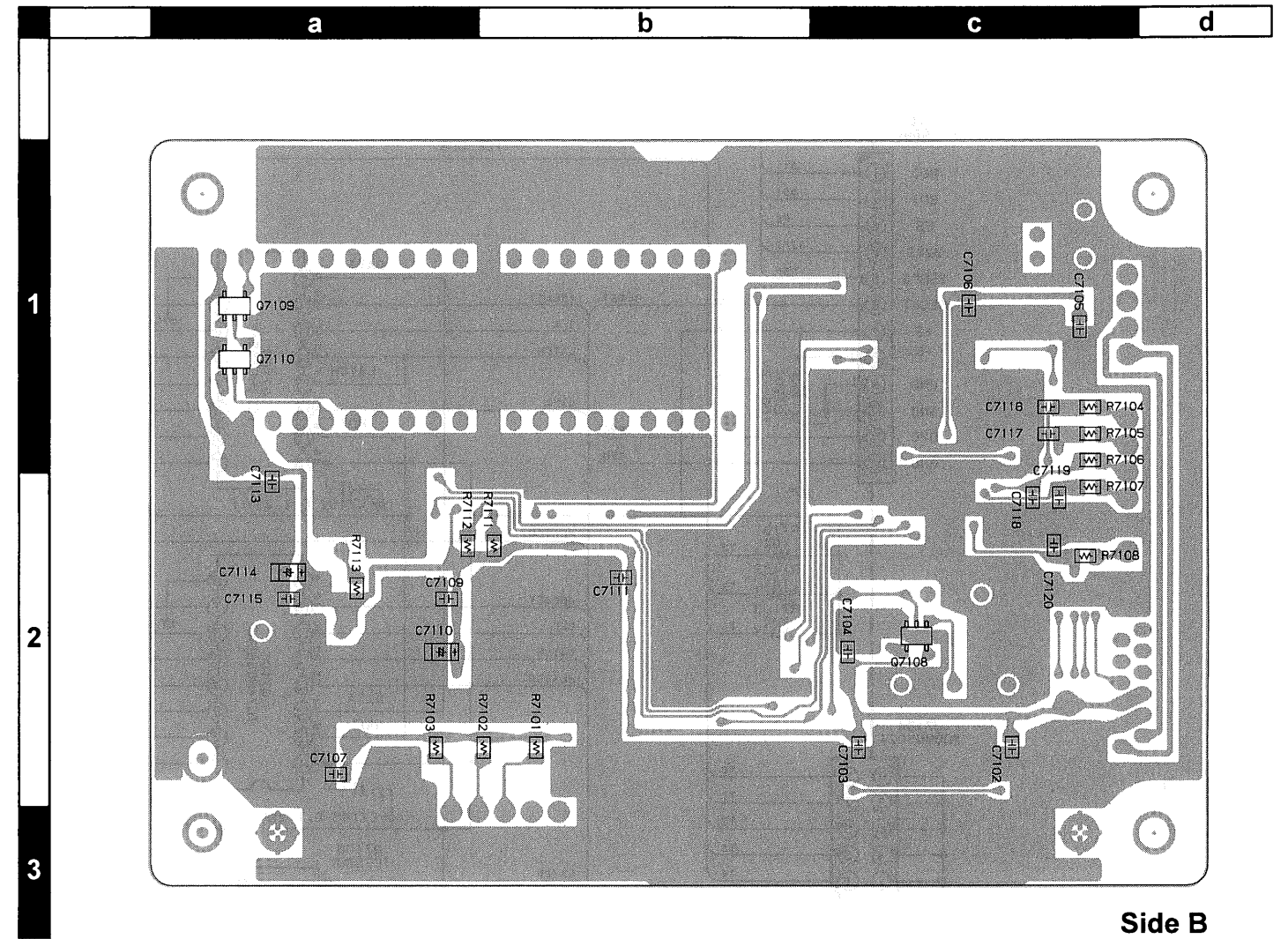
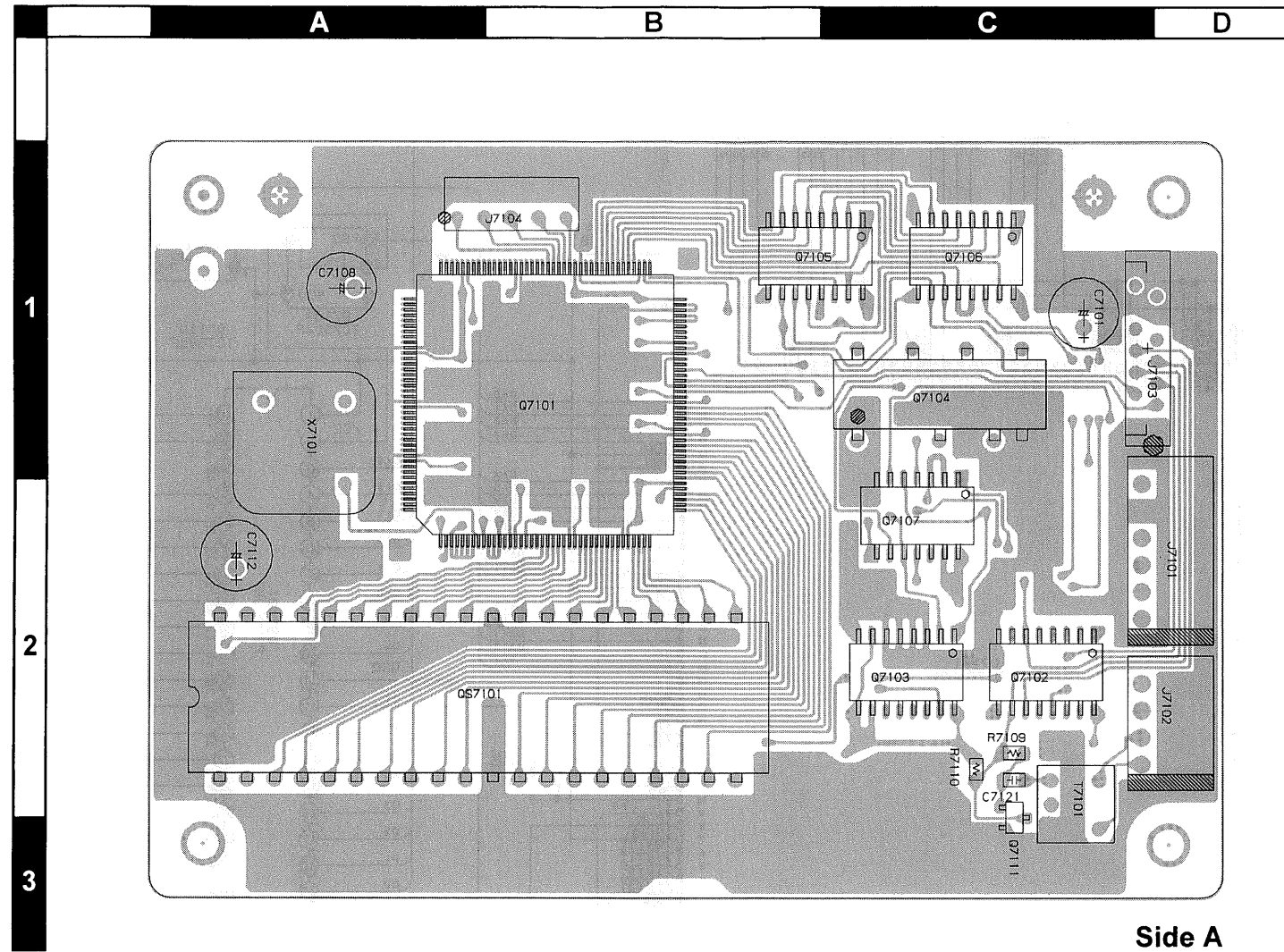

REF.	DESCRIPTION	VALUE	V/W	TOL.	MFR'S DESIG	YAESU P/N	VERS.	LOT.	LAY ADR
P.C.B. with Components						CB1204001			
Printed Circuit Board						F3531102A		1	
C 7101	AL.ELECTRO.CAP.	100uF	16V		16V101M6X7TR2	K46120007		1	
C 7102	CHIP CAP.	0.1uF	25V	F	GRM40F104Z25PT	K22141005		1	
C 7103	CHIP CAP.	0.1uF	25V	F	GRM40F104Z25PT	K22141005		1	
C 7104	CHIP CAP.	0.1uF	25V	F	GRM40F104Z25PT	K22141005		1	
C 7105	CHIP CAP.	0.1uF	25V	F	GRM40F104Z25PT	K22141005		1	
C 7106	CHIP CAP.	0.1uF	25V	F	GRM40F104Z25PT	K22141005		1	
C 7107	CHIP CAP.	0.1uF	25V	F	GRM40F104Z25PT	K22141005		1	
C 7108	AL.ELECTRO.CAP.	100uF	16V		16V101M6X7TR2	K46120007		1	
C 7109	CHIP CAP.	0.1uF	25V	F	GRM40F104Z25PT	K22141005		1	
C 7110	CHIP TA.CAP.	10uF	10V		TEMSVA1A106M-8R	K78100028		1	
C 7111	CHIP CAP.	0.01uF	50V	B	GRM40B103M50PT	K22170817		1	
C 7112	AL.ELECTRO.CAP.	100uF	16V		16V101M6X7TR2	K46120007		1	
C 7113	CHIP CAP.	0.1uF	25V	F	GRM40F104Z25PT	K22141005		1	
C 7114	CHIP TA.CAP.	10uF	10V		TEMSVA1A106M-8R	K78100028		1	
C 7115	CHIP CAP.	0.01uF	50V	B	GRM40B103M50PT	K22170817		1	
C 7116	CHIP CAP.	10pF	50V	CH	GRM40CH100D50PT	K22170211		1	
C 7117	CHIP CAP.	10pF	50V	CH	GRM40CH100D50PT	K22170211		1	
C 7118	CHIP CAP.	10pF	50V	CH	GRM40CH100D50PT	K22170211		1	
C 7119	CHIP CAP.	10pF	50V	CH	GRM40CH100D50PT	K22170211		1	
C 7120	CHIP CAP.	10pF	50V	CH	GRM40CH100D50PT	K22170211		1	
C 7121	CHIP CAP.	0.01uF	50V	B	GRM40B103M50PT	K22170817		1	
J 7101	CONNECTOR				SC25-06WL	P0090639		1	
J 7102	CONNECTOR				SC25-04WL	P0090713		1	
J 7103	CONNECTOR				12FMZ-BT	P1090901		1	
Q 7101	IC				UPD77016GM-KMD	G1092034		1	B1
Q 7102	IC				TC74HC4040AF TP2	G1091457		1	C2
Q 7103	IC				TC74HC161AF TP2	G1091227		1	C2
Q 7104	IC				RZT200P	G1092041		1	C1
Q 7105	IC				TC74HC595AF(EL)	G1092039		1	C1
Q 7106	IC				TC74HC595AF(EL)	G1092039		1	C1
Q 7107	IC				TC74HC14AF(EL)	G1092038		1	C2
Q 7108	IC				TC7S86F TE85R	G1092040		1	c2
Q 7109	IC				TC7S04F TE85R	G1091444		1	a1
Q 7110	IC				TC7S86F TE85R	G1092040		1	a1
Q 7111	TRANSISTOR				2SC1623-T2BL6	G3316237F		1	C3
Q 7112	IC				M27C1024-12F1 R0112	G1092579		1	B2
QS7101	IC SOCKET				XR2A-4011-N	P3090087		1	
R 7101	CHIP RES.	10k	1/10W	5%	RMC1/10T 103J	J24205103		1	
R 7102	CHIP RES.	10k	1/10W	5%	RMC1/10T 103J	J24205103		1	
R 7103	CHIP RES.	10k	1/10W	5%	RMC1/10T 103J	J24205103		1	
R 7104	CHIP RES.	2.7k	1/10W	5%	RMC1/10T 272J	J24205272		1	
R 7105	CHIP RES.	2.7k	1/10W	5%	RMC1/10T 272J	J24205272		1	
R 7106	CHIP RES.	2.7k	1/10W	5%	RMC1/10T 272J	J24205272		1	
R 7107	CHIP RES.	2.7k	1/10W	5%	RMC1/10T 272J	J24205272		1	
R 7108	CHIP RES.	2.7k	1/10W	5%	RMC1/10T 272J	J24205272		1	
R 7109	CHIP RES.	100k	1/10W	5%	RMC1/10T 104J	J24205104		1	
R 7110	CHIP RES.	680	1/10W	5%	RMC1/10T 681J	J24205681		1	
R 7111	CHIP RES.	10k	1/10W	5%	RMC1/10T 103J	J24205103		1	
R 7112	CHIP RES.	10k	1/10W	5%	RMC1/10T 103J	J24205103		1	
R 7113	CHIP RES.	2.2k	1/10W	5%	RMC1/10T 222J	J24205222		1	
T 7101	COIL 07WIDE				TR6-3-2	L0021484		1	
X 7101	XTAL OSC	66.666MHz			NT0-764DC-66.666MHZ	H9500270		1	

DSP-D Unit

Note

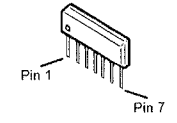

μ PC1037H
(Q8043, 8057)

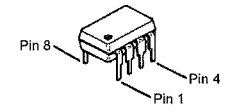

SN16913P
(Q8038, 8055)

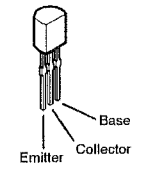

2SC732TMBL
(Q8062)

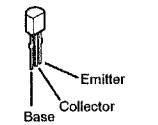

2SC2053
(Q8036)

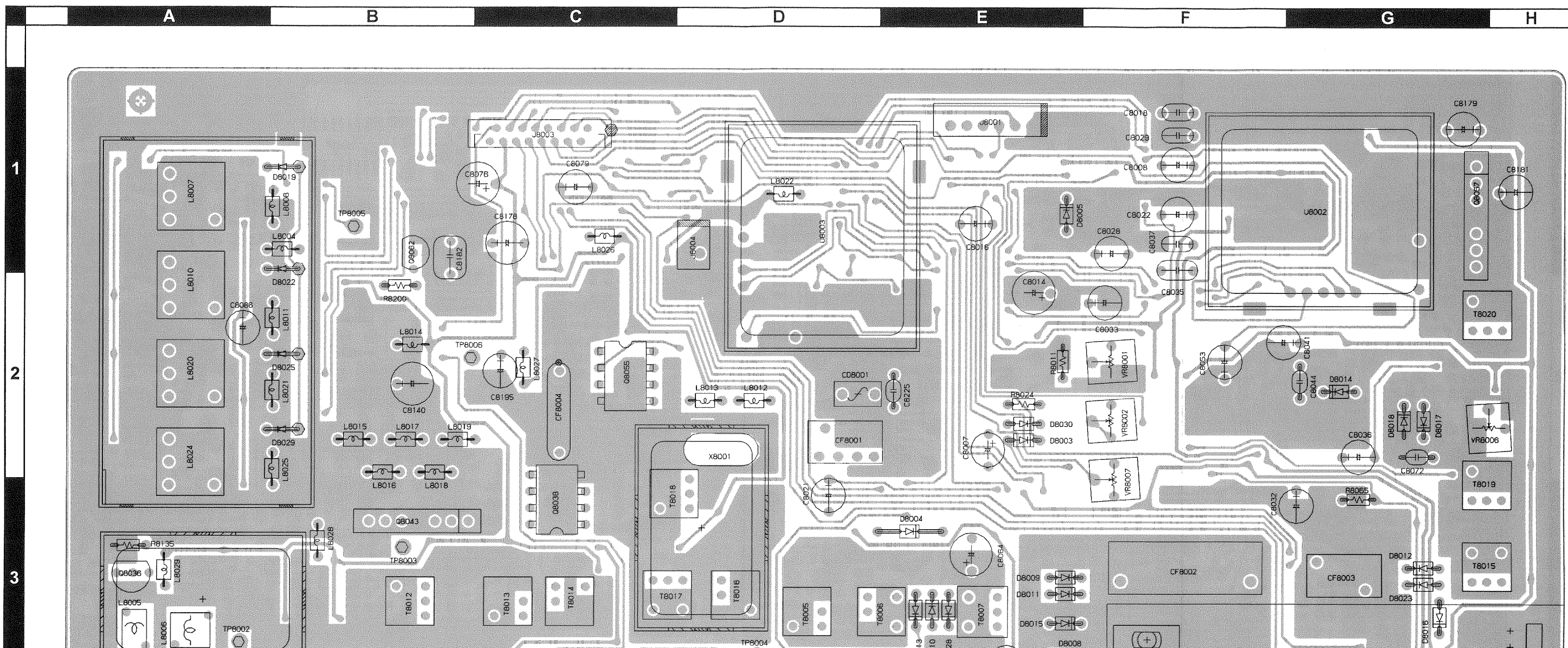

RX2 Unit (Lot. 1~)

Parts Layout



Side B

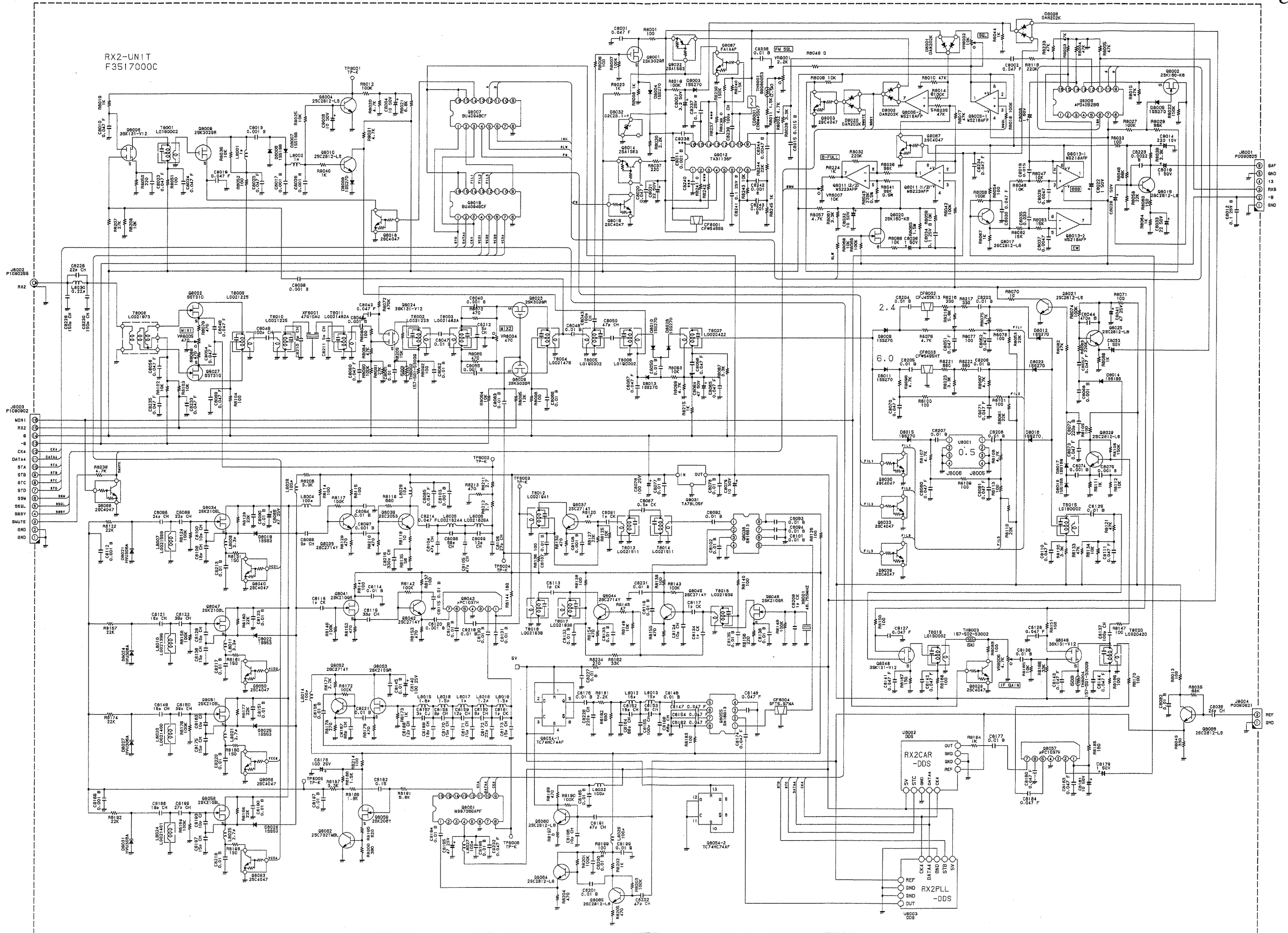

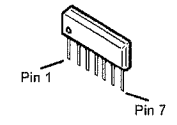

μPC1037H
(Q8043, 8057)

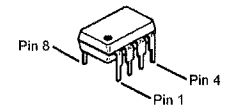

SN16913P
(Q8038, 8055)

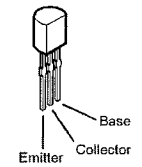

2SC732TMBL
(Q8062)

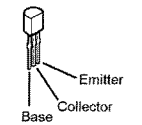

2SC2053
(Q8036)

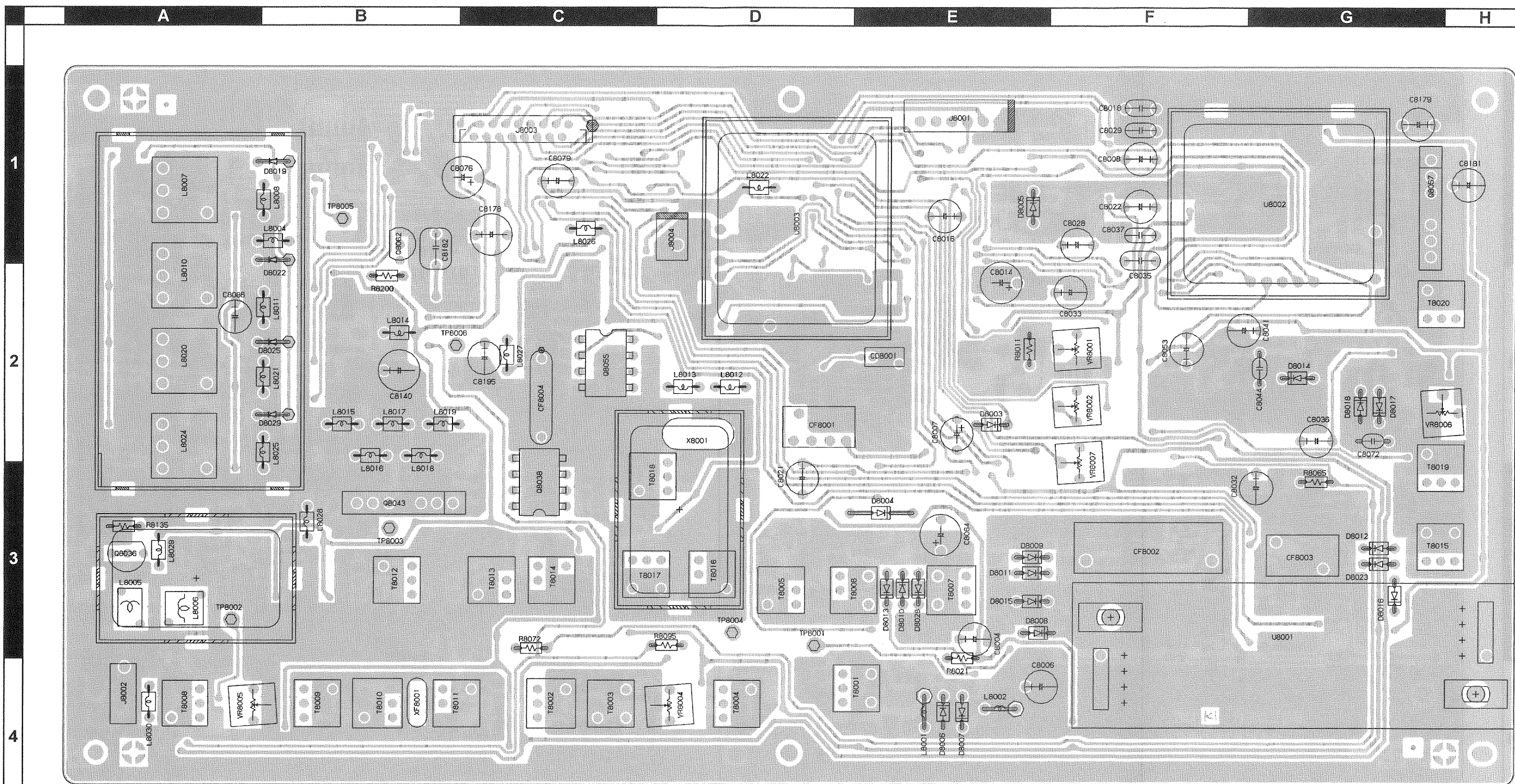

Side A

RX-2 Unit (Lot. 30-)
Parts Layout

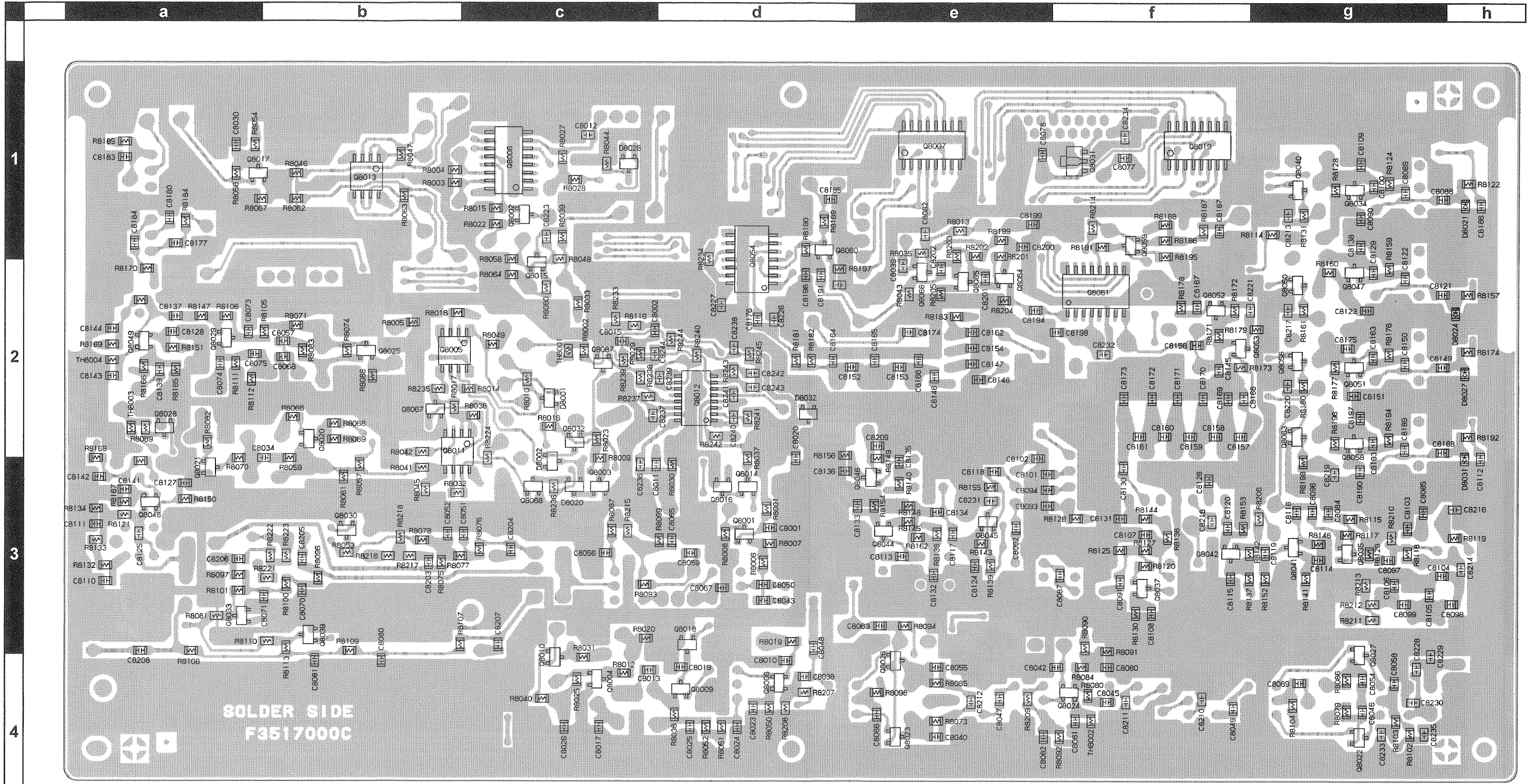

Side B

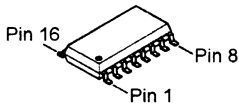

MB87086
(Q8061)

MC3372ML
(Q8012)

μPD4052BG
(Q8006)

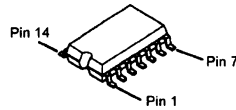

TC74HC74AF
(Q8054)

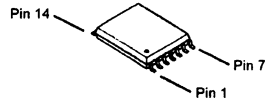

BU4094BCF
(Q8007, 8019)

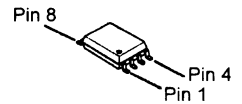

M5218AFP
(Q8005, 8013)



M5223AFP
(Q8011)

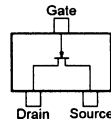

SST310-T1 (ZO)
(Q8022, 8027)

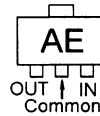

TA78L05F (AE)
(Q8031)

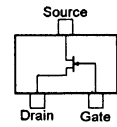

2SK210BL (YB)
(Q8034, 8047, 8051, 8058)

2SK210GR (YG)
(Q8041, 8046, 8053)

2SK302GR (TG)
(Q8001, 8009, 8023, 8026)

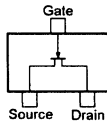

2SK160 (K6)
(Q8002, 8020)

2SK208Y (JY)
(Q8059)

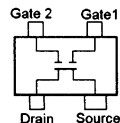

3SK131 (V12)
(Q8008, 8024,
8048, 8049)

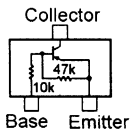

2SA1563 (RL)
(Q8014, 8032)

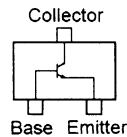

2SC2714Y (QY)
(Q8035, 8037, 8042,
8044, 8045, 8052)

2SC2812 (L6)
(Q8004, 8010, 8015,
8017, 8021, 8025,
8029, 8060, 8064,
8065, 8066)

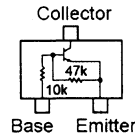

2SC4047 (ZY)
(Q8016, 8018, 8028,
8030, 8033, 8039,
8040, 8050, 8056,
8063, 8067, 8068)

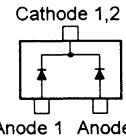

DAN202K (N)
(D8001, 8002,
8020, 8026)

RX-2 Unit

Parts List

REF.	DESCRIPTION	VALUE	V/W	TOL.	MFR'S DESIG	YAESU P/N	VERS.	LOT.	LAY ADR
PCB with Components						CP6695001			
Printed Circuit Board						F3517000A		1-	
Printed Circuit Board						F3517000C		30-	
C 8001	CHIP CAP.	0.047uF	50V	F	GRM40F473Z50PT	K22171008		1-	
C 8002	CHIP CAP.	0.047uF	50V	F	GRM40F473Z50PT	K22171008		1-	
C 8003	CHIP CAP.	0.047uF	50V	F	GRM40F473Z50PT	K22171008		1-	
C 8004	AL.ELECTRO.CAP.	10uF	50V		50V100M5X11TR5	K46170021		1-	
C 8005	CHIP CAP.	0.001uF	50V	B	GRM40B102M50PT	K22170805		1-	
C 8006	AL.ELECTRO.CAP.	10uF	50V		50V100M5X11TR5	K46170021		1-	
C 8007	AL.ELECTRO.CAP.	3.3uF	50V		RE2-50V3R3MMA 3.3UF	K40179011		1-	
C 8008	AL.ELECTRO.CAP.	1uF	50V		50V010M5X11TR5	K46170017		1-	
C 8009	CHIP CAP.	0.001uF	50V	B	GRM40B102M50PT	K22170805		1-	
C 8010	CHIP CAP.	0.047uF	50V	F	GRM40F473Z50PT	K22171008		1-	
C 8011	CHIP CAP.	0.001uF	50V	B	GRM40B102M50PT	K22170805		1-	
C 8012	CHIP CAP.	0.1uF	25V	B	GRM40B104M25PT	K22140811		1-	
C 8013	CHIP CAP.	0.001uF	50V	B	GRM40B102M50PT	K22170805		1-	
C 8014	AL.ELECTRO.CAP.	220uF	10V		10V221M6X11TR5	K46100005		1-	
C 8015	CHIP CAP.	0.015uF	50V	B	GRM40B153M50PT	K22170819		1-	
C 8016	AL.ELECTRO.CAP.	1uF	50V		50V010M5X11TR5	K46170017		1-	
C 8017	CHIP CAP.	0.001uF	50V	B	GRM40B102M50PT	K22170805		1-	
C 8018	FILM CAP.	0.015uF	50V		AMZV0050K15300000200	K56170035		1-	
C 8019	CHIP CAP.	0.047uF	50V	F	GRM40F473Z50PT	K22171008		1-	
C 8020	CHIP CAP.	0.047uF	50V	F	GRM40F473Z50PT	K22171008		1-	
C 8021	AL.ELECTRO.CAP.	22uF	50V		50V220M5X11TR5	K46170022		1-	
C 8022	AL.ELECTRO.CAP.	1uF	50V		50V010M5X11TR5	K46170017		1-	
C 8023	CHIP CAP.	0.047uF	50V	F	GRM40F473Z50PT	K22171008		1-	
C 8024	CHIP CAP.	0.047uF	50V	F	GRM40F473Z50PT	K22171008		1-	
C 8025	CHIP CAP.	0.047uF	50V	F	GRM40F473Z50PT	K22171008		1-	
C 8026	CHIP CAP.	0.001uF	50V	B	GRM40B102M50PT	K22170805		1-	
C 8027	CHIP CAP.	0.047uF	50V	F	GRM40F473Z50PT	K22171008		1-	
C 8028	AL.ELECTRO.CAP.	1uF	50V		50V010M5X11TR5	K46170017		1-	
C 8029	FILM CAP.	0.0047uF	50V		AMZV0050K47200000200	K56170032		1-	
C 8030	CHIP CAP.	0.047uF	50V	F	GRM40F473Z50PT	K22171008		1-	
C 8031	CHIP CAP.	0.047uF	50V	F	GRM40F473Z50PT	K22171008		1-	
C 8032	AL.ELECTRO.CAP.	10uF	50V		50V100M5X11TR5	K46170021		1-	
C 8033	AL.ELECTRO.CAP.	22uF	50V		50V220M5X11TR5	K46170022		1-	
C 8034	CHIP CAP.	0.1uF	25V	B	GRM40B104M25PT	K22140811		1-	
C 8035	FILM CAP.	0.033uF	50V		AMZV0050K33300000200	K56170037		1-	
C 8036	AL.ELECTRO.CAP.	1uF	50V		50V010M5X11TR5	K46170017		1-	
C 8037	FILM CAP.	0.0047uF	50V		AMZV0050K47200000200	K56170032		1-	
C 8038	CHIP CAP.	0.001uF	50V	B	GRM40B102M50PT	K22170805		1-	
C 8039	CHIP CAP.	24pF	50V	CH	GRM40CH240J50PT	K22170220		1-	
C 8040	CHIP CAP.	0.001uF	50V	B	GRM40B102M50PT	K22170805		1-	
C 8041	AL.ELECTRO.CAP.	47uF	25V		25V470M5X11TR5	K46140004		1-	
C 8042	CHIP CAP.	0.047uF	50V	F	GRM40F473Z50PT	K22171008		1-	
C 8043	CHIP CAP.	100pF	50V	CH	GRM40CH101J50PT	K22170235		1-	
C 8044	CERAMIC CAP.	470pF	50V	B	DD104-979B471K50	K26171610		1-	
C 8045	CHIP CAP.	0.001uF	50V	B	GRM40B102M50PT	K22170805		1-	
C 8046	CHIP CAP.	0.047uF	50V	F	GRM40F473Z50PT	K22171008		1-	
C 8047	CHIP CAP.	0.01uF	50V	B	GRM40B103M50PT	K22170817		1-	
C 8048	CHIP CAP.	0.01uF	50V	B	GRM40B103M50PT	K22170817		1-	
C 8049	CHIP CAP.	100pF	50V	CH	GRM40CH101J50PT	K22170235		1-	
C 8050	CHIP CAP.	47pF	50V	CH	GRM40CH470J50PT	K22170227		1-	
C 8051	CHIP CAP.	0.047uF	50V	F	GRM40F473Z50PT	K22171008		1-	
C 8052	CHIP CAP.	0.047uF	50V	F	GRM40F473Z50PT	K22171008		1-	
C 8053	AL.ELECTRO.CAP.	1uF	50V		50V010M5X11TR5	K46170017		1-	
C 8054	CHIP CAP.	0.047uF	50V	F	GRM40F473Z50PT	K22171008		1-	
C 8055	CHIP CAP.	0.001uF	50V	B	GRM40B102M50PT	K22170805		1-	
C 8056	CHIP CAP.	0.047uF	50V	F	GRM40F473Z50PT	K22171008		1-	
C 8057	CHIP CAP.	0.047uF	50V	F	GRM40F473Z50PT	K22171008		1-	
C 8058	CHIP CAP.	0.047uF	50V	F	GRM40F473Z50PT	K22171008		1-	
C 8059	CHIP CAP.	0.01uF	50V	B	GRM40B103M50PT	K22170817		1-	
C 8060	CHIP CAP.	0.047uF	50V	F	GRM40F473Z50PT	K22171008		1-	
C 8061	CHIP CAP.	0.01uF	50V	B	GRM40B103M50PT	K22170817		1-	
C 8062	CHIP CAP.	0.01uF	50V	B	GRM40B103M50PT	K22170817		1-	
C 8063	CHIP CAP.	0.01uF	50V	B	GRM40B103M50PT	K22170817		1-	
C 8064	AL.ELECTRO.CAP.	47uF	50V		50V470M6X11TR5	K46170024		1-	
C 8065	CHIP CAP.	0.047uF	50V	F	GRM40F473Z50PT	K22171008		1-	

REF.	DESCRIPTION	VALUE	V/W	TOL.	MFR'S DESIG	YAESU P/N	VERS.	LOT.	LAY ADR
C 8066	CHIP CAP.	0.01uF	50V	B	GRM40B103M50PT	K22170817		1-	
C 8067	CHIP CAP.	0.047uF	50V	F	GRM40F473Z50PT	K22171008		1-	
C 8068	CHIP CAP.	0.001uF	50V	B	GRM40B102M50PT	K22170805		1-	
C 8069	CHIP CAP.	0.047uF	50V	F	GRM40F473Z50PT	K22171008		1-	
C 8070	CHIP CAP.	0.047uF	50V	F	GRM40F473Z50PT	K22171008		1-	
C 8071	CHIP CAP.	0.047uF	50V	F	GRM40F473Z50PT	K22171008		1-	
C 8072	CERAMIC CAP.	220pF	50V	B	DD104-979B221K50	K26171606		1-	
C 8073	CHIP CAP.	0.047uF	50V	F	GRM40F473Z50PT	K22171008		1-	
C 8074	CHIP CAP.	0.001uF	50V	B	GRM40B102M50PT	K22170805		1-	
C 8075	CHIP CAP.	0.001uF	50V	B	GRM40B102M50PT	K22170805		1-	
C 8076	AL.ELECTRO.CAP.	100uF	25V		25V101M6X11TR5	K46140005		1-	
C 8077	CHIP CAP.	0.01uF	50V	B	GRM40B103M50PT	K22170817		1-	
C 8078	CHIP CAP.	0.01uF	50V	B	GRM40B103M50PT	K22170817		1-	
C 8079	AL.ELECTRO.CAP.	10uF	50V		50V100M5X11TR5	K46170021		1-	
C 8080	CHIP CAP.	0.047uF	50V	F	GRM40F473Z50PT	K22171008		1-	
C 8081	CHIP CAP.	0.047uF	50V	F	GRM40F473Z50PT	K22171008		1-	
C 8082	CHIP CAP.	0.01uF	50V	B	GRM40B103M50PT	K22170817		1-	
C 8084	CHIP CAP.	0.01uF	50V	B	GRM40B103M50PT	K22170817		1-	
C 8085	CHIP CAP.	0.047uF	50V	F	GRM40F473Z50PT	K22171008		1-	
C 8086	AL.ELECTRO.CAP.	47uF	25V		25V470M5X11TR5	K46140004		1-	
C 8087	CHIP CAP.	0.5pF	50V	CK	GRM40CK0R5C50PT	K22170201		1-	
C 8088	CHIP CAP.	24pF	50V	CH	GRM40CH240J50PT	K22170220		1-	
C 8089	CHIP CAP.	22pF	50V	CH	GRM40CH220J50PT	K22170219		1-	
C 8090	CHIP CAP.	0.01uF	50V	B	GRM40B103M50PT	K22170817		1-	
C 8091	CHIP CAP.	1pF	50V	CK	GRM40CK010C50PT	K22170202		1-	
C 8092	CHIP CAP.	0.01uF	50V	B	GRM40B103M50PT	K22170817		1-	
C 8093	CHIP CAP.	0.01uF	50V	B	GRM40B103M50PT	K22170817		1-	
C 8094	CHIP CAP.	0.01uF	50V	B	GRM40B103M50PT	K22170817		1-	
C 8096	CHIP CAP.	5pF	50V	CH	GRM40CH050C50PT	K22170206		1-	
C 8097	CHIP CAP.	0.001uF	50V	B	GRM40B102M50PT	K22170805		1-	
C 8098	CHIP CAP.	56pF	50V	CH	GRM40CH560J50PT	K22170229		1-	
C 8099	CHIP CAP.	12pF	50V	CH	GRM40CH120J50PT	K22170213		1-	
C 8100	CHIP CAP.	10pF	50V	CH	GRM40CH100D50PT	K22170211		1-	
C 8101	CHIP CAP.	0.01uF	50V	B	GRM40B103M50PT	K22170817		1-	
C 8102	CHIP CAP.	0.01uF	50V	B	GRM40B103M50PT	K22170817		1-	
C 8103	CHIP CAP.	0.001uF	50V	B	GRM40B102M50PT	K22170805		1-	
C 8104	CHIP CAP.	47pF	50V	CH	GRM40CH470J50PT	K22170227		1-	
C 8105	CHIP CAP.	47pF	50V	CH	GRM40CH470J50PT	K22170227		1-	
C 8106	CHIP CAP.	27pF	50V	CH	GRM40CH270J50PT	K22170221		1-	
C 8107	CHIP CAP.	0.01uF	50V	B	GRM40B103M50PT	K22170817		1-	
C 8108	CHIP CAP.	0.001uF	50V	B	GRM40B102M50PT	K22170805		1-	
C 8109	CHIP CAP.	18pF	50V	CH	GRM40CH180J50PT	K22170217		1-	
C 8110	CHIP CAP.	0.047uF	50V	F	GRM40F473Z50PT	K22171008		1-	
C 8111	CHIP CAP.	0.047uF	50V	F	GRM40F473Z50PT	K22171008		1-	
C 8112	CHIP CAP.	0.001uF	50V	B	GRM40B102M50PT	K22170805		1-	
C 8113	CHIP CAP.	1pF	50V	CK	GRM40CK010C50PT	K22170202		1-	
C 8114	CHIP CAP.	0.01uF	50V	B	GRM40B103M50PT	K22170817		1-	
C 8115	CHIP CAP.	0.01uF	50V	B	GRM40B103M50PT	K22170817		1-	
C 8116	CHIP CAP.	1pF	50V	CK	GRM40CK010C50PT	K22170202		1-	
C 8117	CHIP CAP.	1pF	50V	CK	GRM40CK010C50PT	K22170202		1-	
C 8118	CHIP CAP.	0.01uF	50V	B	GRM40B103M50PT	K22170817		1-	
C 8119	CHIP CAP.	33pF	50V	CH	GRM40CH330J50PT	K22170223		1-	
C 8120	CHIP CAP.	0.001uF	50V	B	GRM40B102M50PT	K22170805		1-	
C 8121	CHIP CAP.	18pF	50V	CH	GRM40CH180J50PT	K22170217		1-	
C 8122	CHIP CAP.	39pF	50V	CH	GRM40CH390J50PT	K22170225		1-	
C 8123	CHIP CAP.	0.01uF	50V	B	GRM40B103M50PT	K22170817		1-	
C 8124	CHIP CAP.	10pF	50V	CH	GRM40CH100D50PT	K22170211		1-	
C 8125	CHIP CAP.	0.01uF	50V	B	GRM40B103M50PT	K22170817		1-	
C 8126	CHIP CAP.	0.01uF	50V	B	GRM40B103M50PT	K22170817		1-	
C 8127	CHIP CAP.	0.047uF	50V	F	GRM40F473Z50PT	K22171008		1-	
C 8128	CHIP CAP.	0.047uF	50V	F	GRM40F473Z50PT	K22171008		1-	
C 8129	CHIP CAP.	10pF	50V	CH	GRM40CH100D50PT	K22170211		1-	
C 8130	CHIP CAP.	0.01uF	50V	B	GRM40B103M50PT	K22170817		1-	
C 8131	CHIP CAP.	0.01uF	50V	B	GRM40B103M50PT	K22170817		1-	
C 8132	CHIP CAP.	0.01uF	50V	B	GRM40B103M50PT	K22170817		1-	
C 8133	CHIP CAP.	0.01uF	50V	B	GRM40B103M50PT	K22170817		1-	
C 8134	CHIP CAP.	1pF	50V	CK	GRM40CK010C50PT	K22170202		1-	
C 8135	CHIP CAP.	0.01uF	50V	B	GRM40B103M50PT	K22170817		1-	

RX-2 Unit

Parts List

REF.	DESCRIPTION	VALUE	V/W	TOL.	MFR'S DESIG	YAESU P/N	VERS.	LOT.	LAYADR
C 8136	CHIP CAP.	0.01uF	50V	B	GRM40B103M50PT	K22170817		1-	
C 8137	CHIP CAP.	100pF	50V	CH	GRM40CH101J50PT	K22170235		1-	
C 8138	CHIP CAP.	15pF	50V	CH	GRM40CH150J50PT	K22170215		1-	
C 8139	CHIP CAP.	0.01uF	50V	B	GRM40B103M50PT	K22170817		1-	
C 8140	AL.ELECTRO.CAP.	100uF	25V		25V101M6X11TR5	K46140005		1-	
C 8141	CHIP CAP.	0.047uF	50V	F	GRM40F473Z50PT	K22171008		1-	
C 8142	CHIP CAP.	0.047uF	50V	F	GRM40F473Z50PT	K22171008		1-	
C 8143	CHIP CAP.	0.047uF	50V	F	GRM40F473Z50PT	K22171008		1-	
C 8144	CHIP CAP.	0.047uF	50V	F	GRM40F473Z50PT	K22171008		1-	
C 8145	CHIP CAP.	0.01uF	50V	B	GRM40B103M50PT	K22170817		1-	
C 8146	CHIP CAP.	0.01uF	50V	B	GRM40B103M50PT	K22170817		1-	
C 8147	CHIP CAP.	0.047uF	50V	F	GRM40F473Z50PT	K22171008		1-	
C 8148	CHIP CAP.	0.047uF	50V	F	GRM40F473Z50PT	K22171008		1-	
C 8149	CHIP CAP.	18pF	50V	CH	GRM40CH180J50PT	K22170217		1-	
C 8150	CHIP CAP.	39pF	50V	CH	GRM40CH390J50PT	K22170225		1-	
C 8151	CHIP CAP.	0.01uF	50V	B	GRM40B103M50PT	K22170817		1-	
C 8152	CHIP CAP.	18pF	50V	CH	GRM40CH180J50PT	K22170217		1-	
C 8153	CHIP CAP.	5pF	50V	CH	GRM40CH050C50PT	K22170206		1-	
C 8154	CHIP CAP.	0.047uF	50V	F	GRM40F473Z50PT	K22171008		1-	
C 8156	CHIP CAP.	0.01uF	50V	B	GRM40B103M50PT	K22170817		1-	
C 8157	CHIP CAP.	3pF	50V	CJ	GRM40CJ030C50PT	K22170204		1-	
C 8158	CHIP CAP.	9pF	50V	CH	GRM40CH090D50PT	K22170210		1-	
C 8159	CHIP CAP.	12pF	50V	CH	GRM40CH120J50PT	K22170213		1-	
C 8160	CHIP CAP.	9pF	50V	CH	GRM40CH090D50PT	K22170210		1-	
C 8161	CHIP CAP.	1pF	50V	CK	GRM40CK010C50PT	K22170202		1-	
C 8162	CHIP CAP.	0.047uF	50V	F	GRM40F473Z50PT	K22171008		1-	
C 8163	CHIP CAP.	10pF	50V	CH	GRM40CH100D50PT	K22170211		1-	
C 8164	CHIP CAP.	68pF	50V	CH	GRM40CH680J50PT	K22170231		1-	
C 8165	CHIP CAP.	100pF	50V	CH	GRM40CH101J50PT	K22170235		1-	
C 8166	CHIP CAP.	68pF	50V	CH	GRM40CH680J50PT	K22170231		1-	
C 8167	CHIP CAP.	68pF	50V	CH	GRM40CH680J50PT	K22170231		1-	
C 8168	CHIP CAP.	12pF	50V	CH	GRM40CH120J50PT	K22170213		1-	
C 8169	CHIP CAP.	18pF	50V	CH	GRM40CH180J50PT	K22170217		1-	
C 8170	CHIP CAP.	15pF	50V	CH	GRM40CH150J50PT	K22170215		1-	
C 8171	CHIP CAP.	15pF	50V	CH	GRM40CH150J50PT	K22170215		1-	
C 8172	CHIP CAP.	22pF	50V	CH	GRM40CH220J50PT	K22170219		1-	
C 8173	CHIP CAP.	15pF	50V	CH	GRM40CH150J50PT	K22170215		1-	
C 8174	CHIP CAP.	0.047uF	50V	F	GRM40F473Z50PT	K22171008		1-	
C 8175	CHIP CAP.	15pF	50V	CH	GRM40CH150J50PT	K22170215		1-	
C 8176	CHIP CAP.	0.01uF	50V	B	GRM40B103M50PT	K22170817		1-	
C 8177	CHIP CAP.	0.01uF	50V	B	GRM40B103M50PT	K22170817		1-	
C 8178	AL.ELECTRO.CAP.	100uF	25V		25V101M6X11TR5	K46140005		1-	
C 8179	AL.ELECTRO.CAP.	1uF	50V		50V010M5X11TR5	K46170017		1-	
C 8180	CHIP CAP.	0.047uF	50V	F	GRM40F473Z50PT	K22171008		1-	
C 8181	AL.ELECTRO.CAP.	10uF	50V		50V100M5X11TR5	K46170021		1-	
C 8182	FILM CAP.	0.15uF	50V		AMZ0050K15400000000	K50170086		1-	
C 8183	CHIP CAP.	0.047uF	50V	F	GRM40F473Z50PT	K22171008		1-	
C 8184	CHIP CAP.	0.047uF	50V	F	GRM40F473Z50PT	K22171008		1-	
C 8185	CHIP CAP.	0.01uF	50V	B	GRM40B103M50PT	K22170817		1-	
C 8186	CHIP CAP.	0.001uF	50V	B	GRM40B102M50PT	K22170805		1-	
C 8187	CHIP CAP.	0.01uF	50V	B	GRM40B103M50PT	K22170817		1-	
C 8188	CHIP CAP.	18pF	50V	CH	GRM40CH180J50PT	K22170217		1-	
C 8189	CHIP CAP.	27pF	50V	CH	GRM40CH270J50PT	K22170221		1-	
C 8190	CHIP CAP.	0.01uF	50V	B	GRM40B103M50PT	K22170817		1-	
C 8191	CHIP CAP.	47pF	50V	CH	GRM40CH470J50PT	K22170227		1-	
C 8193	CHIP CAP.	10pF	50V	CH	GRM40CH100D50PT	K22170211		1-	
C 8194	CHIP CAP.	0.01uF	50V	B	GRM40B103M50PT	K22170817		1-	
C 8195	AL.ELECTRO.CAP.	47uF	25V		25V470M5X11TR5	K46140004		1-	
C 8196	CHIP CAP.	10pF	50V	CH	GRM40CH100D50PT	K22170211		1-	
C 8197	CHIP CAP.	15pF	50V	CH	GRM40CH150J50PT	K22170215		1-	
C 8198	CHIP CAP.	0.01uF	50V	B	GRM40B103M50PT	K22170817		1-	
C 8199	CHIP CAP.	0.01uF	50V	B	GRM40B103M50PT	K22170817		1-	
C 8200	CHIP CAP.	0.01uF	50V	B	GRM40B103M50PT	K22170817		1-	
C 8201	CHIP CAP.	0.01uF	50V	B	GRM40B103M50PT	K22170817		1-	
C 8202	CHIP CAP.	47pF	50V	CH	GRM40CH470J50PT	K22170227		1-	
C 8203	CHIP CAP.	0.01uF	50V	B	GRM40B103M50PT	K22170817		1-	
C 8204	CHIP CAP.	0.01uF	50V	B	GRM40B103M50PT	K22170817		1-	
C 8205	CHIP CAP.	0.01uF	50V	B	GRM40B103M50PT	K22170817		1-	

RX-2 Unit

Parts List

REF.	DESCRIPTION	VALUE	V/W	TOL.	MFR'S DESIG	YAESU P/N	VERS.	LOT.	LAY ADR
C 8206	CHIP CAP.	0.01uF	50V	B	GRM40B103M50PT	K22170817		1-	
C 8207	CHIP CAP.	0.01uF	50V	B	GRM40B103M50PT	K22170817		1-	
C 8208	CHIP CAP.	0.01uF	50V	B	GRM40B103M50PT	K22170817		1-	
C 8209	CHIP CAP.	1pF	50V	CK	GRM40CK010C50PT	K22170202		1-	
C 8210	CHIP CAP.	8pF	50V	CH	GRM40CH080D50PT	K22170209		1-	
C 8211	CHIP CAP.	5pF	50V	CH	GRM40CH050C50PT	K22170206		1-	
C 8212	CHIP CAP.	5pF	50V	CH	GRM40CH050C50PT	K22170206		1-	
C 8213	CHIP CAP.	0.01uF	50V	B	GRM40B103M50PT	K22170817		1-	
C 8214	CHIP CAP.	0.047uF	50V	F	GRM40F473Z50PT	K22171008		1-	
C 8216	CHIP CAP.	330pF	50V	CH	GRM40CH331J50PT	K22170247		1-	
C 8217	CHIP CAP.	0.01uF	50V	B	GRM40B103M50PT	K22170817		1-	
C 8218	CHIP CAP.	0.01uF	50V	B	GRM40B103M50PT	K22170817		1-	
C 8219	CHIP CAP.	0.01uF	50V	B	GRM40B103M50PT	K22170817		1-	
C 8220	CHIP CAP.	0.01uF	50V	B	GRM40B103M50PT	K22170817		1-	
C 8221	CHIP CAP.	0.01uF	50V	B	GRM40B103M50PT	K22170817		1-	
C 8223	CHIP CAP.	0.0022uF	50V	B	GRM40B222M50PT	K22170809		1-	
C 8225	CERAMIC CAP.	150pF	50V	B	DD104-979B151K50	K26171604		1-	
C 8226	CHIP CAP.	220pF	50V	CH	GRM40CH221J50PT	K22170243		1-	
C 8227	CHIP CAP.	0.01uF	50V	B	GRM40B103M50PT	K22170817		1-	
C 8228	CHIP CAP.	22pF	50V	CH	GRM40CH220J50PT	K22170219		1-	
C 8229	CHIP CAP.	150pF	50V	CH	GRM40CH151J50PT	K22170239		1-	
C 8230	CHIP CAP.	150pF	50V	CH	GRM40CH151J50PT	K22170239		1-	
C 8231	CHIP CAP.	0.01uF	50V	B	GRM40B103M50PT	K22170817		1-	
C 8232	CHIP CAP.	0.047uF	50V	F	GRM40F473Z50PT	K22171008		1-	
C 8233	CHIP CAP.	0.047uF	50V	F	GRM40F473Z50PT	K22171008		1-	
C 8234	CHIP CAP.	0.047uF	50V	F	GRM40F473Z50PT	K22171008		1-	
C 8235	CHIP CAP.	0.047uF	50V	F	GRM40F473Z50PT	K22171008		1-	
C 8237	CHIP CAP.	0.1uF	25V	B	GRM40B104M25PT	K22140811		30-	
C 8238	CHIP CAP.	0.01uF	50V	B	GRM40B103M50PT	K22170817		30-	
C 8239	CHIP CAP.	100pF	50V	CH	GRM40CH101J50PT	K22170235		30-	
C 8241	CHIP CAP.	0.1uF	25V	B	GRM40B104M25PT	K22140811		30-	
C 8242	CHIP CAP.	0.001uF	50V	B	GRM40B102M50PT	K22170805		30-	
C 8243	CHIP CAP.	0.001uF	50V	B	GRM40B102M50PT	K22170805		30-	
C 8244	CHIP CAP.	0.0047uF	50V	B	GRM40B472M50PT	K22170813		30-	
CD8001	CERAMIC DISC				CDB455C16	H7900740		1-	
CD8001	CERAMIC DISC				CDBM455C7	H7900480		30-	
CF8001	CERAMIC FILTER				CFWS455G	H3900507		1-	
CF8002	CERAMIC FILTER				CFJ-455K13	H3900290		1-	
CF8003	CERAMIC FILTER				CFWS455HT	H3900508		1-	
CF8004	CERAMIC FILTER				SFT5.57MA	H3900403		1-	
D 8001	DIODE				DAN202K T146	G2070182		1-	c2
D 8002	DIODE				DAN202K T146	G2070182		1-	c2
D 8003	DIODE				1SS270TJ	G2060004		1-	E2
D 8003	DIODE				1SS133 T-77	G2060001		27-	E2
D 8004	DIODE				1SS270TJ	G2060004		1-	E3
D 8004	DIODE				1SS133 T-77	G2060001		27-	E3
D 8005	DIODE				1SS270TJ	G2060004		1-	E1
D 8005	DIODE				1SS133 T-77	G2060001		27-	E1
D 8006	DIODE				1SS198TJ	G2060011		1-	E4
D 8007	DIODE				1SS198TJ	G2060011		1-	E4
D 8008	DIODE				1SS270TJ	G2060004		1-	E3
D 8008	DIODE				1SS133 T-77	G2060001		27-	E3
D 8009	DIODE				1SS270TJ	G2060004		1-	E3
D 8009	DIODE				1SS133 T-77	G2060001		27-	E3
D 8010	DIODE				1SS270TJ	G2060004		1-	E3
D 8010	DIODE				1SS133 T-77	G2060001		27-	E3
D 8011	DIODE				1SS270TJ	G2060004		1-	E3
D 8011	DIODE				1SS133 T-77	G2060001		27-	E3
D 8012	DIODE				1SS270TJ	G2060004		1-	G3
D 8012	DIODE				1SS133 T-77	G2060001		27-	G3
D 8013	DIODE				1SS270TJ	G2060004		1-	E3
D 8013	DIODE				1SS133 T-77	G2060001		27-	E3
D 8014	DIODE				1SS198TJ	G2060011		1-	G2
D 8015	DIODE				1SS270TJ	G2060004		1-	E3
D 8015	DIODE				1SS133 T-77	G2060001		27-	E3
D 8016	DIODE				1SS270TJ	G2060004		1-	G3
D 8016	DIODE				1SS133 T-77	G2060001		27-	G3
D 8017	DIODE				1SS198TJ	G2060011		1-	G2

RX-2 Unit

Parts List

REF.	DESCRIPTION	VALUE	V/W	TOL.	MFR'S DESIG	YAESU P/N	VERS.	LOT.	LAY ADR
D 8018	DIODE				1SS198TJ	G2060011		1-	G2
D 8019	DIODE				1SS53-TB	G2050008		1-	B1
D 8020	DIODE				DAN202K T146	G2070182		1-	c3
D 8021	DIODE				HVU306A5TRF	G2070132		1-	h1
D 8022	DIODE				1SS53-TB	G2050008		1-	B1
D 8023	DIODE				1SS270TJ	G2060004		1-	G3
D 8023	DIODE				1SS133 T-77	G2060001		27-	G3
D 8024	DIODE				HVU306A5TRF	G2070132		1-	h2
D 8025	DIODE				1SS53-TB	G2050008		1-	B2
D 8026	DIODE				DAN202K T146	G2070182		1-	c1
D 8027	DIODE				HVU306A5TRF	G2070132		1-	h2
D 8028	DIODE				1SS270TJ	G2060004		1-	E3
D 8028	DIODE				1SS133 T-77	G2060001		27-	E3
D 8029	DIODE				1SS53-TB	G2050008		1-	B2
D 8030	DIODE				1SS270TJ	G2060004		1-	E2
D 8030	DIODE				1SS133 T-77	G2060001		27-	E2
D 8031	DIODE				HVU306A5TRF	G2070132		1-	h2
D 8032	DIODE				02CZ5.1Y TE85R	G2070062		30-	h2
J 8001	CONNECTOR				SC25-06WS	P0090625		1-	
J 8002	CONNECTOR				TMP-J01X-A2	P1090255		1-	
J 8003	CONNECTOR				16FMZ-BT	P1090902		1-	
J 8004	CONNECTOR				SC25-02WS	P0090621		1-	
J 8005	CONNECTOR				3022-04B	P0090523		1-	
J 8006	CONNECTOR				3022-04B	P0090523		1-	
L 8001	M.RFC	1mH			LAL03VB102K	L1790164		1-	
L 8002	M.RFC	1mH			LAL03VB102K	L1790164		1-	
L 8004	M.RFC	100uH			LAP02TA101K	L1790070		1-	
L 8005	COIL A1				3.5T4.0D0.6UEW R	L0021824A		1-	
L 8006	COIL A1				5.5T4.0D0.6UEW R	L0021826A		1-	
L 8007	COIL 10RF	50MHz			50.0M	L0021599		1-	
L 8008	M.RFC	3.3uH			LAP02TA3R3K	L1790052		1-	
L 8010	COIL 10RF				0.42U	L0021399		1-	
L 8011	M.RFC	3.3uH			LAP02TA3R3K	L1790052		1-	
L 8012	M.RFC	18uH			LAP02TA180K	L1790061		1-	
L 8013	M.RFC	15uH			LAP02TA150K	L1790060		1-	
L 8014	M.RFC	100uH			LAP02TA101K	L1790070		1-	
L 8015	M.RFC	1.8uH			LAP02TA1R8K	L1790049		1-	
L 8016	M.RFC	1.5uH			LAP02TA1R5K	L1790048		1-	
L 8017	M.RFC	1uH			LAP02TA1R0K	L1790046		1-	
L 8018	M.RFC	1.2uH			LAP02TA1R2K	L1790047		1-	
L 8019	M.RFC	1.5uH			LAP02TA1R5K	L1790048		1-	
L 8020	COIL 10RF				0.36U	L0021400		1-	
L 8021	M.RFC	2.7uH			LAP02TA2R7K	L1790051		1-	
L 8022	M.RFC	100uH			LAP02TA101K	L1790070		1-	
L 8024	COIL 10RF				0.28U	L0021401		1-	
L 8025	M.RFC	2.7uH			LAP02TA2R7K	L1790051		1-	
L 8026	M.RFC	100uH			LAP02TA101K	L1790070		1-	
L 8027	M.RFC	100uH			LAP02TA101K	L1790070		1-	
L 8028	M.RFC	100uH			LAP02TA101K	L1790070		1-	
L 8029	M.RFC	10uH			LAP02TA100K	L1790058		1-	
L 8030	M.RFC	0.22uH			LAP02TAR22K	L1790038		1-	
Q 8001	FET				2SK302GR TE85R	G3803027G		1-	d3
Q 8002	FET				2SK160-T2B K6	G3801607F		1-	c1
Q 8003	TRANSISTOR				2SC4047-TA	G3340477		1-	c3
Q 8003	TRANSISTOR				UN2214-(TX)	G3070206		8-	c3
Q 8004	TRANSISTOR				2SC2812L6-TA	G3328127F		1-	c4
Q 8004	TRANSISTOR				2SC2812NL6-TB	G3328128F		8-	c4
Q 8005	IC				M5218AFP-600C	G1091607		1-	b2
Q 8005	IC				NJM4558M(Te1)	G1093334		5-	b2
Q 8006	IC				UPD4052BG-T2	G1091033		1-	c1
Q 8007	IC				BU4094BCF-E2	G1092684		1-	e1
Q 8008	FET				3SK131-T2B V12	G4801317B		1-	d4
Q 8009	FET				2SK302GR TE85R	G3803027G		1-	c3
Q 8010	TRANSISTOR				2SC2812L6-TA	G3328127F		1-	b2
Q 8010	TRANSISTOR				2SC2812NL6-TB	G3328128F		8-	b2
Q 8011	IC				M5223AFP 600C	G1092955		1-	d2
Q 8012	IC				MC3372ML	G1091108		1-	b1
Q 8012	IC				TA31136F(TAPE)	G1093446		30-	b1

RX-2 Unit

Parts List

REF.	DESCRIPTION	VALUE	V/W	TOL.	MFR'S DESIG	YAESU P/N	VERS.	LOT.	LAYADR
Q 8013	IC				M5218AFP-600C	G1091607		1-	d3
Q 8013	IC				NJM4558M(TE1)	G1093334		5-	d3
Q 8014	TRANSISTOR				2SA1563-TB	G3115638		1-	c1
Q 8015	TRANSISTOR				2SC2812L6-TA	G3328127F		1-	d3
Q 8015	TRANSISTOR				2SC2812NL6-TB	G3328128F		8-	d3
Q 8016	TRANSISTOR				2SC4047-TA	G3340477		1-	d3
Q 8016	TRANSISTOR				UN2214-(TX)	G3070206		8-	d3
Q 8017	TRANSISTOR				2SC2812L6-TA	G3328127F		1-	a1
Q 8017	TRANSISTOR				2SC2812NL6-TB	G3328128F		8-	a1
Q 8018	TRANSISTOR				2SC4047-TA	G3340477		1-	d4
Q 8018	TRANSISTOR				UN2214-(TX)	G3070206		8-	d4
Q 8019	IC				BU4094BCF-E2	G1092684		1-	f1
Q 8020	FET				2SK160-T2B K6	G3801607F		1-	b2
Q 8021	TRANSISTOR				2SC2812L6-TA	G3328127F		1-	a3
Q 8021	TRANSISTOR				2SC2812NL6-TB	G3328128F		8-	a3
Q 8022	FET				SST310-T1	G4070009		1-	g4
Q 8023	FET				2SK302GR TE85R	G3803027G		1-	e4
Q 8024	FET				3SK131-T2B V12	G4801317B		1-	f4
Q 8025	TRANSISTOR				2SC2812L6-TA	G3328127F		1-	b2
Q 8025	TRANSISTOR				2SC2812NL6-TB	G3328128F		8-	b2
Q 8026	FET				2SK302GR TE85R	G3803027G		1-	e4
Q 8027	FET				SST310-T1	G4070009		1-	g3
Q 8028	TRANSISTOR				2SC4047-TA	G3340477		1-	a2
Q 8028	TRANSISTOR				UN2214-(TX)	G3070206		8-	a2
Q 8029	TRANSISTOR				2SC2812L6-TA	G3328127F		1-	a2
Q 8029	TRANSISTOR				2SC2812NL6-TB	G3328128F		8-	a2
Q 8030	TRANSISTOR				2SC4047-TA	G3340477		1-	b3
Q 8030	TRANSISTOR				UN2214-(TX)	G3070206		8-	b3
Q 8031	IC				TA78L05F TE12R	G1091014		1-	f1
Q 8032	TRANSISTOR				2SA1563-TB	G3115638		1-	c2
Q 8033	TRANSISTOR				2SC4047-TA	G3340477		1-	a3
Q 8033	TRANSISTOR				UN2214-(TX)	G3070206		8-	a3
Q 8034	FET				2SK210BL TE85R	G3802107B		1-	g1
Q 8035	TRANSISTOR				2SC2714YTE85R	G3327147Y		1-	g3
Q 8036	TRANSISTOR				2SC2053-101	G3320530		1-	A3
Q 8037	TRANSISTOR				2SC2714YTE85R	G3327147Y		1-	f3
Q 8038	IC				SN16913P	G1090012		1-	C3
Q 8039	TRANSISTOR				2SC4047-TA	G3340477		1-	b3
Q 8039	TRANSISTOR				UN2214-(TX)	G3070206		8-	b3
Q 8040	TRANSISTOR				2SC4047-TA	G3340477		1-	g1
Q 8040	TRANSISTOR				UN2214-(TX)	G3070206		8-	g1
Q 8041	FET				2SK210GR TE85R	G3802107G		1-	g3
Q 8042	TRANSISTOR				2SC2714YTE85R	G3327147Y		1-	f3
Q 8043	IC				UPC1037H	G1090101		1-	B3
Q 8044	TRANSISTOR				2SC2714YTE85R	G3327147Y		1-	e3
Q 8045	TRANSISTOR				2SC2714YTE85R	G3327147Y		1-	e3
Q 8046	FET				2SK210GR TE85R	G3802107G		1-	e3
Q 8047	FET				2SK210BL TE85R	G3802107B		1-	g2
Q 8048	FET				3SK131-T2B V12	G4801317B		1-	a3
Q 8049	FET				3SK131-T2B V12	G4801317B		1-	a2
Q 8050	TRANSISTOR				2SC4047-TA	G3340477		1-	g2
Q 8050	TRANSISTOR				UN2214-(TX)	G3070206		8-	g2
Q 8051	FET				2SK210BL TE85R	G3802107B		1-	g2
Q 8052	TRANSISTOR				2SC2714YTE85R	G3327147Y		1-	f2
Q 8053	FET				2SK210GR TE85R	G3802107G		1-	f2
Q 8054	IC				TC74HC74AF EL	G1091446		1-	d1
Q 8055	IC				SN16913P	G1090012		1-	C2
Q 8056	TRANSISTOR				2SC4047-TA	G3340477		1-	g2
Q 8056	TRANSISTOR				UN2214-(TX)	G3070206		8-	g2
Q 8057	IC				UPC1037H	G1090101		1-	G1
Q 8058	FET				2SK210BL TE85R	G3802107B		1-	g2
Q 8059	FET				2SK208Y TE85R	G3802087Y		1-	f1
Q 8060	TRANSISTOR				2SC2812L6-TA	G3328127F		1-	d1
Q 8060	TRANSISTOR				2SC2812NL6-TB	G3328128F		8-	d1
Q 8061	IC				MB87086APF-G-BND-TF	G1091419		1-	f2
Q 8062	TRANSISTOR				2SC732TMBL	G3307320B		1-	B2
Q 8063	TRANSISTOR				2SC4047-TA	G3340477		1-	g2
Q 8063	TRANSISTOR				UN2214-(TX)	G3070206		8-	g2

RX-2 Unit

Parts List

REF.	DESCRIPTION	VALUE	V/W	TOL.	MFR'S DESIG	YAESU P/N	VERS.	LOT.	LAY ADR
Q 8064	TRANSISTOR				2SC2812L6-TA	G3328127F		1-	e2
Q 8064	TRANSISTOR				2SC2812NL6-TB	G3328128F		8-	e2
Q 8065	TRANSISTOR				2SC2812L6-TA	G3328127F		1-	e2
Q 8065	TRANSISTOR				2SC2812NL6-TB	G3328128F		8-	e2
Q 8066	TRANSISTOR				2SC2812L6-TA	G3328127F		1-	e2
Q 8066	TRANSISTOR				2SC2812NL6-TB	G3328128F		8-	e2
Q 8067	TRANSISTOR				2SC4047-TA	G3340477		1-	b2
Q 8067	TRANSISTOR				UN2214-(TX)	G3070206		8-	b2
Q 8068	TRANSISTOR				2SC4047-TA	G3340477		1-	c3
Q 8068	TRANSISTOR				UN2214-(TX)	G3070206		8-	c3
Q 8087	TRANSISTOR				FA1A4P-T2B	G3070006		30-	
R 8001	CHIP RES.	100	1/10W	5%	RMC1/10T 101J	J24205101		1-	
R 8002	CHIP RES.	4.7k	1/10W	5%	RMC1/10T 472J	J24205472		1-	
R 8003	CHIP RES.	47k	1/10W	5%	RMC1/10T 473J	J24205473		1-	
R 8004	CHIP RES.	47k	1/10W	5%	RMC1/10T 473J	J24205473		1-	
R 8005	CHIP RES.	47k	1/10W	5%	RMC1/10T 473J	J24205473		1-	
R 8006	CHIP RES.	100	1/10W	5%	RMC1/10T 101J	J24205101		1-	
R 8007	CHIP RES.	100k	1/10W	5%	RMC1/10T 104J	J24205104		1-	
R 8008	CHIP RES.	1k	1/10W	5%	RMC1/10T 102J	J24205102		1-	
R 8009	CHIP RES.	10k	1/10W	5%	RMC1/10T 103J	J24205103		1-	
R 8010	CHIP RES.	47k	1/10W	5%	RMC1/10T 473J	J24205473		1-	
R 8011	CARBON FILM RES.	1.5k	1/6W	5%	RD16TPJ152 1.5K	J07225152		1-	
R 8012	CHIP RES.	100k	1/10W	5%	RMC1/10T 104J	J24205104		1-	
R 8013	CHIP RES.	100	1/10W	5%	RMC1/10T 101J	J24205101		1-	
R 8014	CHIP RES.	100k	1/10W	5%	RMC1/10T 104J	J24205104		1-	
R 8015	CHIP RES.	47k	1/10W	5%	RMC1/10T 473J	J24205473		1-	
R 8016	CHIP RES.	100k	1/10W	5%	RMC1/10T 104J	J24205104		1-	
R 8017	CHIP RES.	47k	1/10W	5%	RMC1/10T 473J	J24205473		1-	
R 8018	CHIP RES.	100k	1/10W	5%	RMC1/10T 104J	J24205104		1-	
R 8019	CHIP RES.	1k	1/10W	5%	RMC1/10T 102J	J24205102		1-	
R 8020	CHIP RES.	4.7k	1/10W	5%	RMC1/10T 472J	J24205472		1-	
R 8021	CARBON FILM RES.	6.8k	1/6W	5%	RD16TPJ682 6.8K	J07225682		1-	
R 8022	CHIP RES.	150k	1/10W	5%	RMC1/10T 154J	J24205154		1-	
R 8023	CHIP RES.	1k	1/10W	5%	RMC1/10T 102J	J24205102		1-	
R 8024	CARBON FILM RES.	330k	1/6W	5%	RD16TPJ334 330K	J07225334		1-	
R 8025	CHIP RES.	10k	1/10W	5%	RMC1/10T 103J	J24205103		1-	
R 8026	CHIP RES.	15k	1/10W	5%	RMC1/10T 153J	J24205153		1-	
R 8027	CHIP RES.	100k	1/10W	5%	RMC1/10T 104J	J24205104		1-	
R 8028	CHIP RES.	68k	1/10W	5%	RMC1/10T 683J	J24205683		1-	
R 8029	CHIP RES.	3.3k	1/10W	5%	RMC1/10T 332J	J24205332		1-	
R 8030	CHIP RES.	2.2k	1/10W	5%	RMC1/10T 222J	J24205222		1-	
R 8031	CHIP RES.	4.7k	1/10W	5%	RMC1/10T 472J	J24205472		1-	
R 8032	CHIP RES.	220k	1/10W	5%	RMC1/10T 224J	J24205224		1-	
R 8033	CHIP RES.	100	1/10W	5%	RMC1/10T 101J	J24205101		1-	
R 8034	CHIP RES.	1.5k	1/10W	5%	RMC1/10T 152J	J24205152		1-	
R 8035	CHIP RES.	68k	1/10W	5%	RMC1/10T 683J	J24205683		1-	
R 8036	CHIP RES.	10k	1/10W	5%	RMC1/10T 103J	J24205103		1-	
R 8037	CHIP RES.	100	1/10W	5%	RMC1/10T 101J	J24205101		1-	
R 8037	CHIP RES.	220	1/10W	5%	RMC1/10T 221J	J24205221		30-	
R 8038	CHIP RES.	68k	1/10W	5%	RMC1/10T 683J	J24205683		1-	
R 8039	CHIP RES.	3.3k	1/10W	5%	RMC1/10T 332J	J24205332		1-	
R 8040	CHIP RES.	1k	1/10W	5%	RMC1/10T 102J	J24205102		1-	
R 8041	CHIP RES.	68k	1/10W	0.50%	RR1220P-683-D-T5	J24209215		1-	
R 8042	CHIP RES.	100k	1/10W	5%	RMC1/10T 104J	J24205104		1-	
R 8043	CHIP RES.	330	1/10W	5%	RMC1/10T 331J	J24205331		1-	
R 8044	CHIP RES.	1k	1/10W	5%	RMC1/10T 102J	J24205102		1-	
R 8045	CHIP RES.	220k	1/10W	0.50%	RR1220R-224-D-T5	J24209227		1-	
R 8046	CHIP RES.	10k	1/10W	5%	RMC1/10T 103J	J24205103		1-	
R 8047	CHIP RES.	10k	1/10W	5%	RMC1/10T 103J	J24205103		1-	
R 8048	CHIP RES.	68k	1/10W	5%	RMC1/10T 683J	J24205683		1-	
R 8049	CHIP RES.	0	1/10W	5%	RMC1/10T 000J	J24205000		1-	
R 8050	CHIP RES.	220	1/10W	5%	RMC1/10T 221J	J24205221		1-	
R 8051	CHIP RES.	100	1/10W	5%	RMC1/10T 101J	J24205101		1-	
R 8052	CHIP RES.	100	1/10W	5%	RMC1/10T 101J	J24205101		1-	
R 8053	CHIP RES.	22k	1/10W	5%	RMC1/10T 223J	J24205223		1-	
R 8054	CHIP RES.	100	1/10W	5%	RMC1/10T 101J	J24205101		1-	
R 8055	CHIP RES.	4.7k	1/10W	5%	RMC1/10T 472J	J24205472		1-	
R 8056	CHIP RES.	100k	1/10W	5%	RMC1/10T 104J	J24205104		1-	

RX-2 Unit

Parts List

REF.	DESCRIPTION	VALUE	V/W	TOL.	MFR'S DESIG	YAESU P/N	VERS.	LOT.	LAYADR
R 8057	CHIP RES.	4.7k	1/10W	5%	RMC1/10T 472J	J24205472		1-	
R 8058	CHIP RES.	22k	1/10W	5%	RMC1/10T 223J	J24205223		1-	
R 8059	CHIP RES.	10k	1/10W	5%	RMC1/10T 103J	J24205103		1-	
R 8060	CHIP RES.	150	1/10W	5%	RMC1/10T 151J	J24205151		1-	
R 8061	CHIP RES.	3.3k	1/10W	5%	RMC1/10T 332J	J24205332		1-	
R 8062	CHIP RES.	15k	1/10W	5%	RMC1/10T 153J	J24205153		1-	
R 8063	CHIP RES.	15k	1/10W	5%	RMC1/10T 153J	J24205153		1-	
R 8064	CHIP RES.	1k	1/10W	5%	RMC1/10T 102J	J24205102		1-	
R 8065	CARBON FILM RES.	1.5M	1/6W	5%	RD16TPJ155 1.5M	J07225155		1-	
R 8066	CHIP RES.	10k	1/10W	5%	RMC1/10T 103J	J24205103		1-	
R 8067	CHIP RES.	1k	1/10W	5%	RMC1/10T 102J	J24205102		1-	
R 8068	CHIP RES.	10k	1/10W	5%	RMC1/10T 103J	J24205103		1-	
R 8069	CHIP RES.	100k	1/10W	5%	RMC1/10T 104J	J24205104		1-	
R 8070	CHIP RES.	10	1/10W	5%	RMC1/10T 100J	J24205100		1-	
R 8071	CHIP RES.	100	1/10W	5%	RMC1/10T 101J	J24205101		1-	
R 8072	CARBON FILM RES.	470k	1/6W	5%	RD16TPJ474 470K	J07225474		1-	
R 8073	CHIP RES.	470	1/10W	5%	RMC1/10T 471J	J24205471		1-	
R 8074	CHIP RES.	100k	1/10W	5%	RMC1/10T 104J	J24205104		1-	
R 8075	CHIP RES.	4.7k	1/10W	5%	RMC1/10T 472J	J24205472		1-	
R 8076	CHIP RES.	4.7k	1/10W	5%	RMC1/10T 472J	J24205472		1-	
R 8077	CHIP RES.	100	1/10W	5%	RMC1/10T 101J	J24205101		1-	
R 8078	CHIP RES.	100	1/10W	5%	RMC1/10T 101J	J24205101		1-	
R 8079	CHIP RES.	470	1/10W	5%	RMC1/10T 471J	J24205471		1-	
R 8080	CHIP RES.	100	1/10W	5%	RMC1/10T 101J	J24205101		1-	
R 8081	CHIP RES.	22k	1/10W	5%	RMC1/10T 223J	J24205223		1-	
R 8082	CHIP RES.	47k	1/10W	5%	RMC1/10T 473J	J24205473		1-	
R 8083	CHIP RES.	220k	1/10W	5%	RMC1/10T 224J	J24205224		1-	
R 8084	CHIP RES.	47k	1/10W	5%	RMC1/10T 473J	J24205473		1-	
R 8085	CHIP RES.	470	1/10W	5%	RMC1/10T 471J	J24205471		1-	
R 8086	CHIP RES.	470	1/10W	5%	RMC1/10T 471J	J24205471		1-	
R 8087	CHIP RES.	3.3k	1/10W	5%	RMC1/10T 332J	J24205332		1-	
R 8088	CHIP RES.	1k	1/10W	5%	RMC1/10T 102J	J24205102		1-	
R 8089	CHIP RES.	100	1/10W	5%	RMC1/10T 101J	J24205101		1-	
R 8090	CHIP RES.	100k	1/10W	5%	RMC1/10T 104J	J24205104		1-	
R 8091	CHIP RES.	27k	1/10W	5%	RMC1/10T 273J	J24205273		1-	
R 8092	CHIP RES.	100	1/10W	5%	RMC1/10T 101J	J24205101		1-	
R 8093	CHIP RES.	10k	1/10W	5%	RMC1/10T 103J	J24205103		1-	
R 8094	CHIP RES.	10k	1/10W	5%	RMC1/10T 103J	J24205103		1-	
R 8095	CARBON FILM RES.	12k	1/6W	5%	RD16TPJ123 12K	J07225123		1-	
R 8096	CHIP RES.	4.7k	1/10W	5%	RMC1/10T 472J	J24205472		1-	
R 8097	CHIP RES.	4.7k	1/10W	5%	RMC1/10T 472J	J24205472		1-	
R 8098	CHIP RES.	100	1/10W	5%	RMC1/10T 101J	J24205101		1-	
R 8099	CHIP RES.	4.7k	1/10W	5%	RMC1/10T 472J	J24205472		1-	
R 8100	CHIP RES.	100	1/10W	5%	RMC1/10T 101J	J24205101		1-	
R 8101	CHIP RES.	100	1/10W	5%	RMC1/10T 101J	J24205101		1-	
R 8102	CHIP RES.	10k	1/10W	5%	RMC1/10T 103J	J24205103		1-	
R 8103	CHIP RES.	10k	1/10W	5%	RMC1/10T 103J	J24205103		1-	
R 8104	CHIP RES.	100	1/10W	5%	RMC1/10T 101J	J24205101		1-	
R 8105	CHIP RES.	100	1/10W	5%	RMC1/10T 101J	J24205101		1-	
R 8106	CHIP RES.	150k	1/10W	5%	RMC1/10T 154J	J24205154		1-	
R 8107	CHIP RES.	4.7k	1/10W	5%	RMC1/10T 472J	J24205472		1-	
R 8108	CHIP RES.	4.7k	1/10W	5%	RMC1/10T 472J	J24205472		1-	
R 8109	CHIP RES.	100	1/10W	5%	RMC1/10T 101J	J24205101		1-	
R 8110	CHIP RES.	22k	1/10W	5%	RMC1/10T 223J	J24205223		1-	
R 8111	CHIP RES.	1k	1/10W	5%	RMC1/10T 102J	J24205102		1-	
R 8112	CHIP RES.	10k	1/10W	5%	RMC1/10T 103J	J24205103		1-	
R 8113	CHIP RES.	100	1/10W	5%	RMC1/10T 101J	J24205101		1-	
R 8114	CHIP RES.	100	1/10W	5%	RMC1/10T 101J	J24205101		1-	
R 8115	CHIP RES.	100	1/10W	5%	RMC1/10T 101J	J24205101		1-	
R 8116	CHIP RES.	220k	1/10W	5%	RMC1/10T 224J	J24205224		1-	
R 8117	CHIP RES.	100k	1/10W	5%	RMC1/10T 104J	J24205104		1-	
R 8118	CHIP RES.	680	1/10W	5%	RMC1/10T 681J	J24205681		1-	
R 8119	CHIP RES.	10	1/10W	5%	RMC1/10T 100J	J24205100		1-	
R 8120	CHIP RES.	47	1/10W	5%	RMC1/10T 470J	J24205470		1-	
R 8121	CHIP RES.	47k	1/10W	5%	RMC1/10T 473J	J24205473		1-	
R 8122	CHIP RES.	22k	1/10W	5%	RMC1/10T 223J	J24205223		1-	
R 8124	CHIP RES.	100k	1/10W	5%	RMC1/10T 104J	J24205104		1-	
R 8125	CHIP RES.	10k	1/10W	5%	RMC1/10T 103J	J24205103		1-	

RX-2 Unit

Parts List

REF.	DESCRIPTION	VALUE	V/W	TOL.	MFR'S DESIG	YAESU P/N	VERS.	LOT.	LAY ADR
R 8126	CHIP RES.	100	1/10W	5%	RMC1/10T 101J	J24205101		1-	
R 8127	CHIP RES.	22k	1/10W	5%	RMC1/10T 223J	J24205223		1-	
R 8128	CHIP RES.	22k	1/10W	5%	RMC1/10T 223J	J24205223		1-	
R 8129	CHIP RES.	470	1/10W	5%	RMC1/10T 471J	J24205471		1-	
R 8130	CHIP RES.	470	1/10W	5%	RMC1/10T 471J	J24205471		1-	
R 8131	CHIP RES.	150	1/10W	5%	RMC1/10T 151J	J24205151		1-	
R 8132	CHIP RES.	3.3k	1/10W	5%	RMC1/10T 332J	J24205332		1-	
R 8133	CHIP RES.	47k	1/10W	5%	RMC1/10T 473J	J24205473		1-	
R 8134	CHIP RES.	10k	1/10W	5%	RMC1/10T 103J	J24205103		1-	
R 8135	CARBON FILM RES.	56	1/6W	5%	RD16TPJ560 56	J07225560		1-	
R 8136	CHIP RES.	100	1/10W	5%	RMC1/10T 101J	J24205101		1-	
R 8137	CHIP RES.	100	1/10W	5%	RMC1/10T 101J	J24205101		1-	
R 8138	CHIP RES.	100	1/10W	5%	RMC1/10T 101J	J24205101		1-	
R 8139	CHIP RES.	100	1/10W	5%	RMC1/10T 101J	J24205101		1-	
R 8140	CHIP RES.	100	1/10W	5%	RMC1/10T 101J	J24205101		1-	
R 8141	CHIP RES.	100	1/10W	5%	RMC1/10T 101J	J24205101		1-	
R 8142	CHIP RES.	100k	1/10W	5%	RMC1/10T 104J	J24205104		1-	
R 8143	CHIP RES.	100k	1/10W	5%	RMC1/10T 104J	J24205104		1-	
R 8144	CHIP RES.	180	1/10W	5%	RMC1/10T 181J	J24205181		1-	
R 8145	CHIP RES.	47	1/10W	5%	RMC1/10T 470J	J24205470		1-	
R 8146	CHIP RES.	100k	1/10W	5%	RMC1/10T 104J	J24205104		1-	
R 8147	CHIP RES.	100	1/10W	5%	RMC1/10T 101J	J24205101		1-	
R 8148	CHIP RES.	10k	1/10W	5%	RMC1/10T 103J	J24205103		1-	
R 8149	CHIP RES.	100k	1/10W	5%	RMC1/10T 104J	J24205104		1-	
R 8150	CHIP RES.	100	1/10W	5%	RMC1/10T 101J	J24205101		1-	
R 8151	CHIP RES.	100	1/10W	5%	RMC1/10T 101J	J24205101		1-	
R 8152	CHIP RES.	470	1/10W	5%	RMC1/10T 471J	J24205471		1-	
R 8153	CHIP RES.	470	1/10W	5%	RMC1/10T 471J	J24205471		1-	
R 8154	CHIP RES.	470	1/10W	5%	RMC1/10T 471J	J24205471		1-	
R 8155	CHIP RES.	470	1/10W	5%	RMC1/10T 471J	J24205471		1-	
R 8156	CHIP RES.	220	1/10W	5%	RMC1/10T 221J	J24205221		1-	
R 8157	CHIP RES.	22k	1/10W	5%	RMC1/10T 223J	J24205223		1-	
R 8159	CHIP RES.	100k	1/10W	5%	RMC1/10T 104J	J24205104		1-	
R 8160	CHIP RES.	22k	1/10W	5%	RMC1/10T 223J	J24205223		1-	
R 8161	CHIP RES.	150	1/10W	5%	RMC1/10T 151J	J24205151		1-	
R 8162	CHIP RES.	33k	1/10W	5%	RMC1/10T 333J	J24205333		1-	
R 8165	CHIP RES.	10k	1/10W	5%	RMC1/10T 103J	J24205103		1-	
R 8166	CHIP RES.	33k	1/10W	5%	RMC1/10T 333J	J24205333		1-	
R 8167	CHIP RES.	150	1/10W	5%	RMC1/10T 151J	J24205151		1-	
R 8168	CHIP RES.	100	1/10W	5%	RMC1/10T 101J	J24205101		1-	
R 8169	CHIP RES.	100	1/10W	5%	RMC1/10T 101J	J24205101		1-	
R 8170	CHIP RES.	100	1/10W	5%	RMC1/10T 101J	J24205101		1-	
R 8171	CHIP RES.	2.2k	1/10W	5%	RMC1/10T 222J	J24205222		1-	
R 8172	CHIP RES.	100k	1/10W	5%	RMC1/10T 104J	J24205104		1-	
R 8173	CHIP RES.	1k	1/10W	5%	RMC1/10T 102J	J24205102		1-	
R 8174	CHIP RES.	22k	1/10W	5%	RMC1/10T 223J	J24205223		1-	
R 8176	CHIP RES.	100k	1/10W	5%	RMC1/10T 104J	J24205104		1-	
R 8177	CHIP RES.	22k	1/10W	5%	RMC1/10T 223J	J24205223		1-	
R 8178	CHIP RES.	270	1/10W	5%	RMC1/10T 271J	J24205271		1-	
R 8179	CHIP RES.	470	1/10W	5%	RMC1/10T 471J	J24205471		1-	
R 8180	CHIP RES.	150	1/10W	5%	RMC1/10T 151J	J24205151		1-	
R 8181	CHIP RES.	2.2k	1/10W	5%	RMC1/10T 222J	J24205222		1-	
R 8182	CHIP RES.	680	1/10W	5%	RMC1/10T 681J	J24205681		1-	
R 8183	CHIP RES.	100	1/10W	5%	RMC1/10T 101J	J24205101		1-	
R 8184	CHIP RES.	1k	1/10W	5%	RMC1/10T 102J	J24205102		1-	
R 8185	CHIP RES.	180	1/10W	5%	RMC1/10T 181J	J24205181		1-	
R 8186	CHIP RES.	1.5k	1/10W	5%	RMC1/10T 152J	J24205152		1-	
R 8187	CHIP RES.	3.3k	1/10W	5%	RMC1/10T 332J	J24205332		1-	
R 8188	CHIP RES.	1.8k	1/10W	5%	RMC1/10T 182J	J24205182		1-	
R 8189	CHIP RES.	470	1/10W	5%	RMC1/10T 471J	J24205471		1-	
R 8190	CHIP RES.	100k	1/10W	5%	RMC1/10T 104J	J24205104		1-	
R 8191	CHIP RES.	5.6k	1/10W	5%	RMC1/10T 562J	J24205562		1-	
R 8192	CHIP RES.	22k	1/10W	5%	RMC1/10T 223J	J24205223		1-	
R 8194	CHIP RES.	100k	1/10W	5%	RMC1/10T 104J	J24205104		1-	
R 8195	CHIP RES.	820	1/10W	5%	RMC1/10T 821J	J24205821		1-	
R 8196	CHIP RES.	22k	1/10W	5%	RMC1/10T 223J	J24205223		1-	
R 8197	CHIP RES.	0	1/10W	5%	RMC1/10T 000J	J24205000		1-	
R 8198	CHIP RES.	150	1/10W	5%	RMC1/10T 151J	J24205151		1-	

REF.	DESCRIPTION	VALUE	V/W	TOL.	MFR'S DESIG	YAESU P/N	VERS.	LOT.	LAY ADR
R 8199	CHIP RES.	100	1/10W	5%	RMC1/10T 101J	J24205101		1-	
R 8200	CARBON FILM RES.	390	1/6W	5%	RD16TPJ391 390	J07225391		1-	
R 8201	CHIP RES.	100k	1/10W	5%	RMC1/10T 104J	J24205104		1-	
R 8202	CHIP RES.	1k	1/10W	5%	RMC1/10T 102J	J24205102		1-	
R 8203	CHIP RES.	100k	1/10W	5%	RMC1/10T 104J	J24205104		1-	
R 8204	CHIP RES.	470	1/10W	5%	RMC1/10T 471J	J24205471		1-	
R 8205	CHIP RES.	470	1/10W	5%	RMC1/10T 471J	J24205471		1-	
R 8206	CHIP RES.	3.3k	1/10W	5%	RMC1/10T 332J	J24205332		1-	
R 8207	CHIP RES.	27k	1/10W	5%	RMC1/10T 273J	J24205273		1-	
R 8208	CHIP RES.	10k	1/10W	5%	RMC1/10T 103J	J24205103		1-	
R 8209	CHIP RES.	15k	1/10W	5%	RMC1/10T 153J	J24205153		1-	
R 8210	CHIP RES.	470	1/10W	5%	RMC1/10T 471J	J24205471		1-	
R 8211	CHIP RES.	2.7	1/10W	5%	RMC1/10T 2R7J	J24205279		1-	
R 8212	CHIP RES.	2.7	1/10W	5%	RMC1/10T 2R7J	J24205279		1-	
R 8213	CHIP RES.	470	1/10W	5%	RMC1/10T 471J	J24205471		1-	
R 8214	CHIP RES.	100	1/10W	5%	RMC1/10T 101J	J24205101		1-	
R 8215	CHIP RES.	1k	1/10W	5%	RMC1/10T 102J	J24205102		1-	
R 8216	CHIP RES.	330	1/10W	5%	RMC1/10T 331J	J24205331		1-	
R 8217	CHIP RES.	330	1/10W	5%	RMC1/10T 331J	J24205331		1-	
R 8218	CHIP RES.	5.6k	1/10W	5%	RMC1/10T 562J	J24205562		1-	
R 8221	CHIP RES.	680	1/10W	5%	RMC1/10T 681J	J24205681		1-	
R 8222	CHIP RES.	680	1/10W	5%	RMC1/10T 681J	J24205681		1-	
R 8223	CHIP RES.	3.3k	1/10W	5%	RMC1/10T 332J	J24205332		1-	
R 8224	CHIP RES.	1k	1/10W	5%	RMC1/10T 102J	J24205102		1-	
R 8230	CHIP RES.	1k	1/10W	5%	RMC1/10T 102J	J24205102		1-	
R 8231	CHIP RES.	2.2k	1/10W	5%	RMC1/10T 222J	J24205222		1-	
R 8232	CHIP RES.	47k	1/10W	5%	RMC1/10T 473J	J24205473		1-	
R 8233	CHIP RES.	47k	1/10W	5%	RMC1/10T 473J	J24205473		1-	
R 8234	CHIP RES.	270	1/10W	5%	RMC1/10T 271J	J24205271		1-	
R 8235	CHIP RES.	47k	1/10W	5%	RMC1/10T 473J	J24205473		1-	
R 8236	CHIP RES.	4.7k	1/10W	5%	RMC1/10T 472J	J24205472		1-	
R 8238	CHIP RES.	0	1/10W	5%	RMC1/10T 000J	J24205000		30-	
R 8239	CHIP RES.	150k	1/10W	5%	RMC1/10T 154J	J24205154		30-	
R 8240	CHIP RES.	1.5k	1/10W	5%	RMC1/10T 152J	J24205152		30-	
R 8241	CHIP RES.	0	1/10W	5%	RMC1/10T 000J	J24205000		30-	
R 8243	CHIP RES.	10k	1/10W	5%	RMC1/10T 103J	J24205103		30-	
R 8244	CHIP RES.	33k	1/10W	5%	RMC1/10T 333J	J24205333		30-	
R 8245	CHIP RES.	1k	1/10W	5%	RMC1/10T 102J	J24205102		30-	
T 8001	COIL 07RF	455kHz			455K	L0190002		1-	
T 8002	COIL 07RF	47.1MHz			47.1M R12-M412A	L0021223		1-	
T 8003	COIL 07RF	47MHz			47.0M	L0021482A		1-	
T 8004	COIL 07RF	455kHz			455KHZ	L0021476		1-	
T 8005	COIL 07RF	455kHz			455K	L0190002		1-	
T 8006	COIL 07RF	455kHz			455K	L0190002		1-	
T 8007	COIL RF				R12°7947C	L0020422		1-	
T 8008	COIL 07WIDE				2001F	L0021973		1-	
T 8009	COIL 07RF	47.1MHz			47.1M R12-M411A	L0021225		1-	
T 8010	COIL 07RF	47.1MHz			47.1M R12-M411A	L0021225		1-	
T 8011	COIL 07RF	47MHz			47.0M	L0021482A		1-	
T 8012	COIL 07RF	40.96MHz			40.96M R12-M424A	L0021941		1-	
T 8013	COIL 07RF	42MHz			42.0M	L0021511		1-	
T 8014	COIL 07RF	42MHz			42.0M	L0021511		1-	
T 8015	COIL 07RF	455kHz			455K	L0190002		1-	
T 8016	COIL 07RF	46.08MHz			46.08M R12-M421A	L0021939		1-	
T 8017	COIL 07RF	46.08MHz			46.08M R12-M421A	L0021939		1-	
T 8018	COIL 07RF	46.08MHz			46.08M R12-M421A	L0021939		1-	
T 8019	COIL 07RF	455kHz			455K	L0190002		1-	
T 8020	COIL RF				R12°7943B	L0020420		1-	
TH8001	THERMISTOR				157-252-53006TP	G9090053		1-	
TH8002	THERMISTOR				157-501-53009TP	G9090058		1-	
TH8003	THERMISTOR				157-502-53002TP	G9090049		1-	
TH8004	THERMISTOR				157-501-53009TP	G9090058		1-	
TP8001	TERMINAL				TP-K IPS-1136	Q5000050		1-	
TP8002	TERMINAL				TP-K IPS-1136	Q5000050		1-	
TP8003	TERMINAL				TP-K IPS-1136	Q5000050		1-	
TP8004	TERMINAL				TP-K IPS-1136	Q5000050		1-	
TP8005	TERMINAL				TP-K IPS-1136	Q5000050		1-	
TP8006	TERMINAL				TP-K IPS-1136	Q5000050		1-	

RX-2 Unit

Parts List

REF.	DESCRIPTION	VALUE	V/W	TOL.	MFR'S DESIG	YAESU P/N	VERS.	LOT.	LAYADR
VR8001	POT.	2.2k			RH063MCJ3R 2.2KB	J51794222		1-	
VR8002	POT.	10k			RH063MC14R 10KB	J51794103		1-	
VR8004	POT.	470			RH063MCS2R 470B	J51794471		1-	
VR8005	POT.	470			RH063MCS2R 470B	J51794471		1-	
VR8006	POT.	4.7k			RH063MCS3R 4.7KB	J51794472		1-	
VR8007	POT.	10k			RH063MC14R 10KB	J51794103		1-	
X 8001	XTAL HC-49/T	46.755MHz			46.755MHZ 3P	H0103058A		1-	
XF8001	XTAL FILTER				47G10AU	H1102257		1-	
	SHIELD CASE				VCO	R0124120		1-	
	CASE COVER				VCO	R0124131		1-	
	SHIELD CASE					R0131670A		1-	
	SHIELD CASE					R0131670A		30-	
	CARD SPACER				WLS-04-0	S6000191		1-	
	SHIELD CASE COVER					R0131640		1-	
	SHIELD PLATE					R0146381		4-	
	SHIELD PLATE					R0153140		5-	

RX2PLL-DDS Unit

Parts Layout



RX2PLL-DDS Unit

Parts List

REF.	DESCRIPTION	VALUE	V/W	TOL.	MFR'S DESIG	YAESU P/N	VERS.	LOT.	LAY ADR
P.C.B. with Components						CB1206001			
Printed Circuit Board						F3255102B			
C 8501	CHIP CAP.	0.01uF	50V	B	GRM40B103M50PT	K22170817		1-	
C 8502	CHIP CAP.	0.01uF	50V	B	GRM40B103M50PT	K22170817		1-	
C 8503	CHIP CAP.	56pF	50V	CH	GRM40CH560J50PT	K22170229		1-	
C 8504	CHIP CAP.	150pF	50V	CH	GRM40CH151J50PT	K22170239		1-	
C 8505	CHIP TA.CAP.	4.7uF	6.3V		TEMSVA0J475M-8R	K78080017		1-	
C 8506	CHIP CAP.	100pF	50V	CH	GRM40CH101J50PT	K22170235		1-	
C 8507	CHIP CAP.	0.1uF	25V	B	GRM40B104M25PT	K22140811		1-	
C 8508	CHIP CAP.	0.0012uF	50V	B	GRM40B122M50PT	K22170806		1-	
C 8509	CHIP CAP.	0.0018uF	50V	B	GRM40B182M50PT	K22170808		1-	
C 8510	CHIP CAP.	0.0012uF	50V	B	GRM40B122M50PT	K22170806		1-	
C 8511	CHIP CAP.	0.1uF	25V	B	GRM40B104M25PT	K22140811		1-	
C 8512	CHIP TA.CAP.	4.7uF	6.3V		TEMSVA0J475M-8R	K78080017		1-	
C 8513	CHIP CAP.	0.1uF	25V	B	GRM40B104M25PT	K22140811		1-	
C 8514	CHIP CAP.	0.01uF	50V	B	GRM40B103M50PT	K22170817		1-	
C 8515	CHIP CAP.	7pF	50V	CH	GRM40CH070D50PT	K22170208		1-	
C 8516	CHIP CAP.	0.1uF	25V	B	GRM40B104M25PT	K22140811		1-	
C 8517	CHIP CAP.	0.1uF	25V	B	GRM40B104M25PT	K22140811		1-	
C 8518	CHIP CAP.	0.1uF	25V	B	GRM40B104M25PT	K22140811		1-	
J 8501	CONNECTOR				3022-04B	P0090523		1-	
J 8502	CONNECTOR				3022-05B	P0090594		1-	
L 8501	M.RFC	220uH			FLC32T-221J	L1690231		1-	
L 8502	M.RFC	220uH			FLC32T-221J	L1690231		1-	
L 8503	M.RFC	220uH			FLC32T-221J	L1690231		1-	
L 8504	M.RFC	220uH			FLC32T-221J	L1690231		1-	
Q 8501	TRANSISTOR				2SC2812L6-TA	G3328127F		1-	B
Q 8501	TRANSISTOR				2SC2812NL6-TB	G3328128F		8-	B
Q 8502	IC				FQ7928	G1092005		1-	A
Q 8503	TRANSISTOR				2SC2812L6-TA	G3328127F		1-	B
Q 8503	TRANSISTOR				2SC2812NL6-TB	G3328128F		8-	B
R 8501	CHIP RES.	22k	1/10W	5%	RMC1/10T 223J	J24205223		1-	
R 8502	CHIP RES.	470	1/10W	5%	RMC1/10T 471J	J24205471		1-	
R 8503	CHIP RES.	10k	1/10W	5%	RMC1/10T 103J	J24205103		1-	
R 8504	CHIP RES.	22k	1/10W	5%	RMC1/10T 223J	J24205223		1-	
R 8505	CHIP RES.	100	1/10W	5%	RMC1/10T 101J	J24205101		1-	
R 8506	CHIP RES.	1k	1/10W	5%	RMC1/10T 102J	J24205102		1-	
R 8507	CHIP RES.	100k	1/10W	5%	RMC1/10T 104J	J24205104		1-	
RB8501	BLOCK RES.				RRP20B-12Z-10K/20K	J40900180		1-	
	SHIELD CASE					R0131630		1-	

RX2CAR-DDS Unit

Parts Layout

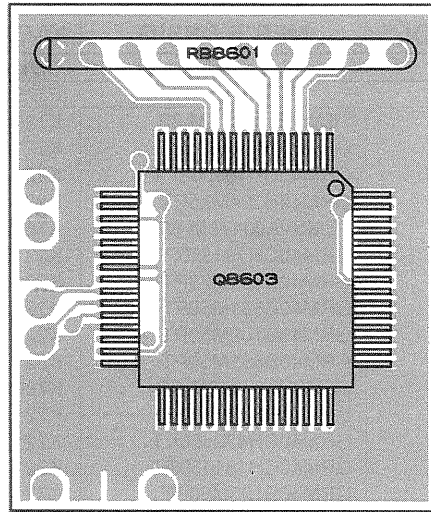

Side A

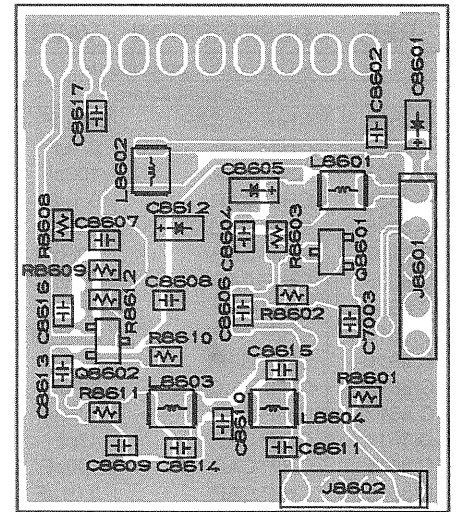

Side B

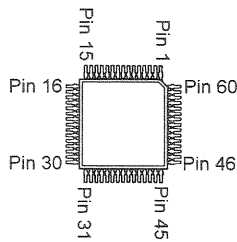

TC23SC030AF
(Q8603)

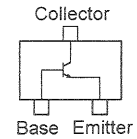

2SC2812 (L6)
(Q8601, 8602)

Circuit Diagram

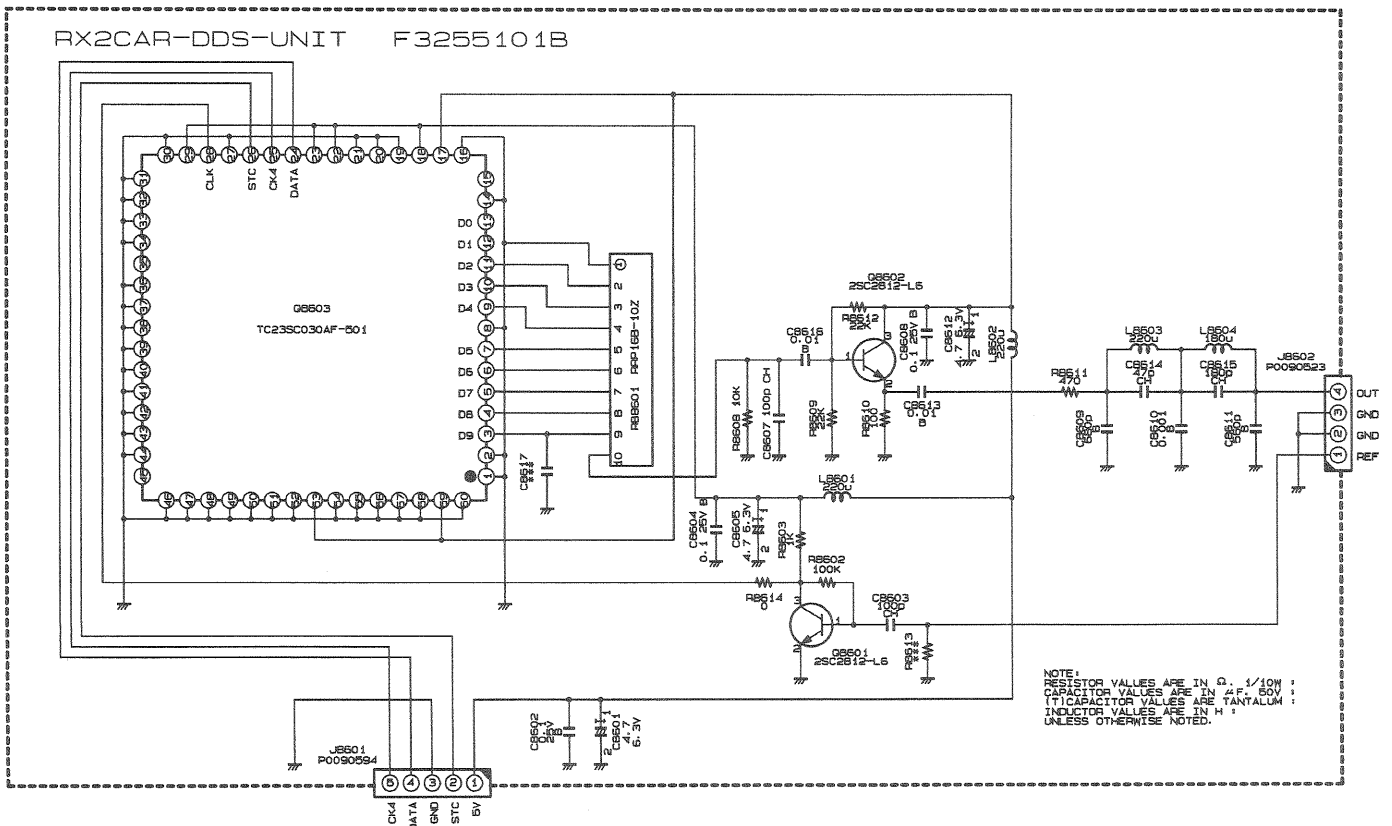

RX2CAR-DDS Unit

Parts List

REF.	DESCRIPTION	VALUE	V/W	TOL.	MFR'S DESIG	YAESU P/N	VERS.	LOT.	LAY ADR
P.C.B. with Components						CB1207001			
Printed Circuit Board						F3255101B		1	
C 8601	CHIP TA.CAP.	4.7uF	6.3V		TEMSVA0J475M-8R	K78080017		1-	
C 8602	CHIP CAP.	0.1uF	25V	B	GRM40B104M25PT	K22140811		1-	
C 8603	CHIP CAP.	100pF	50V	CH	GRM40CH101J50PT	K22170235		1-	
C 8604	CHIP CAP.	0.1uF	25V	B	GRM40B104M25PT	K22140811		1-	
C 8605	CHIP TA.CAP.	4.7uF	6.3V		TEMSVA0J475M-8R	K78080017		1-	
C 8607	CHIP CAP.	100pF	50V	CH	GRM40CH101J50PT	K22170235		1-	
C 8608	CHIP CAP.	0.1uF	25V	B	GRM40B104M25PT	K22140811		1-	
C 8609	CHIP CAP.	680pF	50V	B	GRM40B681M50PT	K22170803		1-	
C 8610	CHIP CAP.	0.001uF	50V	B	GRM40B102M50PT	K22170805		1-	
C 8611	CHIP CAP.	560pF	50V	B	GRM40B561M50PT	K22170802		1-	
C 8612	CHIP TA.CAP.	4.7uF	6.3V		TEMSVA0J475M-8R	K78080017		1-	
C 8613	CHIP CAP.	0.01uF	50V	B	GRM40B103M50PT	K22170817		1-	
C 8614	CHIP CAP.	47pF	50V	CH	GRM40CH470J50PT	K22170227		1-	
C 8615	CHIP CAP.	180pF	50V	CH	GRM40CH181J50PT	K22170241		1-	
C 8616	CHIP CAP.	0.01uF	50V	B	GRM40B103M50PT	K22170817		1-	
J 8601	CONNECTOR				3022-05B	P0090594		1-	
J 8602	CONNECTOR				3022-04B	P0090523		1-	
L 8601	M.RFC	220uH			FLC32T-221J	L1690231		1-	
L 8602	M.RFC	220uH			FLC32T-221J	L1690231		1-	
L 8603	M.RFC	220uH			FLC32T-221J	L1690231		1-	
L 8604	M.RFC	180uH			FLC32T-181J	L1690230		1-	
Q 8601	TRANSISTOR				2SC2812L6-TA	G3328127F		1-	B
Q 8601	TRANSISTOR				2SC2812NL6-TB	G3328128F		8-	B
Q 8602	TRANSISTOR				2SC2812L6-TA	G3328127F		1-	B
Q 8602	TRANSISTOR				2SC2812NL6-TB	G3328128F		8-	B
Q 8603	IC				TC23SC030AF-501	G1090970		1-	A
R 8602	CHIP RES.	100k	1/10W	5%	RMC1/10T 104J	J24205104		1-	
R 8603	CHIP RES.	1k	1/10W	5%	RMC1/10T 102J	J24205102		1-	
R 8608	CHIP RES.	10k	1/10W	5%	RMC1/10T 103J	J24205103		1-	
R 8609	CHIP RES.	22k	1/10W	5%	RMC1/10T 223J	J24205223		1-	
R 8610	CHIP RES.	100	1/10W	5%	RMC1/10T 101J	J24205101		1-	
R 8611	CHIP RES.	470	1/10W	5%	RMC1/10T 471J	J24205471		1-	
R 8612	CHIP RES.	22k	1/10W	5%	RMC1/10T 223J	J24205223		1-	
R 8614	CHIP RES.	0	1/10W	5%	RMC1/10T 000J	J24205000		1-	
RB8601	BLOCK RES.				RRP16B-10Z-10K/20K	J40900181		1-	
	SHIELD CASE					R0131630		1-	

REG Unit Circuit Diagram

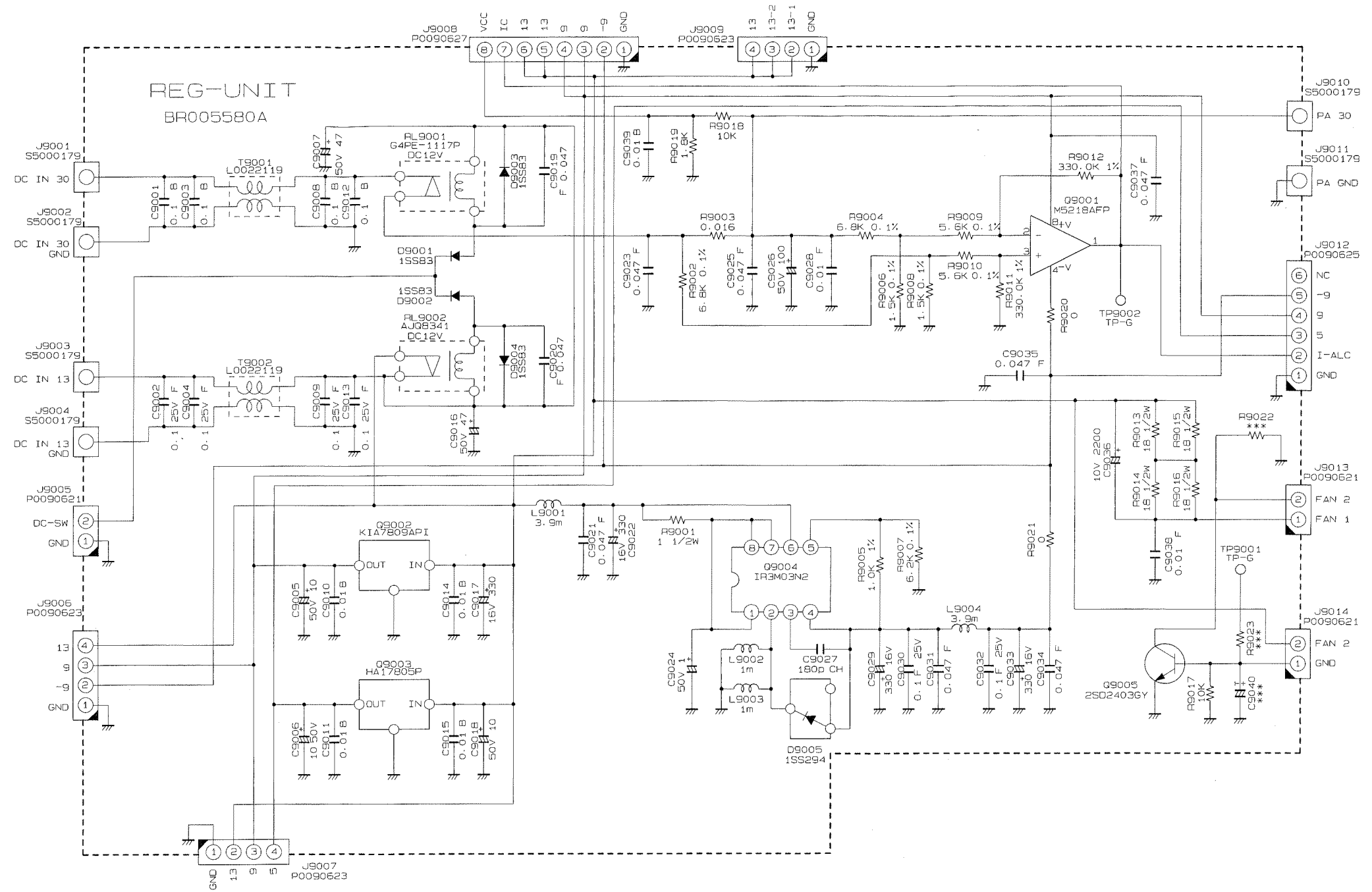

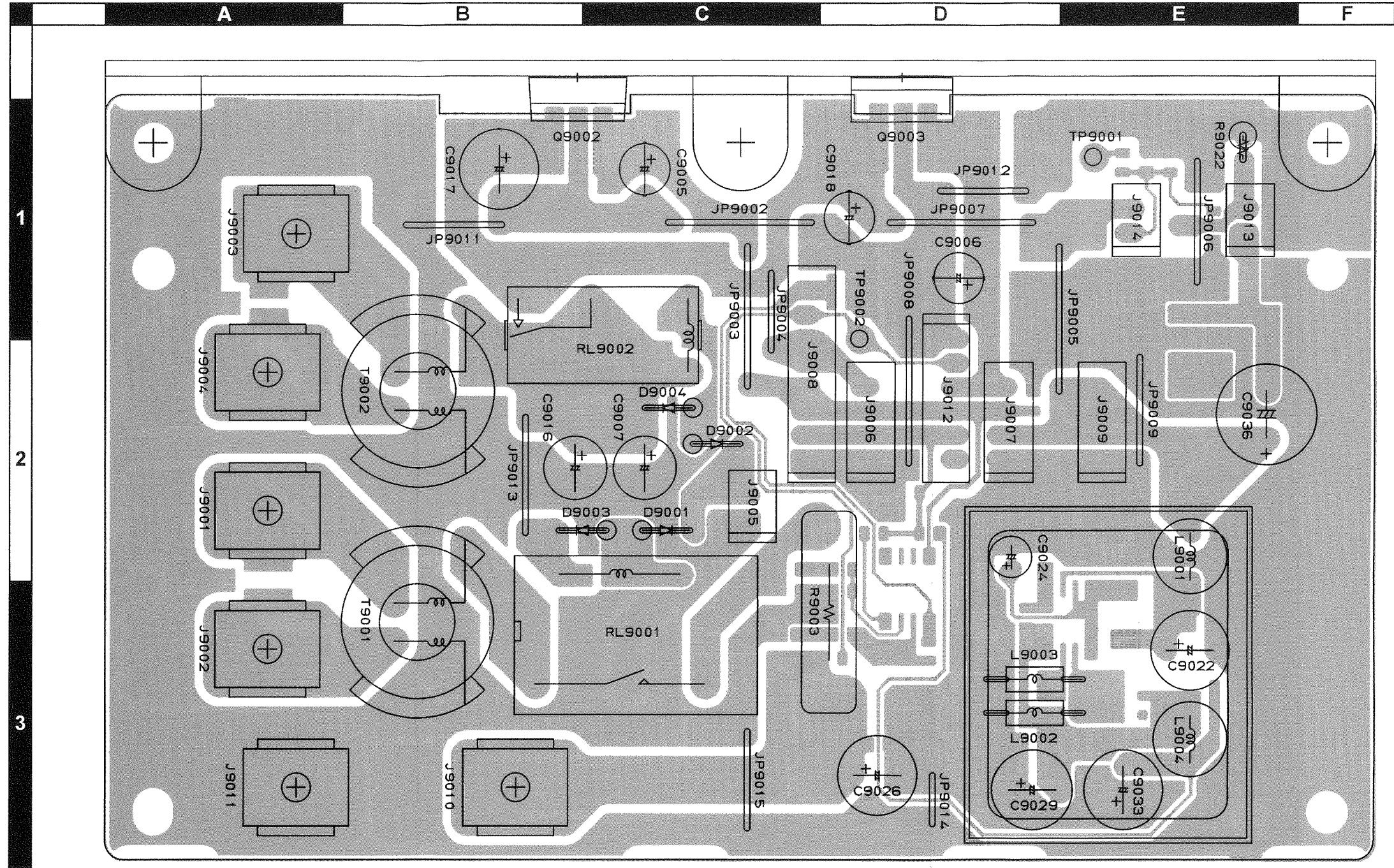

Side A

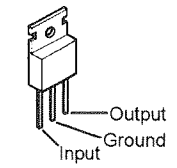

HA17805
(Q9003)

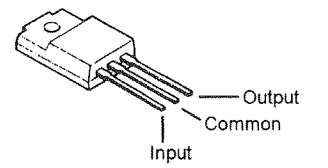

KIA7809
(Q9002)

REG Unit

Parts Layout

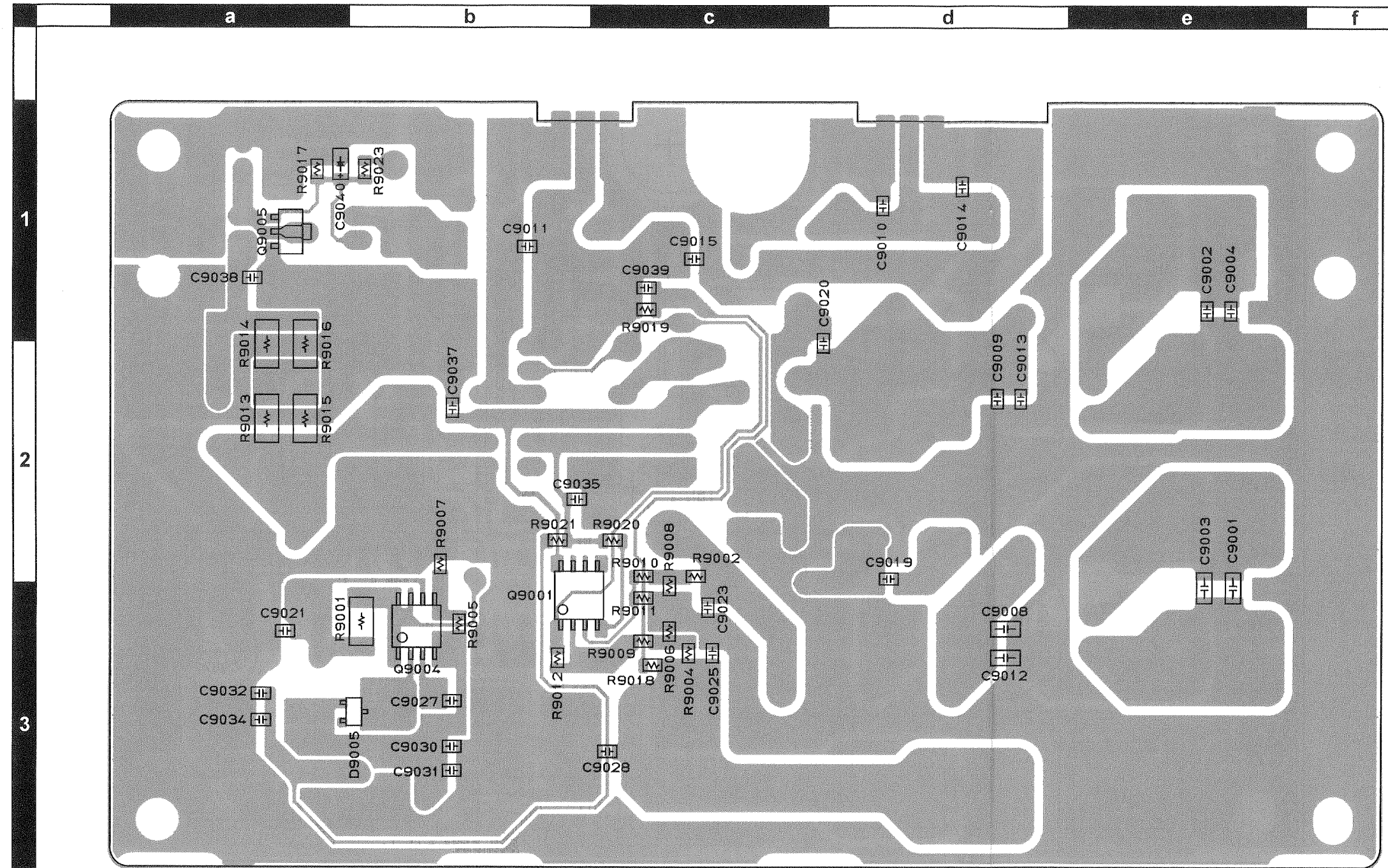

Side B

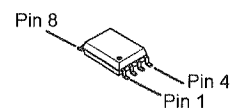

M5218AFP
(Q9001)
IR3M03N2
(Q9004)

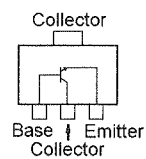

2SD2403GY (GY)
(Q9005)

REG Unit

Parts List

REF.	DESCRIPTION	VALUE	V/W	TOL.	MFR'S DESIG	YAESU P/N	VERS.	LOT.	LAY ADR
P.C.B. with Components						CB1186001			
Printed Circuit Board						FR005580B		1-	
C 9001	CHIPCAP.	0.1uF	50V	B	GRM42-6B104K50PT	K22171820		1-	
C 9002	CHIPCAP.	0.1uF	25V	F	GRM40F104Z25PT	K22141005		1-	
C 9003	CHIPCAP.	0.1uF	50V	B	GRM42-6B104K50PT	K22171820		1-	
C 9004	CHIPCAP.	0.1uF	25V	F	GRM40F104Z25PT	K22141005		1-	
C 9005	AL.ELECTRO.CAP.	10uF	50V		50V100M5X11TR5	K46170021		1-	
C 9006	AL.ELECTRO.CAP.	10uF	50V		50V100M5X11TR5	K46170021		1-	
C 9007	AL.ELECTRO.CAP.	47uF	50V		50V470M6X11TR5	K46170024		1-	
C 9008	CHIPCAP.	0.1uF	50V	B	GRM42-6B104K50PT	K22171820		1-	
C 9009	CHIPCAP.	0.1uF	25V	F	GRM40F104Z25PT	K22141005		1-	
C 9010	CHIPCAP.	0.01uF	50V	B	GRM40B103M50PT	K22170817		1-	
C 9011	CHIPCAP.	0.01uF	50V	B	GRM40B103M50PT	K22170817		1-	
C 9012	CHIPCAP.	0.1uF	50V	B	GRM42-6B104K50PT	K22171820		1-	
C 9013	CHIPCAP.	0.1uF	25V	F	GRM40F104Z25PT	K22141005		1-	
C 9014	CHIPCAP.	0.01uF	50V	B	GRM40B103M50PT	K22170817		1-	
C 9015	CHIPCAP.	0.01uF	50V	B	GRM40B103M50PT	K22170817		1-	
C 9016	AL.ELECTRO.CAP.	47uF	50V		50V470M6X11TR5	K46170024		1-	
C 9017	AL.ELECTRO.CAP.	330uF	16V		16V331M8X11TR5	K46120002		1-	
C 9018	AL.ELECTRO.CAP.	10uF	50V		50V100M5X11TR5	K46170021		1-	
C 9019	CHIPCAP.	0.047uF	50V	F	GRM40F473Z50PT	K22171008		1-	
C 9020	CHIPCAP.	0.047uF	50V	F	GRM40F473Z50PT	K22171008		1-	
C 9021	CHIPCAP.	0.047uF	50V	F	GRM40F473Z50PT	K22171008		1-	
C 9022	AL.ELECTRO.CAP.	330uF	16V		16V331M8X11TR5	K46120002		1-	
C 9023	CHIPCAP.	0.047uF	50V	F	GRM40F473Z50PT	K22171008		1-	
C 9024	AL.ELECTRO.CAP.	1uF	50V		50V010M4X7TR2	K46170030		1-	
C 9025	CHIPCAP.	0.047uF	50V	F	GRM40F473Z50PT	K22171008		1-	
C 9026	AL.ELECTRO.CAP.	100uF	50V		50V101M8X11TR5	K46170025		1-	
C 9027	CHIPCAP.	180pF	50V	CH	GRM40CH181J50PT	K22170241		1-	
C 9028	CHIPCAP.	0.01uF	50V	F	GRM40F103Z50PT	K22171004		1-	
C 9029	AL.ELECTRO.CAP.	330uF	16V		16V331M8X11TR5	K46120002		1-	
C 9030	CHIPCAP.	0.1uF	25V	F	GRM40F104Z25PT	K22141005		1-	
C 9031	CHIPCAP.	0.047uF	50V	F	GRM40F473Z50PT	K22171008		1-	
C 9032	CHIPCAP.	0.1uF	25V	F	GRM40F104Z25PT	K22141005		1-	
C 9033	AL.ELECTRO.CAP.	330uF	16V		16V331M8X11TR5	K46120002		1-	
C 9034	CHIPCAP.	0.047uF	50V	F	GRM40F473Z50PT	K22171008		1-	
C 9035	CHIPCAP.	0.047uF	50V	F	GRM40F473Z50PT	K22171008		1-	
C 9036	AL.ELECTRO.CAP.	2200uF	10V		RE3-10V222M 2200UF	K40109032		1-	
C 9037	CHIPCAP.	0.047uF	50V	F	GRM40F473Z50PT	K22171008		1-	
C 9038	CHIPCAP.	0.01uF	50V	F	GRM40F103Z50PT	K22171004		1-	
C 9039	CHIPCAP.	0.01uF	50V	B	GRM40B103M50PT	K22170817		1-	
D 9001	DIODE				1SS83RE	G2050007		1-	C2
D 9002	DIODE				1SS83RE	G2050007		1-	C2
D 9003	DIODE				1SS83RE	G2050007		1-	C2
D 9004	DIODE				1SS83RE	G2050007		1-	C2
D 9005	DIODE				1SS294 TE85R	G2070058		1-	b3
J 9001	TERMINAL				Y106	S5000179		1-	
J 9002	TERMINAL				Y106	S5000179		1-	
J 9003	TERMINAL				Y106	S5000179		1-	
J 9004	TERMINAL				Y106	S5000179		1-	
J 9005	CONNECTOR				SC25-02WS	P0090621		1-	
J 9006	CONNECTOR				SC25-04WS	P0090623		1-	
J 9007	CONNECTOR				SC25-04WS	P0090623		1-	
J 9008	CONNECTOR				SC25-08WS	P0090627		1-	
J 9009	CONNECTOR				SC25-04WS	P0090623		1-	
J 9010	TERMINAL				Y106	S5000179		1-	
J 9011	TERMINAL				Y106	S5000179		1-	
J 9012	CONNECTOR				SC25-06WS	P0090625		1-	
J 9013	CONNECTOR				SC25-02WS	P0090621		1-	
J 9014	CONNECTOR				SC25-02WS	P0090621		1-	
L 9001	M.RFC	3.9mH			RCR-875D-392K	L1190383		1-	
L 9002	M.RFC	1mH			LAL03TA102K	L1790119		1-	
L 9003	M.RFC	1mH			LAL03TA102K	L1790119		1-	
L 9004	M.RFC	3.9mH			RCR-875D-392K	L1190383		1-	
Q 9001	IC				M5218AFP-600C	G1091607		1-	b3
Q 9001	IC				NJM4558M(Te1)	G1093334		5-	b3
Q 9002	IC				KIA7809API	G1093165		1-	B1
Q 9003	IC				HA17805P	G1090936		1-	D1

REG Unit

Parts List

REF.	DESCRIPTION	VALUE	V/W	TOL.	MFR'S DESIG	YAESU P/N	VERS.	LOT.	LAYADR
Q 9004	C				IR3M03N2	G1091300		1-	b3
Q 9005	TRANSISTOR				2SD2403GY-T1	G3424038Y		1-	a1
R 9001	CHIPRES.	1	1/2W	5%	RMC1/2 1R0JCTP	J24275010		1-	
R 9002	CHIPRES.	6.8k	1/10W	0.10%	RR1220P-682-B	J24209094		1-	
R 9003	SHUNTRES.	0.016		5%	R016	J32009018		1-	
R 9004	CHIPRES.	6.8k	1/10W	0.10%	RR1220P-682-B	J24209094		1-	
R 9005	CHIPRES.	1k	1/10W	1%	RMC1/10 1001FTP	J24209016		1-	
R 9006	CHIPRES.	1.5k	1/10W	0.10%	RR1220P-152-B	J24209078		1-	
R 9007	CHIPRES.	6.2k	1/10W	0.10%	RR1220P-622-B	J24209093		1-	
R 9008	CHIPRES.	1.5k	1/10W	0.10%	RR1220P-152-B	J24209078		1-	
R 9009	CHIPRES.	5.6k	1/10W	0.10%	RR1220P-562-B	J24209092		1-	
R 9010	CHIPRES.	5.6k	1/10W	0.10%	RR1220P-562-B	J24209092		1-	
R 9011	CHIPRES.	330k	1/10W	1%	RMC1/10 3303FTP	J24209043		1-	
R 9012	CHIPRES.	330k	1/10W	1%	RMC1/10 3303FTP	J24209043		1-	
R 9013	CHIPRES.	18	1/2W	5%	RMC1/2 180JTE	J24275180		1-	
R 9014	CHIPRES.	18	1/2W	5%	RMC1/2 180JTE	J24275180		1-	
R 9015	CHIPRES.	18	1/2W	5%	RMC1/2 180JTE	J24275180		1-	
R 9015	CHIPRES.	0	1/2W	5%	RMC1/2JPATE	J24275000		9-	
R 9016	CHIPRES.	18	1/2W	5%	RMC1/2 180JTE	J24275180		1-	
R 9017	CHIPRES.	10k	1/10W	5%	RMC1/10T 103J	J24205103		1-	
R 9018	CHIPRES.	10k	1/10W	5%	RMC1/10T 103J	J24205103		1-	
R 9019	CHIPRES.	1.8k	1/10W	5%	RMC1/10T 182J	J24205182		1-	
R 9020	CHIPRES.	0	1/10W	5%	RMC1/10T 000J	J24205000		1-	
R 9021	CHIPRES.	0	1/10W	5%	RMC1/10T 000J	J24205000		1-	
RL9001	RELAY		DC12V		G4PE-1117P DC12V	M1190095		1-	
RL9002	RELAY		DC12V		AJQ8341 DC12V	M1190115		1-	
T 9001	TOROIDAL COIL				D12A R116X8X8	L0022119		1-	
T 9002	TOROIDAL COIL				D12A R116X8X8	L0022119		1-	
TP9001	TERMINAL				TP-G MK1095	Q5000036		1-	
TP9002	TERMINAL				TP-G MK1095	Q5000036		1-	
	LEAF SPRING SHIELD CASE SHIELD CASE COVER LEAF SPRING HEATSINK PLATE SHIELD PLATE				(REG)	R0120250 R0131630 R0131640 R0140031 R0151150 RA0256900		1- 1- 1- 1- 1- 1-	

SW-A Unit Circuit Diagram

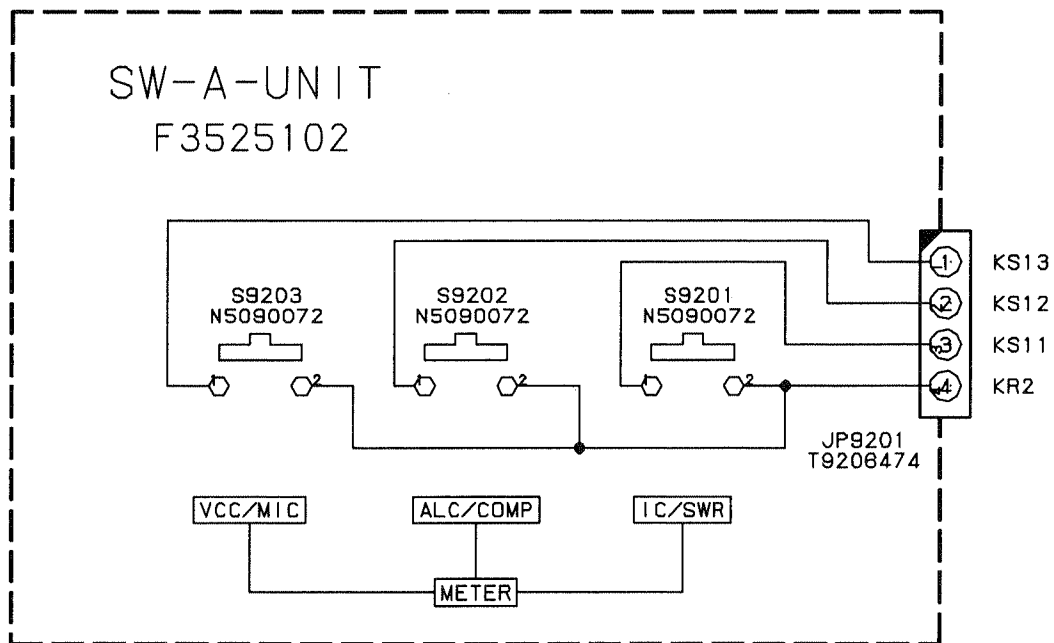

SW-A Unit Parts Layout

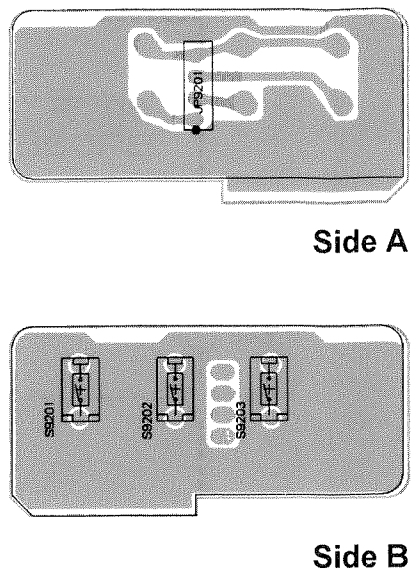

SW-C Unit Circuit Diagram

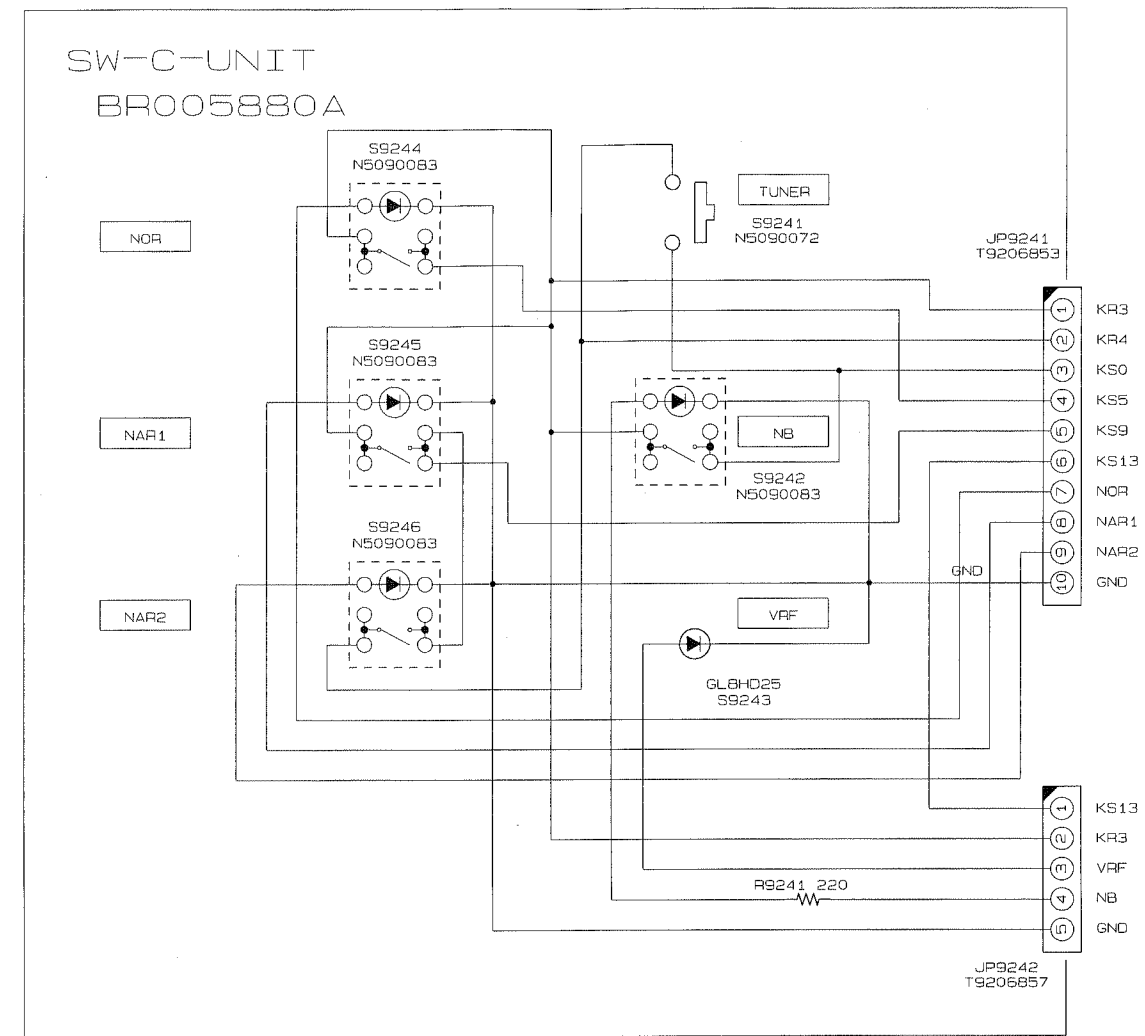

SW-B Unit Circuit Diagram

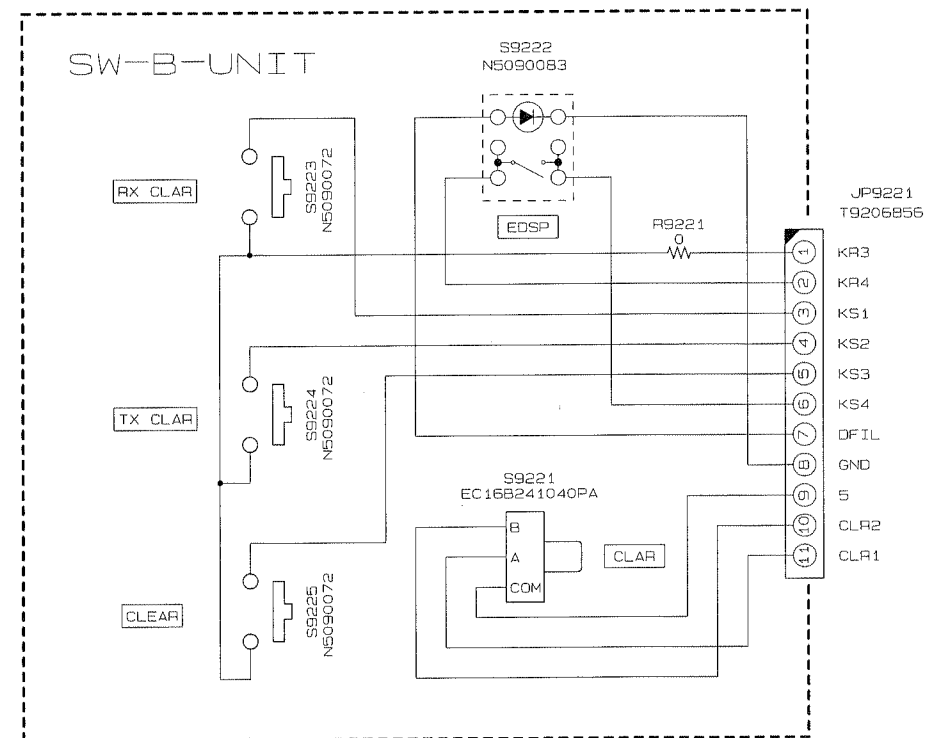

SW-B Unit Parts Layout

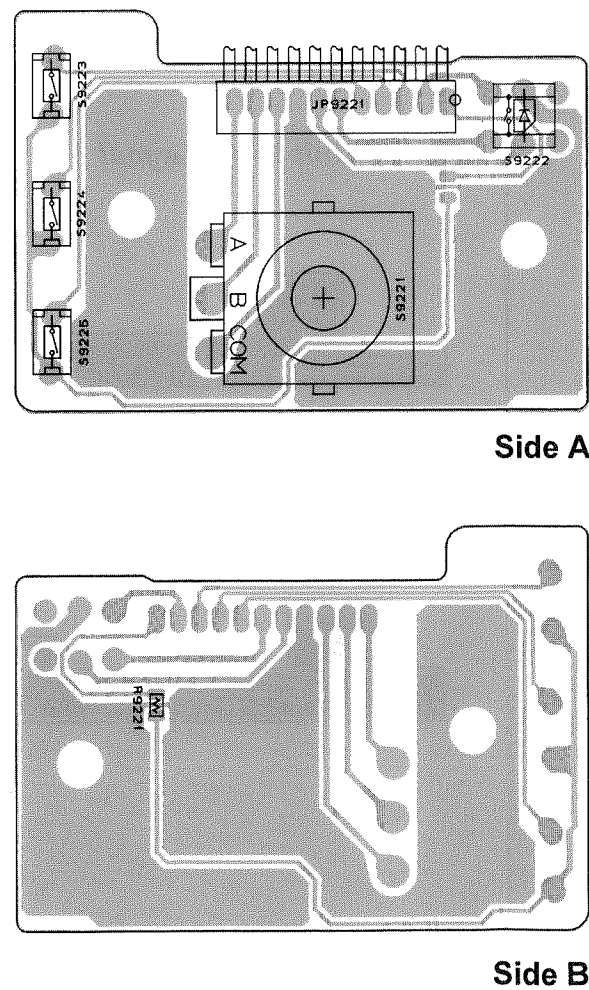

SW-C Unit Parts Layout

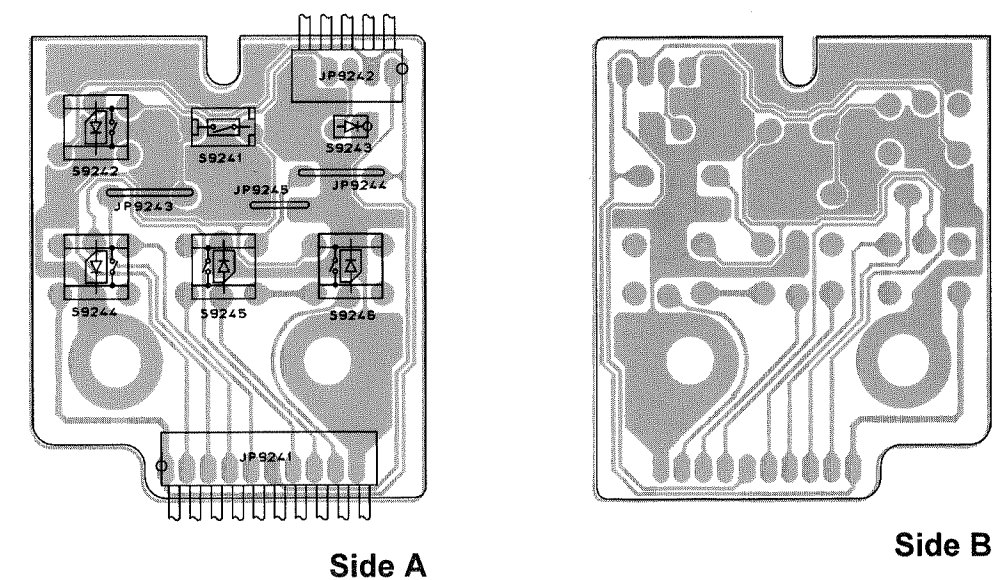

SW-A, B, C, D, E Unit

SW-D Unit Circuit Diagram

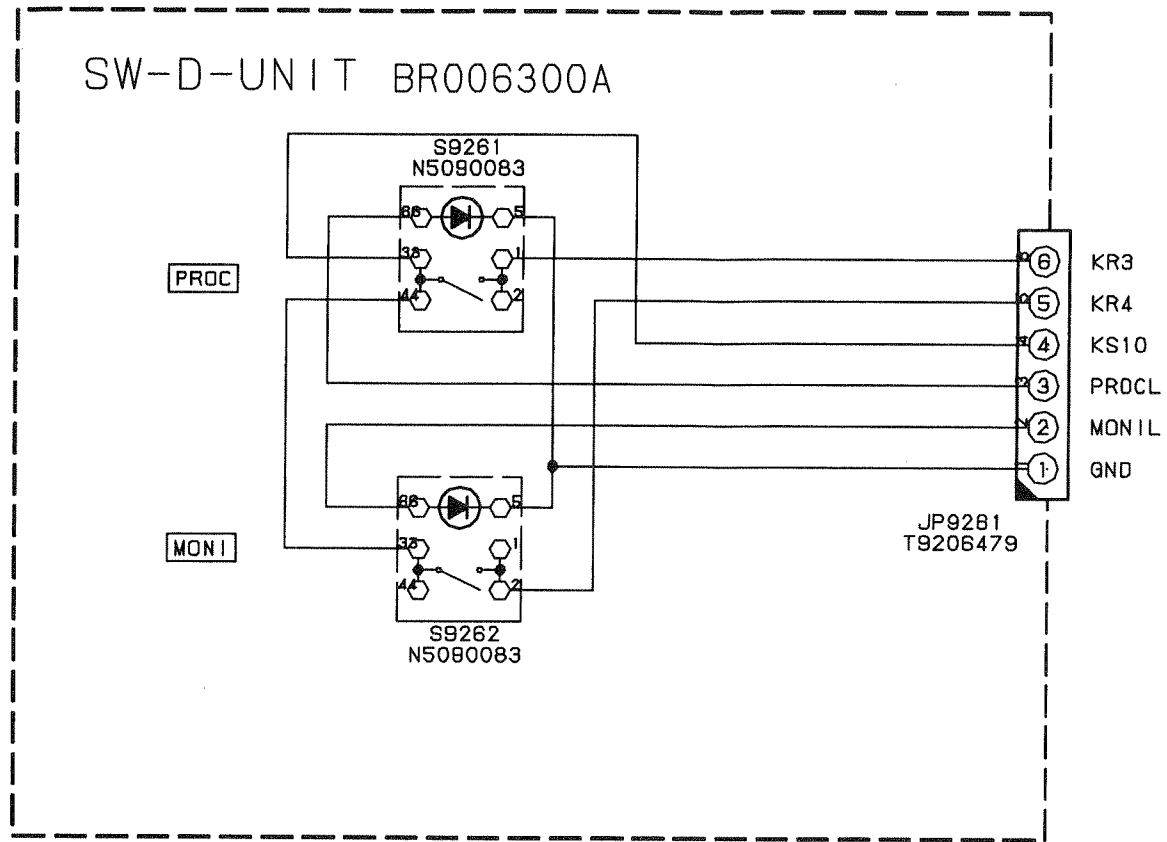

SW-D Unit Parts Layout

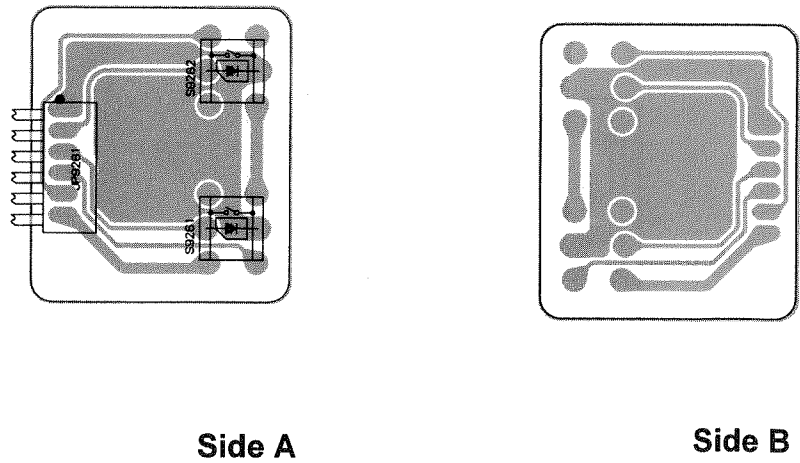

SW-E Unit Circuit Diagram

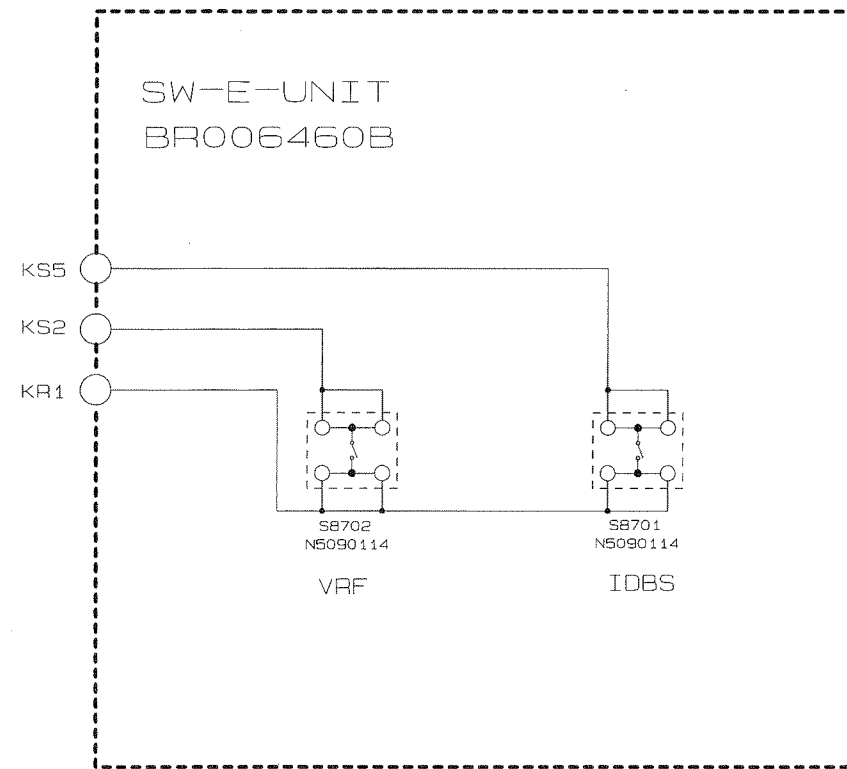

SW-E Unit Parts Layout

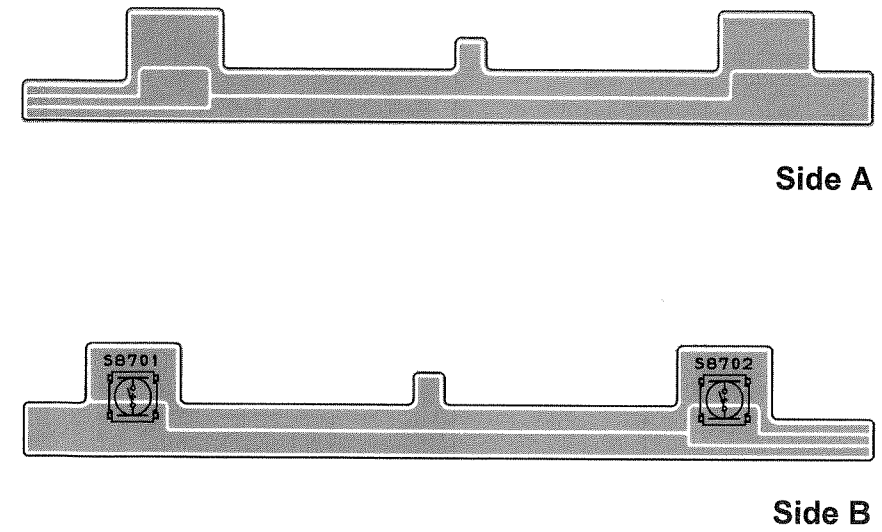

SW-A, B, C, D, E Unit

Parts List

REF.	DESCRIPTION	VALUE	V/W	TOL.	MFR'S DESIG	YAESU P/N	VERS.	LOT.	LAY ADR
*** SW-A UNIT ***									
PCB with Components						CB1312001			
Printed Circuit Board						F3525102		1-	
JP9201	WIRE ASSY					T9206474		1-	
S 9201	TACT SWITCH				SKQCAE	N5090072		1-	
S 9202	TACT SWITCH				SKQCAE	N5090072		1-	
S 9203	TACT SWITCH				SKQCAE	N5090072		1-	
*** SW-B UNIT ***									
PCB with Components						CB1307001			
Printed Circuit Board						FR005870A		1-	
JP9221	WIRE ASSY					T9206856		1-	
R 9221	CHIP RES.	0	1/10W	5%	RMC1/10T 000J	J24205000		1-	
S 9221	ROTARY ENCODER				EC16B241040PA	Q9000641		1-	
S 9222	TACT SWITCH				SKHQFM	N5090083		1-	
S 9223	TACT SWITCH				SKQCAE	N5090072		1-	
S 9224	TACT SWITCH				SKQCAE	N5090072		1-	
S 9225	TACT SWITCH				SKQCAE	N5090072		1-	
*** SW-C UNIT ***									
PCB with Components						CB1308001			
Printed Circuit Board						FR005880A		1-	
JP9241	WIRE ASSY					T9206853		1-	
JP9242	WIRE ASSY					T9206857		1-	
R 9241	CARBON FILM RES.	220	1/6W	5%	RD16PJ221 220	J01225221		1-	
S 9241	TACT SWITCH				SKQCAE	N5090072		1-	
S 9242	TACT SWITCH				SKHQFM	N5090083		1-	
S 9243	LED				GL8HD25	G2090638		1-	
S 9244	TACT SWITCH				SKHQFM	N5090083		1-	
S 9245	TACT SWITCH				SKHQFM	N5090083		1-	
S 9246	TACT SWITCH				SKHQFM	N5090083		1-	
*** SW-D UNIT ***									
PCB with Components						CB1313001			
Printed Circuit Board						FR006300A		1-	
JP9261	WIRE ASSY					T9206479		1-	
S 9261	TACT SWITCH				SKHQFM	N5090083		1-	
S 9262	TACT SWITCH				SKHQFM	N5090083		1-	
*** SW-E UNIT ***									
Printed Circuit Board						FR006460B		1-	
P 8701	WIRE ASSY					T9206911		1-	
S 8701	TACT SWITCH				SOT-154HST R66-5552	N5090114		1-	
S 8702	TACT SWITCH				SOT-154HST R66-5552	N5090114		1-	

SW-A, B, C, D, E Unit

Note

VR-A Unit Circuit Diagram

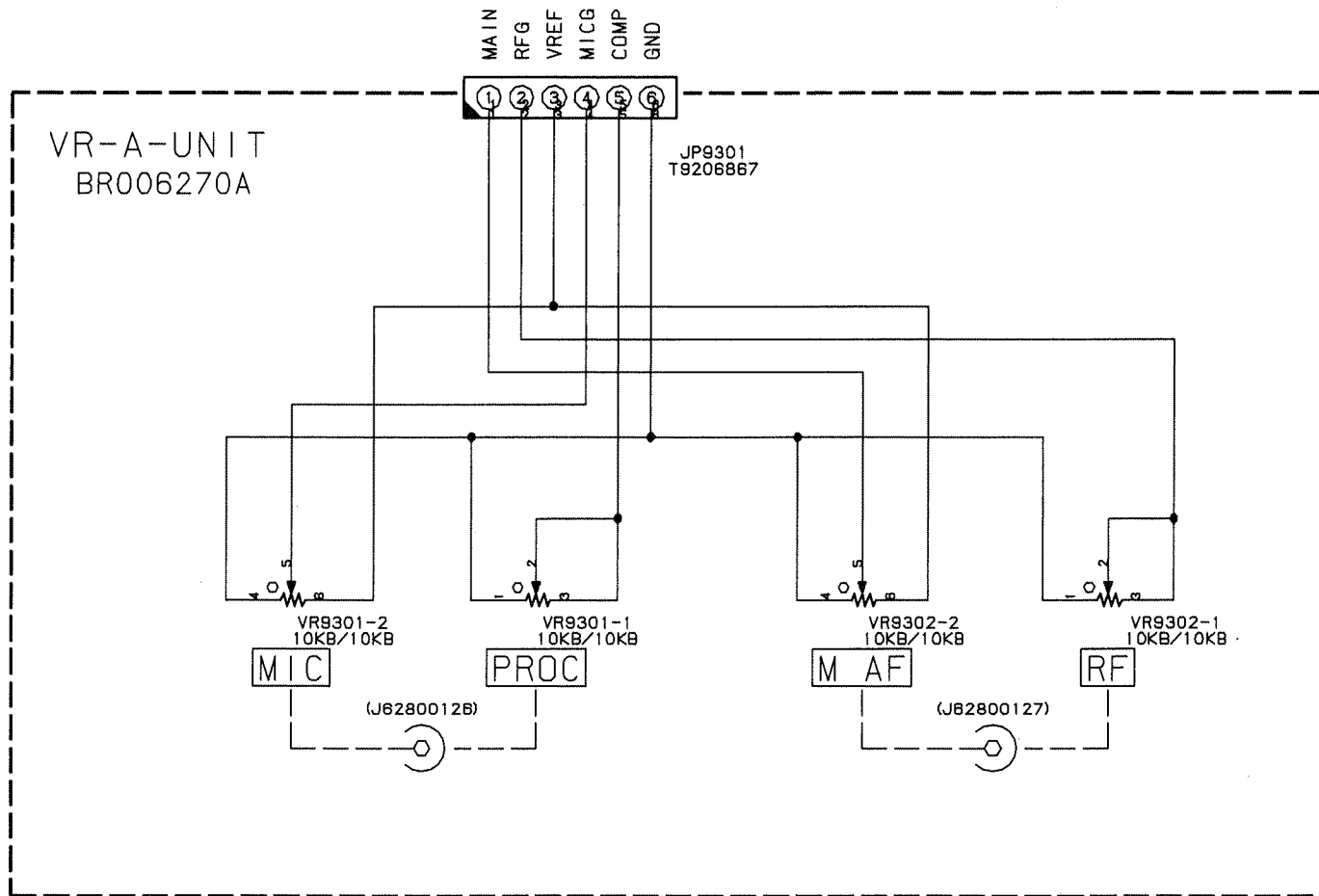

VR-A Unit Parts Layout

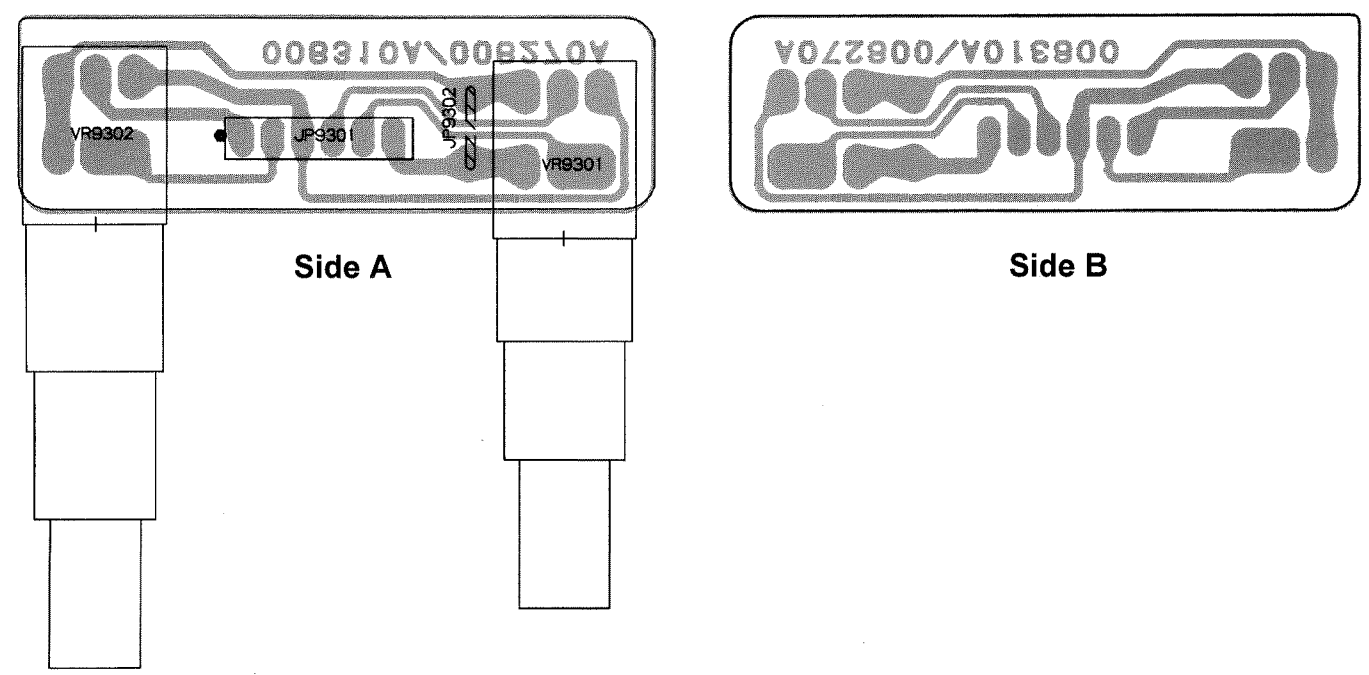

VR-B Unit Circuit Diagram

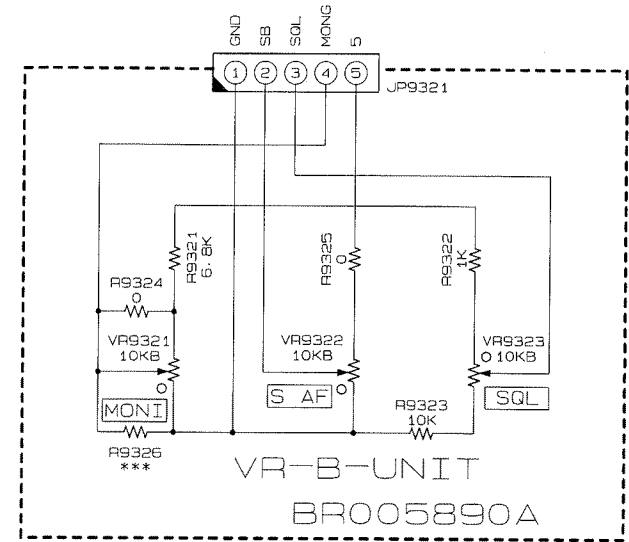

VR-C Unit Circuit Diagram

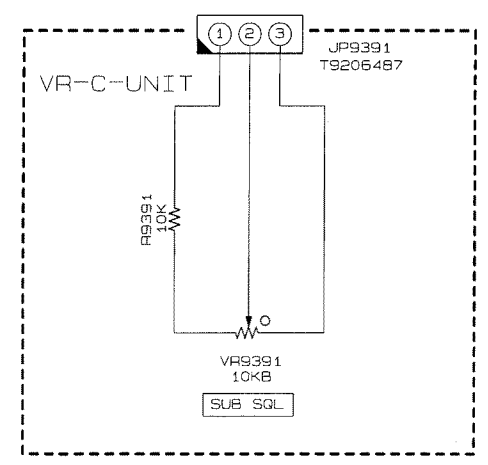

VR-B Unit Parts Layout

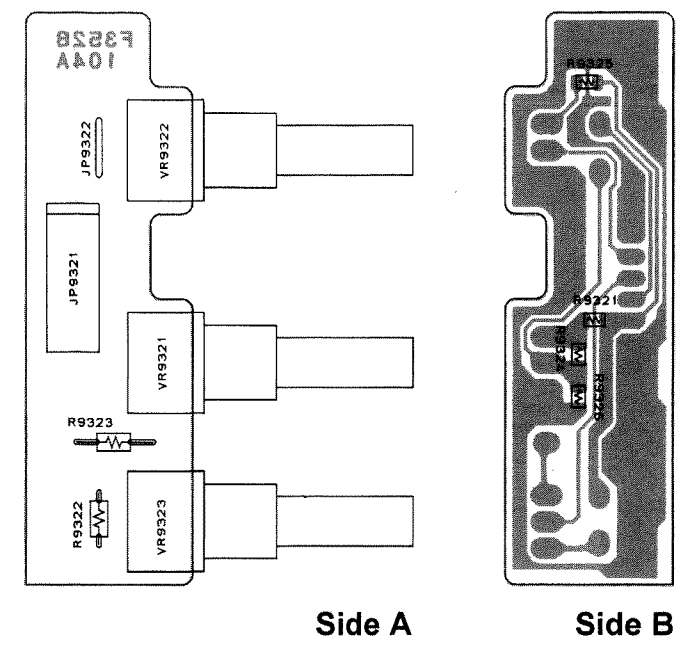

VR-C Unit Parts Layout

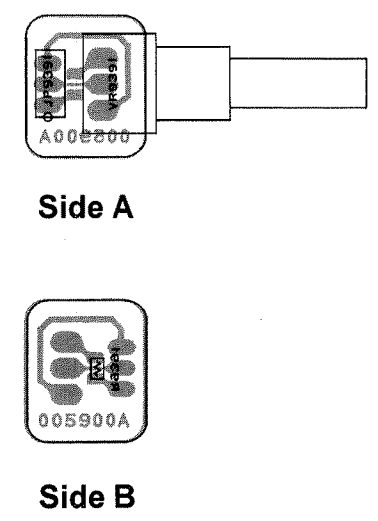

VR-A, B, C, D, E, F Unit

VR-D Unit Circuit Diagram

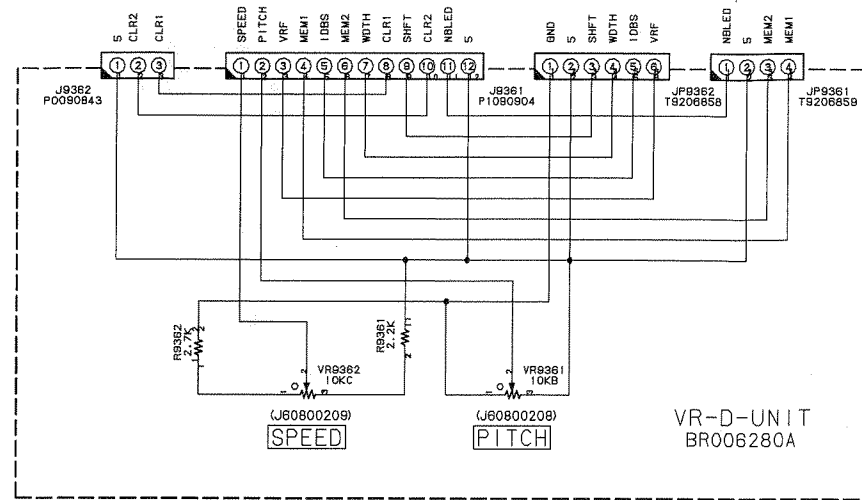

VR-D Unit Parts Layout

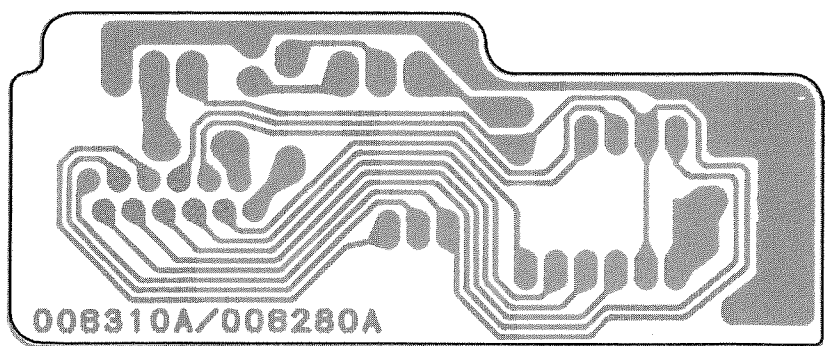
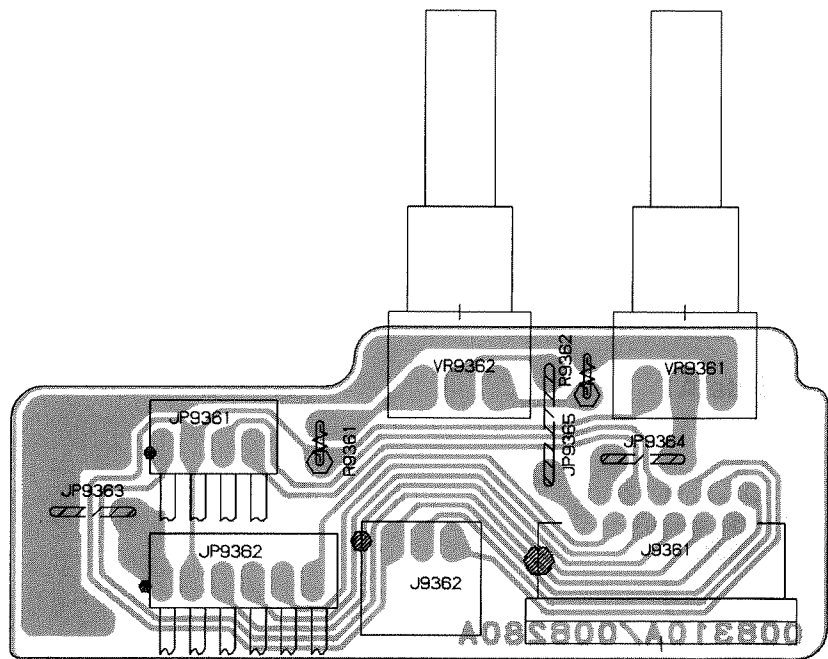

VR-E Unit Circuit Diagram

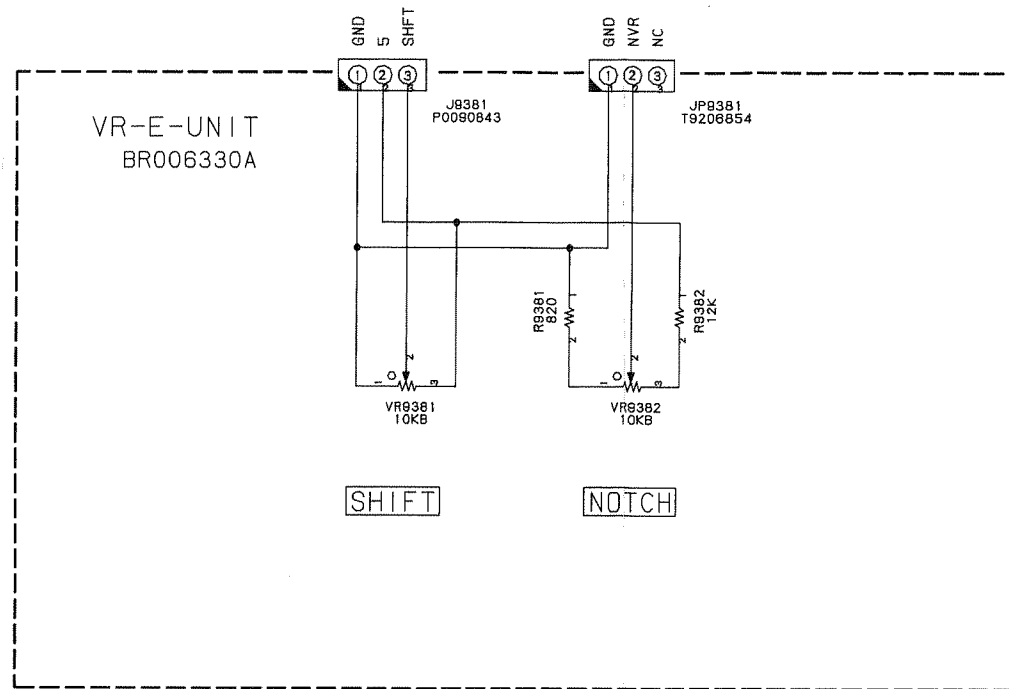

VR-E Unit Parts Layout

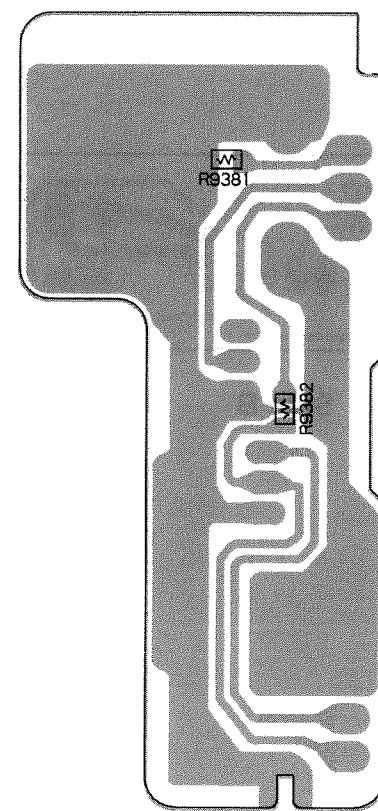
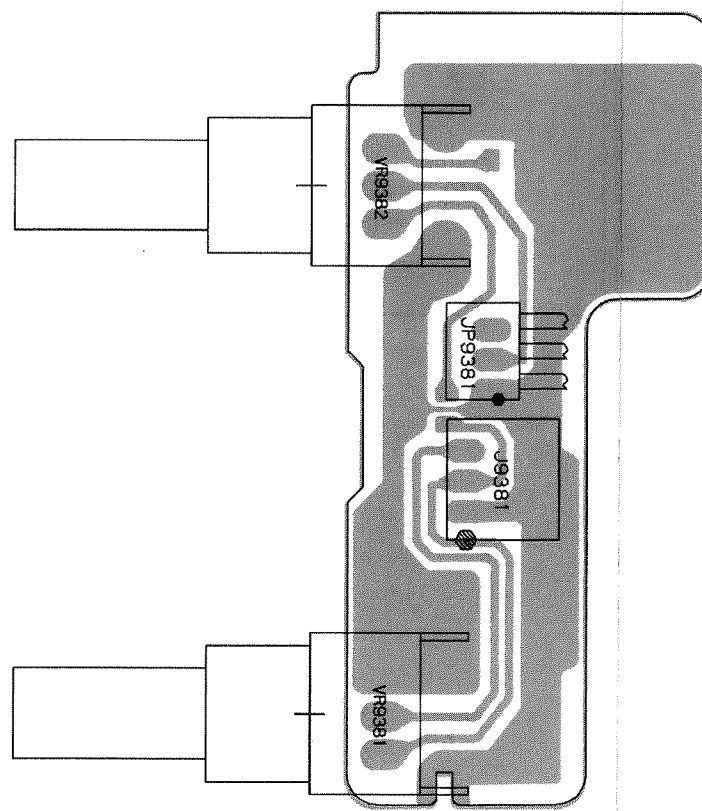

VR-F Unit Circuit Diagram

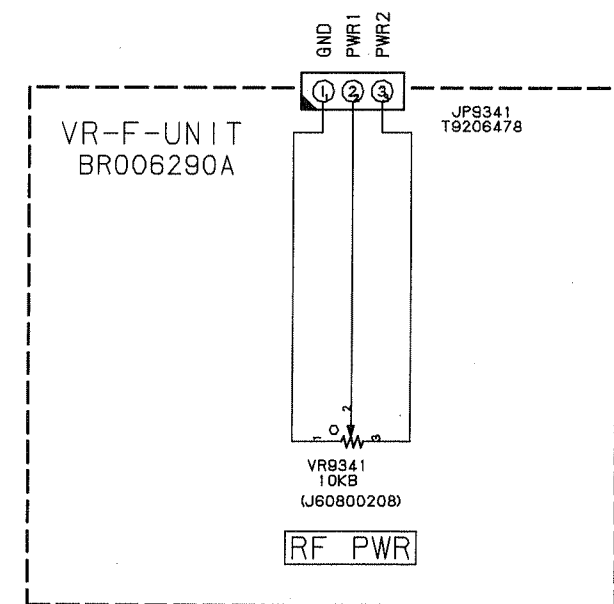

VR-F Unit Parts Layout

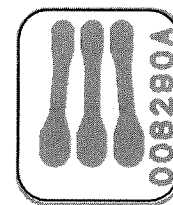
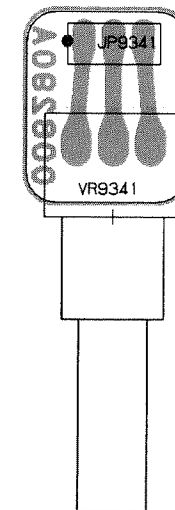

VR-A, B, C, D, E, F Unit

Parts List

REF.	DESCRIPTION	VALUE	V/W	TOL.	MFR'S DESIG	YAESU P/N	VERS.	LOT.	LAY ADR
*** VR-A UNIT ***									
PCB with Components						CB1314001			
Printed Circuit Board						FR006270A		1	
JP9301	WIRE ASSY					T9206867		1	
JP9302	JUMPER WIRE A				0.8-5.0	Q6100003		1	
VR9301	POT.	10k		B	RK097221003WA	J62800126		1	
VR9302	POT.	10k		B	RK097221003YA	J62800127		1	
*** VR-B UNIT ***									
PCB with Components						CB1309001			
Printed Circuit Board						FR005890A		1	
R 9321	CHIP RES.	6.8k	1/10W	5%	RMC1/10T 682J	J24205682		1	
R 9322	CARBON FILM RES.	1k	1/6W	5%	RD16TPJ102 1K	J07225102		1	
R 9323	CARBON FILM RES.	10k	1/6W	5%	RD16TPJ103 10K	J07225103		1	
R 9324	CHIP RES.	0	1/10W	5%	RMC1/10T 000J	J24205000		1	
R 9325	CHIP RES.	0	1/10W	5%	RMC1/10T 000J	J24205000		1	
VR9321	POT.	10k		B	RK09711100WPA	J60800208		1	
VR9322	POT.	10k		B	RK09711100WPA	J60800208		1	
VR9323	POT.	10k		B	RK09711100WPA	J60800208		1	
*** VR-C UNIT ***									
PCB with Components						CB1310001			
Printed Circuit Board						FR005900A		1	
JP9391	WIRE ASSY					T9206487		1	
R 9391	CHIP RES.	10k	1/10W	5%	RMC1/10T 103J	J24205103		1	
VR9391	POT.	10k		B	RK09711100WPA	J60800208		1	
*** VR-D UNIT ***									
PCB with Components						CB1316001			
Printed Circuit Board						FR006280A		1	
J 9361	CONNECTOR				12FMZ-ST	P1090904		1	
J 9362	CONNECTOR				SB20-03WL	P0090843		1	
JP9361	WIRE ASSY				AH006H	T9206859		1	
JP9362	WIRE ASSY				AH006H	T9206858		1	
JP9363	JUMPER WIRE A				0.8-5.0	Q6100003		1	
JP9364	JUMPER WIRE A				0.8-5.0	Q6100003		1	
JP9365	JUMPER WIRE A				0.8-7.5	Q6100004		1	
R 9361	CARBON FILM RES.	2.2k	1/6W	5%	RD16UJ222 2.2K	J02225222		1	
R 9362	CARBON FILM RES.	2.7k	1/6W	5%	RD16UJ272 2.7K	J02225272		1	
VR9361	POT.	10k		B	RK09711100WPA	J60800208		1	
VR9362	POT.	10k		C	RK09711100WS0	J60800209		1	
*** VR-E UNIT ***									
PCB with Components						CB1317001			
Printed Circuit Board						FR006330A		1	
J 9381	CONNECTOR				SB20-03WL	P0090843		1	
JP9381	WIRE ASSY					T9206854		1	
R 9381	CHIP RES.	820	1/10W	5%	RMC1/10T 821J	J24205821		1	
R 9382	CHIP RES.	12k	1/10W	5%	RMC1/10T 123J	J24205123		1	
VR9381	POT.	10k		B	RK09L1120C04	J60800251		1	
VR9382	POT.	10k		B	RK097111060U	J60800252		1	
*** VR-F UNIT ***									
PCB with Components						CB1315001			
Printed Circuit Board						FR006290A		1	
JP9341	WIRE ASSY				A0393	T9206478		1	
VR9341	POT.				RK09711100WPA 10KB	J60800208		1	

VR-A, B, C, D, E, F Unit

Note

ENC-A Unit Circuit Diagram

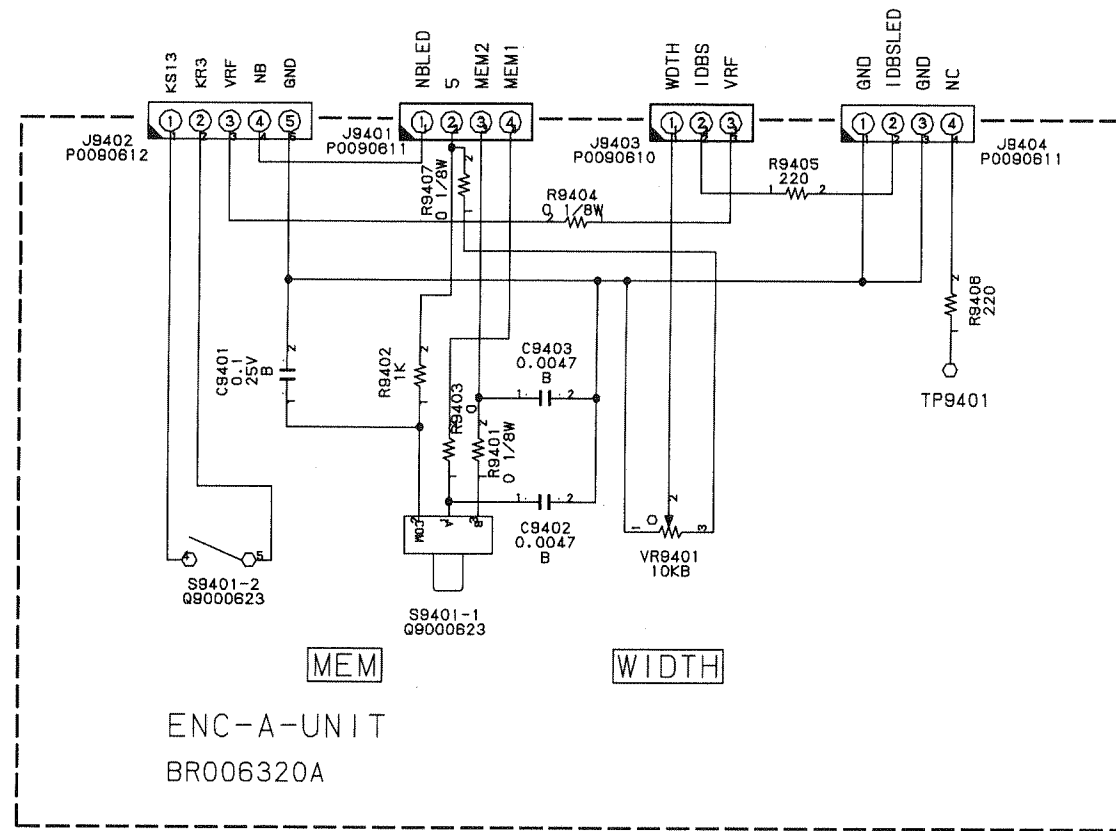

MIC Unit Circuit Diagram

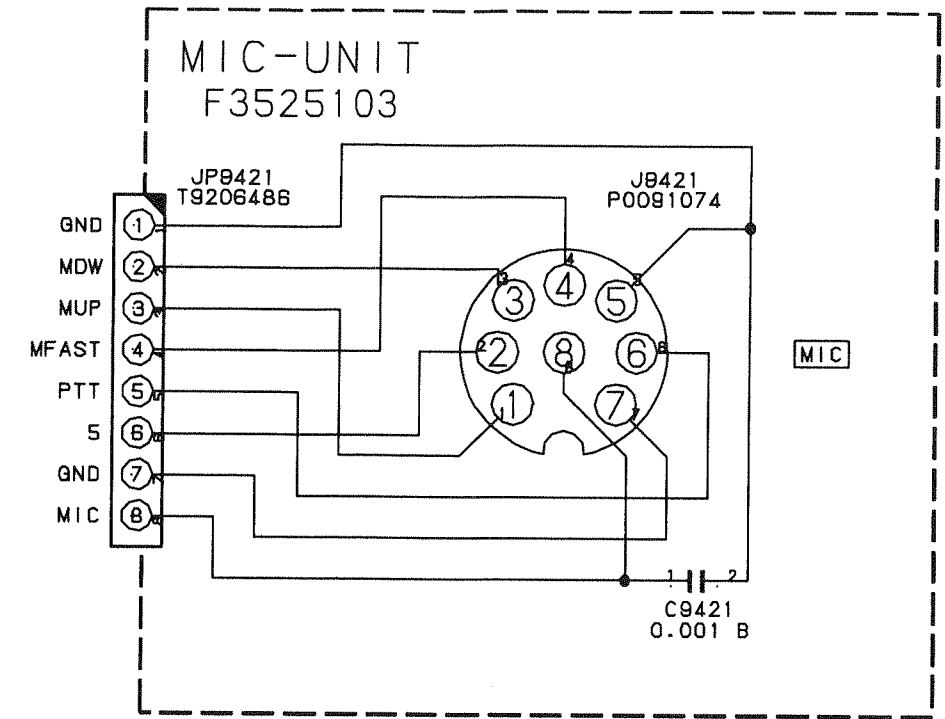

ENC-A Unit Parts Layout

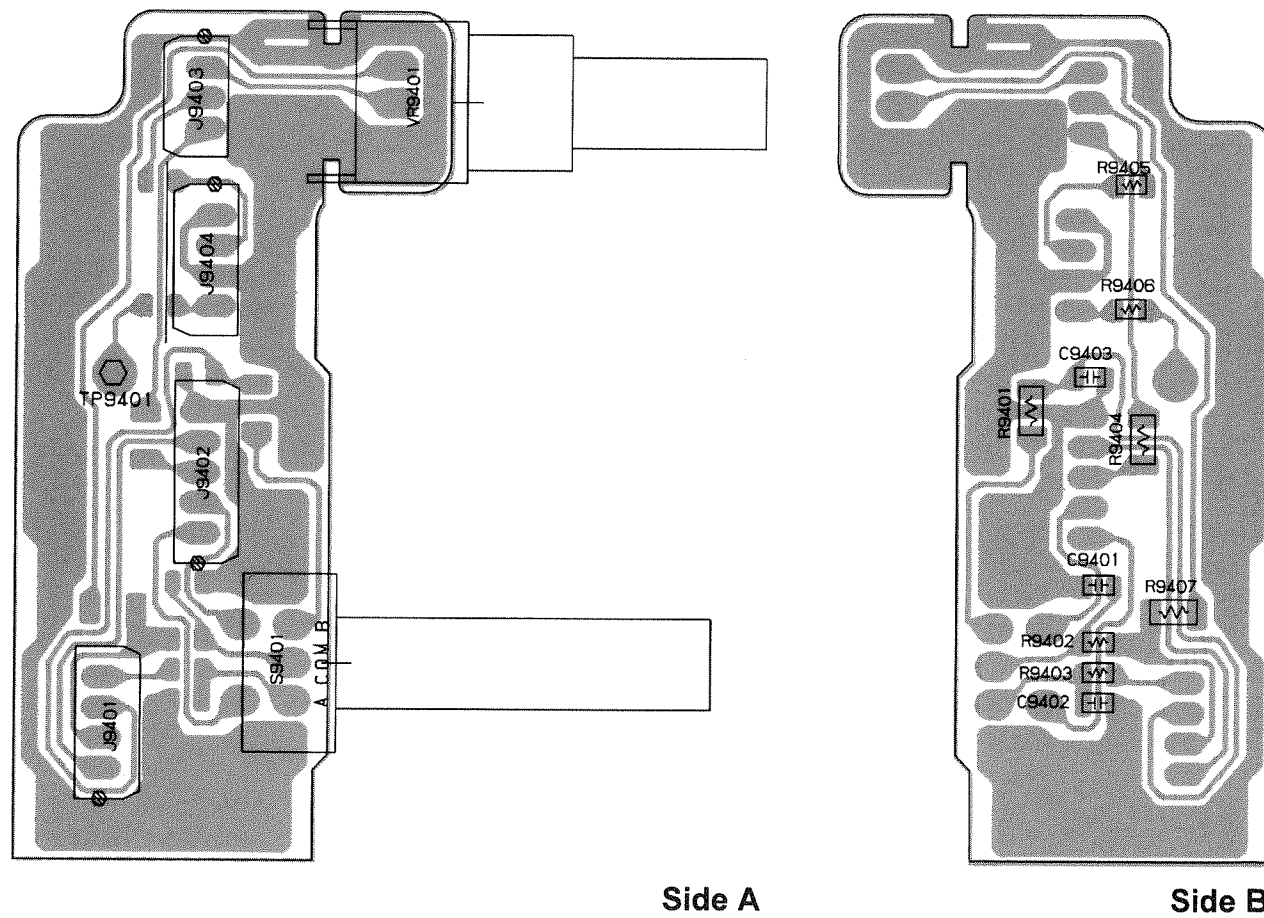

MIC Unit Parts Layout

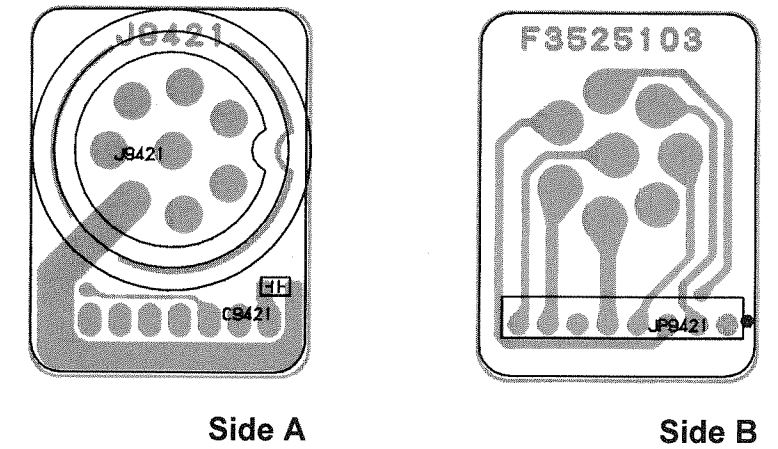

ENC-A, MIC, HP Unit

HP Unit Circuit Diagram

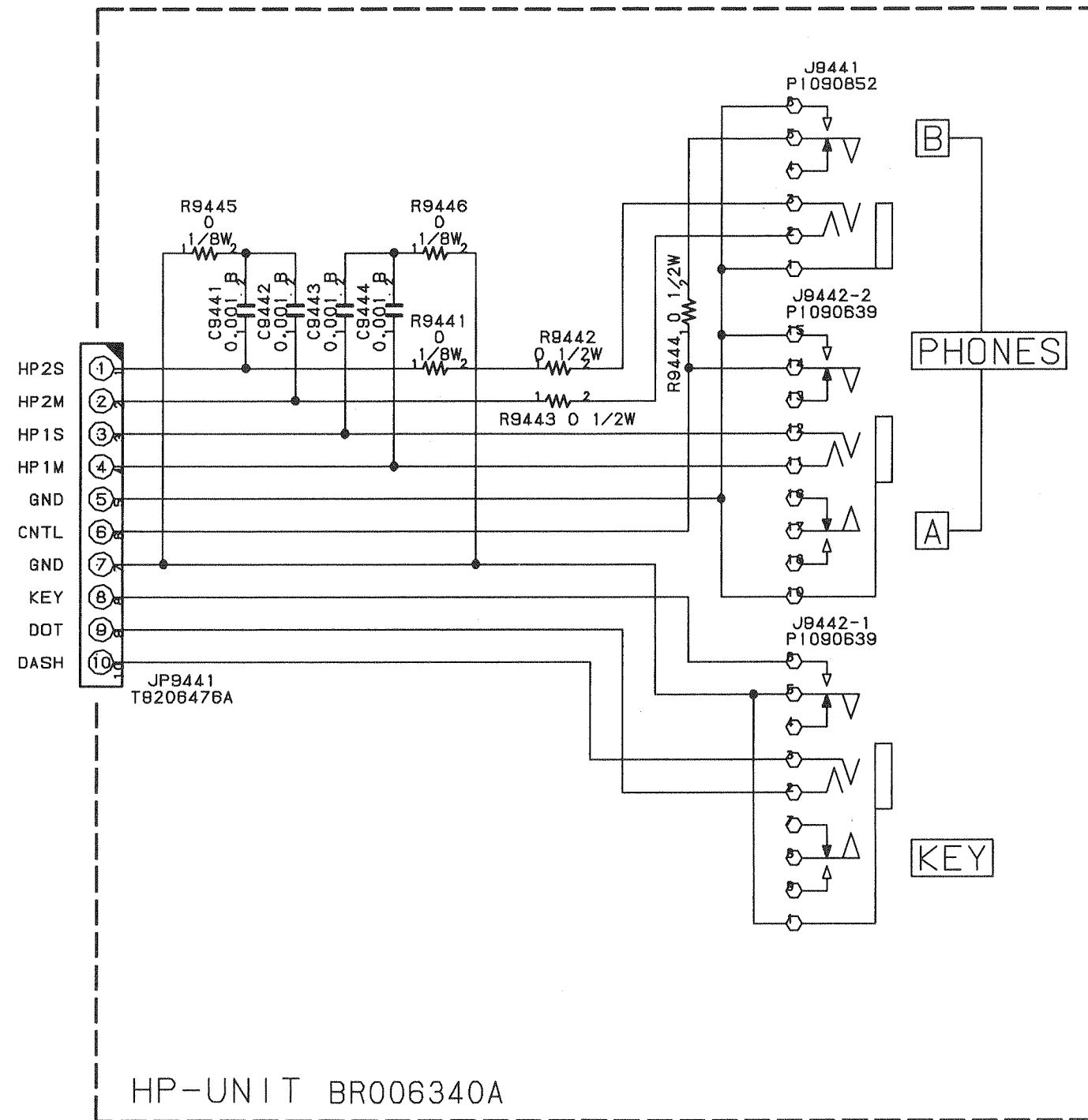

HP Unit Parts Layout

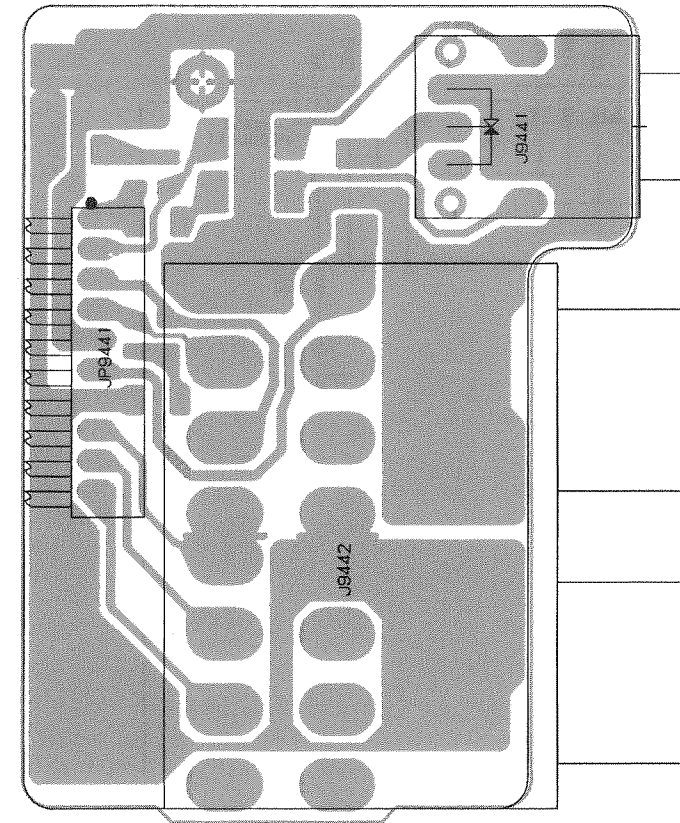

Side A

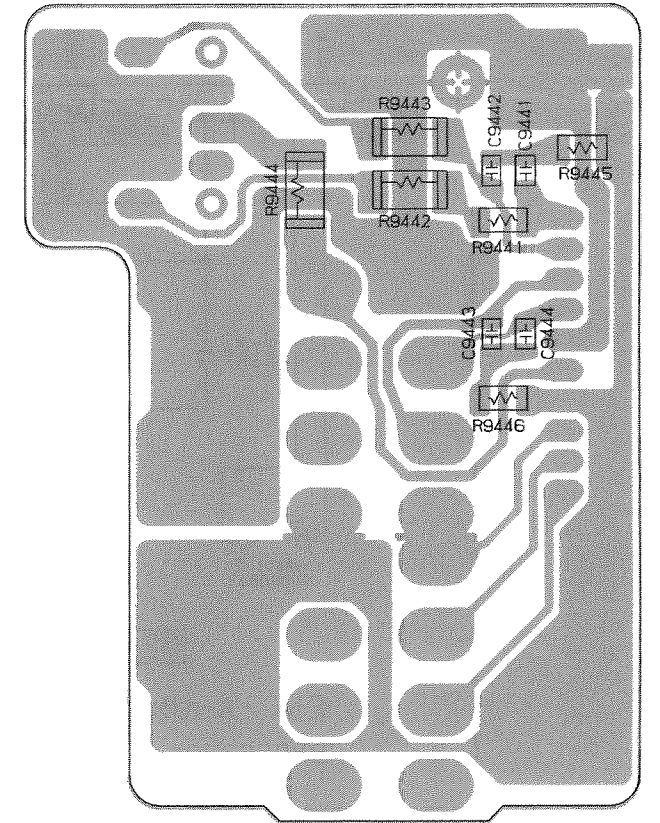

Side B

ENC-A, MIC, HP Unit

Parts List

REF.	DESCRIPTION	VALUE	V/W	TOL.	MFR'S DESIG	YAESU P/N	VERS.	LOT.	LAY ADR
*** ENC-A UNIT ***									
PCB with Components						CB1318001			
Printed Circuit Board						FR006320A		1	
C 9401	CHIP CAP.	0.1uF	25V	B	GRM40B104M25PT	K22140811		1	
C 9402	CHIP CAP.	0.0047uF	50V	B	GRM40B472M50PT	K22170813		1	
C 9403	CHIP CAP.	0.0047uF	50V	B	GRM40B472M50PT	K22170813		1	
J 9401	CONNECTOR				SB20-04WS	P0090611		1	
J 9402	CONNECTOR				SB20-05WS	P0090612		1	
J 9403	CONNECTOR				SB20-03WS	P0090610		1	
J 9404	CONNECTOR				SB20-04WS	P0090611		1	
R 9401	CHIP RES.	0	1/8W	5%	RMC1/8T 000J	J24215000		1	
R 9402	CHIP RES.	1k	1/10W	5%	RMC1/10T 102J	J24205102		1	
R 9403	CHIP RES.	0	1/10W	5%	RMC1/10T 000J	J24205000		1	
R 9404	CHIP RES.	0	1/8W	5%	RMC1/8T 000J	J24215000		1	
R 9405	CHIP RES.	220	1/10W	5%	RMC1/10T 221J	J24205221		1	
R 9406	CHIP RES.	220	1/10W	5%	RMC1/10T 221J	J24205221		1	
R 9407	CHIP RES.	0	1/8W	5%	RMC1/8T 000J	J24215000		1	
S 9401	ROTARY ENCODER				EC11B15242	Q9000623		1	
VR9401	POT.	10k		B	RK09L1120C04	J60800251		1	
*** MIC UNIT ***									
PCB with Components						CB1319001			
Printed Circuit Board						F3525103		1	
C 9421	CHIP CAP.	0.001uF	50V	B	GRM40B102M50PT	K22170805		1	
J 9421	CONNECTOR				FM214-8SMPT-NI	P0091074		1	
JP9421	WIRE ASSY				A0393	T9206486		1	
*** HP UNIT ***									
PCB with Components						CB1320001			
Printed Circuit Board						FR006340A		1	
C 9441	CHIP CAP.	0.001uF	50V	B	GRM40B102M50PT	K22170805		1	
C 9442	CHIP CAP.	0.001uF	50V	B	GRM40B102M50PT	K22170805		1	
C 9443	CHIP CAP.	0.001uF	50V	B	GRM40B102M50PT	K22170805		1	
C 9444	CHIP CAP.	0.001uF	50V	B	GRM40B102M50PT	K22170805		1	
J 9441	CONNECTOR				HSJ0917-01-140	P1090852		1	
J 9442	CONNECTOR				HLJ2335-01-3010	P1090639		1	
JP9441	WIRE ASSY				A0393	T9206476A		1	
R 9441	CHIP RES.	0	1/8W	5%	RMC1/8T 000J	J24215000		1	
R 9442	CHIP RES.	0	1/2W	5%	RMC1/2 JPATE	J24275000		1	
R 9443	CHIP RES.	0	1/2W	5%	RMC1/2 JPATE	J24275000		1	
R 9444	CHIP RES.	0	1/2W	5%	RMC1/2 JPATE	J24275000		1	
R 9445	CHIP RES.	0	1/8W	5%	RMC1/8T 000J	J24215000		1	
R 9446	CHIP RES.	0	1/8W	5%	RMC1/8T 000J	J24215000		1	

ENC-A, MIC, HP Unit

Note

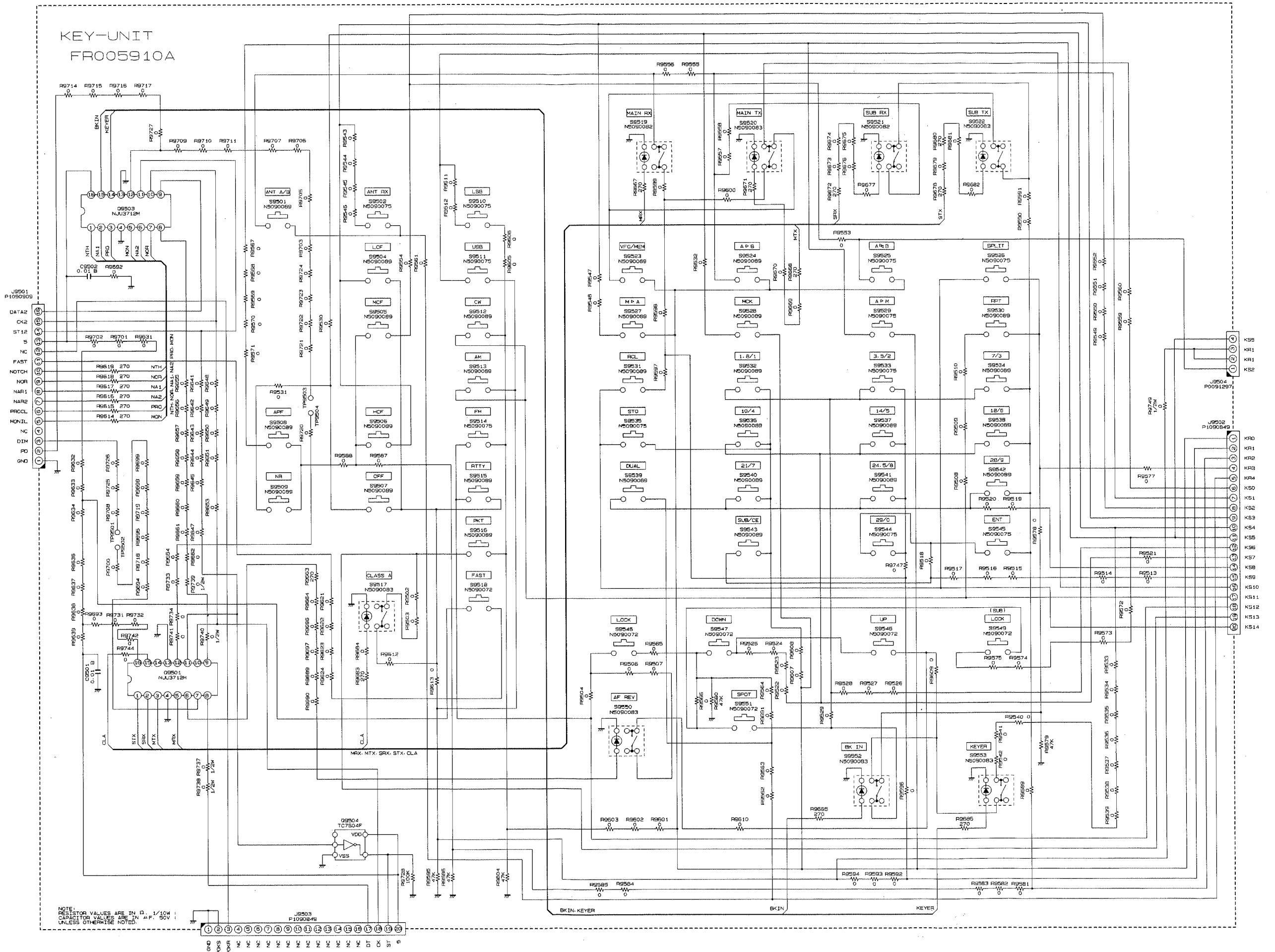

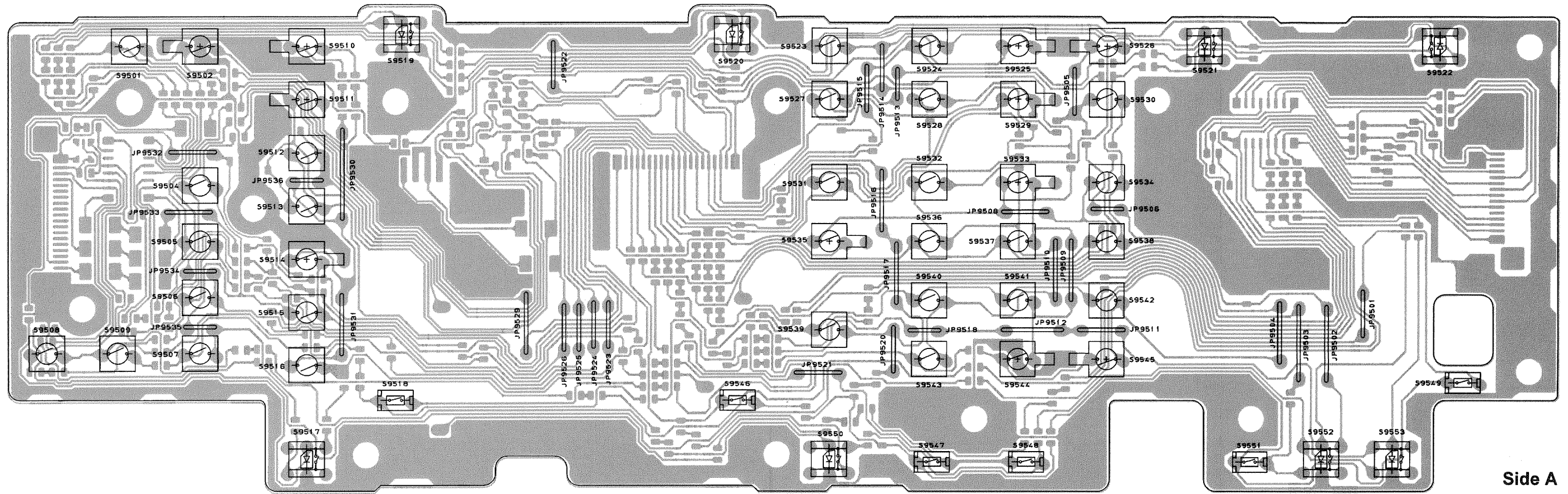

Side A

KEY Unit

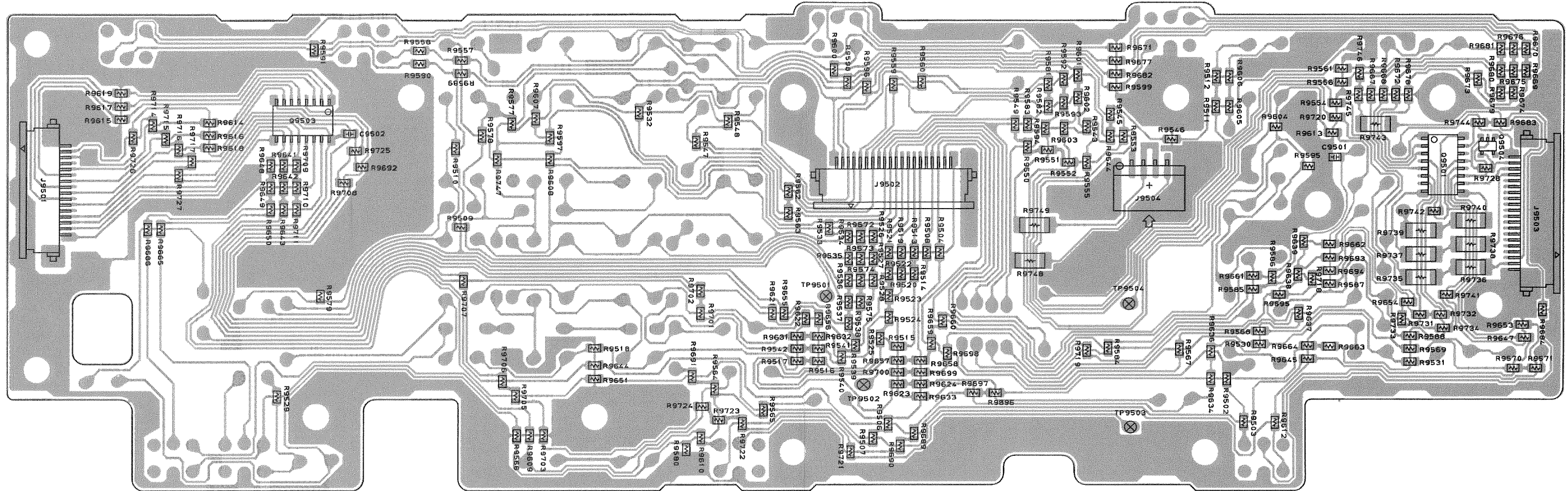

Side B

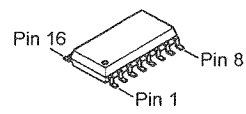

NJU3712M
(Q9501, 9503)

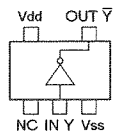

TC7S04F (E5)
(Q9504)

KEY Unit

Parts List

REF.	DESCRIPTION	VALUE	V/W	TOL.	MFR'S DESIG	YAESU P/N	VERS.	LOT.	LAYADR
PCB with Components						CB1311001	W/CE LABEL		
PCB with Components						CB1311002	W/CE LABEL		
Printed Circuit Board						FR005910A		1-	
C 9501	CHIPCAP.	0.01uF	50V	B	GRM40B103M50PT	K22170817		1-	
C 9502	CHIPCAP.	0.01uF	50V	B	GRM40B103M50PT	K22170817		1-	
D 9501	DIODE				RD5.6EB2	G2090156	W/CE LABEL	10-	
D 9502	DIODE				RD5.6EB2	G2090156	W/CE LABEL	10-	
D 9503	DIODE				RD5.6EB2	G2090156	W/CE LABEL	10-	
J 9501	CONNECTOR				52270-1617	P1090909		1-	
J 9502	CONNECTOR				52270-2017	P1090849		1-	
J 9503	CONNECTOR				52270-2017	P1090849		1-	
J 9504	CONNECTOR				S4B-PH-SM3-TB	P0091297		1-	
JP9501	WIRE ASSY				GRN 20 2/2	T50502000		1-	
JP9502	WIRE ASSY				GRN 25 2/2	T50502500		1-	
JP9503	WIRE ASSY				GRN 30 2/2	T50503000		1-	
JP9504	WIRE ASSY				GRN 230 2/2	T50523000		1-	
Q 9501	IC				NJU3712M(Te1)	G1092934		1-	
Q 9503	IC				NJU3712M(Te1)	G1092934		1-	
Q 9504	IC				TC7S04F TE85R	G1091444		1-	
R 9502	CHIPRES.	0	1/10W	5%	RMC1/10T 000J	J24205000		1-	
R 9503	CHIPRES.	0	1/10W	5%	RMC1/10T 000J	J24205000		1-	
R 9504	CHIPRES.	0	1/10W	5%	RMC1/10T 000J	J24205000		1-	
R 9506	CHIPRES.	0	1/10W	5%	RMC1/10T 000J	J24205000		1-	
R 9507	CHIPRES.	0	1/10W	5%	RMC1/10T 000J	J24205000		1-	
R 9508	CHIPRES.	0	1/10W	5%	RMC1/10T 000J	J24205000		1-	
R 9509	CHIPRES.	0	1/10W	5%	RMC1/10T 000J	J24205000		1-	
R 9510	CHIPRES.	0	1/10W	5%	RMC1/10T 000J	J24205000		1-	
R 9511	CHIPRES.	0	1/10W	5%	RMC1/10T 000J	J24205000		1-	
R 9512	CHIPRES.	0	1/10W	5%	RMC1/10T 000J	J24205000		1-	
R 9513	CHIPRES.	0	1/10W	5%	RMC1/10T 000J	J24205000		1-	
R 9514	CHIPRES.	0	1/10W	5%	RMC1/10T 000J	J24205000		1-	
R 9515	CHIPRES.	0	1/10W	5%	RMC1/10T 000J	J24205000		1-	
R 9516	CHIPRES.	0	1/10W	5%	RMC1/10T 000J	J24205000		1-	
R 9517	CHIPRES.	0	1/10W	5%	RMC1/10T 000J	J24205000		1-	
R 9518	CHIPRES.	0	1/10W	5%	RMC1/10T 000J	J24205000		1-	
R 9519	CHIPRES.	0	1/10W	5%	RMC1/10T 000J	J24205000		1-	
R 9520	CHIPRES.	0	1/10W	5%	RMC1/10T 000J	J24205000		1-	
R 9521	CHIPRES.	0	1/10W	5%	RMC1/10T 000J	J24205000		1-	
R 9522	CHIPRES.	0	1/10W	5%	RMC1/10T 000J	J24205000		1-	
R 9523	CHIPRES.	0	1/10W	5%	RMC1/10T 000J	J24205000		1-	
R 9524	CHIPRES.	0	1/10W	5%	RMC1/10T 000J	J24205000		1-	
R 9525	CHIPRES.	0	1/10W	5%	RMC1/10T 000J	J24205000		1-	
R 9526	CHIPRES.	0	1/10W	5%	RMC1/10T 000J	J24205000		1-	
R 9527	CHIPRES.	0	1/10W	5%	RMC1/10T 000J	J24205000		1-	
R 9528	CHIPRES.	0	1/10W	5%	RMC1/10T 000J	J24205000		1-	
R 9529	CHIPRES.	0	1/10W	5%	RMC1/10T 000J	J24205000		1-	
R 9530	CHIPRES.	0	1/10W	5%	RMC1/10T 000J	J24205000		1-	
R 9531	CHIPRES.	0	1/10W	5%	RMC1/10T 000J	J24205000		1-	
R 9532	CHIPRES.	0	1/10W	5%	RMC1/10T 000J	J24205000		1-	
R 9533	CHIPRES.	0	1/10W	5%	RMC1/10T 000J	J24205000		1-	
R 9534	CHIPRES.	0	1/10W	5%	RMC1/10T 000J	J24205000		1-	
R 9535	CHIPRES.	0	1/10W	5%	RMC1/10T 000J	J24205000		1-	
R 9536	CHIPRES.	0	1/10W	5%	RMC1/10T 000J	J24205000		1-	
R 9537	CHIPRES.	0	1/10W	5%	RMC1/10T 000J	J24205000		1-	
R 9538	CHIPRES.	0	1/10W	5%	RMC1/10T 000J	J24205000		1-	
R 9539	CHIPRES.	0	1/10W	5%	RMC1/10T 000J	J24205000		1-	
R 9540	CHIPRES.	0	1/10W	5%	RMC1/10T 000J	J24205000		1-	
R 9541	CHIPRES.	0	1/10W	5%	RMC1/10T 000J	J24205000		1-	
R 9542	CHIPRES.	0	1/10W	5%	RMC1/10T 000J	J24205000		1-	
R 9543	CHIPRES.	0	1/10W	5%	RMC1/10T 000J	J24205000		1-	
R 9544	CHIPRES.	0	1/10W	5%	RMC1/10T 000J	J24205000		1-	
R 9545	CHIPRES.	0	1/10W	5%	RMC1/10T 000J	J24205000		1-	
R 9546	CHIPRES.	0	1/10W	5%	RMC1/10T 000J	J24205000		1-	
R 9547	CHIPRES.	0	1/10W	5%	RMC1/10T 000J	J24205000		1-	
R 9548	CHIPRES.	0	1/10W	5%	RMC1/10T 000J	J24205000		1-	
R 9549	CHIPRES.	0	1/10W	5%	RMC1/10T 000J	J24205000		1-	
R 9550	CHIPRES.	0	1/10W	5%	RMC1/10T 000J	J24205000		1-	
R 9551	CHIPRES.	0	1/10W	5%	RMC1/10T 000J	J24205000		1-	

KEY Unit

Parts List

REF.	DESCRIPTION	VALUE	V/W	TOL.	MFR'S DESIG	YAESU P/N	VERS.	LOT.	LAY ADR
R 9706	CHIPRES.	0	1/10W	5%	RMC1/10T 000J	J24205000		1-	
R 9707	CHIPRES.	0	1/10W	5%	RMC1/10T 000J	J24205000		1-	
R 9708	CHIPRES.	0	1/10W	5%	RMC1/10T 000J	J24205000		1-	
R 9709	CHIPRES.	0	1/10W	5%	RMC1/10T 000J	J24205000		1-	
R 9710	CHIPRES.	0	1/10W	5%	RMC1/10T 000J	J24205000		1-	
R 9711	CHIPRES.	0	1/10W	5%	RMC1/10T 000J	J24205000		1-	
R 9714	CHIPRES.	0	1/10W	5%	RMC1/10T 000J	J24205000		1-	
R 9715	CHIPRES.	0	1/10W	5%	RMC1/10T 000J	J24205000		1-	
R 9716	CHIPRES.	0	1/10W	5%	RMC1/10T 000J	J24205000		1-	
R 9717	CHIPRES.	0	1/10W	5%	RMC1/10T 000J	J24205000		1-	
R 9718	CHIPRES.	0	1/10W	5%	RMC1/10T 000J	J24205000		1-	
R 9719	CHIPRES.	0	1/10W	5%	RMC1/10T 000J	J24205000		1-	
R 9720	CHIPRES.	0	1/10W	5%	RMC1/10T 000J	J24205000		1-	
R 9721	CHIPRES.	0	1/10W	5%	RMC1/10T 000J	J24205000		1-	
R 9722	CHIPRES.	0	1/10W	5%	RMC1/10T 000J	J24205000		1-	
R 9723	CHIPRES.	0	1/10W	5%	RMC1/10T 000J	J24205000		1-	
R 9724	CHIPRES.	0	1/10W	5%	RMC1/10T 000J	J24205000		1-	
R 9725	CHIPRES.	0	1/10W	5%	RMC1/10T 000J	J24205000		1-	
R 9726	CHIPRES.	0	1/10W	5%	RMC1/10T 000J	J24205000		1-	
R 9727	CHIPRES.	0	1/10W	5%	RMC1/10T 000J	J24205000		1-	
R 9728	CHIPRES.	100k	1/10W	5%	RMC1/10T 104J	J24205104		1-	
R 9731	CHIPRES.	0	1/10W	5%	RMC1/10T 000J	J24205000		1-	
R 9732	CHIPRES.	0	1/10W	5%	RMC1/10T 000J	J24205000		1-	
R 9733	CHIPRES.	0	1/10W	5%	RMC1/10T 000J	J24205000		1-	
R 9734	CHIPRES.	0	1/10W	5%	RMC1/10T 000J	J24205000		1-	
R 9737	CHIPRES.	0	1/2W	5%	RMC1/2JPATE	J24275000		1-	
R 9738	CHIPRES.	0	1/2W	5%	RMC1/2JPATE	J24275000		1-	
R 9739	CHIPRES.	0	1/2W	5%	RMC1/2JPATE	J24275000		1-	
R 9740	CHIPRES.	0	1/2W	5%	RMC1/2JPATE	J24275000		1-	
R 9741	CHIPRES.	0	1/10W	5%	RMC1/10T 000J	J24205000		1-	
R 9742	CHIPRES.	0	1/10W	5%	RMC1/10T 000J	J24205000		1-	
R 9744	CHIPRES.	0	1/10W	5%	RMC1/10T 000J	J24205000		1-	
R 9747	CHIPRES.	0	1/10W	5%	RMC1/10T 000J	J24205000		1-	
R 9749	CHIPRES.	0	1/2W	5%	RMC1/2JPATE	J24275000		1-	
S 9501	TACTSWITCH				SKHVBL	N5090089		1-	
S 9502	TACTSWITCH				SKHVPL	N5090075		1-	
S 9504	TACTSWITCH				SKHVBL	N5090089		1-	
S 9505	TACTSWITCH				SKHVBL	N5090089		1-	
S 9506	TACTSWITCH				SKHVBL	N5090089		1-	
S 9507	TACTSWITCH				SKHVBL	N5090089		1-	
S 9508	TACTSWITCH				SKHVBL	N5090089		1-	
S 9509	TACTSWITCH				SKHVBL	N5090089		1-	
S 9510	TACTSWITCH				SKHVPL	N5090075		1-	
S 9511	TACTSWITCH				SKHVPL	N5090075		1-	
S 9512	TACTSWITCH				SKHVBL	N5090089		1-	
S 9513	TACTSWITCH				SKHVBL	N5090089		1-	
S 9514	TACTSWITCH				SKHVPL	N5090075		1-	
S 9515	TACTSWITCH				SKHVBL	N5090089		1-	
S 9516	TACTSWITCH				SKHVBL	N5090089		1-	
S 9517	TACTSWITCH				SKHQFM	N5090083		1-	
S 9518	TACTSWITCH				SKQCAE	N5090072		1-	
S 9519	TACTSWITCH				SKHQFN	N5090082		1-	
S 9520	TACTSWITCH				SKHQFM	N5090083		1-	
S 9521	TACTSWITCH				SKHQFN	N5090082		1-	
S 9522	TACTSWITCH				SKHQFM	N5090083		1-	
S 9523	TACTSWITCH				SKHVBL	N5090089		1-	
S 9524	TACTSWITCH				SKHVBL	N5090089		1-	
S 9525	TACTSWITCH				SKHVPL	N5090075		1-	
S 9526	TACTSWITCH				SKHVPL	N5090075		1-	
S 9527	TACTSWITCH				SKHVBL	N5090089		1-	
S 9528	TACTSWITCH				SKHVBL	N5090089		1-	
S 9529	TACTSWITCH				SKHVPL	N5090075		1-	
S 9530	TACTSWITCH				SKHVBL	N5090089		1-	
S 9531	TACTSWITCH				SKHVBL	N5090089		1-	
S 9532	TACTSWITCH				SKHVBL	N5090089		1-	
S 9533	TACTSWITCH				SKHVPL	N5090075		1-	
S 9534	TACTSWITCH				SKHVBL	N5090089		1-	
S 9535	TACTSWITCH				SKHVPL	N5090075		1-	

KEY Unit

Parts List

REF.	DESCRIPTION	VALUE	V/W	TOL.	MFR'S DESIG	YAESU P/N	VERS.	LOT.	LAYADR
S 9536	TACTSWITCH				SKHVBL	N5090089		1-	
S 9537	TACTSWITCH				SKHVBL	N5090089		1-	
S 9538	TACTSWITCH				SKHVBL	N5090089		1-	
S 9539	TACTSWITCH				SKHVBL	N5090089		1-	
S 9540	TACTSWITCH				SKHVBL	N5090089		1-	
S 9541	TACTSWITCH				SKHVBL	N5090089		1-	
S 9542	TACTSWITCH				SKHVBL	N5090089		1-	
S 9543	TACTSWITCH				SKHVBL	N5090089		1-	
S 9544	TACTSWITCH				SKHVPL	N5090075		1-	
S 9545	TACTSWITCH				SKHVPL	N5090075		1-	
S 9546	TACTSWITCH				SKQCAE	N5090072		1-	
S 9547	TACTSWITCH				SKQCAE	N5090072		1-	
S 9548	TACTSWITCH				SKQCAE	N5090072		1-	
S 9549	TACTSWITCH				SKQCAE	N5090072		1-	
S 9550	TACTSWITCH				SKHQFM	N5090083		1-	
S 9551	TACTSWITCH				SKQCAE	N5090072		1-	
S 9552	TACTSWITCH				SKHQFM	N5090083		1-	
S 9553	TACTSWITCH				SKHQFM	N5090083		1-	

KEY Unit

Note

LED Unit

Parts Layout

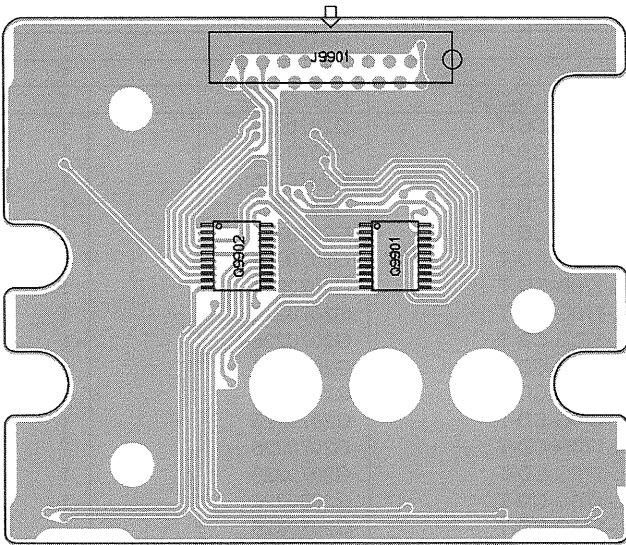

Side A

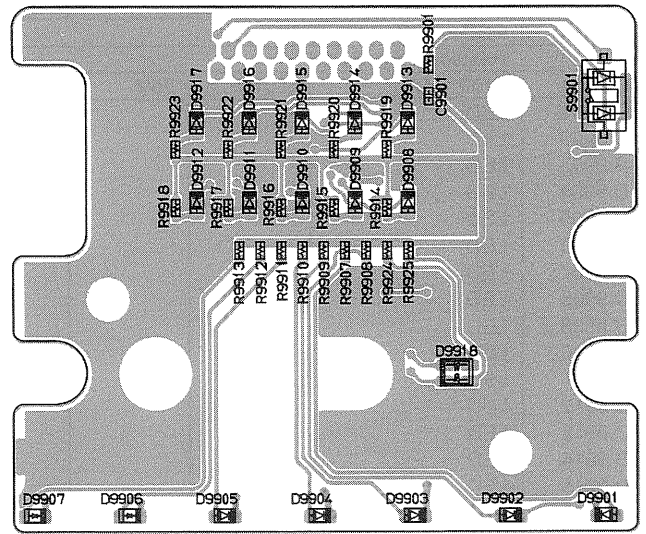

Side B

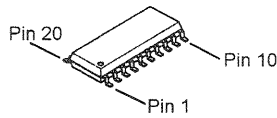

BU2099FV-E2
(Q 9901, Q 9902)

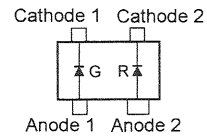

SML-020MLTT86
(D9918)

Parts Diagram

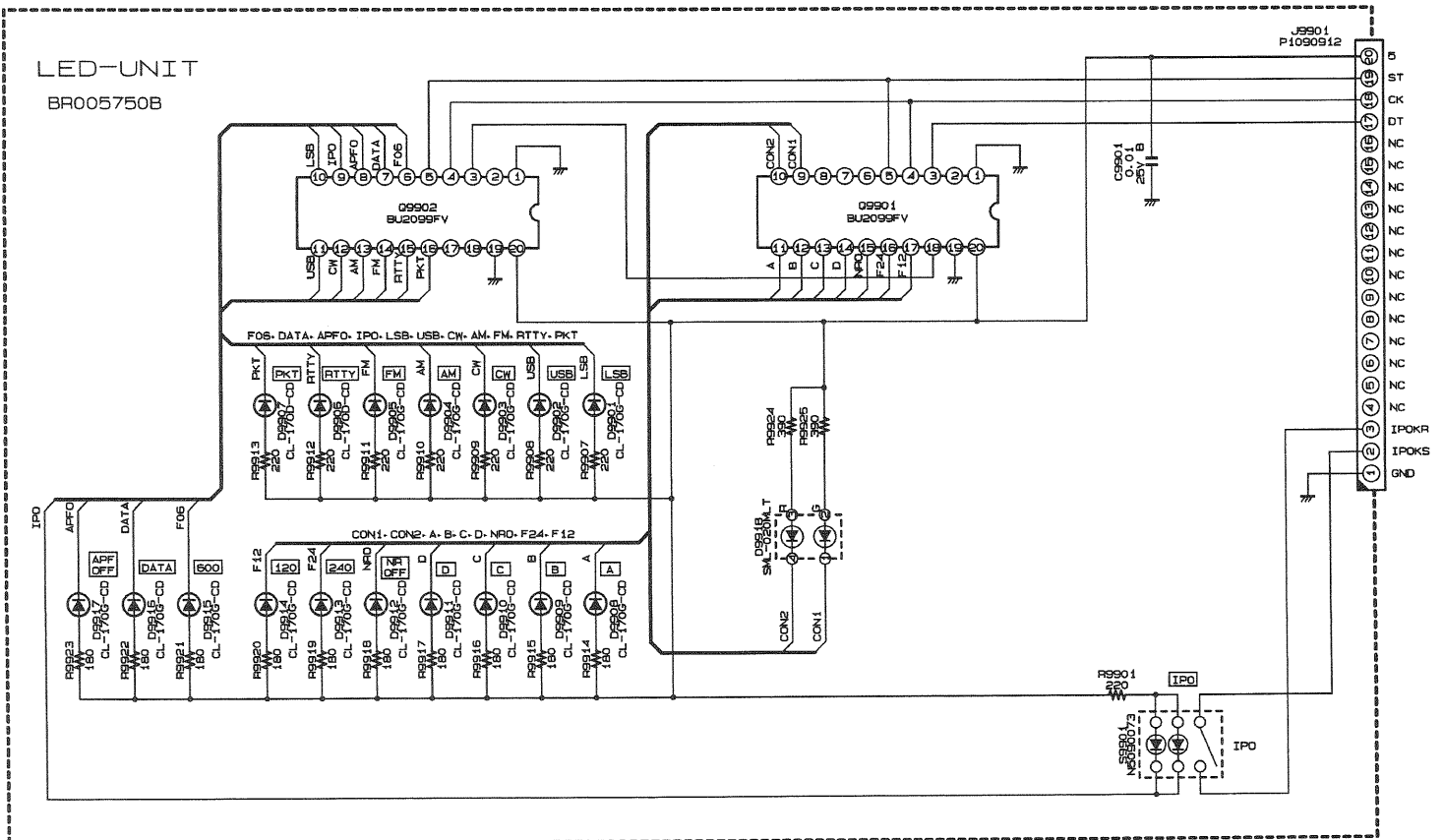

LED Unit

Parts List

REF.	DESCRIPTION	VALUE	V/W	TOL.	MFR'S DESIG	YAESU P/N	VERS.	LOT.	LAY ADR
PCB with Components						CB1292001			
Printed Circuit Board						FR005750B		1	
C 9901	CHIP CAP.	0.01uF	25V	B	GRM39B103J25PT	K22144809		1	
D 9901	LED				CL-170G-CD-T	G2070226		1	
D 9902	LED				CL-170G-CD-T	G2070226		1	
D 9903	LED				CL-170G-CD-T	G2070226		1	
D 9904	LED				CL-170G-CD-T	G2070226		1	
D 9905	LED				CL-170G-CD-T	G2070226		1	
D 9906	LED				CL-170D-CD-T	G2070344		1	
D 9907	LED				CL-170D-CD-T	G2070344		1	
D 9908	LED				CL-170G-CD-T	G2070226		1	
D 9909	LED				CL-170G-CD-T	G2070226		1	
D 9910	LED				CL-170G-CD-T	G2070226		1	
D 9911	LED				CL-170G-CD-T	G2070226		1	
D 9912	LED				CL-170G-CD-T	G2070226		1	
D 9913	LED				CL-170G-CD-T	G2070226		1	
D 9914	LED				CL-170G-CD-T	G2070226		1	
D 9915	LED				CL-170G-CD-T	G2070226		1	
D 9916	LED				CL-170G-CD-T	G2070226		1	
D 9917	LED				CL-170G-CD-T	G2070226		1	
D 9918	LED				SML-020MLTT86	G2070526		1	
J 9901	CONNECTOR				52234-2010	P1090912		1	
Q 9901	IC				BU2099FV-E2	G1093243		1	
Q 9902	IC				BU2099FV-E2	G1093243		1	
R 9901	CHIP RES.	220	1/16W	5%	RMC1/16 221JATP	J24185221		1	
R 9907	CHIP RES.	220	1/16W	5%	RMC1/16 221JATP	J24185221		1	
R 9908	CHIP RES.	220	1/16W	5%	RMC1/16 221JATP	J24185221		1	
R 9909	CHIP RES.	220	1/16W	5%	RMC1/16 221JATP	J24185221		1	
R 9910	CHIP RES.	220	1/16W	5%	RMC1/16 221JATP	J24185221		1	
R 9911	CHIP RES.	220	1/16W	5%	RMC1/16 221JATP	J24185221		1	
R 9912	CHIP RES.	220	1/16W	5%	RMC1/16 221JATP	J24185221		1	
R 9913	CHIP RES.	220	1/16W	5%	RMC1/16 221JATP	J24185221		1	
R 9914	CHIP RES.	180	1/16W	5%	RMC1/16 181JATP	J24185181		1	
R 9915	CHIP RES.	180	1/16W	5%	RMC1/16 181JATP	J24185181		1	
R 9916	CHIP RES.	180	1/16W	5%	RMC1/16 181JATP	J24185181		1	
R 9917	CHIP RES.	180	1/16W	5%	RMC1/16 181JATP	J24185181		1	
R 9918	CHIP RES.	180	1/16W	5%	RMC1/16 181JATP	J24185181		1	
R 9919	CHIP RES.	180	1/16W	5%	RMC1/16 181JATP	J24185181		1	
R 9920	CHIP RES.	180	1/16W	5%	RMC1/16 181JATP	J24185181		1	
R 9921	CHIP RES.	180	1/16W	5%	RMC1/16 181JATP	J24185181		1	
R 9922	CHIP RES.	180	1/16W	5%	RMC1/16 181JATP	J24185181		1	
R 9923	CHIP RES.	180	1/16W	5%	RMC1/16 181JATP	J24185181		1	
R 9924	CHIP RES.	390	1/16W	5%	RMC1/16 391JATP	J24185391		1	
R 9925	CHIP RES.	390	1/16W	5%	RMC1/16 391JATP	J24185391		1	
S 9901	TACT SWITCH				SKQHFC	N5090073		1	
	SHEET					R8151580		1	

INVERTER Unit

Parts Layout

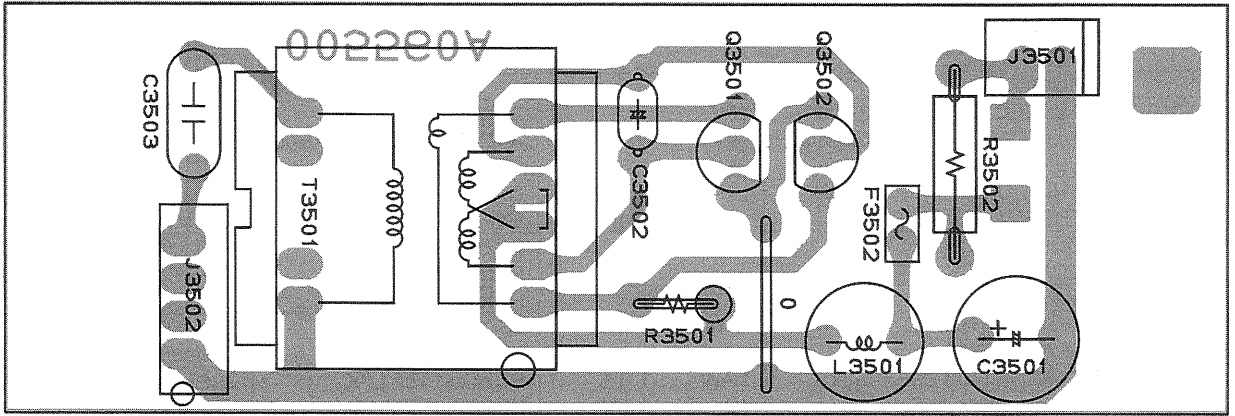
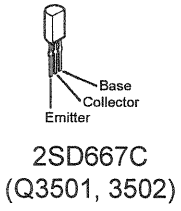

Side A

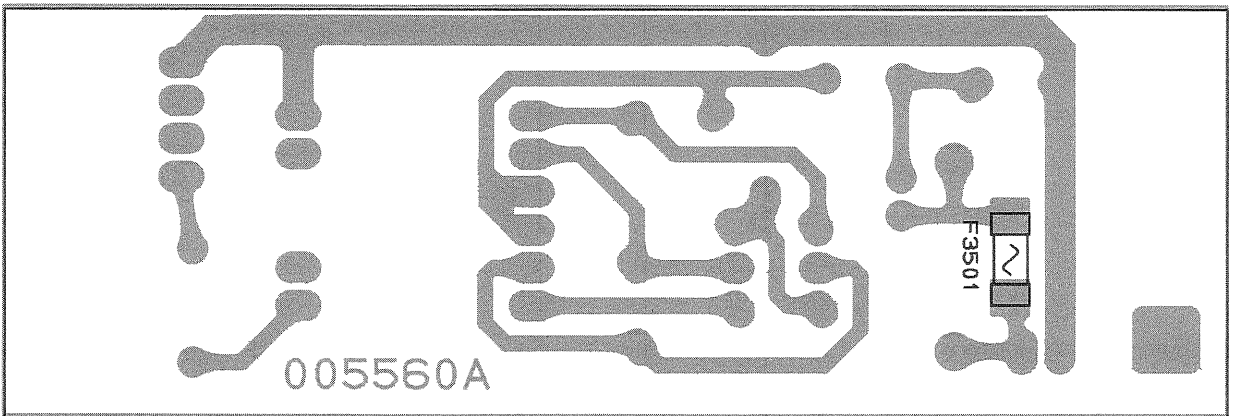

Side B

Circuit Diagram

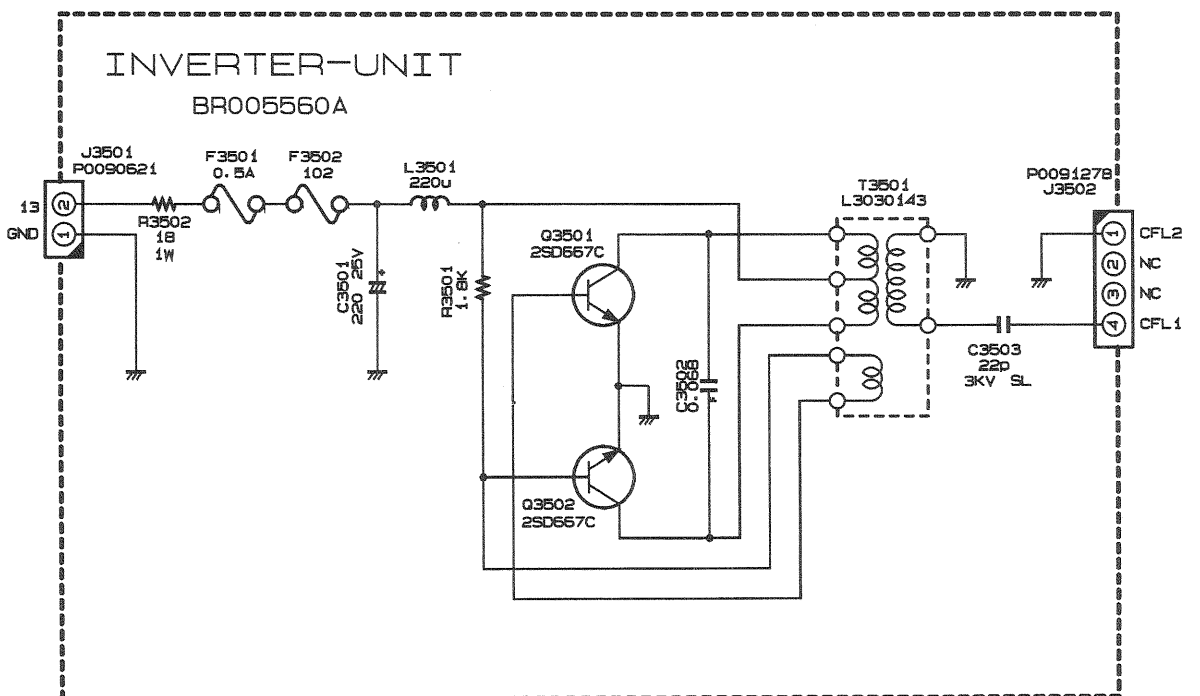

INVERTER Unit

Parts List

REF.	DESCRIPTION	VALUE	V/W	TOL.	MFR'S DESIG	YAESU P/N	VERS.	LOT.	LAY ADR
P.C.B. with Components						CB1185001			
Printed Circuit Board						FR005560A		1	
C 3501	AL.ELECTRO.CAP.	220uF	25V		25V221M8X11TR5	K46140006		1	
C 3502	FILM CAP.	0.068uF	50V		AMZV0050K68300000200	K56170039		1	
C 3503	CERAMIC CAP.	22pF	3KV	SL	DE0507SL220J3K	K00359006		1	
F 3501	CHIP FUSE	0.5A			451.5	Q0000047		1	
F 3502	THERMAL FUSE				EYP2BH102	Q0000065		1	
J 3501	CONNECTOR				SC25-02WS	P0090621		1	
J 3502	CONNECTOR				PI25C04M	P0091278		1	
L 3501	M.RFC	220uH			RCH-895 221K	L1190402		1	
Q 3501	TRANSISTOR				2SD667C TZ	G3406674C		1	A
Q 3502	TRANSISTOR				2SD667C TZ	G3406674C		1	A
R 3501	CARBON FILM RES.	1.8k	1/4W	5%	RD25UJ182T 1.8K	J06245182		1	
R 3502	METAL FILM RES.	18	1W	5%	ERG-1SJ180P 18	J22309009		1	
T 3501	INV TRANS.				EP208B 3318-087	L3030143		1	
Z 3501	SHIELD CASE					R0152080		1	

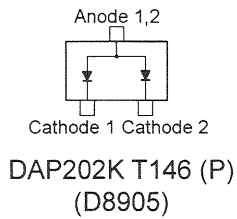
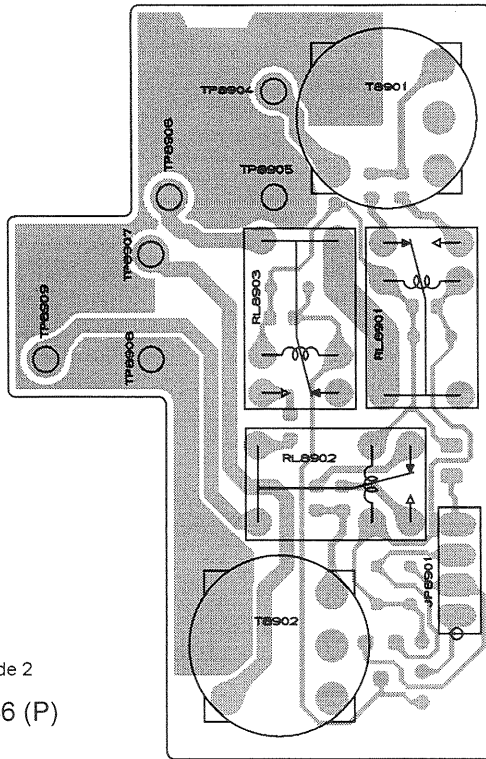

Side A

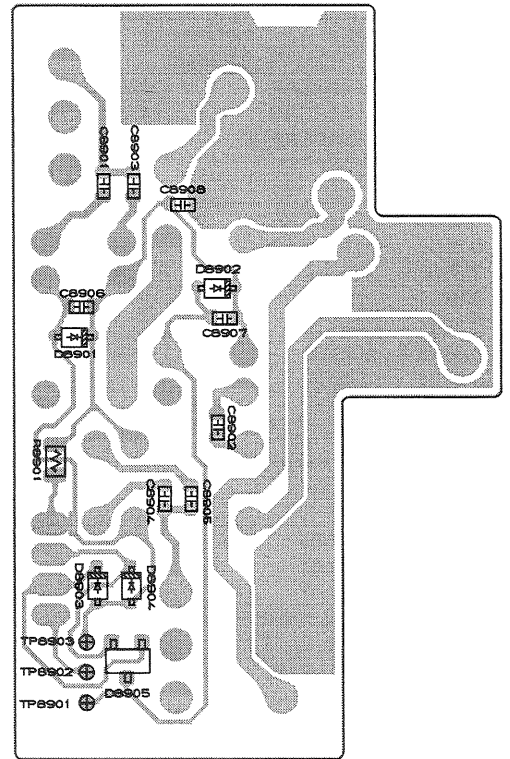

Side B

Parts Diagram

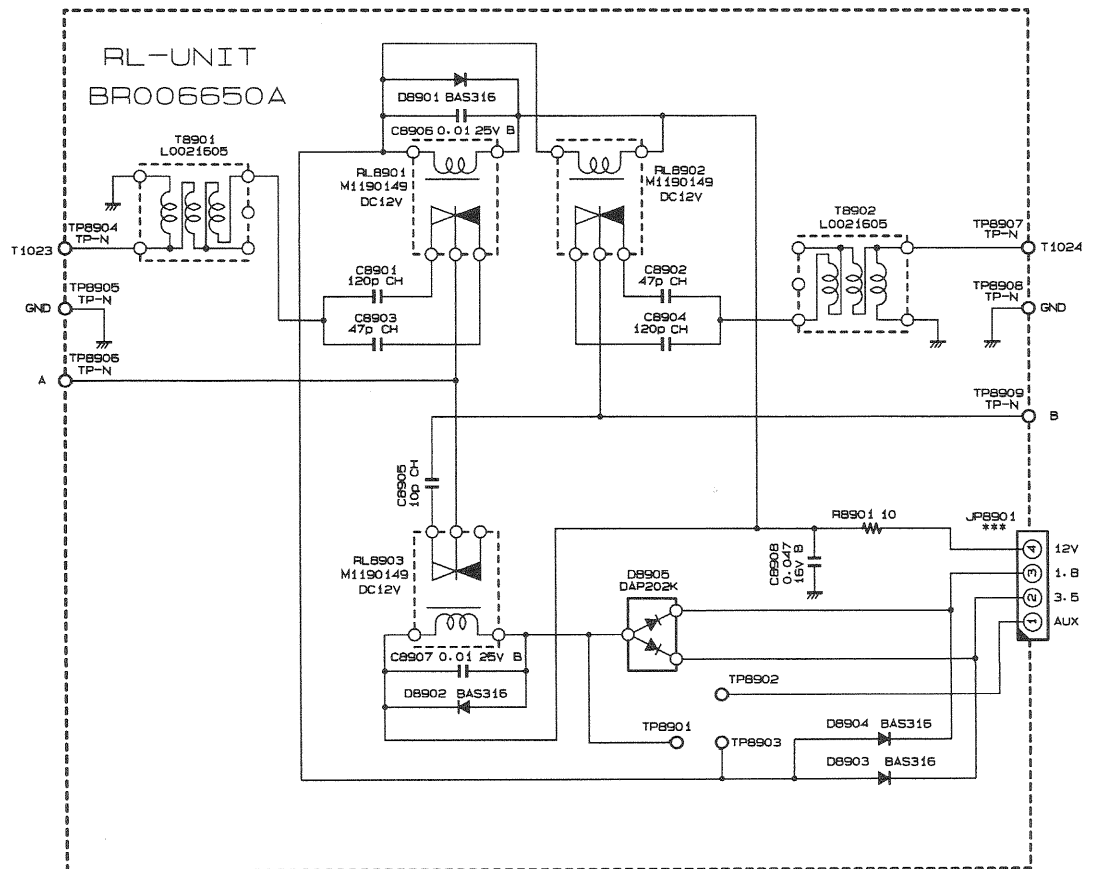

RL Unit (Lot. 1~8)

Parts List

REF.	DESCRIPTION	VALUE	V/W	TOL.	MFR'S DESIG	YAESU P/N	VERS.	LOT.	LAY ADR	
PCB with Compornents						CB1481001				
Printed Circuit Board						FR006650A			-8	
C 8901	CHIPCAP.	120pF	50V	CH	GRM39CH121J50PT	K22174237		-8		
C 8902	CHIPCAP.	47pF	50V	CH	GRM39CH470J50PT	K22174227		-8		
C 8903	CHIPCAP.	47pF	50V	CH	GRM39CH470J50PT	K22174227		-8		
C 8904	CHIPCAP.	120pF	50V	CH	GRM39CH121J50PT	K22174237		-8		
C 8905	CHIPCAP.	10pF	50V	CH	GRM39CH100D50PT	K22174211		-8		
C 8906	CHIPCAP.	0.01uF	25V	B	GRM39B103K25PT	K22144803		-8		
C 8907	CHIPCAP.	0.01uF	25V	B	GRM39B103K25PT	K22144803		-8		
C 8908	CHIPCAP.	0.047uF	16V	B	GRM39B473K16PT	K22124804		-8		
D 8901	DIODE				BAS316	G2070716		-8		
D 8902	DIODE				BAS316	G2070716		-8		
D 8903	DIODE				BAS316	G2070716		-8		
D 8904	DIODE				BAS316	G2070716		-8		
D 8905	DIODE				DAP202K T146	G2070180		-8		
JP8902	WIREASSY				GRN 80 2/2	T50508000		-8		
JP8903	WIREASSY				GRN 80 2/2	T50508000		-8		
JP8904	WIREASSY				GRN 80 2/2	T50508000		-8		
R 8901	CHIPRES.	10	1/10W	5%	RMC1/10T 100J	J24205100		-8		
RL8901	RELAY		DC12V		AHY123 DC12V	M1190149		-8		
RL8902	RELAY		DC12V		AHY123 DC12V	M1190149		-8		
RL8903	RELAY		DC12V		AHY123 DC12V	M1190149		-8		
T 8901	COIL 10WIDE				9-1 2001F	L0021605		-8		
T 8902	COIL 10WIDE				9-1 2001F	L0021605		-8		
TP8904	TERMINAL				TP-NIPS-1091	Q5000082		-8		
TP8905	TERMINAL				TP-NIPS-1091	Q5000082		-8		
TP8906	TERMINAL				TP-NIPS-1091	Q5000082		-8		
TP8907	TERMINAL				TP-NIPS-1091	Q5000082		-8		
TP8908	TERMINAL				TP-NIPS-1091	Q5000082		-8		
TP8909	TERMINAL				TP-NIPS-1091	Q5000082		-8		
	DOUBLE FACE					RA0264000		-8		

SSB-FILTER Unit (Option)

Parts Layout

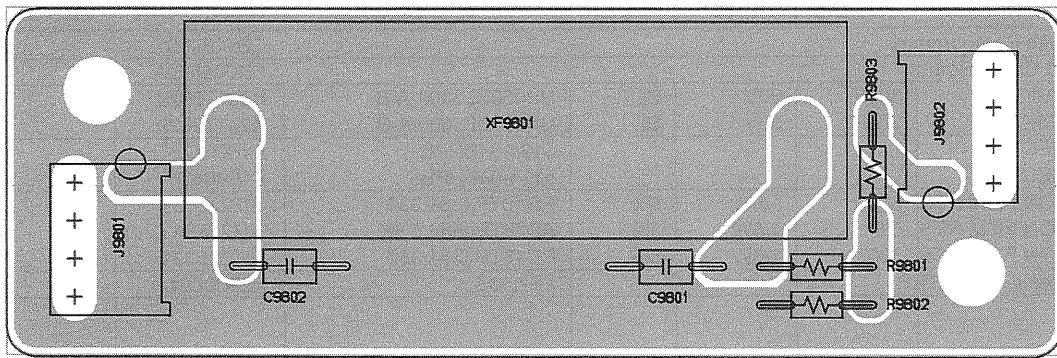

Side A

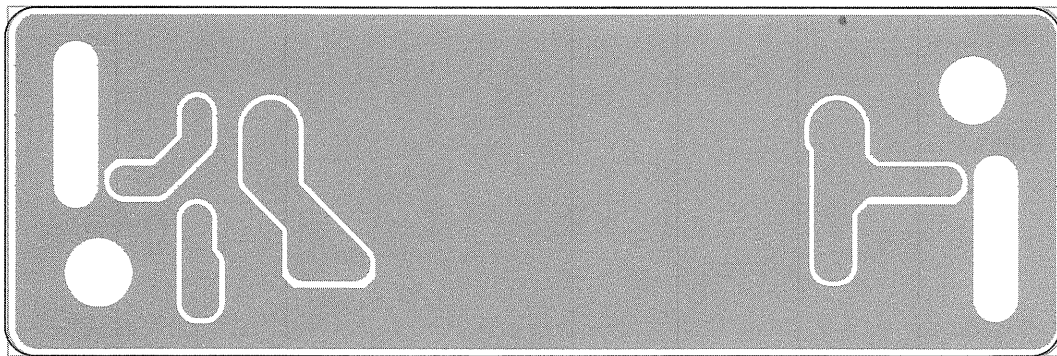

Side B

Parts Diagram

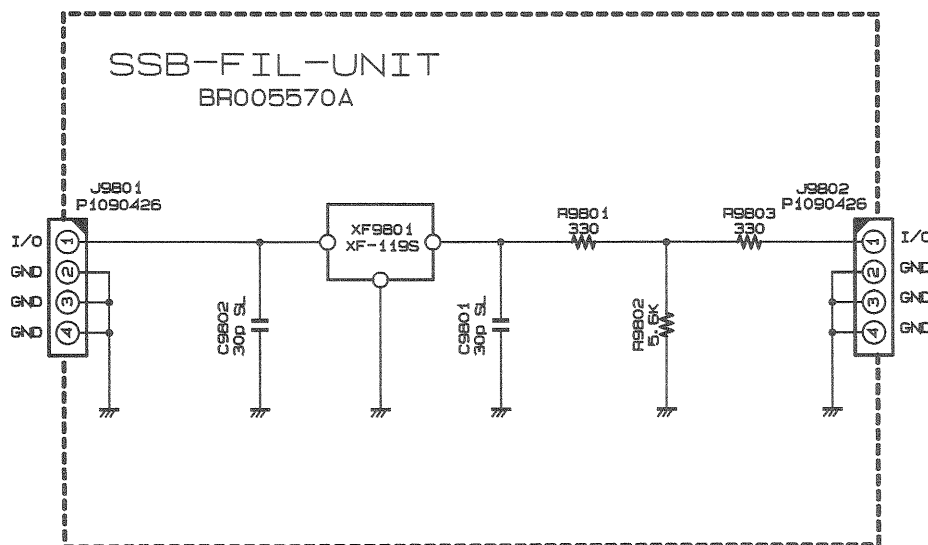

FP-29 Exploded View & Miscellaneous Parts

REF.	YAESU P/N	Description	QTY.
1	U31206002	OVAL HEAD SCREW M2.6X6NI	2
2	U31206007	OVAL HEAD SCREW M2.6X6B	8
3	U03308002	SEMS SCREW ASM3X8NI	4
4	U30312001	FLAT HEAD SCREW M3X12	3
5	U02308001	SEMS SCREW S M3X8	1
6	U02310001	SEMS SCREW S M3X10	2
7	U02306001	SEMS SCREW S M3X6	5
8	U20106007	BINDING HEAD SCREW M2X6B	4
9	U24306007	TAPTITE SCREW M3X6B	4
10	U04335007	SEMS SCREW HSM3X35B	4
11	U66300001	FLANGE NUT N3	4

Basic Accessories		
YAESU P/N	Description	QTY.
T9022299	DC CABLE 06P-06P 2000MM	1
T9017882	AC CABLE 117V3WP YFC-18K	1
Q0000007	FUSE MF60NR250V 10A	1

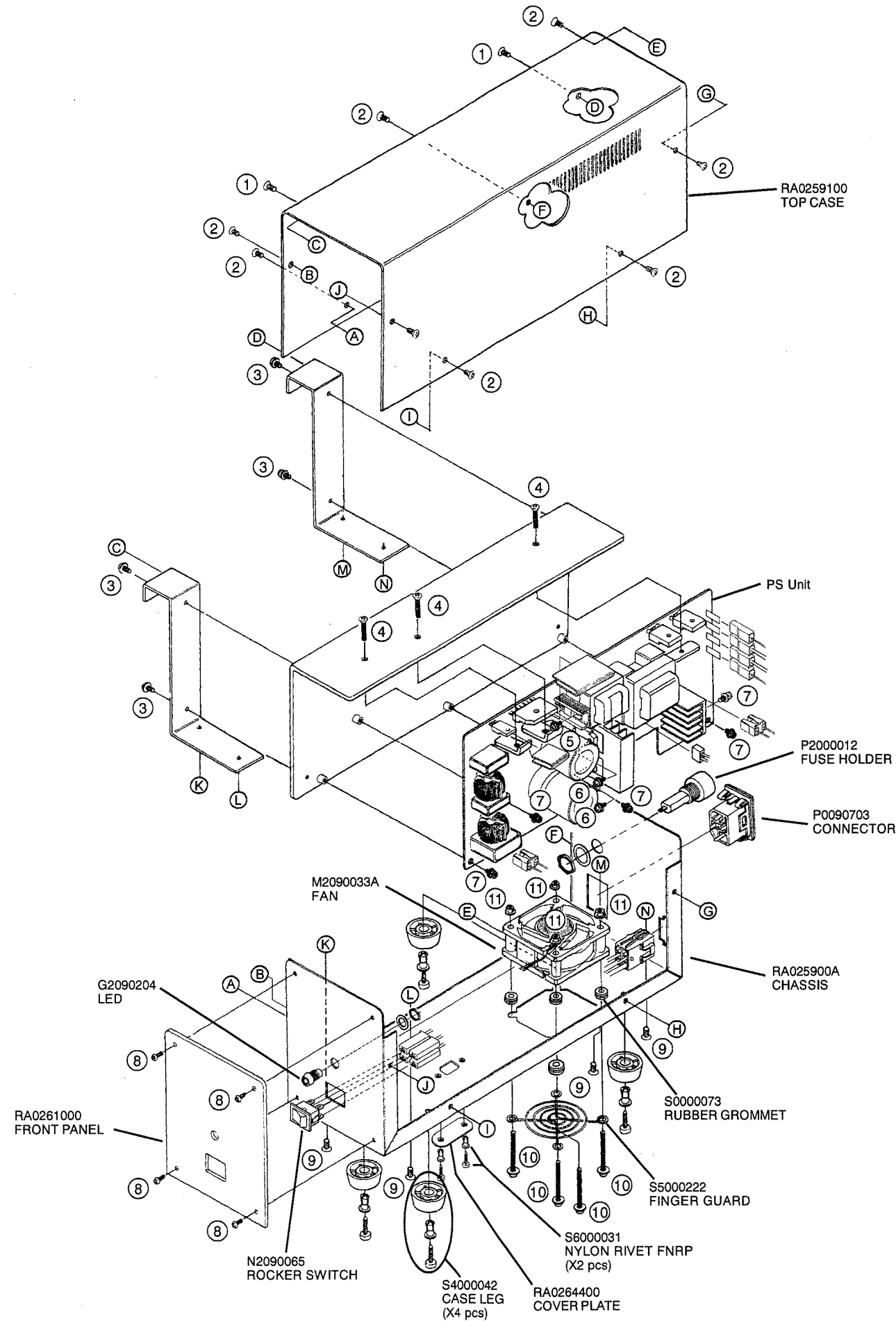

Non-designated parts are available only as part of a designated assembly.

FP-29 Exploded View & Miscellaneous Parts

REF.	DESCRIPTION	VALUE	V/W	TOL.	MFR'S DESIG	YAESU P/N	VERS.	LOT.	SIDE	LAY ADR
C 0001	CERAMIC CAP.	0.01uF	2.6KV	F	ECKATS103MF	K13359001				
C 0002	CERAMIC CAP.	0.01uF	2.6KV	F	ECKATS103MF	K13359001				
F 0001	FUSE		10A		MF60NR250V	Q0000007				
JP0001	WIRE ASSY				WHT 120 <10>/<10>	T55912041				
P 0001	WIRE ASSY					T9206904				
P 0003	WIRE ASSY					T9206906				
P 0006	WIRE ASSY					T9206903				
P 0007	WIRE ASSY					T9206903				
P 0010	WIRE ASSY					T9206905				
P 0011	WIRE ASSY					T9206907				
P 0012	WIRE ASSY					T9206908				
R 0001	CARBON FILM RES.	3.9K	1/4W	5%	RD14TJ392	J01245392				

FP-29 PCB Diagrams & Parts Lists

Circuit Diagram

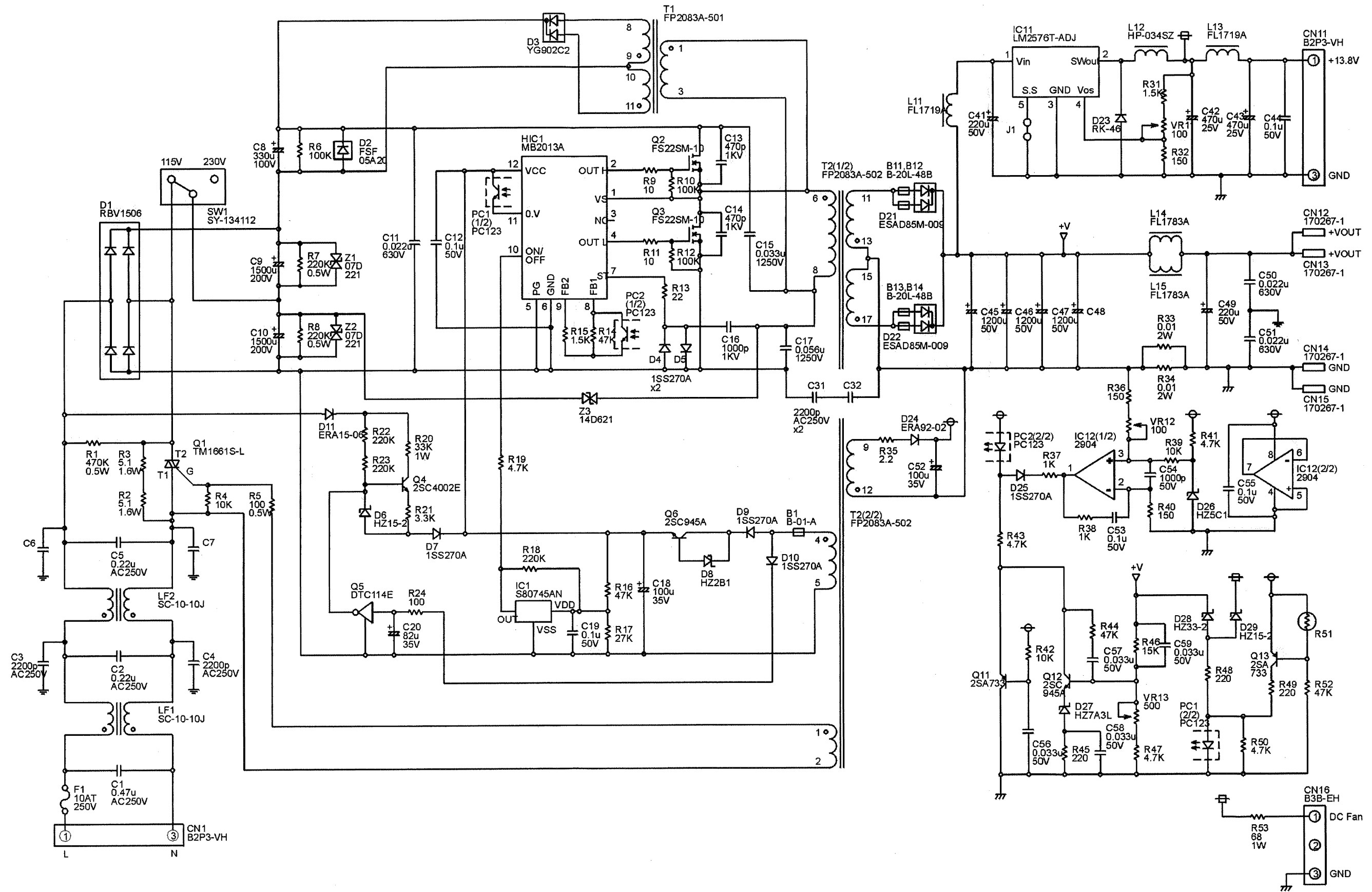

FP-29 PCB Diagrams & Parts Lists

Parts Layout

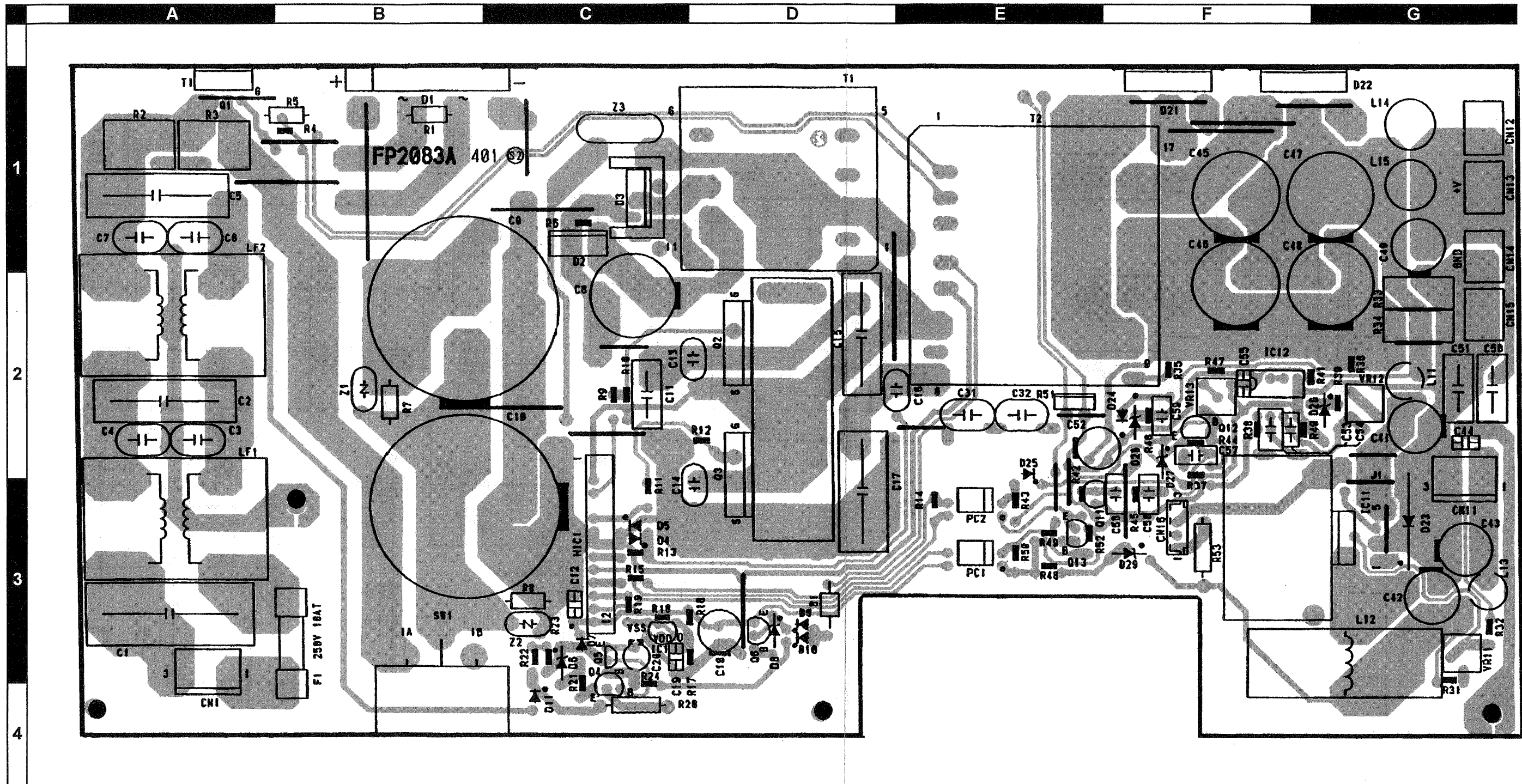

FP-29 PCB Diagrams & Parts Lists

Parts List

REF.	DESCRIPTION	VALUE	V/W	TOL.	MFR'S DESIG	YAESU P/N	VERS.	LOT.	LAY ADR
PCB with component					FP2083A	Q7000385		1-	
B 1	BEADS INDUCTOR				B-01-A	L1190386		1-	
B 11	FERRITE BEADS				B-20L-48B	L9190120		1-	
B 12	FERRITE BEADS				B-20L-48B	L9190120		1-	
B 13	FERRITE BEADS				B-20L-48B	L9190120		1-	
B 14	FERRITE BEADS				B-20L-48B	L9190120		1-	
C 1	FILM CAP.	0.47uF	250V		ECQU2A-474MV	K52240010		1-	
C 2	FILM CAP.	0.22uF	250V		ECQU2A-224MV	K52240009		1-	
C 3	CERAMIC CAP.	2200pF	250V		DE1007E222M-KH	K10249002		1-	
C 4	CERAMIC CAP.	2200pF	250V		DE1007E222M-KH	K10249002		1-	
C 5	FILM CAP.	0.22uF	250V		ECQU2A-224MV	K52240009		1-	
C 8	AL. ELECTRO. CAP.	330uF	100V		LXV100VB330ML30	K40209001		1-	
C 9	AL. ELECTRO. CAP.	1500uF	200V		EC0S2DB152EB	K40239007		1-	
C 10	AL. ELECTRO. CAP.	1500uF	200V		EC0S2DB152EB	K40239007		1-	
C 11	FILM CAP.	0.022uF	630V		MMC630K223-0100	S8100928		1-	
C 12	CERAMIC CAP.	0.1uF	50V		RPE132F104Z50	K23170054		1-	
C 13	CERAMIC CAP.	470pF	1kV		DE0705R471K1K	K10309002		1-	
C 14	CERAMIC CAP.	470pF	1kV		DE0705R471K1K	K10309002		1-	
C 15	FILM CAP.	0.033uF	1250V		ECWH12333JV	K55310001		1-	
C 16	CERAMIC CAP.	1000pF	1kV		DE0705R102K1K	K10309003		1-	
C 17	FILM CAP.	0.56uF	1250V		ECWH12563JV	K55310002		1-	
C 18	AL. ELECTRO. CAP.	100uF	35V		EEUFC1H101	K40169040		1-	
C 19	CERAMIC CAP.	0.1uF	50V		RPE132F104Z50	K23170054		1-	
C 20	AL. ELECTRO. CAP.	82uF	35V		EEUFC1V820-E	K40169041		1-	
C 31	CERAMIC CAP.	2200pF	250V		DE1007E222M-KH	K10249002		1-	
C 32	CERAMIC CAP.	2200pF	250V		DE1007E222M-KH	K10249002		1-	
C 41	AL. ELECTRO. CAP.	220uF	50V		EEUFC1H221	K40179077		1-	
C 42	AL. ELECTRO. CAP.	470uF	25V		EEUFC1E471	K40149067		1-	
C 43	AL. ELECTRO. CAP.	470uF	25V		EEUFC1E471	K40149067		1-	
C 44	CERAMIC CAP.	0.1uF	50V		RPE132F104Z50	K23170054		1-	
C 45	CERAMIC CAP.	0.1uF	50V		RPE132F104Z50	K23170054		1-	
C 45	AL. ELECTRO. CAP.	1200uF	50V		EEUFC1H122	K40179078		1-	
C 46	AL. ELECTRO. CAP.	1200uF	50V		EEUFC1H122	K40179078		1-	
C 47	AL. ELECTRO. CAP.	1200uF	50V		EEUFC1H122	K40179078		1-	
C 49	AL. ELECTRO. CAP.	220uF	50V		EEUFC1H221	K40179077		1-	
C 50	FILM CAP.	0.022uF	630V		MMC630K223-0100	S8100928		1-	
C 51	FILM CAP.	0.022uF	630V		MMC630K223-0100	S8100928		1-	
C 52	AL. ELECTRO. CAP.	100uF	35V		EEUFC1H101	K40169040		1-	
C 53	FILM CAP.	0.1uF	50V		ECQB1H104KFW	K50170107		1-	
C 54	FILM CAP.	1000pF	50V		ECQB1H102KFW	K50170106		1-	
C 56	FILM CAP.	0.033uF	50V		ECQB1H333KFW	K50170108		1-	
C 57	FILM CAP.	0.033uF	50V		ECQB1H333KFW	K50170108		1-	
C 58	FILM CAP.	0.033uF	50V		ECQB1H333KFW	K50170108		1-	
C 59	FILM CAP.	0.033uF	50V		ECQB1H333KFW	K50170108		1-	
CN 1	CONNECTOR				B2P3-VH	P0090866		1-	
CN 11	CONNECTOR				B2P3-VH	P0090866		1-	
CN 12	CONNECTOR				B170267-1	Q5000164		1-	
CN 13	CONNECTOR				B170267-1	Q5000164		1-	
CN 14	CONNECTOR				B170267-1	Q5000164		1-	
CN 15	CONNECTOR				B170267-1	Q5000164		1-	
CN 16	CONNECTOR				B3B-EH	P0090667		1-	
D 1	DIODE				RBV1506	G2090774		1-	B1
D 2	DIODE				FSF05A20	G2090771		1-	C1
D 3	DIODE				YG902C2	G2090775		1-	C1
D 4	DIODE				1SS270A	G2090754		1-	C3
D 5	DIODE				1SS270A	G2090754		1-	C3
D 6	DIODE				HZ15-2	G2090406		1-	C3
D 7	DIODE				1SS270A	G2090754		1-	C3
D 8	DIODE				HZ2B1	G2090755		1-	D3
D 9	DIODE				1SS270A	G2090754		1-	D3
D 10	DIODE				1SS270A	G2090754		1-	D3
D 11	DIODE				ERA15-06	G2090769		1-	C4
D 21	DIODE				ESAD85-009	G2090732		1-	F1
D 22	DIODE				ESAD85-009	G2090732		1-	F2
D 23	DIODE				RK46	G2090776		1-	G3
D 24	DIODE				ERA92-02	G2090770		1-	F2
D 25	DIODE				1SS270A	G2090754		1-	E2
D 26	DIODE				HZ5C1	G2090188		1-	F2

FP-29 PCB Diagrams & Parts Lists

Parts List

REF.	DESCRIPTION	VALUE	V/W	TOL.	MFR'S DESIG	YAESU P/N	VERS.	LOT.	LAYADR
D 27	DIODE				HZ5C1	G2090773		1-	F2
D 28	DIODE				HZ33-2	G2090772		1-	G2
D 29	DIODE				HZ15-2	G2090406		1-	F3
F 1	FUSE				215 010 5HT10	Q0000099		1-	
HIC1	MODULE				MB2013A	S8100824		1-	
IC 1	IC				S-80745AN-D9-T1	G1092610		1-	C3
IC 11	IC				LM2576T-ADJ	G1092803		1-	G3
IC 12	IC				NJM2904D	G1090539		1-	F2
L 11	RFC				FL1719A	S8100204		1-	
L 12	RFC				HP-034SZ	S8100925		1-	
L 13	RFC				FL1719A	S8100204		1-	
L 14	RFC				FL1783A	S8100206		1-	
L 15	RFC				FL1783A	S8100206		1-	
LF 1	LINE FILTER				SC-10-10J	S8100923		1-	
LF 2	LINE FILTER				SC-10-10J	S8100923		1-	
PC 1	PHOTO COUPLER				PC123FY2	G0090036		1-	
PC 2	PHOTO COUPLER				PC123FY2	G0090036		1-	
Q 1	TRAIACK				TM1661S-L	G3090138		1-	A1
Q 2	POWER MOS FET				FS222M-10	G3090137		1-	D2
Q 3	POWER MOS FET				FS222M-10	G3090137		1-	D2
Q 4	TRANSISTOR				2SC4002E	G3340020E		1-	C4
Q 5	TRANSISTOR				DTC114ESA	G3090130		1-	C3
Q 6	TRANSISTOR				2SC945AP	G3309451P		1-	D3
Q 11	TRANSISTOR				2SA733	G3107330K		1-	E3
Q 12	TRANSISTOR				2SC945AP	G3309451P		1-	F2
Q 13	TRANSISTOR				2SA733	G3107330K		1-	E3
R 1	CARBON FILM RES.	470k	1/2W		D50SS-470K OHM J	S8100947		1-	
R 2	FUSE RES.	5.1	5W		A53K-5R1J ERU5TAJ5R1	S8100920		1-	
R 3	FUSE RES.	5.1	5W		A53K-5R1J ERU5TAJ5R1	S8100920		1-	
R 4	CARBON FILM RES.	10k	1/4W		RD16S-10K OHM J	S8100933		1-	
R 5	CARBON FILM RES.	100	1/2W		RD50SS-100 OHM J	S8100946		1-	
R 6	CARBON FILM RES.	100k	1/4W		RD16S-100K OHM J	S8100932		1-	
R 7	CARBON FILM RES.	220k	1/2W		RD50S-220K OHM J	S8100945		1-	
R 8	CARBON FILM RES.	220k	1/2W		RD50S-220K OHM J	S8100945		1-	
R 9	CARBON FILM RES.	10	1/4W		RD16S-10 OHM J	S8100930		1-	
R 10	CARBON FILM RES.	100k	1/4W		RD16S-100K OHM J	S8100932		1-	
R 11	CARBON FILM RES.	10	1/4W		RD16S-10 OHM J	S8100930		1-	
R 12	CARBON FILM RES.	100k	1/4W		RD16S-100K OHM J	S8100932		1-	
R 13	CARBON FILM RES.	22	1/4W		RD16S-22 OHM J	S8100938		1-	
R 14	CARBON FILM RES.	47k	1/4W		RD16S-47K OHM J	S8100944		1-	
R 15	CARBON FILM RES.	1.5k	1/4W		RD16S-1.5K OHM J	S8100929		1-	
R 16	CARBON FILM RES.	47k	1/4W		RD16S-47K OHM J	S8100944		1-	
R 17	CARBON FILM RES.	27k	1/4W		RD16S-27K OHM J	S8100941		1-	
R 18	CARBON FILM RES.	220	1/4W		RD16S-220K OHM J	S8100940		1-	
R 19	CARBON FILM RES.	4.7k	1/4W		RD16S-4.7K OHM J	S8100943		1-	
R 20	METAL FILM RES.	33k	1W		ERG1SJ-333	J22305333		1-	
R 21	CARBON FILM RES.	3.3k	1/4W		RD16S-3.3K OHM J	S8100942		1-	
R 22	CARBON FILM RES.	220	1/4W		RD16S-220K OHM J	S8100940		1-	
R 23	CARBON FILM RES.	220k	1/4W		RD16S-220K OHM J	S8100940		1-	
R 24	CARBON FILM RES.	100	1/4W		RD16S-100 OHM J	S8100931		1-	
R 31	CARBON FILM RES.	1.5k	1/4W		RD16S-1.5K OHM J	S8100929		1-	
R 32	CARBON FILM RES.	150	1/4W		RD16S-150 OHM J	S8100934		1-	
R 33	RES.	0.01	2W		2W 0.01OHM	J31339001		1-	
R 34	RES.	0.01	2W		2W 0.01OHM	J31339001		1-	
R 35	CARBON FILM RES.	2.2	1/4W		RD16S-2.2 OHM J	S8100937		1-	
R 36	CARBON FILM RES.	150	1/4W		RD16S-150 OHM J	S8100934		1-	
R 37	CARBON FILM RES.	1k	1/4W		RD16S-1K OHM J	S8100936		1-	
R 38	CARBON FILM RES.	1k	1/4W		RD16S-1K OHM J	S8100936		1-	
R 39	CARBON FILM RES.	10k	1/4W		RD16S-10K OHM J	S8100933		1-	
R 40	CARBON FILM RES.	150	1/4W		RD16S-150 OHM J	S8100934		1-	
R 41	CARBON FILM RES.	4.7k	1/4W		RD16S-4.7K OHM J	S8100943		1-	
R 42	CARBON FILM RES.	10k	1/4W		RD16S-10K OHM J	S8100933		1-	
R 43	CARBON FILM RES.	4.7k	1/4W		RD16S-4.7K OHM J	S8100943		1-	
R 44	CARBON FILM RES.	47k	1/4W		RD16S-47K OHM J	S8100944		1-	
R 45	CARBON FILM RES.	220	1/4W		RD16S-220 OHM J	S8100939		1-	
R 46	CARBON FILM RES.	15k	1/4W		RD16S-15K OHM J	S8100935		1-	
R 47	CARBON FILM RES.	4.7k	1/4W		RD16S-4.7K OHM J	S8100943		1-	
R 48	CARBON FILM RES.	220	1/4W		RD16S-220 OHM J	S8100939		1-	

FP-29 PCB Diagrams & Parts Lists

Parts List

REF.	DESCRIPTION	VALUE	V/W	TOL.	MFR'S DESIG	YAESU P/N	VERS.	LOT.	LAY ADR
R 49	CARBON FILM RES.	220	1/4W		RD16S-220 OHM J	S8100939		1-	
R 50	CARBON FILM RES.	4.7k	1/4W		RD16S-4.7K OHM J	S8100943		1-	
R 51	POSISTOR				PTH9M04BD222TS2F333	G9090083		1-	
R 52	CARBON FILM RES..	47k	1/4W		RD16S-47K OHM J	S8100944		1-	
R 53	METAL FILM RES.	680	1W		ERG1SJ-680	J22305680		1-	
SW 1	VOLTAGE SELECTOR				SY-134C12	S8100924		1-	
T 1	CONVERTER TRANSE				FP2083A-501	S8100921		1-	
T 2	CONVERTER TRANSE				FP2083A-502	S8100922		1-	
VR 11	TRIMER				FT-6P-100	S8100926		1-	
VR 12	TRIMER				FT-6P-100	S8100926		1-	
VR 13	TRIMER				FT-6P-500	S8100927		1-	
Z 1	SURGE ABSORBER				ERZ-V07D221	Q9000599		1-	
Z 2	SURGE ABSORBER				ERZ-V07D221	Q9000599		1-	
Z 3	SURGE ABSORBER				ERZ-V14D621	Q9000762		1-	
	FUSE CLIP				F220P	P2000064		1-	
	FITTING				FR309A	S8000030		1-	
	FITTING				FR336A	S8001784		1-	
	FITTING				FR315A	S8001892		1-	
	FITTING				FR333-3019	S8001893		1-	
	HEAT SHINK				20PB31/20PC31	S8001888		1-	
	HEAT SHINK				FP2083A-601	S8001890		1-	
	HEAT SHINK				FP2083A-602	S8001891		1-	
	THERMAL CONDUCTOR				FB428A	S8001889		1-	
	THERMAL CONDUCTOR				FB419	S8001781		1-	
	THERMAL CONDUCTOR				TC-30A(T0-3P)	S8001894		1-	
	THERMAL CONDUCTOR				TC-30A(T0-3P)	S8001894		1-	

FP-29 PCB Diagrams & Parts Lists

Notes



Copyright © 2001
VERTEX STANDARD CO., LTD.
All right reserved.
Printed in japan

No portion of this manual
may be reproduced
without the permission of
VERTEX STANDARD CO., LTD.

0103v-AY

