

**INSTRUCTION
MANUAL
FT-221 R**

YAESU MUSEN CO., LTD.

TOKYO JAPAN

TABLE OF CONTENTS

| | (Page) |
|---------------------------------|--------|
| GENERAL DESCRIPTION | 1 |
| SPECIFICATION | 2 |
| INSTALLATION | 4 |
| CONTROLS AND SWITCHES | 6 |
| REAR PANEL CONNECTIONS | 8 |
| OPERATION | 9 |
| BLOCK DIAGRAM | 13 |
| CIRCUIT DESCRIPTION | 14 |
| ALIGNMENT AND MAINTENANCE | 25 |
| RESISTANCE VOLTAGE CHART | 32 |
| PARTS LIST | 38 |

This manual is revised for the units produced starting with Lot No. 009 and the lots produced subsequently.

Copyright of
Yaesu Musen Co. Ltd.

FT-221R VHF TRANSCEIVER



GENERAL DESCRIPTION

The model FT-221R two meter transceiver is a precision built, compact, high performance transceiver of advanced design, providing all mode operation: SSB (LSB or USB selectable), AM, CW and FM with repeater offset capability. Advanced PLL (Phase-Lock Loop) circuitry offers unsurpassed stability and clean, spurious free signals. The transceiver operates at an input of 20 watts on 144 through 148 MHz, in eight 500 kHz segments permitting 1 kHz accurate dial readout. All circuits are fully transistorized and computer type plug-in modules are used for increased reliability and service ability.

Adoption of pre-set passband tuning and wide band amplifier techniques, provide the optimum selectivity and performance needed on today's active 2 meter band.

The transceiver is self contained, requiring only an antenna and power source for home, portable or mobile operation. The transceiver may be operated from 100/110/117/200/220 or 234 volt AC when the power transformer is appropriately wired. The FT-221 is normally supplied for 117 volt AC and 12 volt DC operation. Two power cords are

supplied with the transceiver. Selection of AC or DC operation is automatically made when the proper line cord plug is inserted into the receptacle on the rear panel.

Deluxe features such as VOX, break-in CW with side tone, 100 kHz calibrator, noise blanker and squelch are built-in. In addition to continuous VFO coverage, 88 crystal-controlled channels (11 channels x 8 bands = 88 channels), clarifier and speaker are all integral parts of the unit. For "tone burst" actuated repeater operation, an adjustable "tone burst" generator with automatic tone actuation circuit (patent pending) is included.

The entire transceiver weighs approximately 8.5 kg, and is 280 m/m wide, 125 m/m high, and 295 m/m deep. Construction of heavy-gage steel provides an extremely rugged package, virtually immune to the effects of vibration and shock encountered in rugged mobile service.

SPECIFICATIONS

GENERAL

Frequency Range:

144.0 ~ 144.5 MHz
144.5 ~ 145.0 MHz
145.0 ~ 145.5 MHz
145.5 ~ 146.0 MHz
146.0 ~ 146.5 MHz
146.5 ~ 147.0 MHz
147.0 ~ 147.5 MHz
147.5 ~ 148.0 MHz

Frequency Readout:

Better than 1 kHz

Emission:

SSB (LSB or USB selectable), AM, FM and CW.

Power Output:

SSB 12 Watts PEP
FM, CW 14 Watts
AM 2.5 Watts

Frequency Stability:

Within 100 Hz during any 30 minute period after warm up. Not more than 20 Hz with a 10% line voltage variation.

Antenna Impedance:

50 ohms unbalanced

Repeater Burst Signal:

1500 to 2000 Hz adjustable

Repeater Split

600 kHz and any frequency up to 1 MHz

Power Requirement:

AC 100/110/117/200/220/234 volts
50/60 Hz
DC +12 ~ 14.5 Volts, negative ground

Power Consumption:

AC Receive 30VA
Transmit 90VA at 10 watts output
DC Receive 0.6A
Transmit 3A at 10 watts output

Size:

280 (W) x 125 (H) x 295 (D) m/m

Weight:

Approx. 8.5 kg

RECEIVER

Sensitivity:

SSB/CW 0.5 μ V for 10 dB S/N
FM 0.75 μ V for 20 dB QS
AM 1.0 μ V for 10 dB S/N

Selectivity:

SSB/CW/AM 2.4 kHz at 6 dB
4.1 kHz at 60 dB
FM \pm 6 kHz at 6 dB
 \pm 12 kHz at 60 dB

Image Ratio:

Better than - 60 dB

Spurious Response:

Better than 1 μ V at antenna input

Speaker Impedance:

4 ohms

Audio Output:

2 Watts at 10% distortion

TRANSMITTER

Audio Response:

300 ~ 2700 Hz \pm 3 dB

Carrier Suppression:

40 dB or better

Unwanted Sideband Suppression:

40 dB or better at 1 kHz

Spurious Radiation:

Down 60 dB or better

FM Deviation:

Maximum 12 kHz: Factory set at \pm 5 kHz

SEMICONDUCTOR COMPLEMENT

Transistors:

| | | | |
|---------|----|-----------|---|
| 2SD114 | 1 | 2SC735Y | 3 |
| 2SD313D | 3 | 2SC711 | 1 |
| 2SC372Y | 35 | 2SA695 | 1 |
| 2SC784R | 5 | 2SD359 | 1 |
| 2SC373 | 3 | 2SB529 | 1 |
| MPSA13 | 2 | 2SC1000GR | 2 |
| 2SC741 | 1 | 2N5590 | 1 |
| 2SC730 | 1 | 2N5591 | 1 |

Programmable Unijunction Transistor:

| | |
|-------|---|
| N13T1 | 1 |
|-------|---|

Diodes:

| | | | |
|----------|----|---------|----|
| DS-130YD | 1 | WZ-110 | 2 |
| 1S1555 | 57 | 1N4740 | 1 |
| 10D1 | 7 | GD-1 | 1 |
| M4B-5 | 1 | RD-1 | 1 |
| 1S188FM | 13 | TLR-108 | 1 |
| 1S1007 | 12 | 1SV50 | 3 |
| WZ-061 | 2 | 1S2209 | 12 |
| WZ-090 | 1 | | |

FETs:

| | | | |
|---------|----|-------|---|
| 2SK19GR | 15 | 3SK51 | 1 |
| 2SK19Y | 2 | | |

Thyristor:

| | |
|--------|---|
| CW-01B | 1 |
|--------|---|

Integrated Circuits:

| | | | |
|--------------|---|----------|---|
| μ A703HC | 2 | TP4011AN | 5 |
| LD3001 | 2 | 34024PC | 1 |
| TA7061AP | 1 | TA7045M | 1 |
| TP4049AN | 1 | TP4027AN | 1 |

Varistor:

| | |
|-------|---|
| MV-5W | 1 |
|-------|---|

The FT-221R is supplied complete with all cables, connectors, fuses and microphone as shown below.

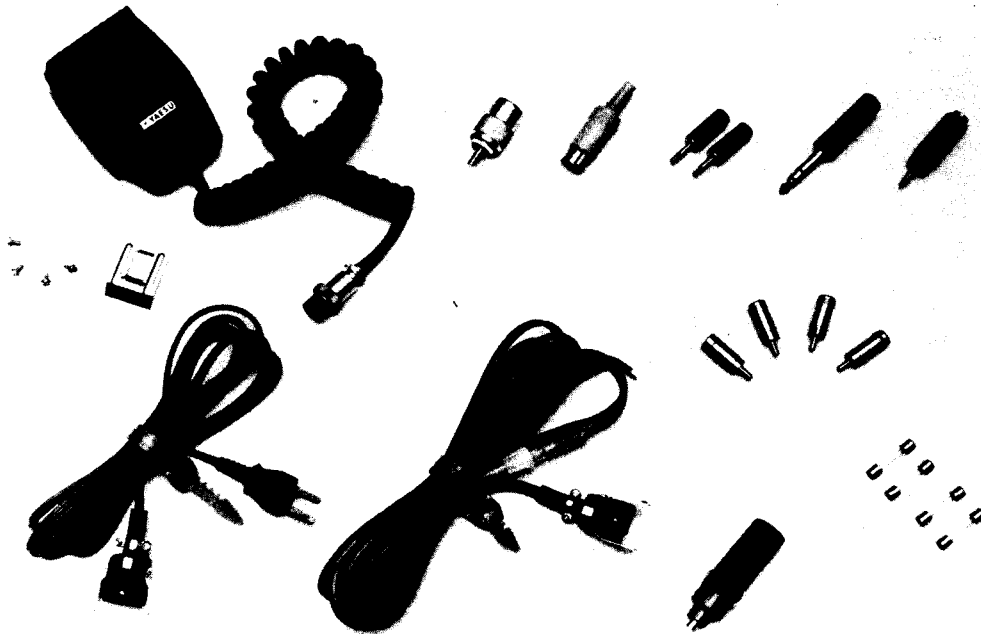

Figure 1

INSTALLATION

GENERAL

The FT-221R transceiver has been designed primarily for base service, requiring only an antenna. However, the transceiver provides for efficient mobile service. The transceiver has been factory pre-tuned and requires no adjustment for normal operation into a matched 50 ohm load.

The antenna and its location are the most important consideration in both base and mobile installations, where effective communication range is directly related to antenna height. The antenna should always be as high and in the clear as possible, and a minimum distance of 5 feet should be maintained between the VHF and other antennas. In a mobile installation, it is advisable to locate the antenna as far from the engine as practical in order to minimize any ignition noise pickup. In all installations, the most popular antenna types are either a 1/4 wave length whip with unity gain or a 5/8 wave length whip with a base matching device affording approximately 3.5 dB gain. Our mobile antenna, RSL-145, is available through your dealer.

To minimize loss in the antenna system, use the shortest length of coaxial cable that is practical, avoiding any sharp angles or kinks. Use type RG-8/U cable if the transmission line length exceeds 25 feet, while RG-58/U may be used for shorter lengths.

BASE STATION INSTALLATION

The transceiver is designed for use in many areas of the world where the supply voltage may differ from the operator's local supply voltage. Therefore, before connecting the AC cord to the power outlet, be sure that the voltage marked on the rear of the transceiver agrees with the local AC supply voltage. If not, please refer to Page 5 for rewiring of the transformer primary connections.

CAUTION

PERMANENT DAMAGE WILL RESULT IF IMPROPER AC SUPPLY VOLTAGE IS APPLIED TO THE TRANSCEIVER. OUR WARRANTY DOES NOT COVER THE DAMAGE CAUSED BY SUCH AN IMPROPER SUPPLY VOLTAGE.

Be sure that a proper fuse is used according to the local supply voltage: 2 amps for 117 volts and 1 amp for 220 volts. The transceiver should be connected to a good ground. The ground lead should be connected to the terminal marked GND located on the rear panel of the transceiver.

It is recommended that excessively warm locations be avoided. The transceiver should be placed in a location that has adequate space to permit free air circulation through the cabinet openings.

MOBILE INSTALLATION

The transceiver will operate satisfactorily from any 12 volt negative ground battery source by connecting the DC power cord to the rear panel receptacle. In the car, a location should be selected that is clear of heater ducts to protect it from excessive heat. No special mounting precautions need to be observed if adequate ventilation space is available. A minimum of two inches air space above the cabinet top and on all sides is recommended to allow proper air flow around the cabinet. You may put it on the seat but be sure that there is clearance between the transceiver bottom and seat. Since the transceiver requires an average of 3 amps on transmit, the fuse in the DC power cable should be rated at 5 amps.

When making connections to the car battery, be certain that the RED lead is connected to the positive (+) terminal and the BLACK lead to the negative (-) terminal of the battery. Reversed connection could permanently damage the transceiver. The BLACK lead should run directly to the negative terminal of the battery. The power cable should be kept away from ignition wires and be as short as possible to minimize voltage drop and to provide a low impedance path from the transceiver to the battery.

Prior to operating the transceiver in a mobile installation, the voltage regulator setting should be checked. In many vehicles, the voltage regulators are very poor and in some cases the regulator may be adjusted for an excessively high charging

voltage. As the battery and regulator age, the maximum voltage while charging can increase to a very high level which is not only detrimental to the battery but could cause damage to the transceiver.

The transceiver is designed to operate from a source voltage range of 11 to 14 volts. It is necessary to carefully set the regulator so that the highest charging voltage does not exceed 14 volts. The transceiver should be switched "OFF" when the vehicle is started in order to prevent voltage transients from damaging the transistors.

It is recommended that the microphone furnished with this transceiver be used, however any other microphone of 500 ~ 600 ohm impedance may be used. Refer to Figure 2 for the microphone plug connections. The microphone bracket may be put on the side of the cabinet. It may also be put at any convenient place by making two 2.5 m/m holes spaced 14 m/m.

A speaker is built into the transceiver, however the audio output is also available for an external speaker use. Any speaker having a 4 ohm impedance may be used and when the external speaker plug is plugged into the EXT SP jack on the rear panel, the built-in speaker is disabled.

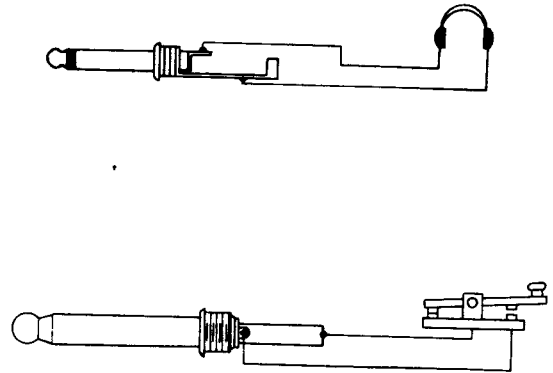
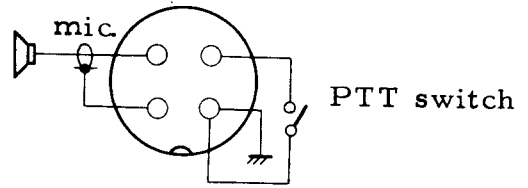

Figure 2: Connection

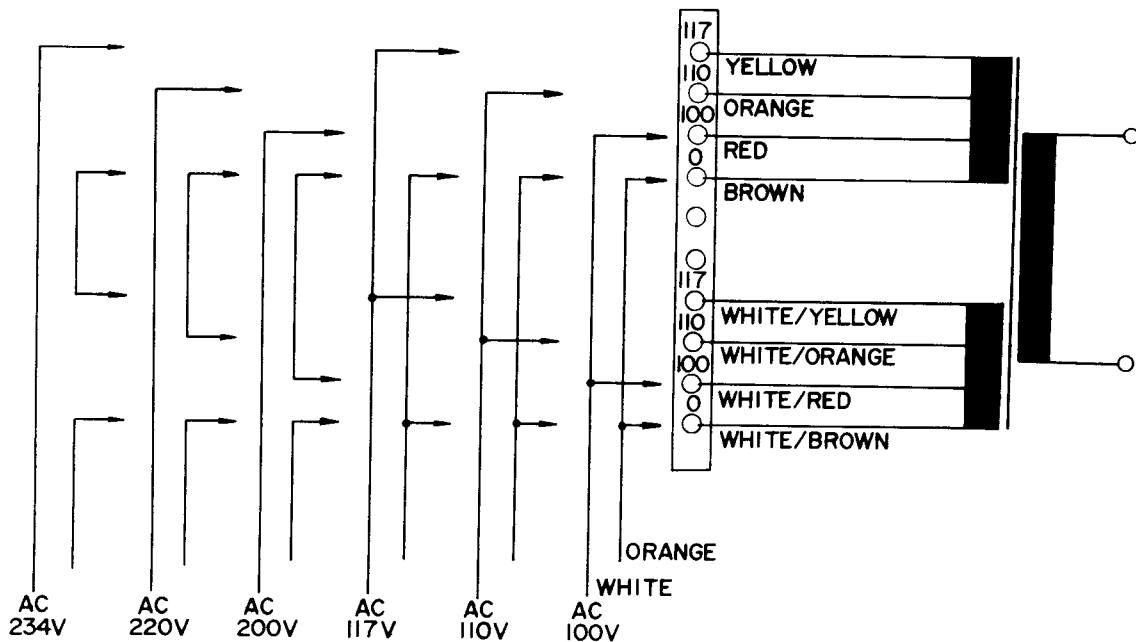

Figure 3: Transformer Primary Wiring

CONTROLS AND SWITCHES

The transceiver has been specifically designed for flexible operation and versatility. All internal controls have been preset at factory. Several of the controls are unusual in operation, and improper adjustment may result in poor quality signals. The

various front panel controls and their functions are described in the following section. Be certain that you thoroughly understand the function of each control before operating the transceiver.

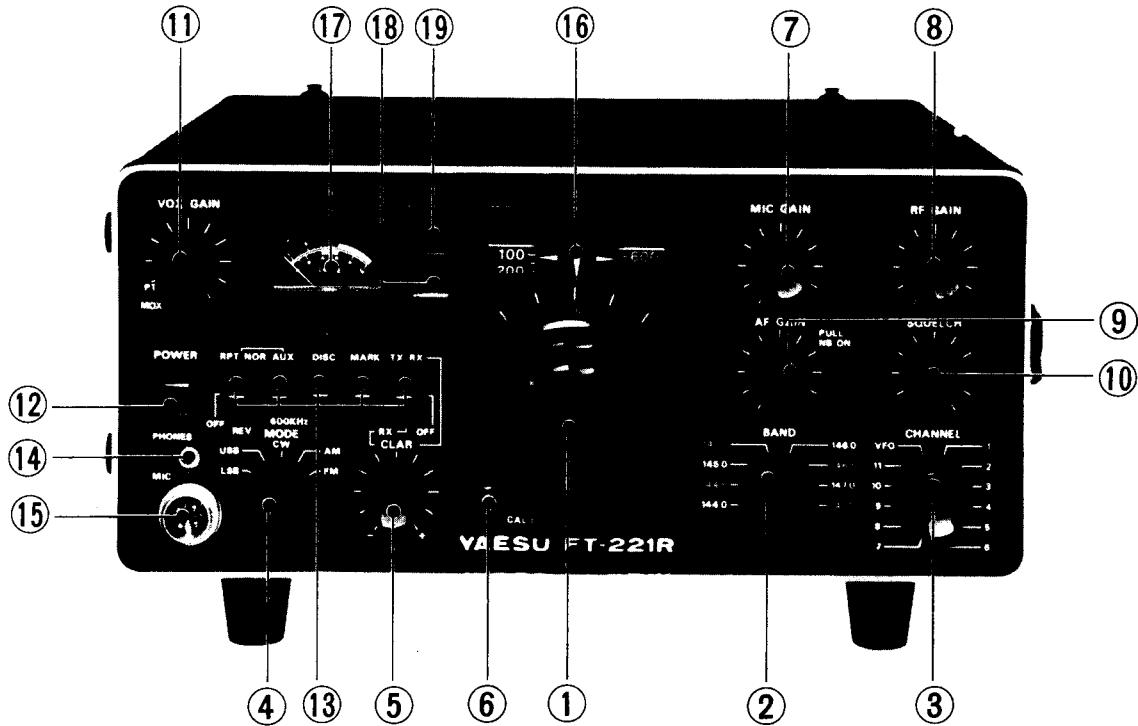

Figure 4 : Front Panel Controls & Switches

(1) MAIN TUNING control

The tuning knob, located below the dial window, determines the actual frequency of operation in combination with the BAND switch. A dual rate, concentric dial drive system is employed for a coarse and fine setting of the operating frequency.

(2) BAND switch

The BAND switch is an eight-position switch that selects one of the 500 kHz segments in two meter amateur band.

These segments are:

| | |
|-------|---------------------|
| 144.0 | : 144.0 ~ 144.5 MHz |
| 144.5 | : 144.5 ~ 145.0 MHz |
| 145.0 | : 145.0 ~ 145.5 MHz |
| 145.5 | : 145.5 ~ 146.0 MHz |
| 146.0 | : 146.0 ~ 146.5 MHz |
| 146.5 | : 146.5 ~ 147.0 MHz |
| 147.0 | : 147.0 ~ 147.5 MHz |
| 147.5 | : 147.5 ~ 148.0 MHz |

(3) CHANNEL switch

The CHANNEL switch selects one of 11 crystals for crystal controlled operation. This switch also selects the VFO for continuous tuning with the main tuning knob.

(4) MODE switch

The MODE switch is a five-position switch. This switch selects the mode of operation: LSB (lower side band SSB), USB, (upper side band SSB), CW (code operation), AM (amplitude modulation) and FM (frequency modulation).

(5) CLARIFIER control

The CLARIFIER control provides a means of OFF setting the receiver frequency approximately 4 kHz to either side of the transmitting frequency. Thus it is possible to set the pitch of the voice or signal you are receiving to the most readable point without affecting your transmitting frequency. Its

use is particularly valuable in "net" operation when several participants may be transmitting slightly off frequency. The CLARIFIER control may be switched off with CLARIFIER switch and the receiver locked to the transmitting frequency. Normally you will want to keep the CLARIFIER in the OFF position until the initial contact is made. The CLARIFIER switch may also be used to change both transmitting and receiving frequencies simultaneously when the CLARIFIER switch is put in the TX-RX position.

(6) CALIB.

When depressed, this button locks the 1 kHz dial for dial calibration.

(7) MIC GAIN control

The MIC GAIN control varies the audio level from the microphone amplifier stages. The control has sufficient range to permit the use of any 600 ohm dynamic microphone.

(8) RF GAIN control

The RF GAIN control varies the gain of the receiver RF and IF amplifiers. Maximum sensitivity is obtained when the control is set to the fully clockwise position.

(9) AF GAIN control & switch

The AF GAIN control adjusts the audio output level to the speaker and phone jack. Clockwise rotation increases the audio output. When the knob is pulled out, the noise blanker is activated in order to minimize pulse type noises.

(10) SQUELCH control

This control adjusts the receiver squelch threshold level.

(11) VOX GAIN control & switch

This controls the VOX gain and functions for push to talk, stand-by or manual operation.

(12) POWER switch

The POWER switch turns transceiver "ON" and "OFF" for both AC and DC operation.

(13) FUNCTION switches

RPT

This switch is used for repeater operation.

In the NOR (normal) position, the transmitter frequency shifts 600 kHz down and in the REV (reverse) position, the receiver frequency shifts 600 kHz up.

AUX/600 kHz

Selects the repeater shift frequency. In the 600 kHz position, the TX or RX frequency shifts 600 kHz with the REPEATER switch ON. Any split within 1 MHz can be installed as option. Refer to Repeater Operation paragraph on Page 12.

DISC

This switch selects the meter to read discriminator center current for FM reception.

MARK

100 kHz calibrator switch.

CLAR

Clarifier switch. Turns the CLARIFIER on in upper position, and off in middle position. In the TX-RX position, the CLARIFIER works for both transmit and receive.

(14) PHONE jack

Phone jack for an external headphones or speaker. The internal speaker is disconnected when the headphone plug is inserted.

(15) MIC jack

The microphone supplied is the recommended one for use with the transceiver, however any microphone having a 500 to 600 ohm impedance may be used.

(16) DIAL

Dial window for frequency readout. The coarse scale indicates 100 kHz increments and fine scale indicates 1 kHz increments.

(17) METER

The meter indicates signal strength, FM discriminator center current in receive and relative power output in transmit.

(18) CLAR lamp

This lamp lights when the CLARIFIER is in use.

(19) RPT lamp

This lamp lights when the repeater switch is ON.

REAR PANEL CONNECTIONS

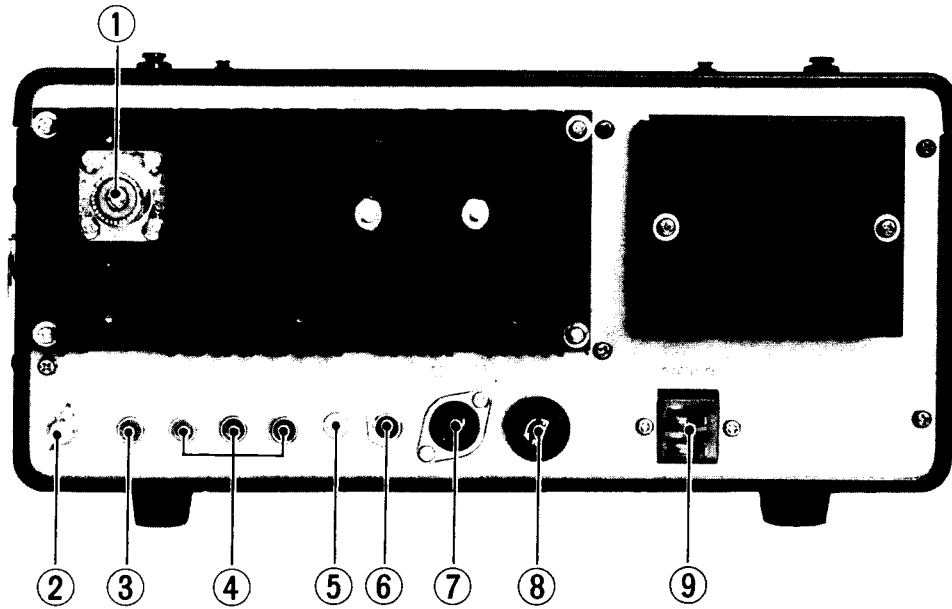

Figure 5 : Rear Panel Connections

(1) ANT

Coaxial connector for an antenna.

(2) GND

Ground connection.

(3) ALC

ALC (automatic level control) input.

(4) RL

Relay contacts for the control of external equipment.

(5) SP jack

External speaker audio output.

(6) KEY jack

Key jack for code operation.

(7) TONE-IN

Tone-pad input jack.

(8) FUSE

Fuse holder. For AC operation, a 2 amp fuse is used on 100/117 volts and, a 1 amp fuse on 200/234 volts.

(9) POWER receptacle

Both AC and DC cables are supplied with the transceiver.

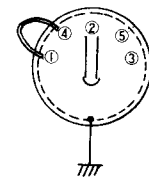
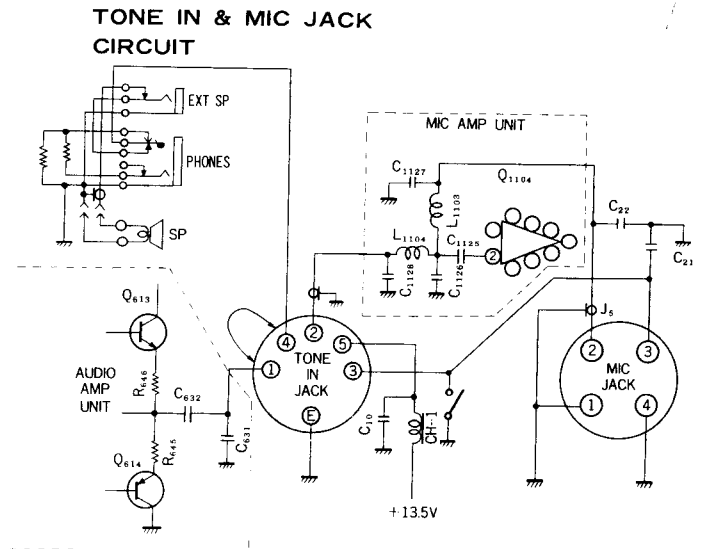

Tone in Plug
Figure 6

OPERATION

The tuning procedure of the transceiver is not complicated, however care should be exercised when tuning to insure peak performance of the equipment. The following paragraphs describe the procedure for receiver and transmitter tuning.

INITIAL CHECK

Before connecting the transceiver to a power source, carefully examine the unit for any visible damage. Check that all modules and crystals are firmly in place and that controls and switches are operating normally. Ensure that voltage specification marked on the rear panel matches the supply voltage.

DIAL READOUT

The main tuning dial is color coded with the band selector switch for proper frequency readout. When the band selected is marked in white on the transceiver front panel, the operator reads the white scale on the main tuning drum. When the band selected is marked in amber the operator reads the amber scale. The main tuning drum is marked in 50 kHz increments. This provides a coarse frequency setting within the band. The round subdial on the dial window surrounding the tuning knob is scaled in 1 kHz increments and provides fine settings of the transceiver operating frequency. The following example will familiarize yourself with the relationship of main and subdial frequency readout.

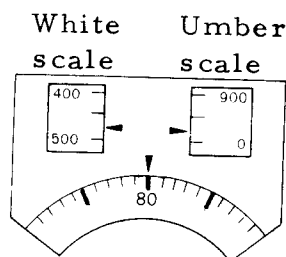

Figure 7

Read the white scale on main dial for the bands 144.0, 145.0, 146.0 and 147.0, and amber scale for 144.5, 145.5, 146.5 and 147.5.

Then the setting shown in the example would be 144.480 MHz on 144.0 BAND switch setting, and 145.480 MHz on 145.0. And also the frequency would be 144.980 MHz on 144.5 BAND switch setting, and 145.980 MHz on 145.5.

RECEIVER

After the transceiver is properly set up for operation, set the controls and switches as follows;

- POWER Down to "OFF" position.
- MODE Desired mode.
- BAND Desired band.
- RPT Lever position horizontal to OFF position.
- AUX-600 kHz Lever position horizontal to 600 kHz shift
- DISC Lever position horizontal to OFF position.
- MARK Lever position horizontal to OFF position.
- CALR Lever position horizontal to OFF position.
- NOR-REV "NOR" position.
- MAIN TUNING DIAL Desired operating frequency.
- VOX GAIN PTT.
- AF GAIN Desired audio level.
- RF GAIN Fully clockwise position.
- CHANNEL VFO.
- SQUELCH Fully counter-clockwise position.

Connect the cord supplied to the appropriate power source, and an antenna to antenna connector on the rear panel.

CAUTION

PERMANENT DAMAGE WILL RESULT IF IMPROPER SUPPLY VOLTAGE IS APPLIED TO THE TRANSCEIVER. WARRANTY DOES NOT COVER THE DAMAGE CAUSED BY IMPROPER SUPPLY VOLTAGE.

Turn on the POWER switch. The dial and meter lamps should light up, and the transceiver is now ready to operate.

(1) SSB and AM Modes

Using the main tuning control (VFO), tune in an incoming signal. USB (upper side band) is mostly used for 2 meter SSB operation. When the received signal can not be heard clearly, then change to the opposite side band. The RF GAIN control is normally set to the fully clockwise position, but if the incoming signal is extremely strong, it is recommended to turn this control back to prevent overload of the front end. When there is noise caused by automobiles, pull the AF GAIN control out to switch on the NB (noise blanker) in order to eliminate these pulse type noises.

(2) CW Mode

With the CLARIFIER switch in the OFF position, tune in a signal until an 800 Hz beat tone is heard. Under this condition, your transmitting frequency coincides with the received signal. If you desire to hear a beat tone of your choice, then use the CLARIFIER control.

(3) FM Mode

Using the tuning control, tune in an incoming signal for a maximum and steady S-Meter reading where a natural voice is heard. For accurate tuning, set the DISC switch to the upper ON position. Carefully readjust the tuning control until the meter indicates zero (half way of the full scale).

If the S-Meter indication wobbles or if a clean audio output is not available, it is very likely that the signal is in the SSB mode. In this case, turn the MODE switch to USB or LSB position, and carefully tune the tuning control until a clear voice is heard. It is important that the CLARIFIER switch be set to the OFF position when calling the another station. After the initial contact is made, then the CLARIFIER may be used for the desired listening sound.

FREQUENCY CALIBRATION

(1) SSB Mode

Set the CLARIFIER to the OFF position, and the tuning control to the 100 kHz point on the dial nearest to the desired frequency. Set the MARK switch to the upper position. While pressing the CALIB knob to lock the dial, tune the tuning control for a zero beat. The transceiver must be recalibrated when changing the mode of operation: USB, LSB, AM or CW.

(2) FM Mode

Set the CLARIFIER to the OFF position, and the tuning control to the 100 kHz point in the round dial nearest to the desired operating frequency. Set the MARK switch and DISC switch to ON position. While pressing the CALIB knob down to lock the dial, tune the main tuning control until the meter indicates the green portion of its scale.

NOTE: WHEN THE MARKER SWITCH IS IN THE "ON" POSITION, THE ANTENNA IS DISCONNECTED FOR EASIER CALIBRATION.

TRANSMITTER

Connect a 50 ohm dummy load or a matched antenna to the coaxial fitting on the rear panel. Since the transmitter section utilizes wide band techniques no tuning control is necessary except the main tuning control to select the operating frequency. Plug the microphone into the MIC jack and select the desired mode. Push down the PTT (push-to-talk) switch on the microphone and speak into the microphone.

(1) SSB Mode

The meter indicates maximum deflection on voice peak and zero with no microphone input. Release the PTT switch for receive. Excessive setting of the MIC GAIN will result in poor quality transmitted signals.

(2) AM Mode

When the PTT switch is depressed, the proper amount of carrier is automatically inserted. Adjust the MIC GAIN control until the meter indicates a very slight movement with voice peaks while speaking into the microphone normally.

(3) CW Mode

Plug the key into the KEY jack on the rear panel. In the key down condition, the meter will show a 6 to 8 relative power output, and with the key up, the receiver will recover. The break-in delay time may be adjusted with VR₆₀₁, under the top cover.

(4) FM Mode

Set the MIC GAIN control to the 12 o'clock position and push the PTT switch on the microphone while speaking normally into the microphone. The meter will show a 6 to 8 relative power output. Release the PTT switch on the microphone for receive.

(5) VOX (Voice Controlled) Operation

Adjust the VOX GAIN control on the front panel until your voice actuates the transmitter while speaking normally into the microphone. Set the ANTITRIP control to the minimum point in order to prevent the speaker output from tripping the VOX circuit. Do not use more VOX GAIN or ANTITRIP GAIN than necessary. Adjust the DELAY control for a suitable release time. The RELAY control provides coarse adjustment for

relay sensitivity and this control has been preset at factory. These controls are located on the AF AMP UNIT under the top cover.

REPEATER OPERATION

Transmitting and receiving frequencies may be shifted 600 kHz for repeater operation. When the REPEATER switch is ON (upward position) with NOR-REV switch in the NOR (normal) position, the transmitted frequency is shifted 600 kHz down from the dial readout. With the NOR-REV switch at REV position, the received frequency is shifted 600 kHz down from the dial readout. The U.S. model has an automatic cross-over system in which this shift is automatically reversed from 147.0 to 148.0 MHz.

In NOR operation, the transmitting frequency is shifted 600 kHz down for the frequency range of 146.61 through 146.97 MHz and shifted 600 kHz up for the frequency range of 147.00 through 147.39. This is shown on the chart on Figure 8. These relations are reversed with the NOR-REV switch in the REV position. Extreme caution should be observed so as not to transmit outside

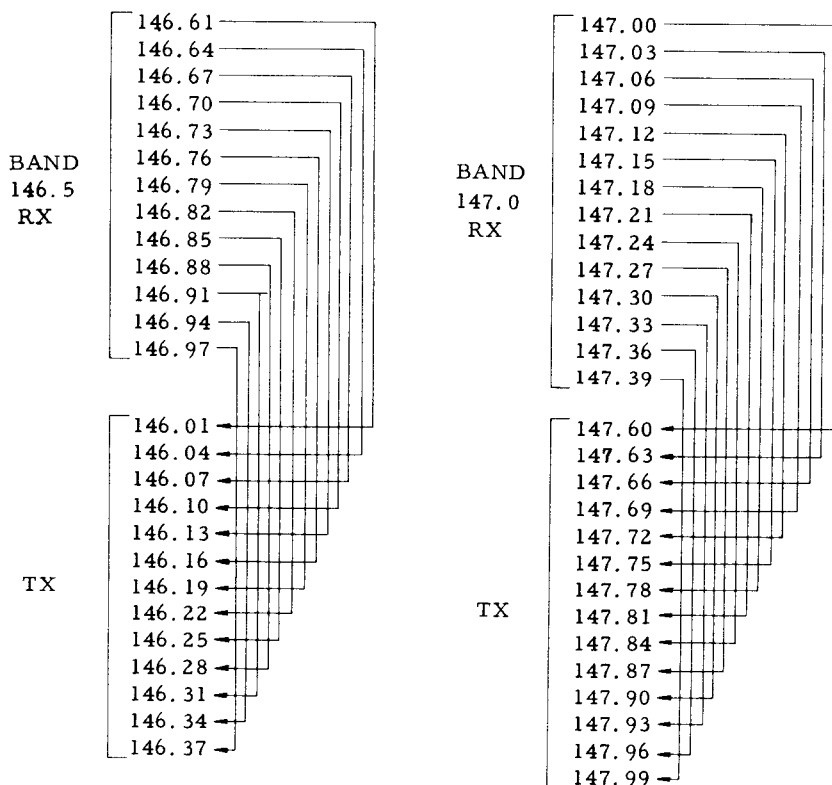

Repeater Frequency Chart for U.S. Model

Figure 8

the amateur bands with repeater switch ON. The most repeaters use 600 kHz split between transmitter and receiver frequencies, however, other split than 600 kHz has been adopted in some areas.

When the AUX/600 kHz switch is in the AUX position, the frequency is shifted to any frequency within 1 MHz determined by the optional crystal installed in the local unit. The RPT lamp lights up when the repeater switch is ON.

Tone actuated repeaters can be operated with the built-in tone burst signal which is automatically inserted by the push-to-talk switch at the start of a transmission. When the microphone PTT switch is depressed for 0.2 – 0.5 seconds before the voice transmission, the burst tone signal is inserted at the beginning of the transmission. Normal operation of the PTT switch does not generate the burst signal. The frequency of the burst signal may be adjusted from 1500 to 2000 Hz with VR₁₀₀₂ under the top cover.

AUX crystal specification is calculated as follows:

$$\text{BAND } 146.5 ; X \text{ MHz} = (127.8 - \text{shift frequency}) \div 9$$

$$\text{BAND } 147.0 ; X \text{ MHz} = (128.3 + \text{shift frequency}) \div 9$$

Example 1

Calculate crystal frequency for –800 kHz shift in 146.5 MHz segment.

(TX frequency 800 kHz lower)

$$X \text{ MHz} = (127.8 - 0.8) \div 9 = 14.111 \text{ MHz}$$

Example 2

Calculate crystal frequency for +800 kHz shift in 147.0 MHz segment.

(TX frequency 800 kHz higher)

$$X \text{ MHz} = (128.3 + 0.8) \div 9 = 14.344 \text{ MHz}$$

CRYSTAL CONTROLLED OPERATION

In addition to the normal VFO controlled operation, eleven crystals may be selected by the channel switch on the front panel for crystal controlled operation. This crystal controlled operation is of great advantage when the transceiver is operated on the preset frequencies. Since the entire 2 meter band has been split into eight bands, eleven crystals can be used as 88 crystal controlled channels.

The crystal holders accept standard, HC-25/U type crystals. All crystal frequencies must fall between 8,000 kHz and 8,500 kHz. A trimmer capacitor has been connected in series with each crystal to permit proper frequency adjustment. Adjustment of this trimmer will change the crystal frequency approximately 1 kHz. The correct crystal frequency for any desired operating frequency may be determined by using the following formula:

$$f_x = f_o - f_1$$

where f_x : crystal frequency
 f_o : operating frequency
 f_1 : given from Table 1

| BAND (MHz) | LSB (kHz) | USB (kHz) | FM (MHz) |
|-------------|-----------|-----------|----------|
| 144.0–144.5 | 136001.5 | 135998.5 | 136.0 |
| 144.5–145.0 | 136501.5 | 136498.5 | 136.5 |
| 145.0–145.5 | 137001.5 | 136998.5 | 137.0 |
| 145.5–146.0 | 137501.5 | 137498.5 | 137.5 |
| 146.0–146.5 | 138001.5 | 137998.5 | 138.0 |
| 146.5–147.0 | 138501.5 | 138498.5 | 138.5 |
| 147.0–147.5 | 139001.5 | 138998.5 | 139.0 |
| 147.5–148.0 | 139501.5 | 139498.5 | 139.5 |

Table 1

Example (1)– Find the proper crystal frequency for 144.15 MHz USB operation

From the Table 1, f_1 for USB is 135998.5.

$$\text{Therefore, } f_x = 144.15 - 135.9985 = 8151.5 \text{ kHz}$$

Example (2)– 144.72 MHz FM operation

$$f_x = 144.72 - 136.5 = 8220 \text{ kHz}$$

FT-221 BLOCK DIAGRAM

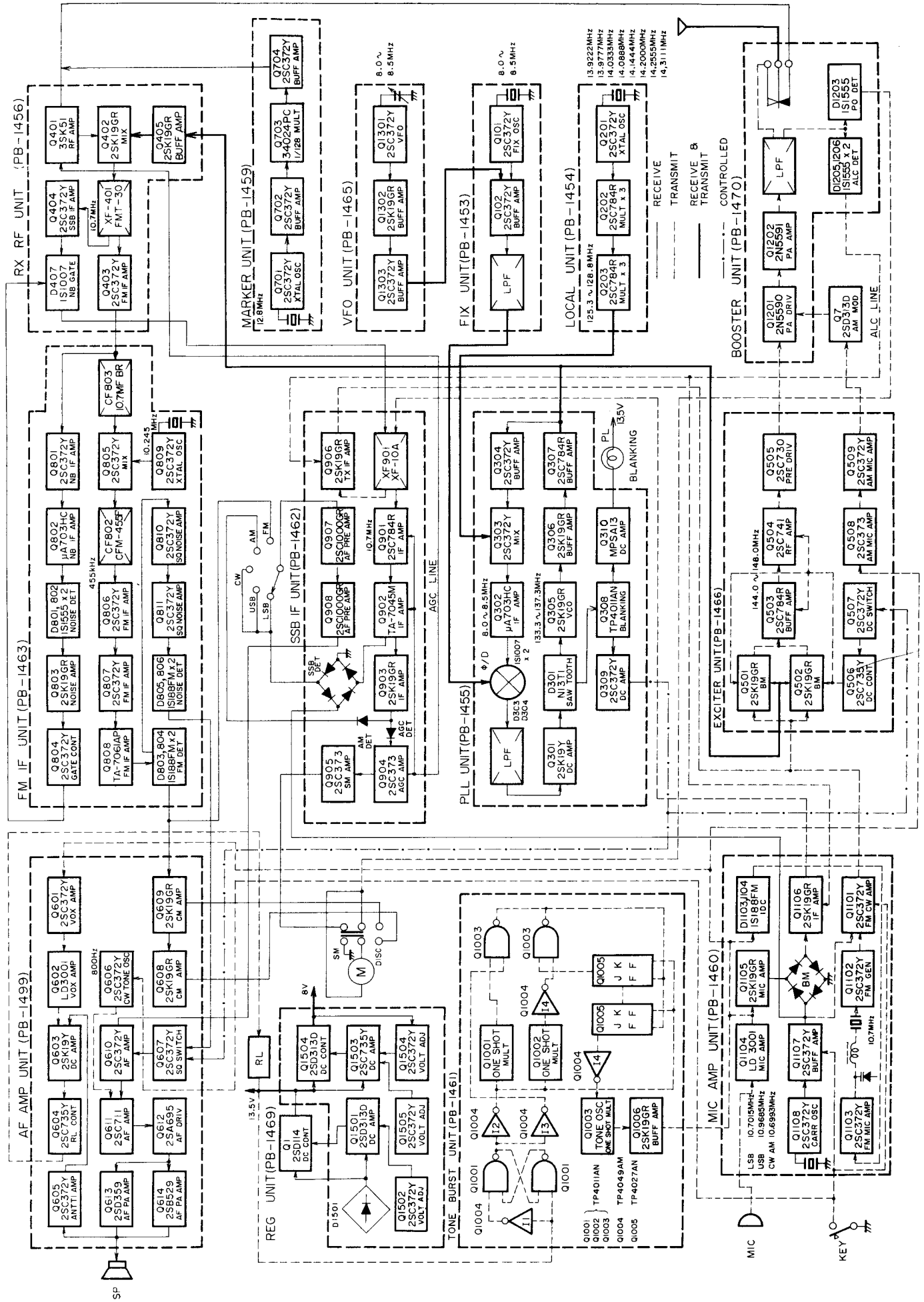

CIRCUIT DESCRIPTION

GENERAL

The block diagram and the circuit description that follows will provide you with a better understanding of this transceiver. Computer type plug-in modules have been adopted throughout the transceiver.

The transceiver consists of a single conversion receiver with a 10.7 MHz IF for SSB, CW and AM, a double conversion receiver with a 10.7 MHz first IF and 455 kHz second IF for FM. A single conversion transmitter, utilizing a 10.7 MHz high frequency crystal filter for SSB generation and varactor diode frequency modulation on 10.7 MHz crystal oscillator is incorporated.

NOTE:

The parts number starts with the number shown below the printed board designation. For example, the field effect transistor 3SK51 in RX RF unit PB-1456 is Q₄₀₁.

RECEIVER

RX RF UNIT (PB-1456)

The 144 MHz input signal from the antenna is fed through the antenna relay, RL₁₂₀₁, to pin 5 of the RX RF unit. The signal is amplified by the RF amplifier Q₄₀₁, 3SK51 field effect transistor, and then fed to the gate of the first mixer Q₄₀₂, 2SK19GR, where the input signal is heterodyned with a 133.3 MHz to 137.3 MHz signal, delivered from phase-lock-loop unit, and thus produces an IF signal of 10.7 MHz at the drain circuit of Q₄₀₂.

The input and output circuits of the RF amplifier utilize a double tuned circuit, which is sharply tuned to the center of the band with the varactor diodes, D₄₀₁ through D₄₀₄, thus eliminating cross modulation and intermodulation effects.

The IF signal passes through crystal filter XF401, FMT-30, and the SSB, AM and CW signal is then fed to the first IF amplifier Q₄₀₄, 2SC372Y, while the FM signal is fed to Q₄₀₃, 2SC372Y.

The SSB, AM and CW signal amplified by Q₄₀₄ is fed through a noise blanker gate diode D₄₀₇, 1S1007, to pin 14, and the FM signal amplified by Q₄₀₃ is fed to pin 9.

SSB IF UNIT (PB-1462)

The SSB, AM and CW signal from pin 14 of the RX RF unit is fed through pin 3 to the SSB IF unit. The signal is fed through the diode switch and a crystal filter, XF-9, to the IF amplifier Q₉₀₁, 2SC784R. The signal is amplified by Q₉₀₁ and Q₉₀₂, TA7045M, and then fed to the ring demodulator consisting of D₉₀₄ through D₉₀₇, 1S1007, where a carrier signal is applied through pin 32 from the carrier oscillator in the MIC AMP unit.

The audio output is fed through pin 33 and the MODE switch, S3D, to pin 28 of the same unit. The IF signal is further amplified by Q₉₀₃, 2SK19GR, and detected by the AM detector D₉₁₀, 1S188FM, for AM mode. Then the audio signal is fed through pin 25 to the MODE switch S3D.

A part of the IF signal output from Q₉₀₃ is rectified by D₉₀₈, 1S1007, and D₉₁₃, 1S1555, for AGC (automatic gain control). The AGC voltage is amplified by Q₉₀₄ and Q₉₀₅, 2SC373 and controls the gain of IF amplifier Q₉₀₁ and Q₉₀₂. A part of

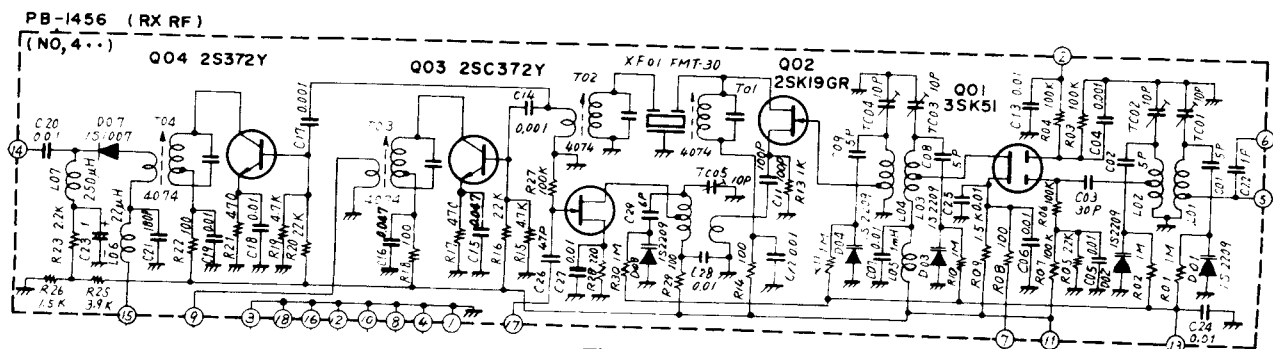

Figure 10

it is fed through pin 17 to the RX RF unit to control the gain of the RF amplifier Q₄₀₁. The AGC voltage is amplified by the S-meter amplifier Q₉₀₅, 2SC373, and fed to the S-meter through the DISC/SM switch on the front panel.

The audio signal from the MODE switch is pre-amplified by Q₉₀₇ and Q₉₀₈, 2SC1000GR and fed through pin 29 to the AF AMP unit.

FM IF UNIT (PB-1463)

The FM IF signal from pin 17 of this unit is fed through a ceramic filter CF₈₀₃, 10.7 MFBR to the second mixer Q₈₀₅, 2SC372Y, where the 10.7 MHz signal is mixed with the 10.245 MHz signal generated by the second heterodyne oscillator Q₈₀₉, 2SC372Y, producing a 455 kHz second IF signal. The 455 kHz IF signal is fed through the ceramic filter, CF₈₀₂, to the second IF amplifier Q₈₀₆ and Q₈₀₇, 2SC372Y, and the amplifier limiter

Q₈₀₈, TA7061AP, which removes any amplitude modulation component on the signal. The output from Q₈₀₈ is applied to the discriminator D₃₀₄ and D₃₀₅, 1S188FM. The discriminator produces an audio output in response to a corresponding frequency (or phase) shift in the 455 kHz IF signal. The discriminator output is then fed to the common audio amplifier stage in SSB IF unit through the MODE switch.

For FM reception, when no carrier is present in the 455 kHz IF, the noise at the discriminator output is fed through the squelch threshold potentiometer, VR₆, to the noise amplifier Q₈₁₀ and Q₈₁₁, 2SC372Y, and detected by D₈₀₅ and D₈₀₆, 1S188FM. The DC voltage is applied from pin 8 to the squelch controller Q₆₀₇, 2SC372Y, in the AF AMP unit.

The 10.7 MHz signal is also applied to the noise blanker amplifier Q₈₀₁, 2SC372Y. The signal is amplified by Q₈₀₁, 2SC372Y, and Q₈₀₂, μ A703HC.

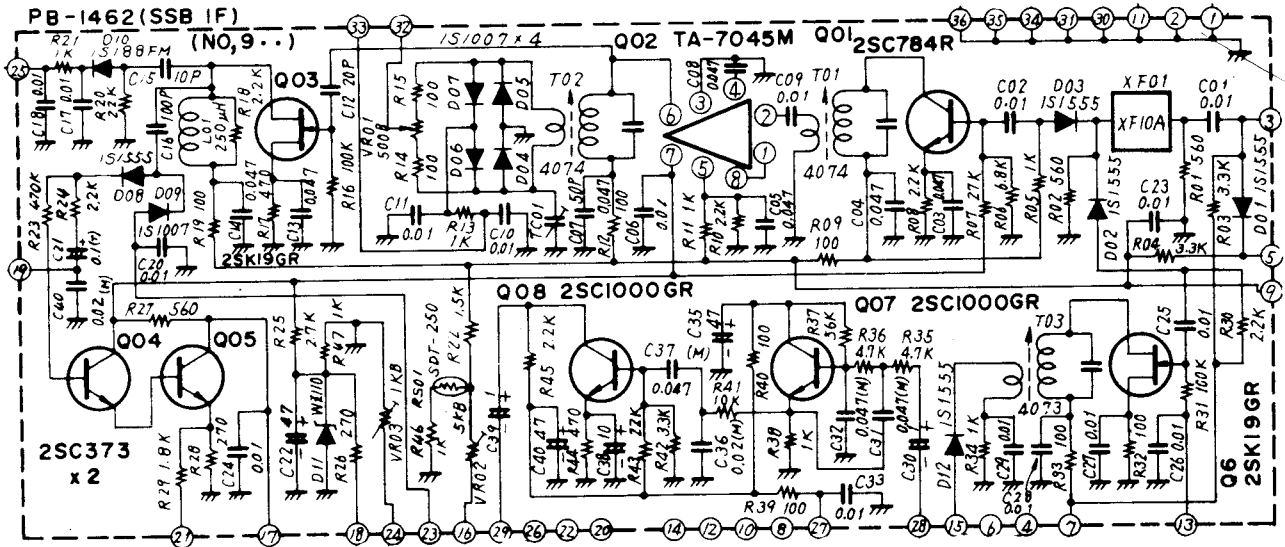

Figure 11

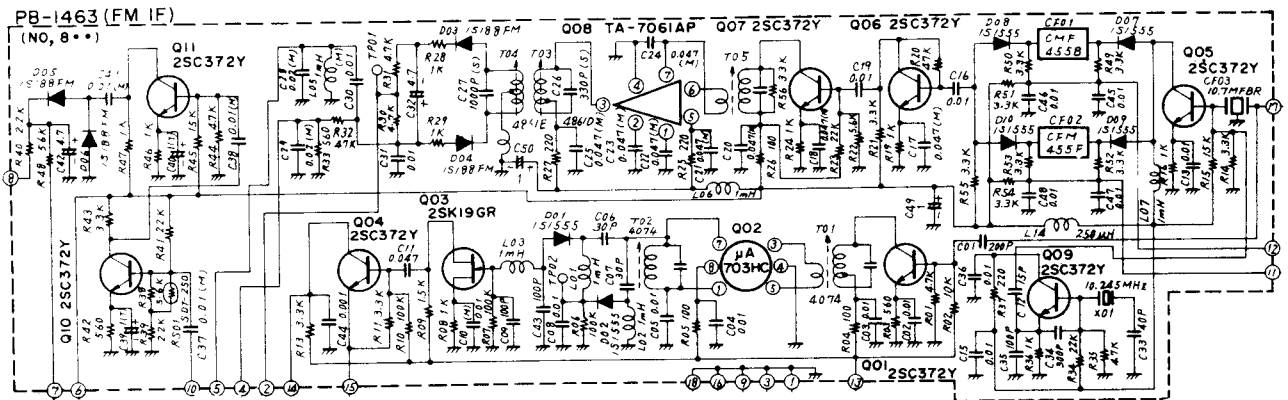

Figure 12

The noise rectifier diodes D_{801} and D_{802} , 1S1555, produce a DC voltage which is amplified by following noise pulse amplifier Q_{803} , 2SK19GR.

Under normal conditions, Q_{803} conducts producing the cut-off voltage to the base of the gate controller Q_{804} , 2SC372Y, in turn the high collector voltage of Q_{804} is supplied from pin 15 to the gate diode D_{407} , 1S1007, in the RX RF unit which conducts to pass the signal freely. With pulse noise, Q_{804} conducts and its collector voltage drops causing the gate diode D_{407} to disconnect the IF signal during the noise pulse exists.

AF AMP UNIT (PB-1499)

The audio signal pre-amplified in the SSB IF unit is fed through pin 13 to the audio amplifier stage consisting of Q_{610} , 2SC372Y, Q_{611} , 2SC711, Q_{612} , 2SA695, Q_{613} , 2SD359 and Q_{614} , 2SB529. The audio power amplifier circuit utilizes the OTL (output transformer less) circuitry and delivers 2 watts output to the speaker from pin 8.

In the FM mode, the squelch voltage is applied from pin 12 to the squelch controller Q_{607} , 2SC372Y, which conducts with noise when the signal is not present, in turn the audio input is grounded to quiet the audio amplifier. When the signal is present, the Q_{607} is cut-off and permits normal operation of the audio amplifier.

The DC voltage is also applied from pin 12 to quiet the audio amplifier when the phase lock loop circuit is unlocked.

The speech output from the first microphone amplifier is fed through the VOX GAIN control potentiometer, VR_7 , to the VOX amplifier Q_{601} , 2SC372Y, and Q_{602} , LD-3001, from pin 2.

The amplified signal is fed to the VOX rectifier, D_{601} and D_{602} , 1S1555. The rectified DC voltage is applied to the gate of the VOX relay controllers Q_{603} , 2SK19Y, and Q_{604} , 2SC735Y, causing them to conduct and actuate the VOX relay, RL_1 , on the main chassis.

The ANTITRIP circuit provides a threshold voltage to prevent the speaker output from tripping the transceiver into the transmit mode. The receiver audio output voltage is connected through the ANTITRIP potentiometer, VR_{603} , to the antitrip amplifier Q_{605} , 2SC372Y, and fed to rectifiers, D_{603} and D_{604} , 1S1555. The negative DC output voltage from the rectifier is connected to the gate of Q_{603} , and reduces the gain of the VOX control transistor, thus providing the necessary antitrip threshold. The ANTITRIP control, VR_{603} , adjusts the value of the antitrip voltage threshold so that the speaker output will not produce an excessive positive voltage from the VOX rectifier that exceeds the negative voltage from the antitrip rectifier causing the controller transistor to actuate the relay. When speaking into the microphone, the

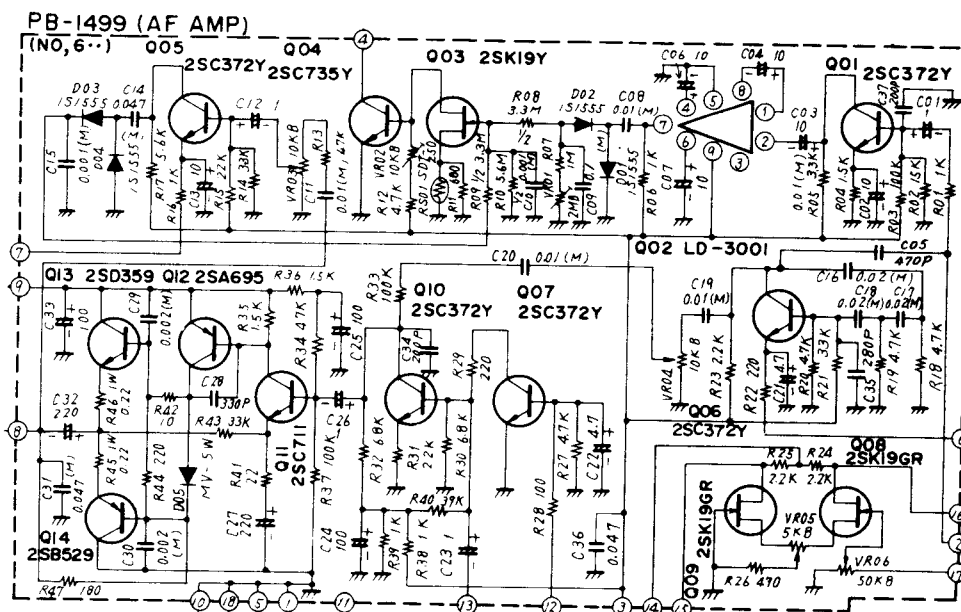

Figure 13

positive voltage will exceed the negative antitrip voltage and actuate the relay. VR₆₀₂ provides coarse adjustment for relay sensitivity.

Relay hold tone will be determined by the DELAY control potentiometer, VR₆₀₁.

The tone oscillator Q₆₀₆, 2SC372Y, operates when the MODE switch is in the CW position. It is a phase shift oscillator operating at approximately 800 Hz.

The tone output is activated by the keying circuit through the emitter circuit of Q₆₀₆ and coupled through sidetone level control, VR₆₀₄, to the receiver audio amplifier, Q₆₀₁, for sidetone monitoring in CW operation. The output from Q₆₀₆ is also coupled to the VOX amplifier, Q₆₀₂, for break-in CW operation. In the FM mode, a DC voltage at the discrimination output is applied from pin 17, to the differential amplifier Q₆₀₈ and Q₆₀₉, 2SK19GR.

When the frequency of received signal is shifted from the discriminator center, the resulting DC voltage causes either Q₆₀₈ or Q₆₀₉ to conduct indicating the amount of shift on the meter with the DISC switch in the ON position. VR₆₀₅ balances the differential amplifier and VR₆₀₆ calibrates the sensitivity of the meter.

TRANSMITTER

MIC AMP UNIT (PB-1460)

The speech signal from the microphone is fed from pin 31 to the first microphone amplifier, half of Q₁₁₀₄, LD-3001. The input impedance of the microphone amplifier is 600 ohms. This signal is controlled in amplitude by the MIC GAIN control between pins 29 and 31, and is amplified by the second microphone amplifier, the other half of Q₁₁₀₄, and applied to the source follower Q₁₁₀₅, 2SK19GR, to be delivered to the ring modulator D₁₁₀₈ through D₁₁₁₁, 1S1007.

The carrier oscillator Q₁₁₀₈, 2SC372Y, oscillates at 10.7015 MHz for LSB, 10.6985 MHz for USB and 10.6993 MHz for AM/CW depending upon the MODE switch position. In the CW mode, the carrier oscillator oscillates at 10.6993 MHz for transmit and 10.6985 MHz for receive producing an 800 Hz beat note in the receive mode. In the AM mode, the carrier oscillator does not function while receiving. The MODE switch selects the crystal by means of a diode switch. The output from the oscillator is fed through the buffer amplifier Q₁₁₀₇, 2SC372Y to the balanced ring modulator D₁₁₀₈ through D₁₁₁₁, 1S1007. The

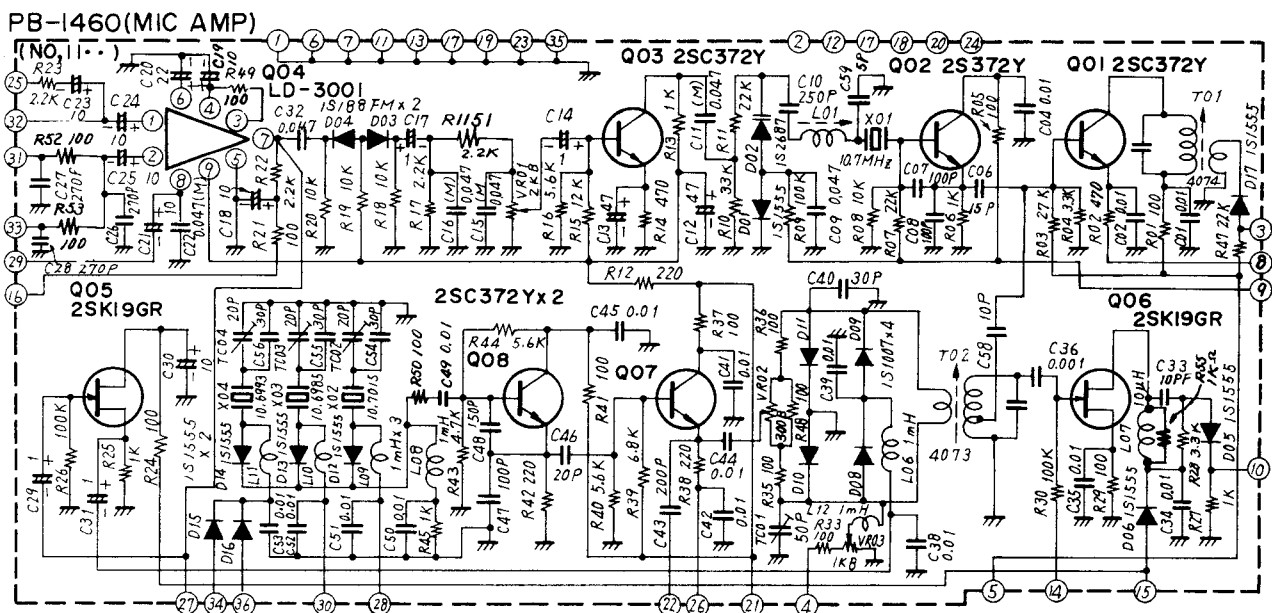

Figure 14

carrier signal output from the buffer amplifier, Q₁₁₀₇, is fed from pin 22 to the SSB IF unit for SSB and CW reception. Carrier balance is obtained with potentiometer, VR₁₀₀₂, and the trimmer capacitor, TC₁₁₀₁. The double side band, suppressed carrier signal is amplified by Q₁₁₀₆, 2SK19GR, and fed from pin 10 to pin 5 of the SSB IF unit. In the AM and CW modes, the balanced modulator is unbalanced by the DC voltage applied from pin 4 and the carrier signal is fed through T₁₁₀₂ to carrier amplifier Q₁₁₀₁, 2SC372Y. The amplified carrier is fed from pin 3 to the EXCITER unit.

The audio signal output from Q₁₁₀₄ is fed from pin 27 to pin 12 of the EXCITER unit to be amplified to a sufficient level for low level AM modulation.

In the FM mode, a crystal oscillator Q₁₁₀₂, 2SC372Y, generates a 10.7 MHz signal which is shifted by the varactor diode D₁₁₀₂, 1S2687, in accordance with the speech voltage. The audio signal from the microphone amplifier, Q₁₁₀₄, is applied to the IDA (instantaneous deviation adjustment) circuit. The IDA circuit, composed of diodes D₁₁₀₃ and D₁₁₀₄, 1S188FM, clips both positive and negative peaks when they exceed a pre-determined level in order to limit the maximum deviation of the transmitter.

The limited audio signal is applied through a low pass filter and deviation potentiometer, VR₁₁₀₁, to the audio amplifier Q₁₁₀₃, 2SC372Y, where it is

amplified and applied to the modulator, varactor diode D₁₁₀₂. The low pass filter limits the transmitter modulation spectrum by attenuating the frequencies above the speech range.

The frequency modulated signal is then amplified by Q₁₁₀₁, 2SC372Y, and fed through the output transformer T₁₁₀₁ to pin 5 of the EXCITER unit.

When the MODE switch is in the CW position, the emitter circuit of Q₁₁₀₇ and Q₁₁₀₁ are connected to the key jack through pin 8 and pin 26.

EXCITER UNIT (PB-1466)

The SSB, AM, CW and FM output signal (10.7 MHz) from the MIC AMP unit is fed to the EXCITER unit from pin 3 and pin 5.

The 10.7 MHz signal is fed to the balanced mixer, consisting of Q₅₀₁ and Q₅₀₂, 2SK19GR, where the signal is mixed with the 133.3 to 137.3 MHz heterodyne signal delivered from pin 4, producing a 144 to 148 MHz signal. The output signal from the balanced mixer passes through the tuned circuits consisting of L₅₀₁ through L₅₀₄, which are tuned by the varactor diodes D₅₀₁ through D₅₀₄, 1S2209, in which voltages are preset in accordance with the band switch position. Thus the circuit is tuned exactly to the operating frequency com-

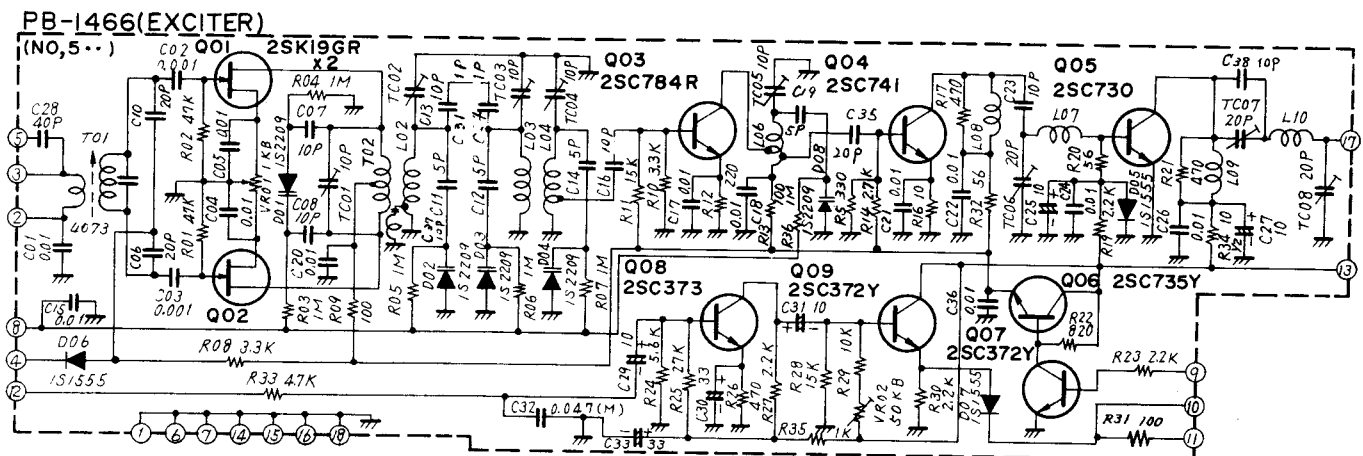

Figure 15

pletely reducing any spurious radiation. The signal is then amplified by the amplifier chain Q_{503} , $2SC784R$, Q_{504} , $2SC741$, and Q_{505} , $2SC730$, and delivered from pin 17 to the BOOSTER unit.

The DC voltage for Q_{501} through Q_{504} is supplied through Q_{506} , $2SC735Y$. When the phase lock loop circuit is unlocked, the controller transistor Q_{507} , $2SC372Y$, stops conducting and in turn Q_{506} stops supplying the DC voltage for Q_{501} through Q_{504} .

The speech signal from pin 27 of the MIC AMP unit is fed through the AM amplifier Q_{508} , $2SC373$, and emitter follower Q_{509} , $2SC372Y$, to the AM modulator Q_7 , $2SD313D$, which controls the supply voltage for Q_{1201} , $2N5590$, in the BOOSTER unit.

BOOSTER UNIT (PB-1470)

The signal from EXCITER unit is fed to the BOOSTER unit and amplified by the driver amplifier Q_{1201} , $2N5590$, and the final amplifier Q_{1202} , $2N5591$, which delivers 10 watts of RF power to the antenna through a two stage, low-pass filter. The DC voltage to Q_{1201} is supplied through the AM modulator Q_7 , $2SD313D$.

The bias voltage is stabilized at 9 volts by a zener diode D_{1209} , $1N4740$. Two diodes D_{1201} and D_{1202} , $10D1$, are used to protect the power transistor from damage due to heating by reducing the bias voltage when the temperature rises. A small portion

of the RF output is rectified by a diode D_{1203} , $1S188FM$, which delivers a resulting DC voltage to the meter where it provides an indication of relative power output from the transceiver.

The DC voltage obtained from rectifying a small portion of the RF output by the ALC diodes D_{1205} and D_{1206} , $1S1555$, which are biased by the ALC threshold control VR_{1201} , is applied to the gate of Q_{906} in the SSB IF unit and Q_{1106} in the MIC AMP unit. This controls their gain in order to automatically control the driving level to the PA transistors in order to prevent any distortion caused by overdrive.

Block diodes D_{1207} and D_{1208} disconnect the supply voltage to Q_{1202} while the antenna is disconnected for marker calibration.

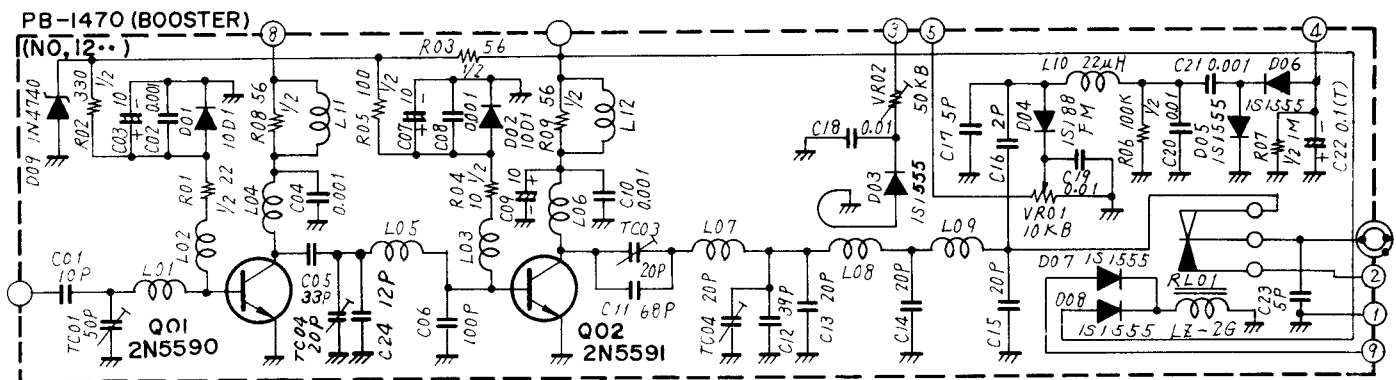

Figure 16

OTHER CIRCUITS

Some circuits work for both transmitting and receiving and are described as follows:

PLL CIRCUIT: VFO unit PB-1465
 FIX unit PB-1453
 LOCAL unit PB-1454
 PLL unit PB-1455

The FT-221R utilizes a phase lock loop system for the heterodyne oscillator providing a stable signal varying from 133.3 through 137.3 MHz to cover the entire 2 meter band.

VFO UNIT (PB-1465)

The VFO module board is installed in the VFO chassis. The VFO (variable frequency oscillator) Q_{1301} , 2SC372Y, generates an 8,000 to 8,500 kHz signal and produces a 500 kHz main tuning dial range. Frequency drift is minimized through the use of a temperature compensation circuit utilizing a differential trimmer capacitor. The signal is fed through the amplifier buffer stage Q_{1302} , 2SK19GR, and Q_{1303} , 2SC372Y, to pin 11 of the FIX oscillator board. The buffer amplifier provides isolation and amplification of the VFO signal.

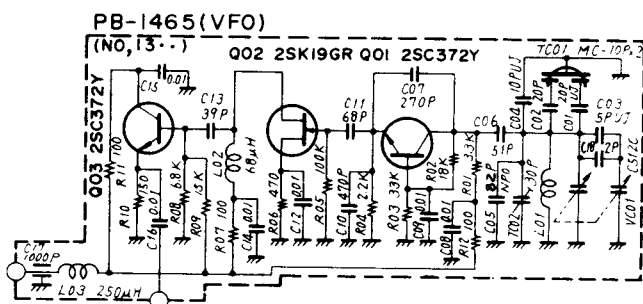

Figure 17

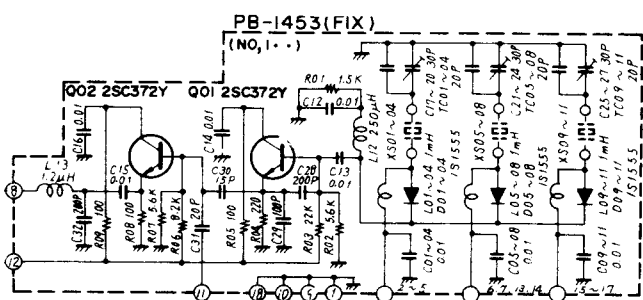

Figure 18

FIX UNIT (PB-1453)

In addition to normal VFO operation, 11 crystals may be selected for crystal controlled operation with the selector switch located on the front panel of the transceiver.

The FIX channel crystal oscillator Q_{101} , 2SC372Y, oscillates at the frequency of the crystal selected by the diode switch D_{101} through D_{111} , 1S1555. The output is fed from pin 8 through the buffer amplifier Q_{102} , 2SC372Y, to the PLL unit.

The signal from the VFO also passes through this buffer stage to the PLL unit.

The crystal frequency falls between 8,000 and 8,500 kHz and is determined as follows.

$$f_x = f_0 - f_1$$

where f_1 is given in Table 1 on page 12 and f_0 is the operating frequency.

LOCAL UNIT (PB-1454)

This oscillator generates a heterodyne signal which is used to convert the VCO (voltage controlled oscillator) signal to an 8,000 to 8,500 kHz signal, which is used for the comparison of the phase with that of the reference (VFO) signal.

The crystal controlled oscillator Q_{201} , 2SC372Y, oscillates at the fundamental frequency of the crystal. A varactor diode D_{226} , 1SV50, connected to the base of Q_{201} , is used as a clarifier to shift the oscillator frequency for receiver off-set tuning.

The output from the oscillator is fed to the frequency multiplier stage, Q_{202} and Q_{203} , 2SC784R, producing the ninth harmonic at its output. The crystal is selected by the diode switch connected to the band switch. The relation between the frequency and band is shown on Table 2. The multiplied signal is then fed from pin 3 to the PLL unit.

For repeater operation, a fundamental crystal at 14.1333 MHz, X210, is used to generate a heterodyne signal of 127.2 MHz which is 600 kHz higher than the normal heterodyne signal when the band switch is set to the 146.5 MHz segment and X211 (fundamental frequency 14.3222 MHz) is used to generate 128.3 MHz signal which is 600

kHz higher than the normal heterodyne signal when the band switch is set to the 147.0 segment. A relay, RL₁₀₀₁ in the tone burst unit is used to select the above crystals with the Repeater switch, S₈, in the ON position. When the Normal-Reverse switch, S₉, is set to the NOR position, the relay selects the repeater crystal on transmit that shifts the transmitting frequency down 600 kHz in the 146.5 MHz segment and shifts up 600 kHz in the 147.0 MHz band. The main VFO tuning dial indicates the received frequency.

With S₉ in the REV position, the relay selects the repeater crystal on receive that shifts the receiver frequency down 600 kHz in the 146.5 MHz segment and shifts up 600 kHz in the 147.0 MHz segment. The main tuning dial now indicates the transmitted frequency.

| BAND | Crystal No. | Crystal Frequency MHz | Local Frequency MHz |
|-------|------------------|--------------------------|------------------------|
| 144.0 | X ₂₀₁ | 13.9222 | 125.3 |
| 144.5 | X ₂₀₂ | 13.9777 | 125.8 |
| 145.0 | X ₂₀₃ | 14.0333 | 126.3 |
| 145.5 | X ₂₀₄ | 14.0888 | 126.8 |
| 146.5 | X ₂₀₆ | 14.2000 | 127.8 |
| | X ₂₁₀ | *14.1333 | 127.2 |
| 147.0 | X ₂₀₇ | 14.2555 | 128.3 |
| | X ₂₁₁ | *14.3222 | 128.9 |
| 147.5 | X ₂₀₈ | 14.3111 | 128.8 |

*Repeater for US Model.

Table 2

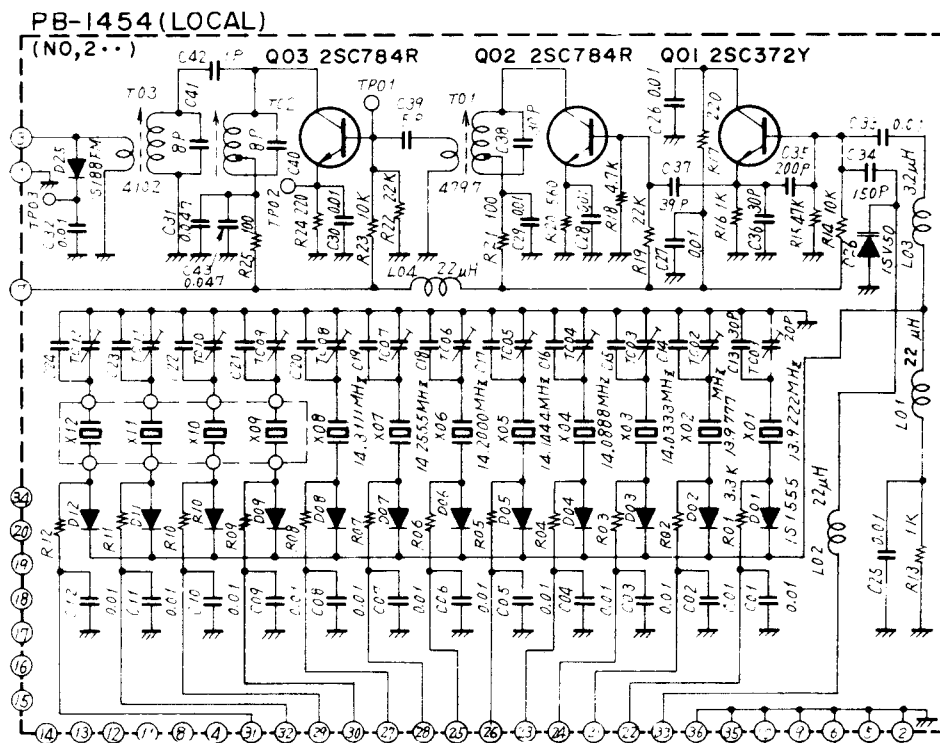

Figure 19

PLL UNIT (PB-1455)

This unit generates a heterodyne signal for the transmitter and receiver mixer in conjunction with the Phase Lock oscillator.

A voltage controlled oscillator Q_{305} , 2SK19GR, generates a signal between 133.3 MHz and 137.3 MHz which is determined by L_{301} , TC_{301} , C_{324} , D_{305} and D_{306} . The varactor diode, D_{305} , changes the frequency by the DC voltage which is delivered from the phase detector amplifier Q_{301} , 2SK19GR. The varactor diode, D_{306} , is used to shift the oscillating frequency in accordance with the band switch setting for a stable lock of the VCO. The output from the VCO, Q_{305} , is fed through a two stage buffer amplifier Q_{306} , 2SK19GR, Q_{307} , 2SC784R, to the mixers, Q_{405} in receive, Q_{501} and Q_{502} in transmit.

A portion of the output from Q_{306} is amplified through the buffer amplifier Q_{304} , 2SC372Y, and is fed to the mixer Q_{303} , 2SC372Y, where the signal from local oscillator unit is converted into a 8,000 to 8,500 kHz comparison signal.

This comparison signal is amplified by the amplifier Q_{302} , $\mu A703HC$ and fed to the phase detector circuit consisting of diodes, D_{303} and D_{304} , 1S-1007.

The phase detector compares the phase of the comparison signal with that of the reference signal which is fed through pin 17 from the FIX unit (VFO or FIX crystal signal), and any phase difference is converted into an error correcting voltage. This error voltage is amplified by Q_{301} , 2SK19GR, and fed to the varactor diode D_{305} , 1SV50, which changes the output signal phase to track the input.

The programmable unijunction transistor D_{301} , N13T1, generates a sawtooth wave when the VCO is unlocked. The sawtooth wave is used to lock the VCO. A portion of it is fed to the inverter Q_{308} , and rectified by Q_{310} 1S1555.

The rectified voltage causes Q_{309} , 2SC372Y, to conduct and its emitter voltage is used to conduct Q_{607} in the AF unit thus shorting the audio input to quiet the receiver when the PLL is unlocked.

In transmit, this voltage controls Q_{507} in the EXCITER unit causing Q_{506} cut off to disable the exciter stages. Thus, the transmitter and receiver stop functioning when the VCO is unlocked. With this voltage, a multivibrator Q_{308} , TP4011AN, produces a blanking pulse which controls the pilot lamp driver Q_{310} , MPSA13, causing the pilot lamp to flicker indicating VCO unlock.

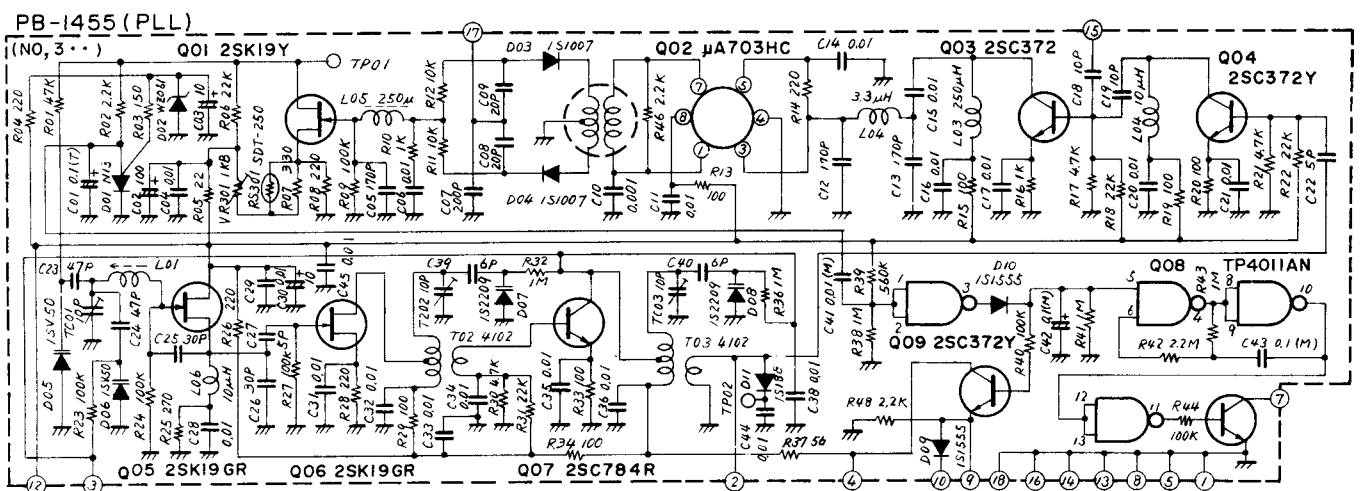

Figure 20

MARKER UNIT (PB-1459)

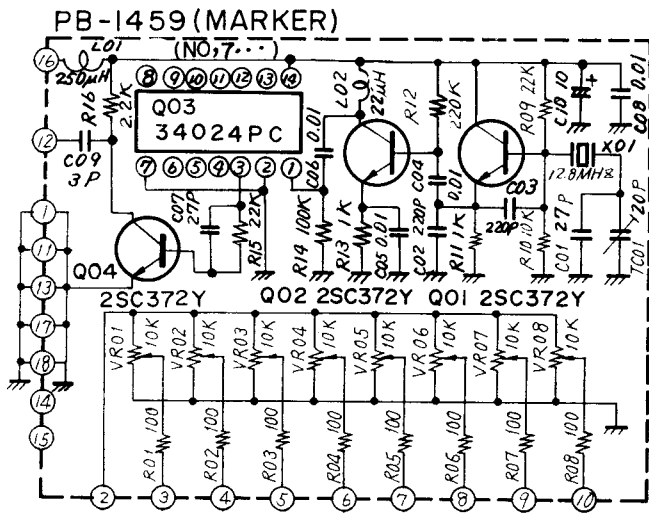

Figure 21

The crystal marker generator Q_{701} , 2SC372Y, generates a 12.8 MHz signal, and its output is fed through the buffer amplifier Q_{702} , 2SC372Y, to the frequency divider Q_{703} , 34024PC, where the 12.8 MHz signal generates a 100 kHz marker signal. The marker signal is fed through a buffer amplifier Q_{704} , 2SC372Y to the RX RF unit. When the marker switch is ON, the antenna relay is activated to disconnect the antenna.

Potentiometers VR_1 through VR_8 are installed in this board. These potentiometers are set to change the tuning frequency of the VCO and the exciter tuning circuits.

TONE BURST UNIT (PB-1461)

The tone burst signal is automatically transmitted in the following manner. When the PTT switch of the microphone is pressed momentarily before a normal transmission, the rapid voltage change in the PTT circuit causes a pulse to be fed to the tone burst control circuit consisting of Q_{1001} , Q_{1002} , Q_{1003} , TP4011AN, and Q_{1004} , TP4049AN, thus activating the tone burst oscillator Q_{1003} , TP4011AN.

Normal push-to-talk operation does not produce a pulse to activate the tone burst oscillator.

The tone frequency may be adjusted to any frequency between 1000 to 2000 Hz with VR_{1002} and the tone burst duration may be adjusted with VR_{1001} . The tone signal output level may be adjusted with VR_{1003} . The output from the tone burst oscillator is fed through the buffer Q_{1006} , 2SK19GR, to pin 29 in the MIC AMP unit.

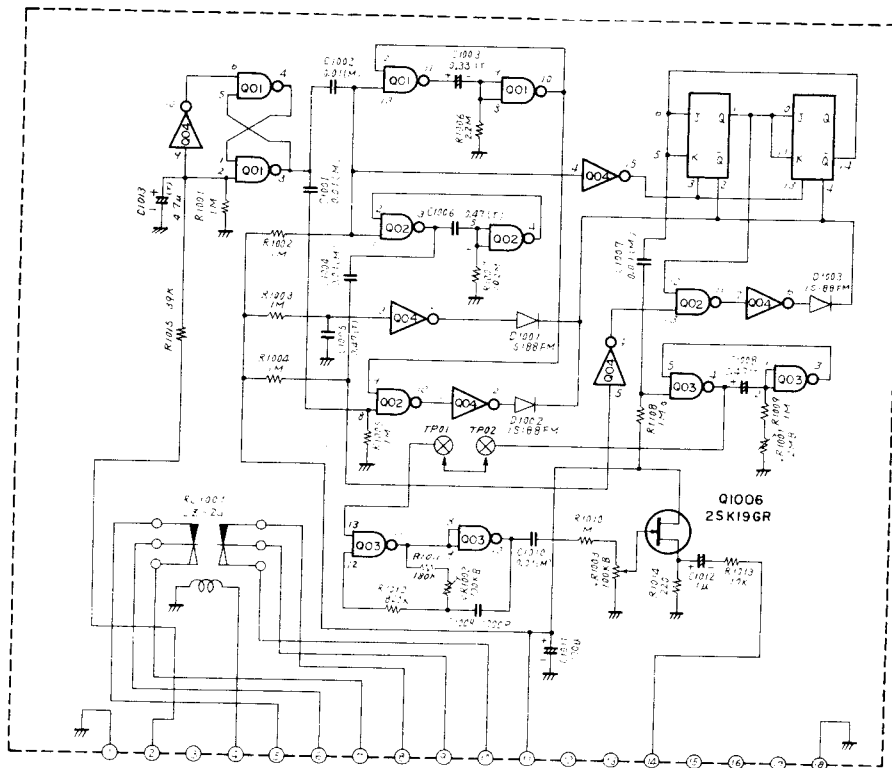

POWER SUPPLY & REGULATOR UNIT (PB-1469)

The power supply has been designed to operate from 100/110/117/200/220 or 234 volts AC 50/60 Hz, or 12 volts DC, negative ground. Inserting the appropriate power plug into the rear panel receptacle makes the necessary connections to operate the supply in either mode, AC or DC.

For AC operation, the DC voltage is supplied from the bridge connected rectifier unit D₁₅₀, M4B-5, which is connected to a 20 volt, 3.5 amps secondary winding of the power transformer. The DC voltage is regulated at 13.5 volts by the voltage regulator circuit consisting of Q₁₅₀₁, 2SD313D, and Q₁, 2SD114.

Since such circuits as the VFO, local oscillator PLL circuit, require an extremely stabilized voltage, the 13.5 volts DC voltage is further stabilized at 8 volts by the voltage regulator Q₁₅₀₃, 2SC735Y, Q₁₅₀₄, 2SD313D, and Q₁₅₀₅, 2SC372Y.

For DC operation, the positive voltage is connected to pin 3 and the negative voltage to pin 4, of the power receptacle, J₁. To protect the circuits from any reverse connection of the DC voltage, D₁, DS130YD, conducts heavily in the reverse polarity connection to blow the line fuse in the DC cord. It is placed between pin 3 and ground on J₁.

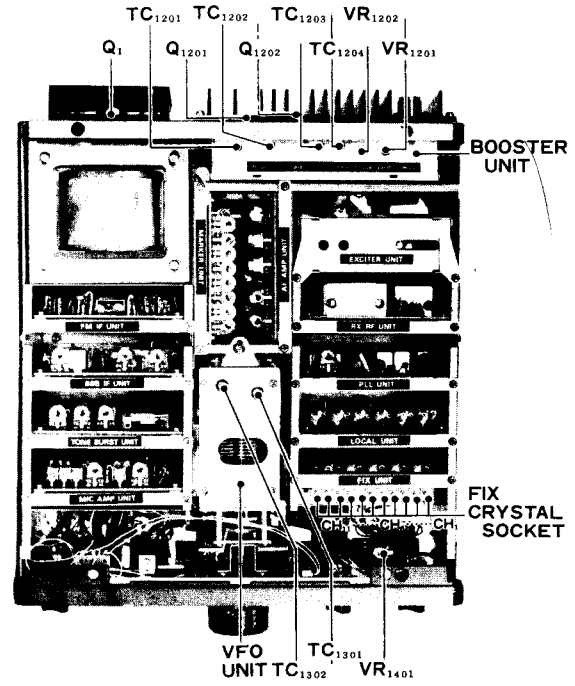

TOP VIEW

Figure 24

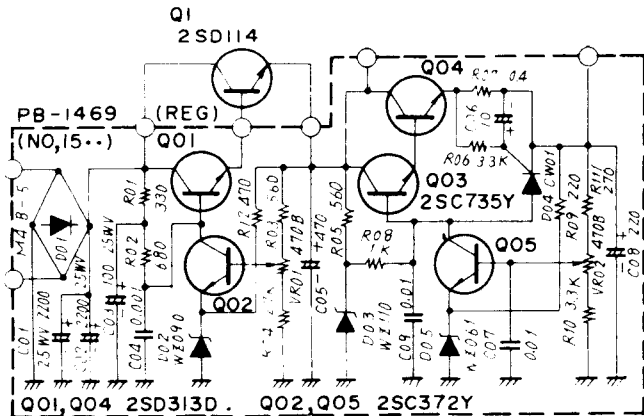
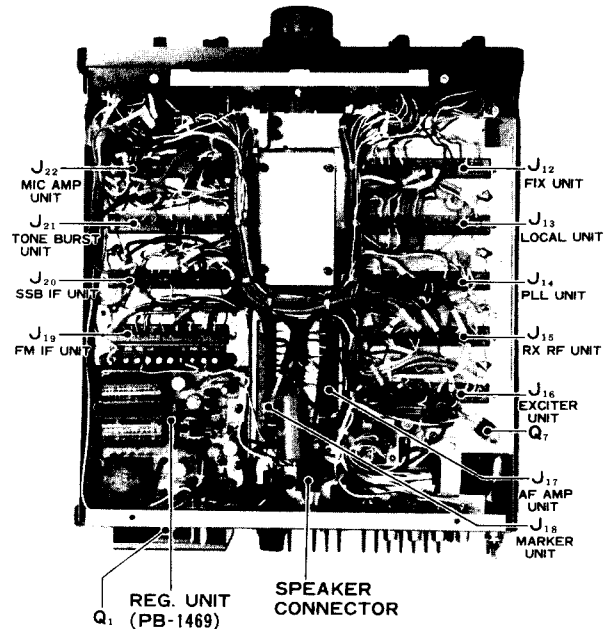

Figure 23



BOTTOM VIEW

Figure 25

MAINTENANCE & ALIGNMENT

GENERAL

Your model FT-221R transceiver has been carefully aligned and tested at factory prior to shipment. The reliability of the solid-state devices used in the FT-221R should provide years of trouble free service if the transceiver is not abused and normal, routine maintenance is carried out.

The following precautions should be observed to prevent damage to the transceiver:

- (1) Do not interchange the AC and DC power cords.
- (2) Do not apply any AC voltage other than the voltage determined by the transformer wiring.
- (3) Do not exceed 14 volts DC, at the POWER receptacle, on DC operation. When operating mobile, check the battery voltage under the load (transmitter "keyed" in FM mode) with the engine running fast enough so the ammeter shows a "charge". In addition, do not operate the FT-221R if the supply voltage is below 12 volts DC.
- (4) Avoid direct exposure to sunshine or water.

ROUTINE MAINTENANCE

Routine maintenance should be limited to keeping the transceiver clean, and periodic performance checks of the transmitter RF power output and the receiver sensitivity.

Cleaning:

When the transceiver has been used in dusty or sandy areas, the interior should be periodically cleaned. A vacuum-cleaner, or low pressure air source should be used, while any accumulated dirt may be removed with a soft brush. Check that the interior is thoroughly dry before replacing the case and/or operating the equipment. Wipe the exterior with a damp cloth whenever required.

PERFORMANCE CHECKS

Make all performance checks at 13.5 volts DC (under load) or AC with the appropriate voltage as determined by the transformer wiring.

Check the transmitter output as follows:

- (a) Connect a suitable 50 ohm dummy load/RF wattmeter to the ANT receptacle.
- (b) Set the MODE switch to FM and key the transmitter while observing the power output. The power should be approximately 10 watts, and the S-meter should read between 6 and 8.
- (c) Set the MODE switch to SSB and key the transmitter. Speak normally into the microphone. The output meter should show 3 to 5 watts mean value.

Check the receiver sensitivity as follows:

- (a) Connect an AC VTVM to the SP receptacle, set the MODE switch to FM and set the SQUELCH control fully counter-clockwise.
- (b) Connect the RF output of a precision, VHF signal generator to the ANT receptacle and with no signal input note the VTVM reading. Adjust the VOLUME control and VTVM range, as required, to obtain an approximate full scale reading. (DO NOT change the VOLUME control setting after this adjustment is made.)
- (c) Set the signal generator to the receiving frequency of the transceiver and adjust the output amplitude of the signal generator until the VTVM reads 1/10th (20 dB decrease) of the reading in step (b). The signal generator output voltage at this point is the 20 dB quieting sensitivity, and should be approximately 0.3 μ V.
- (d) Set the MODE switch to SSB position and connect the AC VTVM to the speaker output. Apply an unmodulated, 0.5 μ V signal, from the standard signal generator and tune the transceiver for a maximum VTVM reading.
- (e) Set the RF GAIN control to the fully clockwise position and adjust the AF GAIN control for a 450 mV VTVM reading.
- (f) Reduce the signal generator output and read the VTVM reading. The VTVM reading should be less than 45 mV for a 10 dB S/N ratio.

If the above performance checks indicate a need for realignment it is recommended that the transceiver be returned to the dealer for alignment. The alignment procedures require special test equipment and techniques not normally available to the average owner. Attempts to realign the tuned

circuits without proper test equipment will result in degraded performance of the transceiver.

ALIGNMENT

SOME OF THE FOLLOWING ALIGNMENT PROCEDURES REQUIRE SPECIAL TEST EQUIPMENT AND TECHNIQUES AND SHOULD ONLY BE DONE BY AN EXPERT TECHNICIAN.

AF AMP UNIT

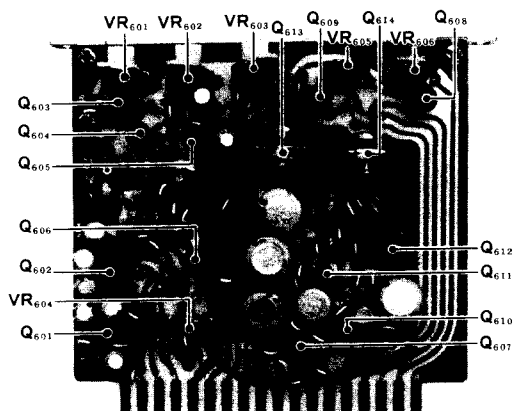

Figure 26

(1) CW Break-In

Adjust VR₆₀₁, DELAY control, for a suitable release time.

(2) CW Sidetone Level

Adjust VR₆₀₄ for a suitable side tone level.

(3) Relay Sensitivity & Antitrip

Set the controls as follows:

- VR₆₀₂ RELAY Fully CCW
- MIC GAIN Fully CCW
- VOX GAIN PTT
- MODE LSB or USB

Slowly rotate the RELAY control, VR₆₀₂, until the relay activates, then return the control carefully counter clockwise until the relay releases. This release point is the proper setting for the RELAY sensitivity control. Set the MIC GAIN control to the 2 o'clock position and the VOX control on the front panel to the 12 o'clock position. Speaking normally into the microphone, make sure that your voice activates the relay. Tune in a signal and adjust the AF GAIN on the front panel to a comfortable listening level. Set the ANTITRIP

control, VR₆₀₃, to the minimum point that will prevent the speaker output from tripping the VOX. Adjust the DELAY control, VR₆₀₁, for a suitable relay release time.

(4) Discriminator Meter Center

Set the controls as follows:

- CHANNEL . . . VFO
- MODE FM
- DISC OFF (down position)
- RF GAIN . . . Fully CW
- MARKER . . . ON (up position)

Tune the transceiver for maximum S-meter reading at a marker signal. This maximum reading has a 3 kHz width and the VFO should be set to the center of the signal. Turn the DISC switch on and adjust the center potentiometer, VR₆₀₅, until the meter indicates mid point on the scale. Check that the meter moves equally toward both ends when the VFO frequency is shifted equally up or down. Shift the VFO frequency 10 kHz lower than the zero center meter indication, and adjust the DISC potentiometer, VR₆₀₆, until the meter indicates 2.

MARKER UNIT

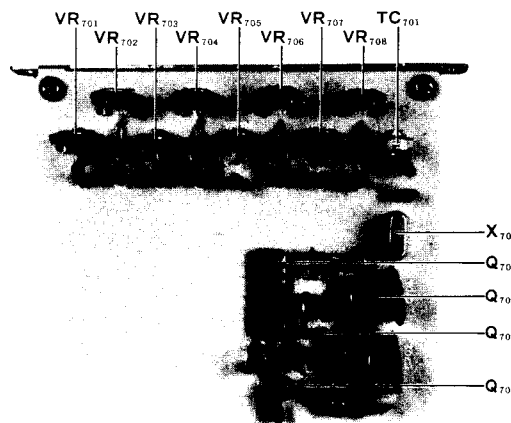

MARKER UNIT (PB-1459)

Figure 27

(1) Frequency Adjustment

Connect a frequency counter, through a 100 PF capacitor, to the collector of Q₇₀₂, 2SC372Y. Adjust TC₇₀₁ to set the crystal frequency to 12.8MHz.

When the counter is not available, use another H.F. receiver and calibrate the 100kHz signal against WWV or JJY.

(2) Voltage Adjustment for the Varicap Tuning Circuit

Measure the voltage at pins 3, 4, 5, 6, 7, 8, 9 and 10 with a VTVM connected between the pins and ground.

Adjust the appropriate potentiometer, VR₇₀₁ to VR₇₀₈, for following pin voltages:

| Pin No. | 3 | 4 | 5 | 6 | 7 | 8 | 9 | 10 |
|----------------|-----|-----|-----|-----|-----|-----|-----|-----|
| Adjust. VR No. | 701 | 702 | 703 | 704 | 705 | 706 | 707 | 708 |
| Volt. DC. V. | 2.0 | 2.5 | 3.0 | 3.5 | 4.0 | 4.5 | 5.0 | 5.5 |

Table 3

(2) Carrier Balance (SSB Receive)

Disconnect the antenna.

Set the MODE switch to either the LSB or USB modes, and the RF GAIN control fully counter clockwise. Adjust VR₉₀₁ and TC₉₀₁ (CARRIER BALANCE) alternately until the S-meter indicates full scale. Change the MODE switch to CW position and check if the S-meter indicates exactly full scale.

MIC AMP UNIT

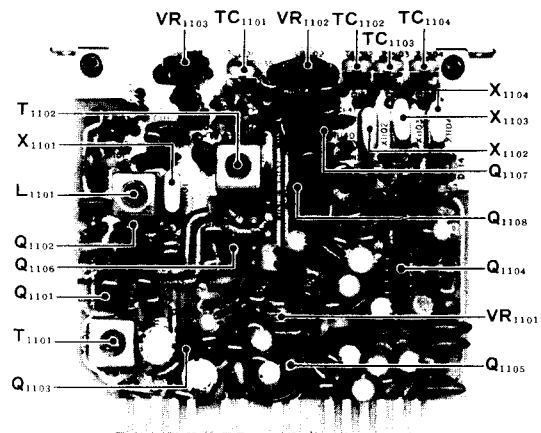

Figure 29

SSB IF UNIT

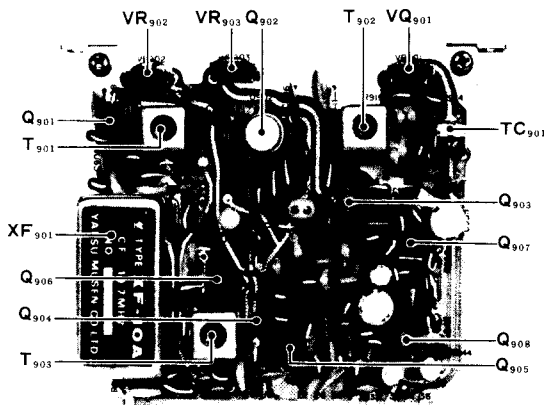

Figure 28

(1) S Meter Setting

Disconnect the antenna from the coax receptacle. Set the MODE switch to the AM mode. Set the RF GAIN control on the front panel to the fully clockwise position. Adjust VR₉₁₃ (ZERO) until the meter indicates zero. Then set the RF GAIN control to the fully counter clockwise position. Adjust VR₉₀₂ (FULL SCALE) until the meter indicates full scale. Repeat above procedures until the meter indicates zero and full scale with above mentioned RF GAIN settings.

(1) SSB Carrier Frequency

Connect a dummy load, such as the YAESU YP-150, to the antenna receptacle and the output of an audio oscillator to the microphone input. Set the MODE switch to an SSB mode. Apply 1 kHz audio signal to the microphone input and adjust the MIC GAIN control or the output level from the audio oscillator for 10 watts RF output on the dummy load. Change the audio frequency to 350 Hz, and adjust TC₁₁₀₂ for LSB and TC₁₁₀₃ for USB to obtain 2.5 watts output. Check if the power output decreases to 2.5 watts when the audio frequency is moved to approximately 2600 Hz.

(2) AM and CW Carrier Frequency

Tune the transceiver in the USB mode and monitor the transmitted USB signal for the most natural voice quality while using another receiver. Change the mode of the transceiver to AM (with the monitor receiver in the USB mode), and adjust TC₁₁₀₄ for a zero beat against a carrier signal.

(3) Carrier Balance (SSB Transmit)

Connect a dummy load to the antenna receptacle and the RF probe of a VTVM to the inner conductor of coax cable at the antenna receptacle. Set the MODE switch to the LSB mode. Set the MIC GAIN control to the fully CCW position. Set the VOX switch to MOX position. Adjust VR₁₁₀₂ and TC₁₁₀₁ (CARRIER BALANCE) alternately to minimize the VTVM reading.

Repeat this procedure until a minimum reading is obtained equally for both side bands.

(4) CW Carrier Level

Set the CW level control, VR₁₁₀₅, to the point where the output power starts to saturate.

FIX UNIT

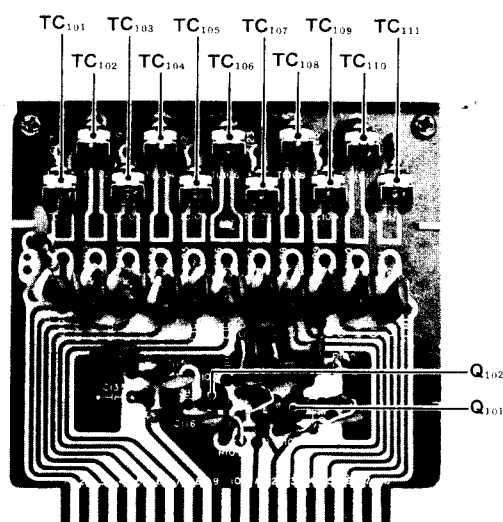

Figure 30

The crystal frequency may be precisely adjusted with TC₁₀₁ to TC₁₁₁ for on-frequency crystal controlled operation.

LOCAL UNIT

Set the MODE switch to USB, the BAND switch to 144.0, the CHANNEL switch to VFO, the MARK switch to OFF and the RPT switch to the OFF position. Connect a frequency counter to TP₂₀₁ and adjust the oscillator frequency to 41.7666 MHz with TC₂₀₁. Set the MARK switch to the ON position and zero beat against the marker signal at 144.0 MHz on the VFO tuning

dial. Set the BAND switch to 144.5 MHz and adjust TC₂₀₂ to zero beat, then adjust TC₂₀₃ for 145.0 MHz, TC₂₀₄ for 145.5 MHz, TC₂₀₅ for 146.0 MHz, TC₂₀₆ for 146.5 MHz, TC₂₀₇ for 147.0 MHz and TC₂₀₈ for 147.5 MHz for a zero beat against the marker signal.

For the U.S. model, set the RPT switch to REV, the AUX/600 kHz switch to 600 kHz and the BAND switch to 146.5. Adjust TC₂₁₀ for zero beat. Change the BAND switch to 147.0 and adjust TC₂₁₁ for zero beat. For the European model, set the BAND switch to 145.0 and adjust TC₂₁₀ for zero beat. During the above repeater frequency adjustment, the VFO dial is set to the zero beat obtained in the preceding adjustment.

For the frequency split other than 600 kHz, the crystal calculated by the formula in page 12 is installed in X₂₀₉ socket for 146.5 MHz band and in X₂₁₂ socket for 147.0 MHz band. Set the AUX/600 kHz switch to AUX position.

For the split frequency in 100 kHz order, such as 800, 900 or 1000 kHz, use the internal marker signal to calibrate as described in 600 kHz procedures. Adjust TC₂₀₉ for zero beat on 146.5 MHz band and TC₂₁₂ on 147.0 MHz band.

When the split frequency is not in 100 kHz order, such as 850 kHz or 940 kHz, the internal marker signal can not be used. In such a case, connect a precise frequency counter between TP₂₀₁ and ground and adjust TC₂₀₉ or TC₂₁₂ for exact frequency which is 3rd harmonics of the crystal frequency given from the formula. For example, the counter frequency should be 42.31666 MHz for 850 kHz split on 146.5 MHz band, as the crystal frequency is $(127.8 - 0.85) \div 9 = 14.1055$ MHz.

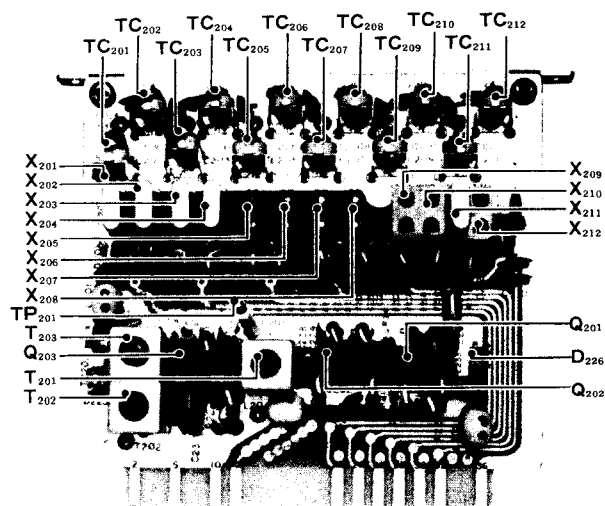

Figure 31

PLL UNIT

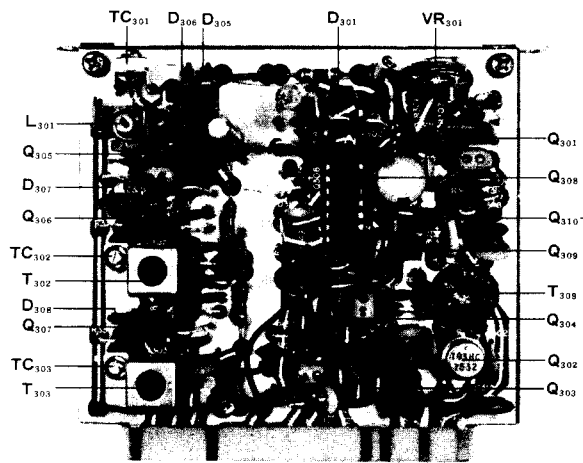

Figure 32

This unit does not require any adjustment unless major components are changed, and, as such, requires precise measuring equipment for alignment. When the PLL circuit is unlocked, the pilot lamps start flickering. Adjust VR₃₀₁ until the circuit locks and the pilot lamps stop flickering. Check that the circuit locks at all segments and entire VFO range.

RX RF UNIT

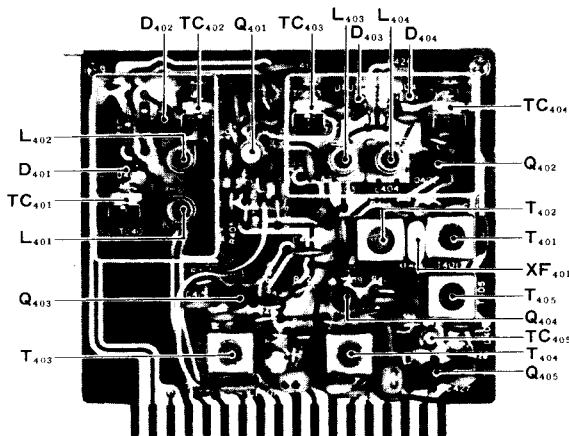

Figure 33

Set the BAND switch to 144.0, the CHANNEL switch to VFO, the RF GAIN control fully clockwise and the MODE switch to the USB mode. Tune the VFO to a signal (144.20 MHz, 10dB) from a signal generator connected to the antenna receptacle. Peak TC₄₀₁, TC₄₀₂, TC₄₀₃ and TC₄₀₄ for a maximum S-meter reading. In areas that use the high side of the band, 146 to 148 MHz, it is recommended to perform above procedures on 146.20 MHz.

EXCITER UNIT/BOOSTER UNIT

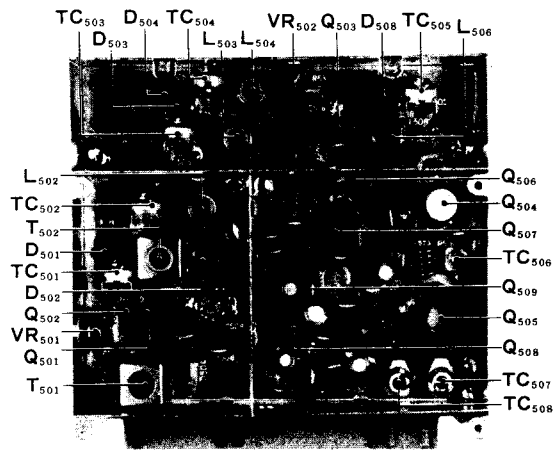

Figure 34

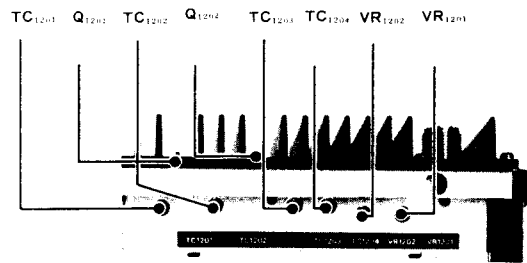

Figure 35

(1) Power Output

It is recommended that an insulated wand be used for the alignment of the booster unit. Connect a dummy load to the antenna receptacle. Set the BAND switch to 145.0, the CHANNEL switch to VFO and the MODE switch to FM. Set the VFO to 145.0 MHz. Set the VOX control to the MOX position. Peak TC₅₀₁ through TC₅₀₈ and TC₁₂₀₁ through TC₁₂₀₄ for maximum power output.

Change the frequency to 144.1 MHz and repeat above procedures for maximum power output. Change the frequency to 147.9 MHz and repeat above procedures for maximum power output.

Repeat the procedures alternately on 144.1 MHz, 145.0 MHz and 147.9 MHz until unity power output is obtained over 144 to 148 MHz.

(2) PO Meter Set

The PO (Power Output) meter indicates relative power output. After the completion of the above power output alignment, set the meter control, VR₁₂₀₂, to the point where the meter indicates 80% of full scale.

(3) AM Carrier Level

Set the MODE switch to the AM position. Adjust VR₅₀₂, in the EXCITER UNIT, for 2.5 watts unmodulated carrier output on the dummy load.

(4) ALC Threshold

Connect the output from a two-tone signal generator to the microphone input and dummy load to the antenna receptacle. Set the BAND switch to 145.0, the CHANNEL switch to VFO, the MODE to USB and the MIC GAIN to the 12 o'clock position. Set the VOX GAIN control to the MOX position. Apply a 1 kHz single tone signal at first and adjust the signal generator output until the power meter shows 2.5 watts. Then apply a 1.5 kHz single tone signal and adjust its output for 2.5 watts output. Then leave the output levels of both tones at the set level and apply a 1 kHz/1500 kHz, two tone signal, of the above set level. Adjust VR₁₂₀₁ until the power meter indicates 3 watts.

SQUELCH THRESHOLD

Disconnect the antenna. Set the BAND switch to 144.0, the CHANNEL switch to VFO, the RF GAIN to the fully CW position, the MODE switch to FM and SQUELCH control to the 9 o'clock position. Adjust VR₁₄₀₁ to the point where the receiver is just silenced. Do not go beyond this threshold point or the SQUELCH control on the front panel will not function properly.

FM DEVIATION ADJUSTMENT

Connect a dummy load and FM deviation meter to the antenna receptacle. Set the MODE switch to FM and the MIC GAIN control to the 2 o'clock position. Apply a 20 mV, 1 kHz audio signal to the microphone input, and set the VOX control to the MOX position. Adjust VR₁₁₀₁ in the MIC AMP UNIT for a deviation of ± 5 kHz.

TONE BURST UNIT

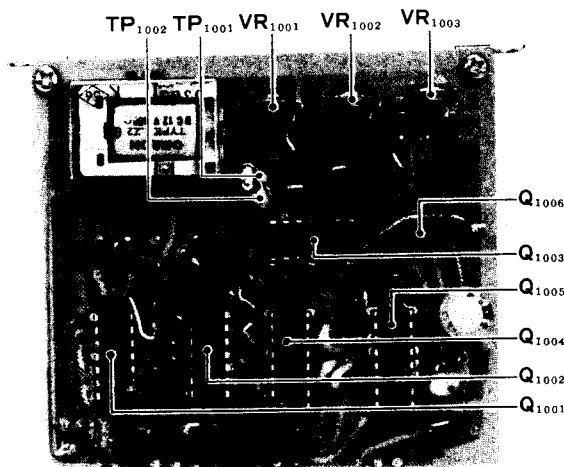

Figure 36

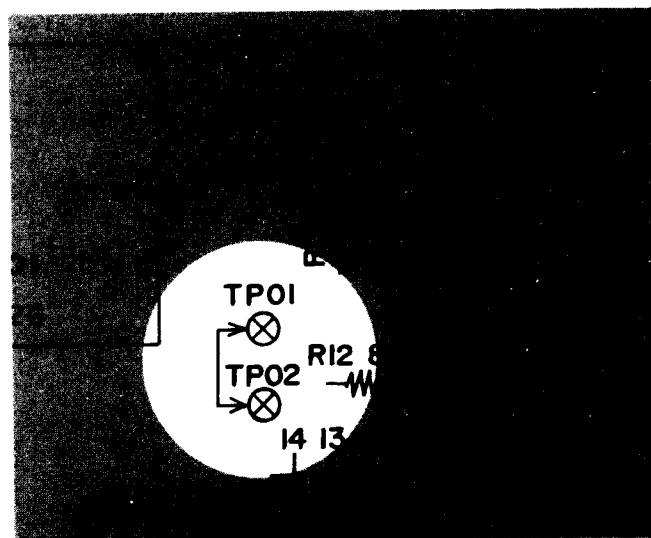

Figure 37

The adjustment of this unit should be done after the above FM deviation alignment has been completed. Set the controls, switches and the deviation meter as described in the deviation adjustment. Remove the tone burst unit from the chassis and disconnect the connection of the two test points as illustrated in order to obtain a continuous tone signal during the alignment. Insert the unit into its socket.

Set the MIC GAIN control to the 2 o'clock position and the VOX GAIN control to the MOX position. Measure the burst tone signal frequency at the deviation meter output. Adjust VR₁₀₀₂ to the desired frequency. Adjust VR₁₀₀₃ for ± 3.5 kHz deviation.

Set the VOX GAIN control to the PTT position and remove the unit from its socket. Reconnect the disconnected test points and reinstall it into its socket.

The burst signal is automatically transmitted when the PTT switch on the microphone is keyed twice as, i.e., key 0.5 second, receive 0.5 second and then transmit. The deviation of the burst signal is preset at the factory to approximately 0.5 second. It may be adjusted with VR₁₀₀₁. A clockwise rotation produces a longer deviation.

FM IF UNIT

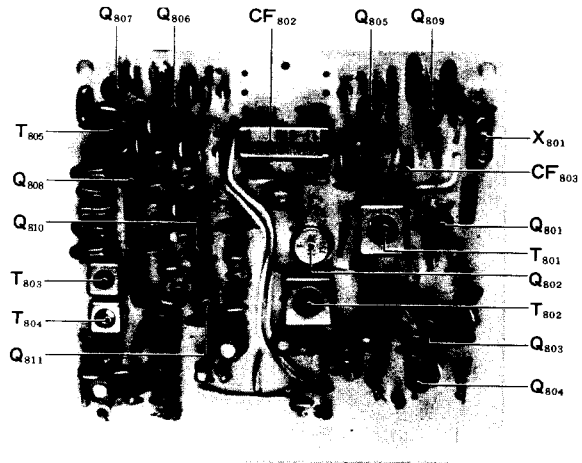

Figure 39

REGULATOR UNIT

Use an AC supply for this alignment. Connect a VTVM DC probe to the 13.5 volt line of the power supply unit. Adjust VR₁₅₀ for a 13.5 volt VTVM reading. Connect the VTVM to the 8 volt line and adjust VR₁₅₀₂ for a 8 volt VTVM reading.

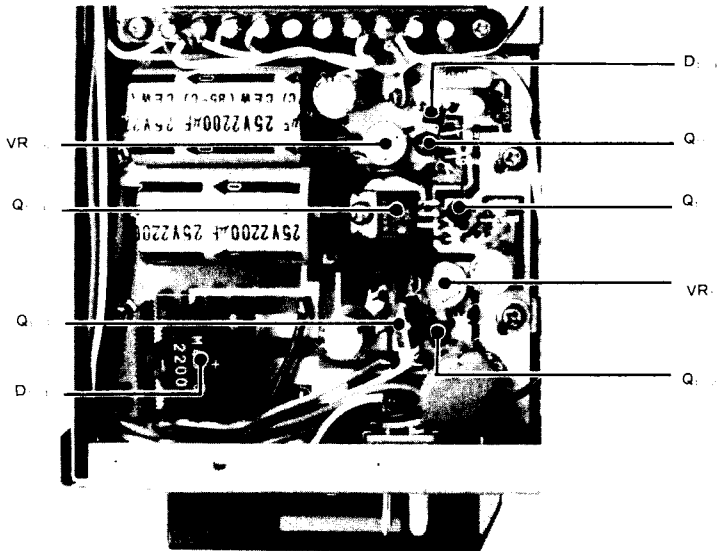

Figure 38

CONNECTOR RESISTANCE CHART

| UNIT PIN | FIX | LOCAL | PLL | RX RF | EXCITER | AF AMP | MARKER | FMIF | SSB IF | TONE BURST | MIC AMP |
|-------------|-----------------|-----------------|-----------------|-----------------|-----------------|-----------------|-----------------|-----------------|-----------------|-----------------|-----------------|
| | J ₁₂ | J ₁₃ | J ₁₄ | J ₁₅ | J ₁₆ | J ₁₇ | J ₁₈ | J ₁₉ | J ₂₀ | J ₂₁ | J ₂₂ |
| 1 | E | E | E | E | E | E | E | E | E | E | E |
| 2 | ∞ | E | O | 2.6 K | 250 | 0 | 53* | 5.5 K | E | 1.7 K | E |
| 3 | ∞ | O | 2.3 K | — | 250 | 53* | 2.4 K | E | 3.5 K | — | 6K |
| 4 | ∞ | — | 53* | E | O | 74* | 2.5 K | 500 | — | 450 | 3.2K |
| 5 | ∞ | E | E | O | 6K | — | 2.5 K | 10 | 700 | 53 | 300 |
| 6 | ∞ | E | 45* | ∞ | E | ∞ | 3 K | 1 K | — | 53 | E |
| 7 | ∞ | 53 | 160* | O | E | 0 | 3 K | 300 | 250 | ∞ | E |
| 8 | ∞ | — | E | E | 2.4 K | 0 | 3 K | 1.6 K | — | 2.4 K | O |
| 9 | E | E | 2 K | 0 | 2 K | 40* | 2.7 K | E | 53* | 2.4 K | 12K |
| 10 | E | E | 160* | E | 2.6 K | E | 2.3 K | 2.5 K | — | ∞ | 700 |
| 11 | ∞ | — | — | 53* | 2.6 K | — | E | E | E | 350 | E |
| 12 | 53* | — | 53* | E | 100K | 1.6K | ∞ | — | — | — | E |
| 13 | ∞ | — | E | 2.4 K | 1.1 K | 850 | E | 53* | 700K | — | E |
| 14 | ∞ | — | E | 3.5 K | E | 1 K | — | 3.3 K | — | 850 | 700K |
| 15 | ∞ | — | O | 3.3 K | E | 2.1 K | — | 100 K | 250 | — | 250 |
| 16 | ∞ | — | — | E | E | 1.5 K | 2.4 K | E | 500 | — | 250 |
| 17 | ∞ | — | ∞ | 0 | ∞ | 5.5K | E | 0 | 2.6 K | — | E |
| 18 | E | — | E | E | E | E | E | E | 46* | E | E |
| 19 | | — | | | | | | | — | | E |
| 20 | | — | | | | | | | — | | 650 |
| 21 | | ∞ | | | | | | | 300 | | 53* |
| 22 | | 54* | | | | | | | — | | 500 |
| 23 | | — | | | | | | | 400 | | E |
| 24 | | — | | | | | | | 400 | | E |
| 25 | | — | | | | | | | ∞ | | 9K |
| 26 | | — | | | | | | | — | | O |
| 27 | | — | | | | | | | 53* | | 9 K |
| 28 | | — | | | | | | | 500 | | ∞ |
| 29 | | — | | | | | | | 4.5 K | | 850 |
| 30 | | — | | | | | | | E | | 2.2K |
| 31 | | — | | | | | | | E | | ∞ |
| 32 | | — | | | | | | | 500 | | 5K |
| 33 | | 17K | | | | | | | 1.9K | | ∞ |
| 34 | | — | | | | | | | E | | 1K |
| 35 | | E | | | | | | | E | | E |
| 36 | | E | | | | | | | E | | E |

Switch, Knob Position

POWER...OFF MODE...FM BAND...144.0 CHANNEL...VFO RF GAIN...MAX VOX GAIN...PTT

AF GAIN }
MIC GAIN } ...CENTER
SQUELCH }

FUNCTION SW...OFF

Measured with 20KΩ/V

Values are in OHMS

VOLTAGE CHART

FIX Unit

| | E | B | C | | E | B | C |
|------|-----|-----|-----|------|-----|-----|-----|
| Q101 | 0.9 | 1.4 | 7.7 | Q102 | 2.2 | 2.9 | 5.8 |

LOCAL Unit

| | E | B | C | | E | B | C | | E | B | C |
|------|-----|-----|-----|------|-----|-----|-----|------|-----|-----|-----|
| Q201 | 2.4 | 2.5 | 7.6 | Q202 | 1.1 | 1.3 | 7.9 | Q203 | 0.9 | 1.4 | 7.6 |

PLL Unit

| | E(S) | B(G) | C(D) | | E(S) | B(G) | C(D) | | E(S) | B(G) | C(D) |
|------|------|------|------|------|------|------|------|------|------|------|------|
| Q301 | 1.6 | 0 | 4.5 | Q305 | 0.9 | 0 | 5.4 | Q309 | 0 | 0 | 8.0 |
| Q303 | 0.9 | 1.4 | 8.0 | Q306 | 1.0 | 0 | 5.9 | Q310 | 0 | 0.7 | 1.3 |
| Q304 | 0.5 | 1.1 | 7.5 | Q307 | 0.5 | 0.8 | 7.2 | | | | |

| | 1 | 2 | 3 | 4 | 5 | 6 | 7 | 8 | 9 | 10 | 11 | 12 | 13 | 14 |
|------|-----|-----|-----|-----|-----|-----|-----|-----|-----|----|-----|----|----|-----|
| Q302 | 7.2 | — | 1.5 | E | 1.5 | — | 7.2 | 7.5 | | | | | | |
| Q308 | 4.9 | 4.9 | 0.2 | 8.0 | 0 | 1.9 | E | 8.0 | 8.0 | 0 | 8.0 | 0 | 0 | 8.0 |

RX RF Unit

| | E (S) | | B (G) | | C (D) | | G ₂ | | | E (S) | | B (G) | | C (D) | |
|------|-------|-----|-------|---|-------|-----|----------------|---|------|-------|---|-------|---|-------|-----|
| | R | T | R | T | R | T | R | T | | R | T | R | T | R | T |
| Q401 | 1.5 | 0 | 1.6 | 0 | 8.0 | 0.1 | 3.9 | 0 | Q404 | 0.7 | 0 | 1.4 | 0 | 7.9 | 0.1 |
| Q402 | 1.6 | 1.1 | 0 | 0 | 7.9 | 0.1 | | | Q405 | 1.0 | 0 | 0 | 0 | 7.7 | 0 |
| Q403 | 1.2 | 0 | 1.8 | 0 | 7.8 | 0.1 | | | | | | | | | |

EXCITER Unit (on Transmit)

| | LSB.USB.CW | | | AM.FM | | | | LSB.USB.CW | | | AM.FM | | | | LSB.USB.CW | | | AM.FM | | |
|------|------------|------|------|-------|------|------|------|------------|------|------|-------|------|------|------|------------|------|------|-------|------|------|
| | E(S) | B(G) | C(D) | E(S) | B(G) | C(D) | | E(S) | B(G) | C(D) | E(S) | B(G) | C(D) | | E(S) | B(G) | C(D) | E(S) | B(G) | C(D) |
| Q501 | 1.3 | 0 | 12.1 | 1.4 | 0 | 11.8 | Q504 | 0.4 | 1.2 | 10.1 | 0.4 | 1.2 | 10.0 | Q507 | 0 | 0 | 13.3 | 0 | 0 | 13.3 |
| Q502 | 1.3 | 0 | 12.1 | 1.4 | 0 | 11.7 | Q505 | 0 | 0.7 | 13.4 | 0 | 0.7 | 13.4 | Q508 | 1.1 | 1.8 | 5.4 | 1.1 | 1.8 | 5.4 |
| Q503 | 1.2 | 1.9 | 12.0 | 1.2 | 1.9 | 11.9 | Q506 | 12.5 | 13.3 | 13.5 | 12.5 | 13.3 | 13.5 | Q509 | 4.9 | 5.5 | 13.5 | 4.9 | 5.5 | 13.5 |

Receive.....0V

AF AMP Unit

| | LSB.USB.CW AM | | | FM | | | | LSB.USB.CW AM | | | FM | | | | LSB.USB.CW AM | | | FM | | |
|------|------------------|------|------|------|------|------|------|------------------|------|------|------------------|------|------------------|------|------------------|------|------|------|------|------|
| | E(S) | B(G) | C(D) | E(S) | B(G) | C(D) | | E(S) | B(G) | C(D) | E(S) | B(G) | C(D) | | E(S) | B(G) | C(D) | E(S) | B(G) | C(D) |
| Q601 | 0.4 | 1.0 | 7.0 | 0.4 | 1.0 | 7.0 | Q607 | 0 | 0 | 0.6 | 0 | 0 | 0.6 | Q612 | 13.5 | 12.9 | 7.5 | 13.5 | 12.9 | 7.5 |
| Q603 | 0.4 | 0 | 0.6 | 0.4 | 0 | 0.6 | Q608 | 0 | 0 | 0 | 1.9 [★] | 0 | 5.7 [★] | Q613 | 6.8 | 7.4 | 13.5 | 6.8 | 7.4 | 13.5 |
| Q604 | 0 | 0.6 | 12.9 | 0 | 0.6 | 12.9 | Q609 | 0 | 0 | 0 | 2.6 [★] | 0 | 6.3 [★] | Q614 | 6.8 | 6.2 | 0 | 6.8 | 6.2 | 0 |
| Q605 | 0.4 | 1.0 | 5.8 | 0.4 | 1.0 | 5.8 | Q610 | 0 | 0.6 | 3.8 | 0 | 0.6 | 3.8 | | | | | | | |
| Q606 | 2.9 | 1.0 | 8.0 | 2.9 | 1.0 | 8.0 | Q611 | 8.5 | 9.1 | 12.9 | 8.5 | 9.1 | 12.9 | | | | | | | |

★FM Transmit.....0V

| | 1 | 2 | 3 | 4 | 5 | 6 | 7 | 8 | 9 |
|------|-----|-----|-----|-----|---|-----|-----|-----|-----|
| Q602 | 4.7 | 2.8 | 2.2 | 2.1 | 0 | 0.5 | 0.7 | 1.1 | 8.0 |

MARKER Unit (Marker Switch.....ON)

| | E | B | C | | E | B | C | | E | B | C |
|------|-----|-----|-----|------|-----|-----|-----|------|---|-----|-----|
| Q701 | 1.8 | 2.4 | 8.0 | Q702 | 2.1 | 3.7 | 7.7 | Q704 | E | 0.6 | 0.9 |

| | 1 | 2 | 3 | 4 | 5 | 6 | 7 | 8 | 9 | 10 | 11 | 12 | 13 | 14 |
|------|-----|---|-----|-----|-----|-----|---|---|-----|----|-----|-----|----|-----|
| Q703 | 1.8 | E | 3.8 | 4.0 | 4.0 | 4.0 | E | 0 | 4.0 | 0 | 3.7 | 3.0 | 0 | 0.8 |

FM Unit

| | LSB.USB.CW AM | | | FM | | | | LSB.USB.CW AM | | | FM | | | | LSB.USB.CW AM | | | FM | | |
|------|------------------|------|------|------|------|------|------|------------------|------|------|------------------|------------------|------------------|------|------------------|------|------|------------------|------------------|------------------|
| | E(S) | B(G) | C(D) | E(S) | B(G) | C(D) | | E(S) | B(G) | C(D) | E(S) | B(G) | C(D) | | E(S) | B(G) | C(D) | E(S) | B(G) | C(D) |
| Q801 | 1.8 | 2.5 | 7.7 | 1.8 | 2.5 | 7.7 | Q805 | 0 | 0 | 0 | 1.3 [★] | 0.7 [★] | 7.2 [★] | Q809 | 0 | 0 | 0 | 0.6 [★] | 1.3 [★] | 7.0 [★] |
| Q803 | 0 | 1.9 | 5.1 | 0 | 1.9 | 5.1 | Q806 | 0 | 0 | 0 | 1.4 [★] | 2.1 [★] | 2.5 [★] | | | | | | | |
| Q804 | 5.8 | 5.8 | 5.3 | 5.8 | 5.8 | 5.3 | Q807 | 0 | 0 | 0 | 0.7 [★] | 1.4 [★] | 7.0 [★] | | | | | | | |

★FM Transmit.....0V

| | | 1 | 2 | 3 | 4 | 5 | 6 | 7 | 8 |
|------|------|-----|-----|-----|---|-----|-----|-----|-----|
| Q802 | T·R | 7.0 | — | 1.5 | 0 | 1.5 | — | 7.0 | 7.5 |
| Q808 | FM·R | 1.8 | 1.8 | 6.8 | 0 | 5.5 | 1.8 | 1.8 | |
| | T·R | 0 | 0 | 0 | 0 | 0 | 0 | 0 | |

SSB IF Unit

| | E(S) | | B(G) | | C(D) | | | E(S) | | B(G) | | C(D) | | | E(S) | | B(G) | | C(D) | |
|------|------|---|------|---|------|---|------|------|-----|------|-----|------|-----|------|------|-----|------|-----|------|-----|
| | R | T | R | T | R | T | | R | T | R | T | R | T | | R | T | R | T | R | T |
| Q901 | 0.7 | 0 | 0.7 | 0 | 7.3 | 0 | Q905 | 0 | 0 | 0.7 | 0 | 7.2 | 0 | Q908 | 0.3 | 0.3 | 1.0 | 1.0 | 5.8 | 5.8 |
| Q903 | 1.1 | 0 | 0 | 0 | 7.8 | 0 | Q906 | 0 | 0.6 | 0 | 0 | 0 | 7.0 | | | | | | | |
| Q904 | 0.7 | 0 | 0.7 | 0 | 7.3 | 0 | Q907 | 5.3 | 5.3 | 5.9 | 5.9 | 6.8 | 6.8 | | | | | | | |

| | | 1 | 2 | 3 | 4 | 5 | 6 | 7 | 8 |
|------|---|---|-----|---|-----|-----|-----|-----|---|
| Q902 | R | 0 | 1.2 | 0 | 1.8 | 5.5 | 7.6 | 7.3 | 0 |
| | T | 0 | 0 | 0 | 0 | 0 | 0 | 0 | 0 |

TONE BURST Unit

| | | 1 | 2 | 3 | 4 | 5 | 6 | 7 | 8 | 9 | 10 | 11 | 12 | 13 | 14 | 15 | 16 |
|-------|-------|-------|-----|-----|-----|-----|-----|-----|-----|-----|-----|-----|-----|-----|-----|-----|-----|
| | | Q1001 | R | 0 | 0 | 8.0 | 0 | 8.0 | 8.0 | 0 | 0 | 0 | 8.0 | 0 | 8.0 | 7.2 | 8.0 |
| | T | 8.0 | 8.0 | 0 | 8.0 | 0 | 0 | 0 | 0 | 0 | 8.0 | 0 | 8.0 | 7.2 | 8.0 | | |
| Q1002 | R · T | 7.2 | 8.0 | 0 | 8.0 | 0 | 0 | 0 | 0 | 8.0 | 8.0 | 8.0 | 0 | 0 | 8.0 | | |
| Q1003 | R · T | 0 | 0 | 8.0 | 0 | 8.0 | 7.3 | 0 | 8.0 | 8.0 | 0 | 8.0 | 7.2 | 0 | 8.0 | | |
| Q1004 | R | 8.0 | 0 | 7.2 | 0 | 7.3 | 0 | 8.0 | 0 | 0 | 8.0 | 8.0 | 0 | 0 | 7.2 | 0 | 8.0 |
| | T | 8.0 | 0 | 7.2 | 0 | 7.3 | 0 | 8.0 | 0 | 8.0 | 0 | 8.0 | 0 | 0 | 7.3 | 0 | 8.0 |
| Q1005 | R · T | 0 | 8.0 | 0 | 0 | 8.0 | 8.0 | 0 | 0 | 0 | 0 | 0 | 0 | 0 | 8.0 | 0 | 8.0 |

| | S | G | D |
|-------|-----|---|-----|
| Q1006 | 0.9 | 0 | 8.0 |

BOOSTER Unit (on Transmit)

| | LSB.USB.CW | | | AM | | | FM | | | | LSB.USB.CW | | | AM | | | FM | | |
|-------|------------|------|------|------|------|------|------|------|------|-------|------------|------|------|------|------|------|------|------|------|
| | E(S) | B(G) | C(D) | E(S) | B(G) | C(D) | E(S) | B(G) | C(D) | | E(S) | B(G) | C(D) | E(S) | B(G) | C(D) | E(S) | B(G) | C(D) |
| Q1201 | 0 | 0.7 | 12.3 | 0 | 0.6 | 3.6 | 0 | 0.6 | 11.7 | Q1202 | 0 | 0.7 | 13.5 | 0 | 0.4 | 13.3 | 0 | 0.2 | 13.1 |

Receive.....0V

VFO Unit

| | E(S) | B(G) | C(D) | | E(S) | B(G) | C(D) | | E(S) | B(G) | C(D) |
|-------|------|------|------|-------|------|------|------|-------|------|------|------|
| Q1301 | 2.1 | 2.7 | 4.4 | Q1302 | 1.6 | 0 | 7.6 | Q1303 | 1.6 | 2.1 | 6.9 |

MIC AMP Unit

| | LSB. USB | | | | | | CW | | | | | | AM | | | | | | FM | | | | | |
|-------|----------|-----|------|-----|------|-----|------|-----|------|-----|------|-----|------|-----|------|-----|------|-----|------|-----|------|-----|------|-----|
| | E(S) | | B(G) | | C(D) | | E(S) | | B(G) | | C(D) | | E(S) | | B(G) | | C(D) | | E(S) | | B(G) | | C(D) | |
| | R | T | R | T | R | T | R | T | R | T | R | T | R | T | R | T | R | T | R | T | R | T | R | T |
| Q1101 | 0 | 0 | 0 | 0 | 0 | 0 | 0 | 4.9 | 0 | 2.6 | 0 | 8.0 | 0 | 1.9 | 0 | 2.6 | 0 | 7.8 | 0 | 2.2 | 0 | 2.6 | 0 | 7.8 |
| Q1102 | 0 | 0 | 0 | 0 | 0 | 0 | 0 | 0 | 0 | 0 | 0 | 0 | 0 | 0 | 0 | 0 | 0 | 0 | 0 | 1.6 | 0 | 2.2 | 0 | 7.2 |
| Q1103 | 1.5 | 1.5 | 2.1 | 2.1 | 3.9 | 3.9 | 1.5 | 1.5 | 2.1 | 2.1 | 3.9 | 3.9 | 1.5 | 1.5 | 2.1 | 2.1 | 3.9 | 3.9 | 1.5 | 1.5 | 2.1 | 2.1 | 3.9 | 3.9 |
| Q1105 | 0 | 2.2 | 0 | 0 | 0 | 7.8 | 0 | 0 | 0 | 0 | 0 | 0 | 0 | 0 | 0 | 0 | 0 | 0 | 0 | 0 | 0 | 0 | 0 | 0 |
| Q1106 | 0 | 0.7 | 0 | 0 | 0 | 7.3 | 0 | 0 | 0 | 0 | 0 | 0 | 0 | 0 | 0 | 0 | 0 | 0 | 0 | 0 | 0 | 0 | 0 | 0 |
| Q1107 | 3.0 | 3.0 | 3.4 | 3.4 | 6.8 | 6.8 | 3.0 | 4.9 | 3.4 | 3.4 | 6.8 | 8.0 | 2.7 | 3.0 | 3.4 | 3.4 | 6.8 | 6.7 | 2.7 | 2.7 | 3.4 | 3.4 | 6.8 | 6.8 |
| Q1108 | 2.5 | 2.5 | 1.9 | 1.9 | 6.8 | 6.8 | 2.5 | 2.5 | 2.1 | 2.3 | 6.8 | 6.8 | 2.3 | 2.5 | 1.4 | 1.8 | 6.9 | 6.8 | 2.3 | 2.3 | 1.3 | 1.4 | 6.9 | 6.9 |

| | | 1 | 2 | 3 | 4 | 5 | 6 | 7 | 8 | 9 |
|--|-------|-----|-----|-----|-----|-----|-----|-----|-----|-----|
| | Q1104 | R | 4.1 | 2.4 | 1.8 | 1.7 | 0 | 0 | 0 | 0.7 |
| | T | 4.1 | 2.4 | 1.8 | 1.7 | 0 | 0.5 | 3.3 | 1.2 | 6.9 |

REG Unit

| | E | B | C | | E | B | C | | E | B | C |
|-------|-------|------|------|-------|------|-------|-----|----------------|------|------|-------|
| | Q1501 | 14.1 | 14.6 | | 22.6 | Q1503 | 8.7 | | 9.3 | 13.5 | Q1505 |
| Q1502 | 9.0 | 9.7 | 14.6 | Q1504 | 8.0 | 13.5 | 8.7 | Q ₁ | 13.5 | 14.1 | 22.5 |

AM Mod(Q7)

| | E | | B | | C | |
|------------------|---|------|---|------|---|------|
| | R | T | R | T | R | T |
| USB USB CW | 0 | 12.3 | 0 | 12.9 | 0 | 13.5 |
| AM | 0 | 3.6 | 0 | 4.2 | 0 | 13.4 |
| FM | 0 | 11.7 | 0 | 12.3 | 0 | 13.2 |

PARTS LIST

| MAIN CHASSIS | | | | 6, 7 | SLE-12251 |
|---------------------------------|----------------|-------------|--|---------------------------------|--------------------|
| PB PRINTED CIRCUIT BOARD | | | | 8 | SLE-14201 |
| 1471 (A~Z) | LED | BOARD | | 9 | SLE-14301 |
| 1552 (A~Z) | SWITCH | BOARD | | J | JACK |
| Q TRANSISTOR | | | | 1 | QMS-AB4M |
| 1 | | 2SD114 | | 2 | CS-250 |
| 7 | | 2SD313D | | 3 | SG-7615 |
| D DIODE | | | | 4 | SG-8050 |
| 1 | Si Bridge | DS-130-YD | | 5 | FM-144J |
| 6~10 | Si | 10D-1 | | 6 | XG-8018 |
| 11 | LED | GD-4 | | 7~10 | CN-7017J |
| 12 | | RD-4 | | 11 | SO-239 |
| 13 | | TLR-108 | | 12, 14~19, 21 | 3305-018-011 |
| R RESISTOR | | | | 13, 20, 22 | 1150-036-009 |
| CARBON COMPOSITION | | | | 25 | CN-1463 |
| 16 | 1/4W | 10KΩ | | 24 | SI-3101 |
| 15 | 1/4W | 100KΩ | | P PLUG | |
| 19 | 1/2W | 10Ω | | 24 | SI-8501 |
| 17 | 1/2W | 56Ω | | F FUSE | |
| 18 | 1/2W | 100Ω | | 1 | 2A 100V~117V |
| 14, | 1/2W | 220Ω | | | 1A 200V~234V |
| 13, 21 | 1/2W | 470Ω | | FS FUSE HOLDER | |
| 23 | 1/2W | 5.6KΩ | | 1 | SN-1001 #2 |
| 11 | 1/2W | 22KΩ | | PL PILOT LAMP | |
| 12 | 1/2W | 27KΩ | | 1~3 | 14V 40mA |
| VR POTENTIOMETER | | | | FIX UNIT | |
| 4 | EWK-DOAS 15023 | 500ΩB/500ΩC | | PB PRINTED CIRCUIT BOARD | |
| 5 | VM13A-5M3121 | 5KA | | 1453 (A~Z) FIX OSC CIRCUIT | |
| 8 | EVH-BOAS-15A53 | 5KA | | 1500 (A~Z) CRYSTAL BOARD | |
| 6 | VM20A | 5KB | | Q TRANSISTOR | |
| 7 | VM11A5M | 10KA | | 101, 102 | 2SC372Y |
| 3 | EVH-BOAS-15B54 | 50KB | | D DIODE | |
| 10 | EVH-BOAS-15B53 | 5KB | | 101~111 | Si 1S1555 |
| 9 | EVL-SOAA-00B54 | 50KB | | X CRYSTAL | |
| C CAPACITOR | | | | 101~111 | HC-25/U (OPTION) |
| DIPPED MICA | | | | XS CRYSTAL SOCKET | |
| 16, 17, 18 | 50WV | 100PF | | 101~111 | S2-101P |
| 22 | 50WV | 300PF | | R RESISTOR | |
| CERAMIC DISC | | | | CARBON FILM | |
| 14, 28~32 | 50WV | 0.001μF | | 105, 108, 109 | 1/4W 100Ω |
| 33, 13 | 50WV | 0.01μF | | 104 | 1/4W 220Ω |
| 11~12, 15, 19~21, 23, 27 | 50WV | 0.047μF | | 101 | 1/4W 1.5KΩ |
| 24~26 | 500WV | 0.01μF | | 102, 107 | 1/4W 5.6KΩ |
| 1, 2 | 1.4KV | 0.0047μF | | 106 | 1/4W 8.2KΩ |
| ELECTROLYTIC | | | | 103 | 1/4W 22KΩ |
| 10 | 16WV | 2200μF | | C CAPACITOR | |
| PT POWER TRANSFORMER | | | | DIPPED MICA | |
| 1 | 52-36 | | | 130 | 50WV 15PF |
| CH CHOKE COIL | | | | 131 | 50WV 20PF |
| 1 | SN-8S-500 | | | 117~127 | 50WV 30PF |
| M METER | | | | 129 | 50WV 100PF |
| 1 | SP-38A | | | 128, 132 | 50WV 200PF |
| SP SPEAKER | | | | CERAMIC DISC | |
| 1 | SA-70H | | | 101~116 | 50WV 0.01μF |
| RL RELAY | | | | TC TRIMMER CAPACITOR | |
| 1 | AE-3171 | | | 101~111 | ECV-1ZW 20×40 20PF |
| RLS RELAY SOCKET | | | | L INDUCTOR | |
| 1 | AE-3860 | | | | |
| S SWITCH | | | | | |
| 1 | ESR E22CR15D | | | | |
| 2 | ESR 448R15A | | | | |
| 3 | ESR 485R15A | | | | |
| 4 | SP 2022 | | | | |
| 5 | SLE-12301 | | | | |

| | | | | | |
|----------------------------|------------------------|----------------|--|-----------------------|---------------|
| 101~111 | EL0610-102K | 1mH | PLL UNIT | | |
| 112 | EL0610-251K | 250 μ H | PB | PRINTED CIRCUIT BOARD | |
| 113 | FL-3H 1R2M | 1.2 μ H | 1455 (A~Z) | PLL CIRCUIT | |
| | | | Q | IC FET & TRANSISTOR | |
| LOCAL UNIT | | | 302 | IC | μ A703HC |
| PB | PRINTED CIRCUIT BOARD | | 308 | | TP4011AN |
| 1454 (A~Z) | LOCAL OSC CIRCUIT | | 301 | FET | 2SK19Y |
| TRANSISTOR | | | 305, 306 | " | 2SK19GR |
| 201 | 2SC372Y | | 303, 304, 309 | | 2SC372Y |
| 202, 203 | 2SC784R | | 307 | | 2SC784R |
| | | | 310 | | MPSA13 |
| DIODE | | | DIODE | | |
| D | | | 301 | PUT | N13T1 |
| 201~212 | Si | 1S1555 | 309, 310 | Si | 1S1555 |
| 225 | Ge | 1S188FM | 311 | Ge | 1S188FM |
| 226 | Varactor | 1SV50 | 303, 304 | | 1S1007 |
| CRYSTAL | | | 302 | Zener | WZ061 |
| 201 | HC-18/U | 13.92222MHz | 305, 306 | Varactor | 1SV50 |
| 202 | " | 13.97777MHz | 307, 308 | Varactor | 1S2209 |
| 203 | " | 14.03333MHz | RESISTOR | | |
| 204 | " | 14.08888MHz | CARBON FILM | | |
| 205 | " | 14.14444MHz | 305 | $\frac{1}{4}$ W | 22 Ω |
| 206 | " | 14.20000MHz | 337 | $\frac{1}{4}$ W | 56 Ω |
| 207 | " | 14.25555MHz | 313,315,319,320,329,333,334 | $\frac{1}{4}$ W | 100 Ω |
| 208 | " | 14.31111MHz | 303 | $\frac{1}{4}$ W | 150 Ω |
| 210 (Repeater) | HC-25/U | ★(14.13333MHz) | 304, 308, 314, 326, 328 | $\frac{1}{4}$ W | 220 Ω |
| 211 (Repeater) | " | ★(14.32222MHz) | 325 | $\frac{1}{4}$ W | 270 Ω |
| ★US Model★★European Model★ | " | ★(14.02222MHz) | 307 | $\frac{1}{4}$ W | 330 Ω |
| ★US Model★★European Model★ | " | ★(14.02222MHz) | 310, 316, | $\frac{1}{4}$ W | 1K Ω |
| XS | CRYSTAL SOCKET | | 302, 345, 346 | $\frac{1}{4}$ W | 2.2K Ω |
| 201 | S-14 | | 317, 321, 330 | $\frac{1}{4}$ W | 4.7K Ω |
| RESISTOR | | | 311, 312 | $\frac{1}{4}$ W | 10K Ω |
| CARBON FILM | | | 306, 318, 322, 331 | $\frac{1}{4}$ W | 22K Ω |
| 221, 225 | $\frac{1}{4}$ W | 100 Ω | 301 | $\frac{1}{4}$ W | 47K Ω |
| 217, 224 | $\frac{1}{4}$ W | 220 Ω | 309, 323, 324, 327, 340, 344 | $\frac{1}{4}$ W | 100K Ω |
| 220 | $\frac{1}{4}$ W | 560 Ω | 339 | $\frac{1}{4}$ W | 560K Ω |
| 213, 216, 226 | $\frac{1}{4}$ W | 1K Ω | 332, 336, 338, 341, 343 | $\frac{1}{4}$ W | 1M Ω |
| 222 | $\frac{1}{4}$ W | 2.2K Ω | CARBON COMPOSITION | | |
| 201~212 | $\frac{1}{4}$ W | 3.3K Ω | 342 | $\frac{1}{4}$ W | 2.2M Ω |
| 215, 218 | $\frac{1}{4}$ W | 4.7K Ω | THERMISTOR | | |
| 214, 223 | $\frac{1}{4}$ W | 10K Ω | 301 | SDT-250 | |
| 219 | $\frac{1}{4}$ W | 22K Ω | POTENTIOMETER | | |
| | | | 301 | KVL SOAA-00B13 | |
| | | | 1KB | | |
| CAPACITOR | | | CAPACITOR | | |
| DIPPED MICA | | | DIPPED MICA | | |
| 242 | 50WV | 1PF | 322, 327 | 50WV | 5PF |
| 239 | 50WV | 5PF | 339, 340 | 50WV | 6PF |
| 240, 241 | 50WV | 8PF | 318, 319 | 50WV | 10PF |
| 213~224, 236, 238 | 50WV | 30PF | 308, 309 | 50WV | 20PF |
| 237 | 50WV | 39PF | 325, 326 | 50WV | 30PF |
| 234 | 50WV | 150PF | 323, 324 | 50WV | 47PF |
| 235 | 50WV | 200PF | 305, 312, 313 | 50WV | 170PF |
| CERAMIC DISC | | | 307 | 50WV | 200PF |
| 201~212, 225~230, 232, 233 | 50WV | 0.01 μ F | CERAMIC DISC | | |
| 231, 243 | 50WV | 0.047 μ F | 304, 306, 310, 311, 314~317 | 50WV | 0.01 μ F |
| TRIMMER CAPACITOR | | | 320, 321, 328, 329, 331~336, 344, 345, 338 | | |
| MYLAR | | | | | |
| 201~212 | ECV-1ZW 20 \times 40 | 20PF | 341 | 50WV | 0.01 μ F |
| INDUCTOR | | | 343 | 50WV | 0.1 μ F |
| 203 | # 221026 | 3.2 μ H | TANTALUM | | |
| 202, 204, 201 | EL0610-220K | 22 μ H | 301, 342 | 35WV | 0.1 μ F |
| | | | ELECTROLYTIC | | |
| | | | 303, 330 | 16WV | 10 μ F |
| TRANSFORMER | | | 302 | 16WV | 100 μ F |
| 201 | R-12 | #4797 | | | |
| 202, 203 | R-12 | #4102 | | | |

| | | | | | |
|------------------------------------|---------------|---------|-----------------------------|----------------|---------|
| 511, 512, 514, 519 | 50WV | 5PF | 634, 613 | 1/4 W | 47KΩ |
| 507, 508, 516, 523, 537, 538 | 50WV | 10PF | 603, 633, 637 | 1/4 W | 100KΩ |
| 510, 506, 535 | 50WV | 20PF | 607 | 1/4 W | 1MΩ |
| 528 | 50WV | 27PF | | | |
| CERAMIC DISC | | | CARBON COMPOSITION | | |
| 513, 534 | 50WV | 1PF | 608, 609 | 1/2 W | 3.3MΩ |
| 502, 503 | 50WV | 0.001μF | 610 | 1/2 W | 5.6MΩ |
| 501, 504, 505, 509, 515, | 50WV | 0.01μF | WIRE WOUND | | |
| 517, 518, 520 ~ 522, 524, 526, 536 | | | 645, 646 | 1/2 W | 0.22Ω |
| MYLAR | | | RS THERMISTOR | | |
| 532 | 50WV | 0.047μF | 601 | SDT-250 | |
| ELECTROLYTIC | | | VR POTENTIOMETER | | |
| 525, 527, 529, 531 | 16WV | 10μF | 605 | EVL-SOAA-00B53 | 5KB |
| 530 | 16WV | 22μF | 602, 603 | EVL-VOAA-00B14 | 10KB |
| 533 | | 33μF | 604 | EVL-SOAA-00B14 | 10KB |
| TC TRIMMER CAPACITOR | | | 606 | EVL-SOAA-00B54 | 50KB |
| 501 ~ 505 | ECV-1ZW 10×40 | 10PF | 601 | EVL-VOAA-00B26 | 2MB |
| 506 | ECV 1ZW 20×51 | 20PF | C CAPACITOR | | |
| 507, 508 | ECV 1ZW 20×32 | 20PF | DIPPED MICA | | |
| L INDUCTOR | | | 637 | 50WV | 200PF |
| 503 | # 221008 | | 635 | 50WV | 280PF |
| 504, 502 | # 221009 | | 628 | 50WV | 330PF |
| 507, 510 | # 221018 | | CERAMIC DISC | | |
| 508, 509 | # 221017 | | 605 | 50WV | 470PF |
| 506 | # 221036 | | 636 | 50WV | 0.047μF |
| T TRANSFORMER | | | MYLAR | | |
| 501 | R-12 4073 | | 610, 615 | 50WV | 0.001μF |
| 502 | # 221035 | | 629, 630 | 50WV | 0.002μF |
| AF UNIT | | | 608, 611, 619, 620 | 50WV | 0.01μF |
| PB PRINTED CIRCUIT BOARD | | | 616 ~ 618 | 50WV | 0.02μF |
| 1499 (A ~ Z) AF CIRCUIT | | | 614, 631 | 50WV | 0.047μF |
| | | | 609 | 50WV | 0.1μF |
| | | | ELECTROLYTIC | | |
| Q IC FET & TRANSISTOR | | | 601, 612, 623, 626 | 16WV | 1μF |
| 602 | IC | LD-3001 | 621, 622 | 16WV | 4.7μF |
| 603 | FET | 2SK19Y | 602 ~ 604, 606, 607, 613 | 16WV | 10μF |
| 608, 609 | " | 2SK19GR | 624 | 10WV | 100μF |
| 612 | | 2SA695 | 625, 633 | 16WV | 100μF |
| 614 | | 2SB529 | 627, 632 | 16WV | 220μF |
| 601, 605, 606, 607, 610 | | 2SC372Y | MARKER UNIT | | |
| 611 | | 2SC711 | PB PRINTED CIRCUIT BOARD | | |
| 604 | | 2SC735Y | 1499 (A ~ Z) MARKER CIRCUIT | | |
| 613 | | 2SD359 | | | |
| D DIODE | | | Q IC & TRANSISTOR | | |
| 601 ~ 604 | Si | 1S1555 | 703 | IC | 34024PC |
| 605 | Varistor | MV-5W | 701, 702, 704 | Tr | 2SC372Y |
| R RESISTOR | | | X CRYSTAL | | |
| CARBON FILM | | | 701 | HC-18/U | 12.8MHz |
| 642 | 1/4 W | 10Ω | R RESISTOR | | |
| 641 | 1/4 W | 22Ω | CARBON FILM | | |
| 628 | 1/4 W | 100Ω | 701 ~ 708 | 1/4 W | 100Ω |
| 647 | 1/4 W | 180Ω | 711, 713 | 1/4 W | 1KΩ |
| 622, 629, 644 | 1/4 W | 220Ω | 716 | 1/4 W | 2.2KΩ |
| 626 | 1/4 W | 470Ω | 710 | 1/4 W | 10KΩ |
| 611 | 1/4 W | 680Ω | 709, 715 | 1/4 W | 22KΩ |
| 601, 616, 638, 639 | 1/4 W | 1KΩ | 714 | 1/4 W | 100KΩ |
| 604, 635, 636 | 1/4 W | 1.5KΩ | 712 | 1/4 W | 220KΩ |
| 623, 624, 625, 631 | 1/4 W | 2.2KΩ | VR POTENTIOMETER | | |
| 605, 614, 643 | 1/4 W | 3.3KΩ | 701 ~ 708 | EVL-SOAA-00B14 | 10KB |
| 606, 612, 618, 619, 620, 627 | 1/4 W | 4.7KΩ | C CAPACITOR | | |
| 617 | 1/4 W | 5.6KΩ | DIPPED MICA | | |
| 630, 632 | 1/4 W | 6.8KΩ | 709 | 50WV | 3PF |
| 602 | 1/4 W | 15KΩ | 701, 707 | 50WV | 27PF |
| 615 | 1/4 W | 22KΩ | 702, 703 | 50WV | 220PF |
| 621 | 1/4 W | 33KΩ | | | |
| 640 | 1/4 W | 39KΩ | | | |

| | | | | | |
|---------------------------|-----------------------|----------------|------------------------------|-----------------|---------------|
| CERAMIC DISC | | | 810, 830, 831, 837, 838, 841 | 50WV | 0.01 μ F |
| 704 ~ 706, 708 | 50WV | 0.01 μ F | 828, 829 | 50WV | 0.02 μ F |
| | | | 811, 817, 818, 820 ~ 825 | 50WV | 0.047 μ F |
| ELECTROLYTIC | | | STYROL | | |
| 710 | 16WV | 10 μ F | 826 | 50WV | 330PF |
| | | | 827 | 50WV | 1000PF |
| TC | TRIMMER CAPACITOR | | TANTALUM | | |
| 701 | ECV-1ZW | 20 \times 40 | 20PF | 839, 840 | 25WV |
| | | | ELECTROLYTIC | | |
| L | INDUCTOR | | 849, 850 | 16WV | 1 μ F |
| 702 | RFC | 22 μ H | 832, 842 | 16WV | 4.7 μ F |
| 701 | RFC | 250 μ H | | | |
| FM IF UNIT | | | L INDUCTOR | | |
| PB | PRINTED CIRCUIT BOARD | | 804 | EL0610-251K | 250 μ H |
| 1463 (A ~ Z) | FM IF CIRCUIT | | 801 ~ 803, 806, 807 | EL0610-102K | 1mH |
| | | | 805 | EL0610-202K | 2mH |
| Q | IC FET & TRANSISTOR | | T TRANSFORMER | | |
| 802 | IC | μ A703HC | 801, 802 | R-12 | 4074 |
| 808 | " | TA7061AP | 803 | | 4861D |
| 803 | FET | 2SK19GR | 804 | | 4861E |
| 801, 804 ~ 807, 809 ~ 811 | | 2SC372Y | 805 | | 3004 |
| D | DIODE | | | | |
| 801, 802, 807 ~ 810 | Si | 1S1555 | | | |
| 803 ~ 806 | Ge | 1S188FM | | | |
| | | | SSB IF UNIT | | |
| X | CRYSTAL | | PB PRINTED CIRCUIT BOARD | | |
| 801 | HC-18/U | 10.245MHz | 1462 (A ~ Z) SSB IF CIRCUIT | | |
| CF | CERAMIC FILTER | | Q IC FET & TRANSISTOR | | |
| 802 | CFM 455F | | 902 | IC | TA7045M |
| 803 | 10.7MF-BR | | 903, 906 | FET | 2SK19GR |
| | | | 904, 905 | | 2SC373 |
| | | | 901 | | 2SC784R |
| | | | 907, 908 | | 2SC1000GR |
| R | RESISTOR | | D DIODE | | |
| CARBON | | | 901 ~ 903, 912, 913 | Si | 1S1555 |
| 804, 805, 826 | $\frac{1}{4}$ W | 100 Ω | 910 | Ge | 1S188FM |
| 825, 827, 837 | $\frac{1}{4}$ W | 220 Ω | 904 ~ 907, 909 | G.B | 1S1007 |
| 824 | $\frac{1}{4}$ W | 470 Ω | 911 | Zener | WZ110 |
| 803, 833, 842 | $\frac{1}{4}$ W | 560 Ω | XF CRYSTAL FILTER | | |
| 808, 816, 819, 828, 829, | $\frac{1}{4}$ W | 1K Ω | 901 | XF-10A | |
| 836, 846, 847 | | | R RESISTOR | | |
| 809 | $\frac{1}{4}$ W | 1.5K Ω | CARBON FILM | | |
| 839, 840 | $\frac{1}{4}$ W | 2.2K Ω | 909, 912, 914, 915, 919, | $\frac{1}{4}$ W | 100 Ω |
| 811, 813, 814, 821, 843, | $\frac{1}{4}$ W | 3.3K Ω | 932, 933, 939, 940 | | |
| 849 ~ 856 | | | 926, 928 | $\frac{1}{4}$ W | 270 Ω |
| 801, 830, 831, 835, 844 | $\frac{1}{4}$ W | 4.7K Ω | 917, 944 | $\frac{1}{4}$ W | 470 Ω |
| 822, 838 | $\frac{1}{4}$ W | 5.6K Ω | 901, 902, 927 | $\frac{1}{4}$ W | 560 Ω |
| 802 | $\frac{1}{4}$ W | 10K Ω | 934, 938, 946, 947, 905 | $\frac{1}{4}$ W | 1K Ω |
| 815, 845 | $\frac{1}{4}$ W | 15K Ω | 911, 913, 921 | | |
| 823, 834, 841 | $\frac{1}{4}$ W | 22K Ω | 922 | $\frac{1}{4}$ W | 1.5K Ω |
| 820, 832 | $\frac{1}{4}$ W | 47K Ω | 929 | $\frac{1}{4}$ W | 1.8K Ω |
| 848 | $\frac{1}{4}$ W | 56K Ω | 908, 910, 918, 930, 945, 924 | $\frac{1}{4}$ W | 2.2K Ω |
| 806, 807, 810 | $\frac{1}{4}$ W | 100K Ω | 925 | $\frac{1}{4}$ W | 2.7K Ω |
| RS | THERMISTOR | | 903, 904, 942 | $\frac{1}{4}$ W | 3.3K Ω |
| 801 | SDT-250 | | 935, 936 | $\frac{1}{4}$ W | 4.7K Ω |
| C | CAPACITOR | | 906 | $\frac{1}{4}$ W | 6.8K Ω |
| DIPPED MICA | | | 941 | $\frac{1}{4}$ W | 10K Ω |
| 812 | 50WV | 15PF | 920, 943 | $\frac{1}{4}$ W | 22K Ω |
| 806, 807 | 50WV | 30PF | 907 | $\frac{1}{4}$ W | 27K Ω |
| 833 | 50WV | 40PF | 937 | $\frac{1}{4}$ W | 56K Ω |
| 809, 835, 843 | 50WV | 100PF | 916, 931 | $\frac{1}{4}$ W | 100K Ω |
| 801 | 50WV | 200PF | 923 | $\frac{1}{4}$ W | 470K Ω |
| 834 | 50WV | 300PF | CERAMIC DISC | | |
| 844 | 50WV | 0.001 μ F | | | |
| 802 ~ 805, 808, 813, 815, | 50WV | 0.01 μ F | RS THERMISTOR | | |
| 816, 819, 836, 845 ~ 848 | | | 901 | SDT-250 | |
| MYLAR | | | | | |

| | | | | | |
|-----------------------------|------------------------------|----------------|--|--------------------------------|---------------|
| VR | POTENTIOMETER | | 1012 | 16WV | 1 μ F |
| 901 | EVL-SOAA-00B52 | 500B | 1013 | 16WV | 4.7 μ F |
| 903 | EVL-SOAA-00B13 | 1KB | 1011 | 16WV | 100 μ F |
| 902 | EVL-SOAA-00B53 | 5KB | | | |
| C | CAPACITOR | | RL | RELAY | |
| | DIPPED MICA | | 1001 | LZ-2G | |
| 915 | 50WV | 10PF | | | |
| 912 | 50WV | 20PF | | | |
| 916 | 50WV | 100PF | | | |
| | CERAMIC DISC | | PB | PRINTED CIRCUIT BOARD | |
| 901, 902, 909~911, 906 | 50WV | 0.01 μ F | 1460 (A~Z) | MIC AMP CIRCUIT | |
| 917, 918, 920, 923~929, 933 | | | | | |
| 903~905, 907, 908, 913, 914 | 50WV | 0.047 μ F | Q | IC FET & TRANSISTOR | |
| | MYLAR | | 1104 | IC | LD-3001 |
| 932 | 50WV | 0.0047 μ F | 1105, 1106 | FET | 2SK19GR |
| 936, 940 | 50WV | 0.02 μ F | 1101~1103, 1107, 1108 | | 2SC372Y |
| 931, 937 | 50WV | 0.047 μ F | D | DIODE | |
| | ELECTROLYTIC | | 1101, 1105, 1106, 1112~1114, 1117 | Si | 1S1555 |
| 930, 939 | 16WV | 1 μ F | 1103, 1104 | Ge | 1S188FM |
| 938 | 16WV | 10 μ F | 1108~1111 | G.B | 1S1007 |
| 934, 935, 922 | 16WV | 47 μ F | 1102 | Varactor | 1S2687 |
| | TANTALUM | | X | CRYSTAL | |
| 921 | 35WV | 0.1 μ F | 1101 | HC-18/U | 10.7000MHz |
| TC | TRIMMER CAPACITOR | | 1102 | HC-18/U | 10.7015MHz |
| 901 | ECV-1ZW 50 \times 40 | 50PF | 1103 | HC-18/U | 10.6985MHz |
| L | INDUCTOR | | 1104 | HC-18/U | 10.6993MHz |
| 901 | EL0610-251K | 250 μ H | | | |
| T | TRANSFORMER | | R | RESISTOR | |
| 901, 902 | R-12 | 4074 | | CARBON FILM | |
| 903 | R-12 | 4073 | 1101, 1105, 1121, 1124, 1129 | $\frac{1}{4}$ W | 100 Ω |
| | | | 1133, 1141, 1148, 1149, 1150, 1152, 1153 | | |
| | | | 1112, 1135, 1136, 1138, 1142, 1137 | $\frac{1}{4}$ W | 220 Ω |
| PB | PRINTED CIRCUIT BOARD | | 1114, 1102 | $\frac{1}{4}$ W | 470 Ω |
| 1461 (A~Z) | TONE BURST CIRCUIT | | 1106, 1113, 1125, 1127, 1145 | $\frac{1}{4}$ W | 1K Ω |
| | | | 1117, 1122, 1123, 1147, 1151 | $\frac{1}{4}$ W | 2.2K Ω |
| Q | IC & FET | | 1104, 1128 | $\frac{1}{4}$ W | 3.3K Ω |
| 1001~1003 | IC | TP4011AN | 1143 | $\frac{1}{4}$ W | 4.7K Ω |
| 1005 | | TP4027AN | 1116, 1140, 1144 | $\frac{1}{4}$ W | 5.6K Ω |
| 1004 | | TP4049AN | 1139 | $\frac{1}{4}$ W | 6.8K Ω |
| 1006 | FET | 2SK19GR | 1108, 1118, 1120 | $\frac{1}{4}$ W | 10K Ω |
| | | | 1115, | $\frac{1}{4}$ W | 12K Ω |
| D | DIODE | | 1107, 1111 | $\frac{1}{4}$ W | 22K Ω |
| 1001~1003 | Ge | 1S188FM | 1103 | $\frac{1}{4}$ W | 27K Ω |
| R | RESISTOR | | 1110, 1119 | $\frac{1}{4}$ W | 33K Ω |
| | CARBON FILM | | 1109, 1126, 1130 | $\frac{1}{4}$ W | 100K Ω |
| 1014 | $\frac{1}{4}$ W | 220 Ω | VR | POTENTIOMETER | |
| 1013 | $\frac{1}{4}$ W | 10K Ω | 1102 | EVL-SOAA-00B32 | 300B |
| 1015 | $\frac{1}{4}$ W | 39K Ω | 1103 | EVL-SOAA-00B13 | 1KB |
| 1011 | $\frac{1}{4}$ W | 180K Ω | 1101 | EVL-SOAA-00B23 | 2KB |
| 1012 | $\frac{1}{4}$ W | 820K Ω | C | CAPACITOR | |
| 1001~1005, 1008~1010 | $\frac{1}{4}$ W | 1M Ω | | DIPPED MICA | |
| | | | 1159 | 50WV | 5PF |
| | | | 1158, 1133 | 50WV | 10PF |
| 1006, 1007 | $\frac{1}{4}$ W | 2.2M Ω | 1106 | 50WV | 15PF |
| VR | POTENTIOMETER | | 1146 | 50WV | 20PF |
| 1002, 1003 | EVL-SOAA-00B15 | 100KB | 1140, 1154~1156 | 50WV | 30PF |
| 1001 | EVL-SOAA-00B26 | 2MB | | 50WV | |
| C | CAPACITOR | | 1107, 1108, 1147 | 50WV | 100PF |
| | DIPPED MICA | | 1148 | 50WV | 150PF |
| 1009 | 50WV | 1000PF | 1143 | 50WV | 200PF |
| | MYLAR | | 1110 | 50WV | 250PF |
| 1001, 1002, 1004, 1005, | 50WV | 0.01 μ F | 1126~1128 | 50WV | 270PF |
| 1007, 1010 | | | | CERAMIC DISC | |
| | TANTALUM | | 1136 | 50WV | 0.001 μ F |
| 1003 | 35WV | 0.33 μ F | 1101, 1102, 1104, | 50WV | 0.01 μ F |
| 1006, 1008 | 35WV | 0.47 μ F | 1134~1135, 1138, 1139, 1141, | | |
| | ELECTROLYTIC | | 1142, 1144, 1145, 1149~1153 | | |
| | | | 1109, | 50WV | 0.047 μ F |

| | | | |
|---|---------------------------------|------------------------|---------------|
| MYLAR | 1203, 1207, 1209 | 16WV | 10 μ F |
| 1111, 1115, 1116, 1122, 1132 50WV 0.047 μ F | | | |
| ELECTROLYTIC | TC TRIMMER CAPACITOR | | |
| 1114, 1117, 1129, 1131 16WV 1 μ F | 1201 | ECV-1ZW 50 \times 40 | 50PF |
| 1118, 1119, 1121, 1123~1125, 16WV 10 μ F | 1202~1204 | TSN-P-100DS | 20PF |
| 1130 | | | |
| 1120 16WV 22 μ F | L INDUCTOR | | |
| 1112, 1113 16WV 47 μ F | 1201, 1207 | # 221019 | |
| | 1204, 1206, 1208, 1209 | # 221020 | |
| TC TRIMMER CAPACITOR | 1211, 1212 | # 221021 | |
| 1102~1104 ECV-1ZW 20 \times 40 20PF | 1202, 1203 | # 221022 | |
| 1101 ECV-1ZW 50 \times 40 50PF | 1205 | # 221037 | |
| | 1210 | EL0610-220K | 22 μ H |
| L INDUCTOR | | | |
| 1101 # 221024 | RL RELAY | | |
| 1107 EL0610-100K 10 μ H | 1201 | LZ-2G DC12 | 450 Ω |
| 1106, 1108~1112 EL0610-102K 1mH | | | |
| | VFO UNIT | | |
| T TRANSFORMER | PB PRINTED CIRCUIT BOARD | | |
| 1101 R-12 # 4074 | 1465 (A~Z) | VFO CIRCUIT | |
| 1102 R-12 # 4073 | | | |
| BOOSTER UNIT | Q FET & TRANSISTOR | | |
| PB PRINTED CIRCUIT BOARD | 1302 | FET 2SK19GR | |
| 1470 (A~Z) BOOSTER CIRCUIT | 1301, 1303 | 2SC372Y | |
| | | | |
| Q TRANSISTOR | R RESISTOR | | |
| | CARBON FILM | | |
| 1201 2N5590 | 1307, 1311, 1312 | $\frac{1}{4}$ W | 100 Ω |
| 1202 2N5591 | 1310 | $\frac{1}{4}$ W | 150 Ω |
| | 1306 | $\frac{1}{4}$ W | 470 Ω |
| D DIODE | 1304 | $\frac{1}{4}$ W | 2.2K Ω |
| 1201, 1202 Si 10D-1 | 1301 | $\frac{1}{4}$ W | 3.3K Ω |
| 1203, 1205~1208 1S1555 | 1308 | $\frac{1}{4}$ W | 6.8K Ω |
| 1204 Ge 1S188FM | 1309 | $\frac{1}{4}$ W | 15K Ω |
| 1209 Zener 1N4740 | 1302 | $\frac{1}{4}$ W | 18K Ω |
| | 1303 | $\frac{1}{4}$ W | 33K Ω |
| R RESISTOR | 1305 | $\frac{1}{4}$ W | 100K Ω |
| CARBON COMPOSITION | | | |
| 1204 $\frac{1}{2}$ W 10 Ω | C CAPACITOR | | |
| 1201 $\frac{1}{2}$ W 22 Ω | DIPPED MICA | | |
| 1203 $\frac{1}{2}$ W 56 Ω | 1318 | 50WV | 2PF |
| 1205 $\frac{1}{2}$ W 100 Ω | 1302 | 50WV | 20PF |
| 1202 $\frac{1}{2}$ W 330 Ω | 1313 | 50WV | 39PF |
| 1206 $\frac{1}{2}$ W 100K Ω | 1306 | 50WV | 51PF |
| 1207 $\frac{1}{2}$ W 1M Ω | 1311 | 50WV | 68PF |
| | 1307 | 50WV | 270PF |
| VR POTENTIOMETER | 1310 | 50WV | 470PF |
| 1201 EVL-SOAA-00B14 10KB | | | |
| 1202 EVL-SOAA-00B54 50KB | | | |
| | | | |
| C CAPACITOR | CERAMIC DISC | | |
| DIPPED MICA | 1308, 1309, 1312, | 50WV | 0.01 μ F |
| 1216 50WV 2PF | 1314~1316 | | |
| 1217, 1223 50WV 5PF | | | |
| 1201 50WV 10PF | CERAMIC TC | | |
| 1224 50WV 12PF | 1303 | 500WV | 5PF UJ |
| 1213~1215 50WV 20PF | 1304 | 500WV | 10PF UJ |
| 1205 50WV 33PF | 1301 | 500WV | 20PF UJ |
| 1212 50WV 39PF | 1305 | 500WV | 82PF NPO |
| 1211 50WV 68PF | | | |
| 1206 50WV 100PF | | | |
| | CERAMIC FEED THRU | | |
| CERAMIC DISC | 1317 | ECK-L1H102PE | 1000PF |
| 1202, 1204, 1208, 1210 50WV 0.001 μ F | | | |
| 1218~1220 50WV 0.01 μ F | VC VARIABLE CAPACITOR | | |
| MYLAR | 1301 | C521 | |
| 1221 50WV 0.001 μ F | TC TRIMMER CAPACITOR | | |
| TANTALUM | 1301 | MC10P \times 2 | |
| 1222 35WV 0.1 μ F | 1302 | KC-30P | |
| ELECTROLYTIC | L INDUCTOR | | |
| | 1301 | # 221025A | |
| | 1302 | EL0610-680K | 68 μ H |
| | 1303 | EL0610-251K | 250 μ H |

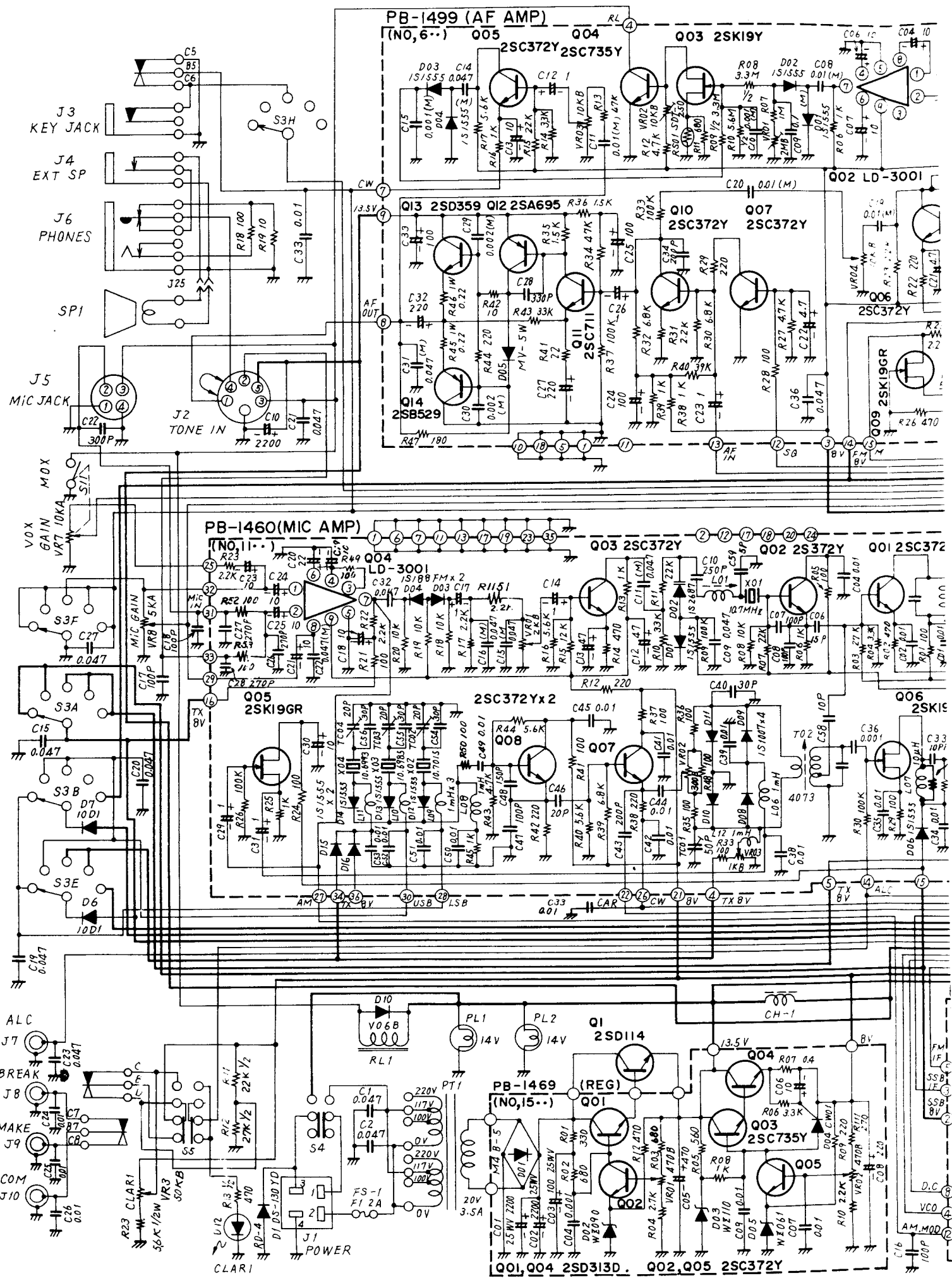

PB-1463(FM IF)

(NO.8...)

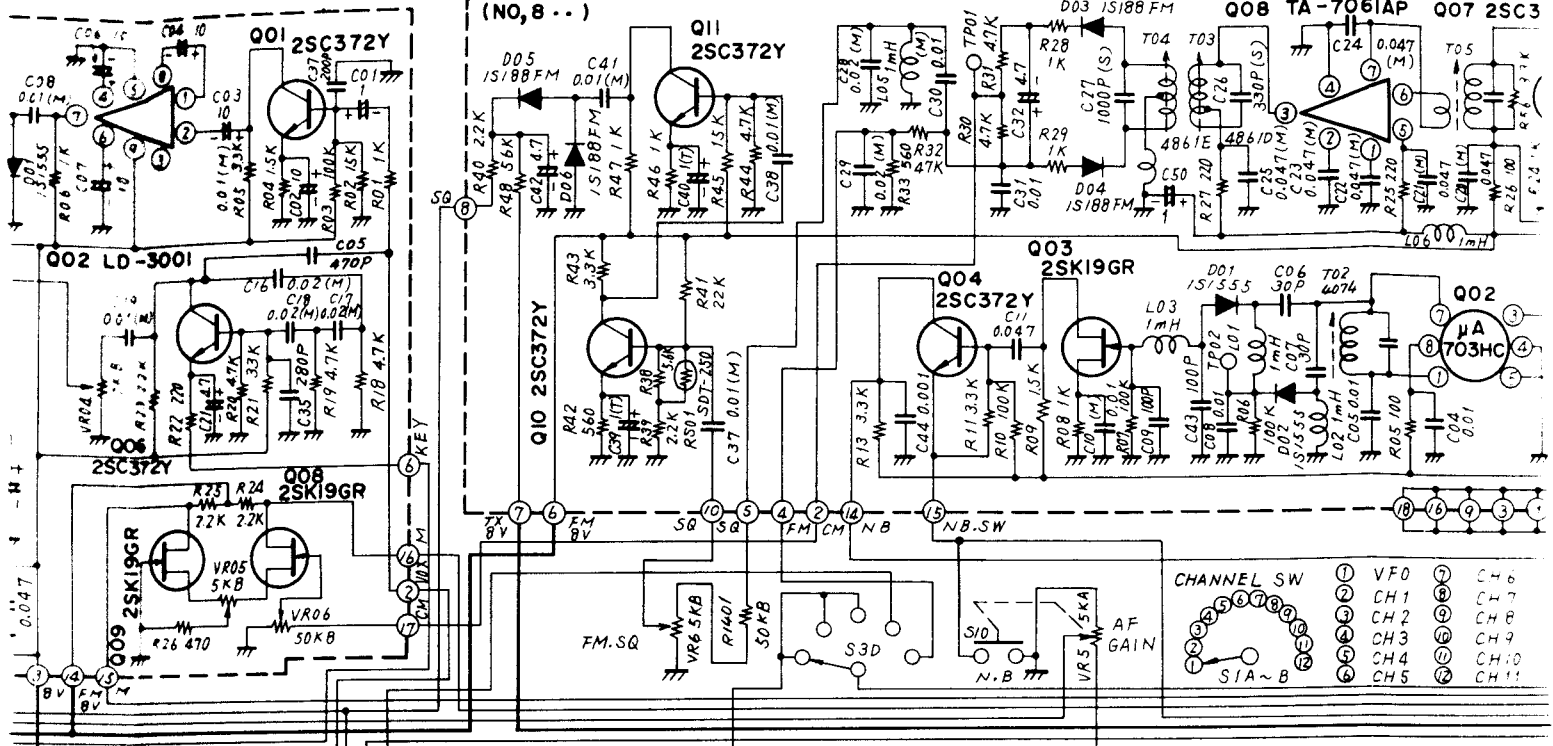

PB-1462(SSB IF)

(NO.9...)

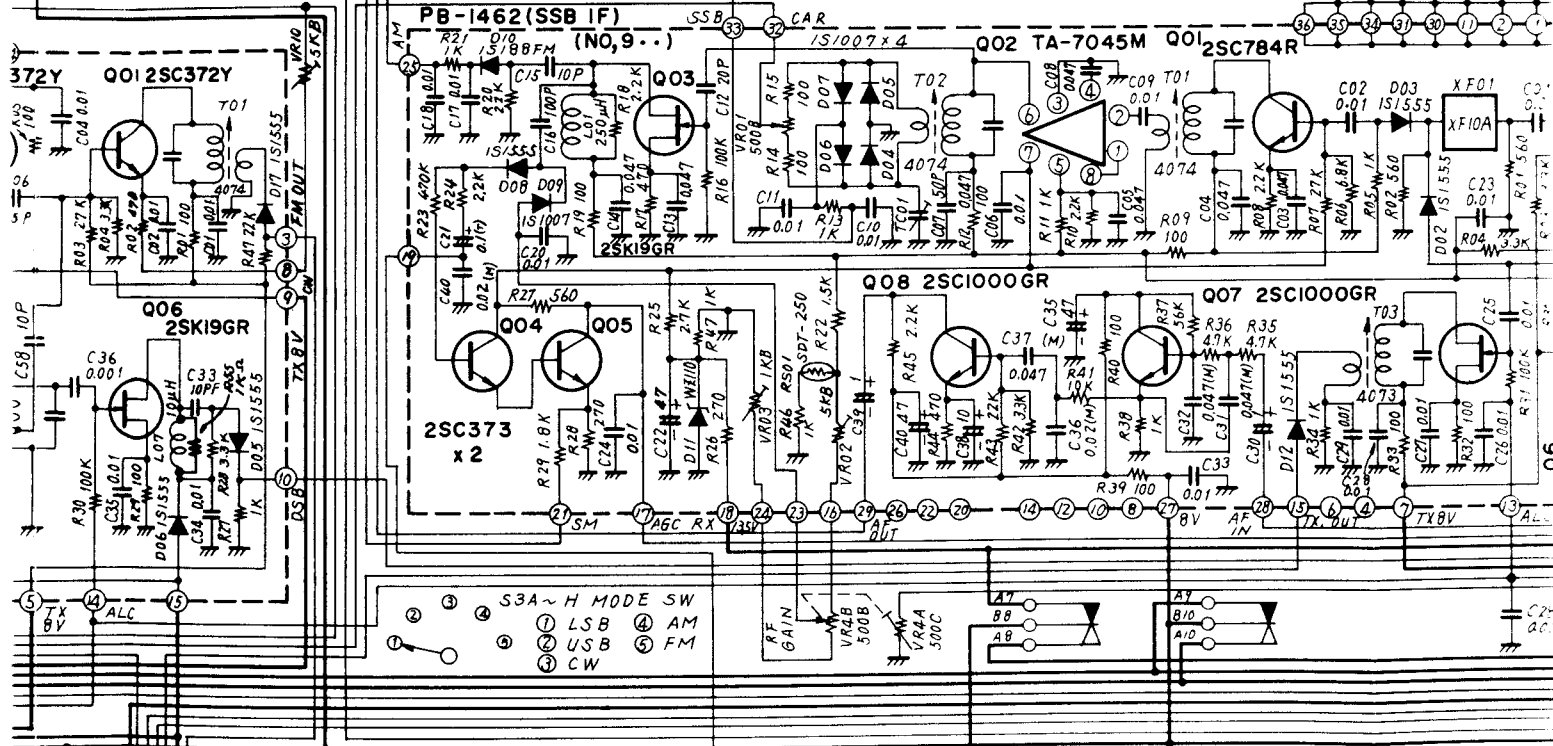

PB-1466(EXCITER)

(NO.5...)

