



MARK-V FT-1000MP *Field*

HF TRANSCEIVER

Operating Manual



VERTEX STANDARD CO., LTD.

4-8-8 Nakameguro, Meguro-Ku, Tokyo 153-8644, Japan

VERTEX STANDARD

US Headquarters

17210 Edwards Rd., Cerritos, CA 90703, U.S.A.

International Division

8350 N.W. 52nd Terrace, Suite 201, Miami, FL 33166, U.S.A.

YAESU EUROPE B.V.

P.O. Box 75525, 1118 ZN Schiphol, The Netherlands

YAESU UK LTD.

Unit 12, Sun Valley Business Park, Winnall Close
Winchester, Hampshire, SO23 0LB, U.K.

VERTEX STANDARD HK LTD.

Unit 5, 20/F., Seaview Centre, 139-141 Hoi Bun Road,
Kwun Tong, Kowloon, Hong Kong

Tabel of Contents

General Description	1	Using SUB VFO B	60
Specifications	3	Dual Reception	60
Plug/Connector Pinout Diagrams	4	Split Frequency Operation	62
Accessories & Options	5	Sideband Diversity Reception	63
Supplied Accessories	5	Bandwidth Diversity Reception	63
Available Options	6	VFO Tracking	63
Safety Precautions	7	Memory Features	64
Power Connections	7	Memory Structure	64
Ground Connections	7	Memory Programming	65
Electrical Shock Prevention	8	Copying VFO-A Data to Selected Memory	65
Antenna Precautions	8	Recalling & Operating on Memory Channels	66
RF Field Exposure Advisory & Electromagnetic Compatibility	8	Memory Tuning	66
General Setup	9	Copying a Selected Memory to VFO-A	67
Preliminary Inspection	9	Copying between Memories	67
Power Connections	9	Grouping Memories	67
Transceiver Location	9	Limiting Memory Group Operation	67
Grounding	9	QMB (Quick Memory Bank) Operation	68
Antenna Considerations	10	Scanning Features	69
Adjusting the Front Feet	10	VFO Scanning	69
Memory Backup	10	Memory Scanning	69
Accessory Installation	11	Memory Scan Skip	69
Linear Amplifier Interfacing	11	Memory "Masking"	70
Transverter Operation	14	Scan Resume Mode	70
Digital Modem (TNC, WeatherFax, etc.) Interfacing	15	Scan Skip Disable	70
Other Digital/Recording Device Interfacing	19	Programmed Memory Scanning (PMS Memories P1 ~ P9) ..	71
CW Key/Paddle and Computer Keying Interface suggestions ..	19	Advanced Features	72
Antenna Connections	20	EDSP	72
Personal Computer Interfacing for Contest Software, etc.	21	EDSP Functions	73
Front Panel Controls	22	EDSP RX Audio Enhancement	73
LCD Bargraph Meter Indications	30	EDSP Noise Reducer	74
Top Panel Access & Controls	32	EDSP APF (Audio Peak Filter)	74
Rear Panel Controls & Connectors	34	IDBT (Interlocked Digital Bandwidth Tracking) System	74
Operation	36	EDSP Auto Multiple Notch Filter	74
Before Starting	36	Remote Control Operation	76
MARK-V FT-1000MP <i>Field</i> Menu Programming	36	Introduction	76
Receiving	36	I. Contest Keyer Control	76
Amateur Band Selection	36	II. VFO/Memory Control	79
Mode Selection	37	III. MAIN VFO-A Control	79
Tuning the MARK-V FT-1000MP <i>Field</i>	38	IV. SUB VFO-B Control	79
Alternate VFO Operation ("Front & Rear" VFO)	40	User-Customized Operating Mode	80
VFO Selection & Receiver Muting	40	Optional DVS-2 Digital Voice Recorder	81
Keypad Frequency Entry	40	Overview	81
Signal Tuning Meter Indications	41	Installation	81
Expanded Tuning Scale	42	DVS-2 Controls	81
AM Synchronous Tuning	42	Message Recording (from MAIN or SUB Receiver Audio)	82
Sub-Display Modes Selection	42	Playback (on the Air of Recorded Receiver Audio)	82
General Coverage Reception	43	Message Recording (from Microphone Audio)	82
Dealing with Interference	44	Message Monitor (Playback Without Transmitting)	83
VRF (Variable RF Front-end Filter)	44	Message Transmission ("On the Air" Playback)	83
Front End Selections: Amp Selection, IPO & ATT	44	Phone Patch Operation	84
AGC (Automatic Gain Control) Selection	45	Tuning Meter Re-Calibration	85
Noise Blanker	46	CW Tuning	85
IF Filter (Bandwidth) Selection	46	RTTY Tuning	85
WIDTH Control	47	Packet Tuning	85
SHIFT Control	48	CAT System Computer Control	86
Notch Filter	48	Overview	86
Clarifier (Rx/Tx Offset Tuning)	49	CAT Data Protocol	86
Offset Display Mode	50	Constructing and Sending CAT Commands	87
Transmitting	51	Downloading MARK-V FT-1000MP <i>Field</i> Data	88
Selecting Antennas	51	Status Update Organization	88
Automatic Antenna Matching	51	Selecting Updata to Download	90
SSB Transmission	52	1-Byte Memory Channel Number Data Structure	90
Transmitter Monitor	52	16-Byte Data Record Structure	91
Microphone Tone Selection	53	Coding Examples	93
RF Speech Processor	53	Menu Selection and Setting	98
Class-A Operation	53	Installing Internal Accessories	112
VOX Operation	54	TCXO-Unit	112
CW Transmission	54	Main Receiver 2nd and 3rd IF Filters	113
Straight-Key Operation	54	Sub Receiver CW Narrow Filter	113
Electronic Keyer Operation	55	Miscellaneous	114
ACS (Auto Character Spacing)	53	Lithium Battery Replacement	114
Keyer Settings	56	Power-on Setting	115
CW Pitch Setting and Spot Tone	56	Changing the AC Input Voltage Selector Switch	116
AM Transmission	57		
Digital Mode Operation	57		
RTTY Operation	57		
Packet Operation	58		
1200-Baud FM Packet	58		
FM Transmission	59		

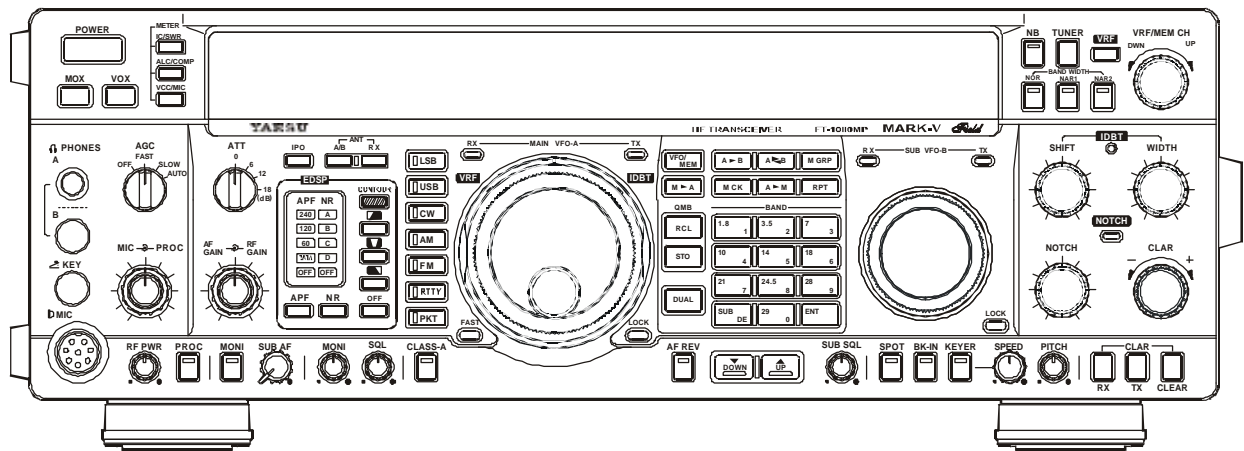

Congratulations on the purchase of your Yaesu amateur transceiver! Whether this is your first rig, or if Yaesu equipment is already the backbone of your station, rest assured that your transceiver will provide many hours of operating pleasure for years to come.

The **MARK-V FT-1000MP Field** is an elite-class HF transceiver providing exceptional performance both on transmit and receive. The **MARK-V FT-1000MP Field** is designed for the most competitive operating situations, whether you primarily operate in contest, DX, or digital-mode environments.

Built on the foundation of the popular MARK-V FT-1000MP transceiver, the **MARK-V FT-1000MP Field** provides up to 100 Watts of power output on SSB, CW, and FM (25 Watts AM carrier). Additionally, a Yaesu-exclusive “**Class-A**” SSB operating mode provides ultra-linear signal output, at a power output level of up to 25 Watts.

Also new on the **MARK-V FT-1000MP Field** is the **IDBT (Interlocked Digital Bandwidth Tracking) System**, which automatically aligns the bandwidth of the **Enhanced Digital Signal Processing (EDSP)** receiver passband to match the IF filter passband. This improves operating efficiency by removing the extra step of making separate analog and DSP filter adjustments. This feature can be enabled or disabled with the press of a button, for maximum flexibility.

And for exceptional protection from strong nearby incoming signals, Yaesu-exclusive **VRF (Variable RF Front-End Filter)** serves as a high-performance Preselector-ideal for multi-operator contest environments. This filter is manually tuned, allowing the operator to optimize sensitivity or signal rejection with the twist of a knob.

In addition to the contribution of the **VRF** Preselector, superb receiver performance is a result of direct lineage from the legendary FT-1000D and FT-1000MP. New technology Direct Digital Synthesizers (two 10-bit and three 8-bit) are used in the local oscillator (all driven by a single TCXO master oscillator), resulting in extremely fine tuning resolution with thirteen selectable tuning steps down to 0.625 Hz. You may select either “Flat” or “Tuned” front end RF amplification (using four FETs in a double push-pull, constant-gain stage), **IPO (Intercept Point Optimization)** utilizing direct feed to the first mixer, and/or three levels of RF attenuation in 6-dB steps. The “Tuned” RF Preamplifier provides high gain and low noise figure on the higher frequency bands, with lower gain and greater selectivity on the low bands, where strong-signal performance is critically important.

To battle QRM, the **MARK-V FT-1000MP Field** comes equipped with a formidable defense. Fine tailoring of the IF passband is made possible with individually-selected, cascaded 2nd- and 3rd-IF crystal filter banks. World-renowned Collins® mechanical 500-Hz CW filters are available as options for the Sub Receiver 2nd IF, and main receiver 3rd IF strip. An IF notch filter and concentric IF Shift and Width controls are also provided. The IF Width circuit allows continuously narrowing receiver passband by selectively moving either the upper or lower filter skirt just as much as needed to reduce QRM while still preserving the maximum usable bandwidth. This extensive analog IF filtering protects the EDSP circuits that follow it, ensuring unmatched performance during crowded band conditions.

GENERAL DESCRIPTION

Yaesu's **Enhanced Digital Signal Processing (EDSP)** circuitry, pioneered in the FT-1000MP, provides a wide array of interference-rejection and signal-customization features. On receive, three different signal "Contour" enhancements, in addition to narrow-bandwidth peaking filters for CW and Data modes, help dig out weak signals from the noise. Combined with the EDSP Auto-Notch and Noise Reduction circuits, the IF analog filters and EDSP response Contours are without peer in the Amateur Radio industry for signal enhancement. On transmit, the EDSP Microphone Equalizer allows matching of the transmitter's audio response to your voice's pattern, thereby maximizing useful power output in the SSB envelope.

Advanced features include Dual Receive, Direct Keyboard Frequency Entry and Band Change, RF Speech Processor, RF Monitor for Voice modes, CW Pitch control, CW Spot switch, Full CW QSK, adjustable IF Noise Blanker, Synchronous Tuning for AM, and all-mode Squelch. And the Yaesu-exclusive **Shuttle-Jog** tuning ring provides a spring-loaded manual scanning tool, perfect for sweeping across a band as you take a quick look for activity.

Frequency setup is extraordinarily simple on the **MARK-V FT-1000MP Field**. Besides direct frequency entry for both the Main and Sub VFOs, separate keys are provided for band selection, and each band key accesses two independent VFO frequency/mode/filter settings per band, so you can establish separate VFO settings for two different parts of each band. The Sub VFO has its own banks of VFOs for each band, and you may copy frequencies from the Main to the Sub VFO, or swap frequencies between the two, with a single button push. The two VFOs allow simultaneous reception and display of two different frequencies, even in different modes and with different IF bandwidths. Receiver audio can be completely or partially mixed, or monitored separately in each ear.

In addition, 99 scannable memories are provided, each of which stores its own mode and IF filter selection, in addition to frequency, Clarifier offset, and skip status. What's more, five quick-recall ("QMB") memories can instantly store operational settings at the push of a button.

The built-in automatic antenna tuner includes 39 memories of its own, automatically storing antenna matching settings for quick automatic recall later.

A unique feature of the **MARK-V FT-1000MP Field** is the rear panel's "REMOTE" jack, a multi-featured port which allows a number of possible control functions. When connected to the optional **FH-1** Keypad (or a home-made keypad), the REMOTE jack may be used as a control pad for the contest message keyer, or for memory/VFO control of the Main or Sub receiver.

Interfacing for digital modes is extremely simple with the **MARK-V FT-1000MP Field**, thanks to dedicated AFSK and FSK connection jacks on the rear panel. Optimization of the filter passbands, EDSP settings, carrier insertion point, and display offset are all possible via the Menu programming system.

The Yaesu **CAT** system provides a direct link to the transceiver CPU for computer control and customization of tuning, scanning and other operating functions. The **MARK-V FT-1000MP Field** includes a built-in data level converter for direction connection to a personal computer serial port. Yaesu products are supported by most all of the leading contest and DX logging programs, and the programming protocol is included in this manual, if you wish to write your own software!

Special options for the **MARK-V FT-1000MP Field** include the **TCXO-6** Temperature Compensated Crystal Oscillator module, and a wide selection of IF filters to complement the four already installed as standard. External options include the **DVS-2** Digital Voice Recorder; **SP-8** External Loudspeaker with optional **LL-7** Phone Patch module; **YH-77STA** Stereo Headset; **FH-1** Remote Control Keypad; **MD-100A8X** Desktop Microphone; and the **MD-200A8X** Ultra-High-Fidelity Desktop Microphone. Rounding out your Yaesu station, the **VL-1000** 1 KW Linear Amplifier is specifically designed to match your **MARK-V FT-1000MP Field**, providing the convenience of fully automatic band change along with 1000 Watts of clean power output.

Advanced technology is only part of the **MARK-V FT-1000MP Field** story. Vertex Standard stands behind our products with a worldwide network of dealers and service centers. We greatly appreciate your investment in the **MARK-V FT-1000MP Field**, and we look forward to helping you get the most out of your new transceiver. Please feel free to contact your nearest dealer, or one of Vertex Standard's national headquarters offices, for technical advice, interfacing assistance, or accessory recommendation. And watch Vertex Standard U.S.A.'s Home Page for late-breaking information about Vertex Standard products: <http://www.vxstd.com>.

Please read this manual thoroughly, so as to gain maximum understanding of the full capability of the **MARK-V FT-1000MP Field**, simply the finest Amateur Radio transceiver available today!

General

Rx Frequency Range:	100 kHz - 30 MHz
Tx Frequency Ranges:	160 - 10m (Amateur bands only)
Frequency Stability:	±0.5 ppm (after 1 min. @ 25 °C) ±0.25 ppm (after 1 min. @ 25 °C, w/TCXO-6)
Operating Temperature Range:	-10 °C ~ +50 °C
Emission Modes:	LSB, USB, CW, FSK, AFSK, AM, FM
Frequency Steps:	0.625/1.25/2.5/5/10 Hz for SSB,CW, RTTY & Packet; 100 Hz for AM and FM
Antenna Impedance:	50 Ohms, unbalanced 16.6 - 150 Ohms, unbalanced (Tuner ON, TX only)
Power Consumption(@ 13.8 V DC):	Rx (no signal) 2.3 A Rx (signal) 2.7 A Tx (100 W) 20 A
Supply Voltage:	13.8 VDC/100-120 VAC 50-60 Hz/200-240 VAC 50-60 Hz
Dimensions (WHD):	410 x 135 x 347 mm (16 x 5.3 x 13.7 inch)
Weight (approx.):	15 kg. (33 lbs)

Transmitter





Power Output:	Adjustable up to 100 watts (25 watts AM carrier), Class A mode (SSB): 25 watts maximum
Duty Cycle:	100% @ 50 watts, 50% @ 100 watts (FM & RTTY, 3-minute Tx)
Modulation Types:	SSB: J3E Balanced, AM: A3E Low-level (early stage), FM: F3E Variable reactance, AFSK: J1D, J2D Audio frequency shift keying
Maximum FM Deviation:	± 2.5 kHz
FSK Shift Frequencies:	170, 425, and 850 Hz
Packet Shift Frequencies:	200 and 1000 Hz
Harmonic Radiation:	Better than -60 dB (Typical)
SSB Carrier Suppression:	At least 40 dB below peak output
Undesired Sideband Suppression:	At least 55 dB below peak output
Audio Response (SSB):	Not more than -6 dB from 400 to 2600 Hz
3rd-order IMD:	-31 dB @ 100 watts PEP, or better Class A mode: -40 dB @ 25 watts PEP (Typical)
Microphone Impedance:	500 to 600 Ohms

Receiver

Circuit Type:	Quad-conversion superheterodyne (triple conversion for FM)			
Intermediate Frequencies:	Main Rx; 70.455 MHz/8.215 MHz/455 kHz, Sub Rx; 47.21 MHz/455 kHz			
Sensitivity:	Modes	0.5 - 1.8 MHz	1.8 - 30 MHz	
	SSB/CW (2.0 kHz)	2 µV	0.16 µV	
	AM (6 kHz)	13 µV	2 µV	
	FM	-	0.5 µV	
	(with preamp on, IDBT on, SSB/CW/AM for 10 dB S/N, FM for 12 dB SINAD, 0 dBµ = 1 µV)			
Selectivity (-6/-60 dB):	Band Width	Modes	Minimum -6 dB BW	Maximum -60 dB BW
	2.4 kHz	all except FM	2.2 kHz	4.2 kHz
	2.0 kHz	all except FM	1.8 kHz	3.6 kHz
	500 Hz	CW/RTTY/Packet	500 Hz	1.8 kHz
	250 Hz	CW/RTTY/Packet	250 Hz	700 Hz
		AM (Wide)	4 kHz	14 kHz
		FM	8 kHz	19 kHz
IF Rejection (1.8 ~ 30 MHz):	80 dB or better (Main Rx), 60 dB or better (Sub Rx)			
Image Rejection (1.8 ~ 30 MHz):	80 dB or better (Main), 50 dB or better (Sub)			
Maximum Audio Output:	2.0 W into 4 Ohms with <10% THD			
Audio Output Impedance:	4 to 8 Ohms			

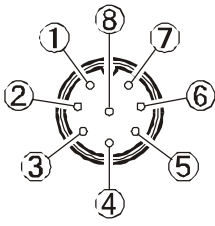
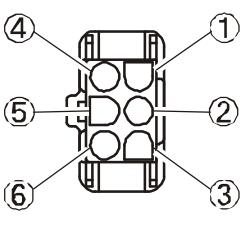
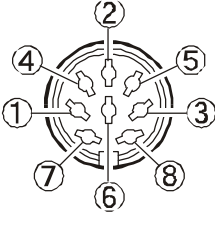
Specifications are subject to change, in the interest of technical improvement, without notice or obligation.

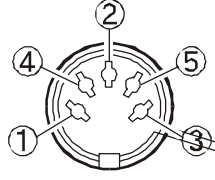
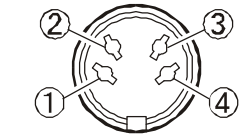
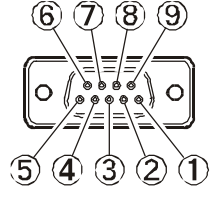
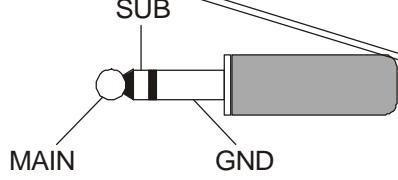
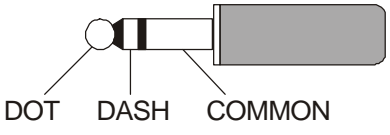
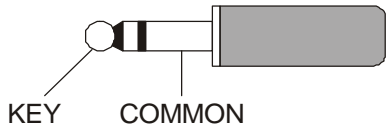
PLUG/CONNECTOR PINOUT DIAGRAMS

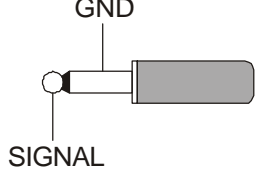
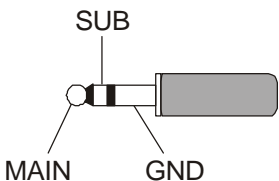
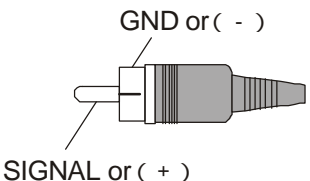
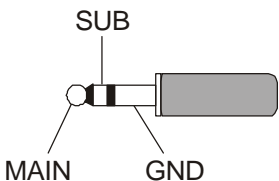
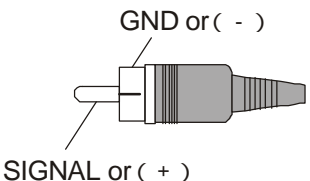
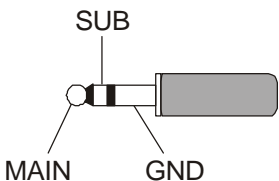
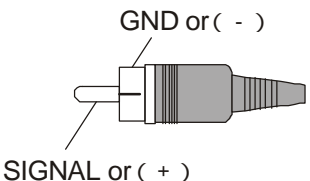
<p style="text-align: center;">MIC</p>  <p>(as viewed from front panel)</p> <ul style="list-style-type: none"> ① UP ② +5V ③ DOWN ④ FAST ⑤ GND ⑥ PTT ⑦ MIC GND ⑧ MIC 	<p style="text-align: center;">DC IN</p>  <p>(as viewed from rear panel)</p> <ul style="list-style-type: none"> ① +13.8 V ② GND ③ N/A ④ +13.8 V ⑤ GND ⑥ N/A 				
<p style="text-align: center;">BAND DATA</p>  <p>(as viewed from rear panel)</p> <ul style="list-style-type: none"> ① +13V ② TX GND ③ GND ④ BAND DATA A ⑤ BAND DATA B ⑥ BAND DATA C ⑦ BAND DATA D ⑧ LINEAR 	<p style="text-align: center;">DVS-2</p>  <p>(as viewed from rear panel)</p> <ul style="list-style-type: none"> ① VOICE IN ② VOICE OUT ③ PTT ④ +9V ⑤ CNTL 1 ⑥ CNTL 2 ⑦ GND 				
<p style="text-align: center;">PACKET</p> <p>Use this jack for AFSK digita-mode connections</p>  <p>(as viewed from rear panel)</p> <ul style="list-style-type: none"> ① DATA IN ② GND ③ PTT ④ DATA OUT ⑤ BUSY 	<p style="text-align: center;">RTTY</p> <p>Use this jack for FSK RTTY connections</p>  <p>(as viewed from rear panel)</p> <ul style="list-style-type: none"> ① SHIFT ② RX OUT ③ PTT ④ GND 				
<p style="text-align: center;">CAT</p>  <p>(as viewed from rear panel)</p> <ul style="list-style-type: none"> ① NC ② SERIAL OUT ③ SERIAL IN ④ N/A ⑤ GND ⑥ N/A ⑦ N/A ⑧ N/A ⑨ NC 	<p style="text-align: center;">PHONE</p> 				
<p style="text-align: center;">KEY</p> <p>Internal Keyer</p>  <p>Straight Key</p>  <p> Do not use 2-conductor type plug</p>	<p style="text-align: center;">REMOTE/EXT SPKR</p>  <table border="1" style="width: 100%; border-collapse: collapse;"> <thead> <tr> <th style="text-align: center; padding: 5px;">AF OUT</th> <th style="text-align: center; padding: 5px;">RCA PLUG</th> </tr> </thead> <tbody> <tr> <td style="text-align: center; padding: 5px;">  </td> <td style="text-align: center; padding: 5px;">  </td> </tr> </tbody> </table>	AF OUT	RCA PLUG		
AF OUT	RCA PLUG				
					

SUPPLIED ACCESSORIES

Hand Microphone MH-31B8 (depending on transceiver version)	1
AC Power Cord (T9013282 for 100 - 120 V or T9013285 for 200 - 240 V)	1
Spare Fuse (8-A [Q0000104] for 100 - 120 V or 4-A [Q0000103] for 200 - 240 V)	1
RCA Plug (P0090544)	1
¼-inch 3-contact Plug (P0090008)	1
3.5 mm 2-contact Plug (P0090034)	1
3.5 mm 3-contact Plug (P0091046)	1
4-pin DIN Plug (P0091004)	1
5-pin DIN Plug (P0091006)	1
Operating Manual	1
Warranty Card	1

AVAILABLE OPTIONS

TCXO-6 HIGH-STABILITY MASTER REFERENCE OSCILLATOR

For special applications and environments where extra frequency stability is essential, such as for long-term HF packet monitoring under wide temperature variations, the **TCXO-6** provides ± 0.25 -ppm stability the master reference oscillator (after 1 min. @ 25 °C).

MD-100A8X DESK-TOP MICROPHONE

Designed especially to match the electrical and cosmetic features of the **MARK-V FT-1000MP Field**, the **MD-100A8x** has a 600 Ohm impedance, and includes an up/down scanning ring and a large PTT switch with latch.

MD-200A8X

ULTRA-HIGH-FIDELITY DESK-TOP MICROPHONE

Designed especially to match the electrical and cosmetic features of the **MARK-V FT-1000MP Field**, the **MD-200A8x** includes a new-technology "Variable Side Pressure Control" (**VSPC**), which allows precise adjustment of the microphone's audio response without resorting to "active" equalization circuits that can introduce distortion and/or degrade signal-to-noise ratio.

VL-1000 LINEAR AMPLIFIER

The **VL-1000** is an all-solid-state linear amplifier operating on the 160 through 6 meter amateur bands (USA version: 160-15 meters) at a power output level of 1000 Watts on CW and SSB (500 Watts on continuous data modes such as RTTY). The **VL-1000** includes a built-in antenna tuner with 240 memories for tuning data, and microprocessor control of the tuning circuitry.

The **VL-1000** features input jacks for two different exciters, as well as four antenna jacks for connection of antennas for different bands. Extensive self-test, system monitoring, and protection circuits are provided, with status and tuning information being displayed on a huge Liquid Crystal Display panel.

The companion **VP-1000** AC Power Supply provides the necessary voltages for the 48-Volt PA section of the **VL-1000**.

FTV-1000 50 MHz TRANSVERTER & FRB-5 RELAY UNIT

The **FTV-1000** is a high-performance, high-power 50-54 MHz transverter compatible with the **MARK-V FT-1000MP Field**. Providing excellent receiver performance and up to 200 Watts of power output, the **FTV-1000** is specifically designed for the demanding requirements of 50 MHz DX operators. Among the leading-edge features of the **FTV-1000** is a Class-A operating bias selection for the transmitter's power amplifier stage; during Class-A operation, power output is reduced to 50 Watts, and the high bias current leads to an extraordinarily clean SSB wave-form, with 5th-order intermodulation (IMD) typically suppressed by at least 65 dB.

Besides this unit, you must also purchase the **FP-29** AC Power Supply and **FRB-5** Relay Unit, available from your Yaesu dealer.

The **FRB-5** Relay Unit allows interconnection and operation of the **FTV-1000** with the **MARK-V FT-1000MP Field** Transceiver.

SP-8 LOUDSPEAKER WITH AUDIO FILTERS & LL-7 PHONE PATCH OPTION

Selectable audio high- and low-pass filters together with a large loudspeaker complement the superb audio characteristics of the **MARK-V FT-1000MP Field** with your choice of 12 different audio filtering combinations. Two input terminals are provided for multiple transceivers, with a front panel switch to select between them. A (monaural) phone jack is provided on the front panel to take advantage of the audio filters with headphones.

With the optional **LL-7** Phone Patch Unit installed in the **SP-8**, the **MARK-V FT-1000MP Field** can be patched to the public telephone network. The **LL-7** includes a hybrid transformer circuit to assure proper impedance matches, and front panel gain controls and level meter to set proper audio levels on the telephone line.

AVAILABLE OPTIONS

YH-77STA LIGHTWEIGHT STEREO HEADPHONES

Dual samarium-cobalt transducers with sensitivity of 103dB/mW (± 2 dB, @1 kHz, 35 Ohms) provide the perfect match for the **MARK-V FT-1000MP Field**. During dual receive with the **YH-77STA**, one receiver can be monitored in each ear, allowing easy separation of the signals from the two receivers (or the audio can be mixed, if desired).

DVS-2 DIGITAL VOICE RECORDER

Serving as either a continuous receiver recorder for instant pushbutton playback, or microphone audio recorder for multiple on-air playback, the **DVS-2** applies the advantages of random-access solid-state digital memory to serious communications. All data is stored electronically, with no moving parts except your finger and the pushbutton. More information is on page 81.

FH-1 REMOTE CONTROL KEYPAD

The **FH-1** is a remote-control accessory designed to enhance the operating flexibility of your **MARK-V FT-1000MP Field**. The **FH-1** permits several remote control features, which may be selected via Menu programming. More information is on page 76.

IF Crystal Filter Options

Five optional crystal filters may be installed in the Main Receiver of the **MARK-V FT-1000MP Field**, and one in the Sub Receiver.

Optional Main Receiver Filters

8.2 MHz (2nd IF)

YF-114SN: 2.0-kHz BW (for all modes except FM)

YF-114CN: 250-Hz BW (for all except AM & FM)

455 kHz (3rd IF)

YF-110SN: 2.0-kHz BW (for all modes except FM)

YF-115C Collins Mechanical Filter: 500-Hz BW (for CW & RTTY)

YF-110CN: 250-Hz BW (for CW only)

Optional Sub Receiver Filter

455 kHz (2nd IF)

YF-115C: Collins Mechanical Filter 500-Hz BW (for CW & RTTY)

Availability of accessories may vary: some accessories are supplied as standard per local regulations and requirements, others may be unavailable in some regions. Check with your Yaesu dealer for additions to the above list.

Before initiating the installation of your **MARK-V FT-1000MP Field** transceiver, please take the time to review the following safety guidelines.

POWER CONNECTIONS

The **MARK-V FT-1000MP Field** can be operated from either AC or DC power sources.

When making AC connections to your house wiring, be certain that the voltage at the AC wall outlet matches the voltage label on the rear panel of the transceiver.

If you are connecting to a 13.8 Volt DC source, use the optional **E-DC-20** DC Power Cable, and be certain to observe the proper polarity when connecting to your DC power supply. Connect the **RED** power cable lead to the **POSITIVE (+)** terminal of the DC source, and the **BLACK** power cable lead to the **NEGATIVE (-)** terminal.

GROUND CONNECTIONS

The **MARK-V FT-1000MP Field** HF transceiver, like any other HF communications apparatus, requires an effective ground system for maximum electrical safety and best communications effectiveness. A good ground system can contribute to station efficiency in a number of ways:

- ❑ It can minimize the possibility of electrical shock to the operator.
- ❑ It can minimize RF currents flowing on the shield of the coaxial cable and the chassis of the transceiver; such currents may lead to radiation which can cause interference to home entertainment devices or laboratory test equipment.
- ❑ It can minimize the possibility of erratic transceiver/accessory operation caused by RF feedback and/or improper current flow through logic devices.

An effective earth ground system make take several forms; for a more complete discussion, see an appropriate RF engineering text. The information below is intended only as a guideline.

Typically, the ground connection consists of one or more copper-clad steel rods, driven into the ground. If multiple ground rods are used, they should be positioned in a "V" configuration, and bonded together at the apex of the "V" which is nearest the station location. Use a heavy, braided cable (such as the discarded shield from type RG-213 coaxial cable) and strong cable clamps to secure the braided cable(s) to the ground rods. Be sure to weatherproof the connections to ensure many years of reliable service. Use the same type of heavy, braided cable for the connections to the station ground bus (described below).

Inside the station, a common ground bus consisting of a copper pipe of at least 25 mm (1") diameter should be used. An alternative station ground bus may consist of a wide copper plate (single-sided circuit board material is ideal) secured to the bottom of the operating desk. Grounding connections from individual devices such as transceivers, power supplies, and data communications devices (TNCs, etc.) should be made directly to the ground bus using a heavy, braided cable.

Do not make ground connections from one electrical device to another, and thence to the ground bus. This so-called "Daisy-Chain" grounding technique may nullify any attempt at effective radio frequency grounding. See the drawing below for examples of proper grounding techniques.

Inspect the ground system – inside the station as well as outside – on a regular basis so as to ensure maximum performance and safety.

Besides following the above guidelines carefully, note that household or industrial gas lines must **never** be used in an attempt to establish an electrical ground. Cold water pipes may, in some instances, help in the grounding effort, but gas lines represent a significant explosion hazard, and must never be used.

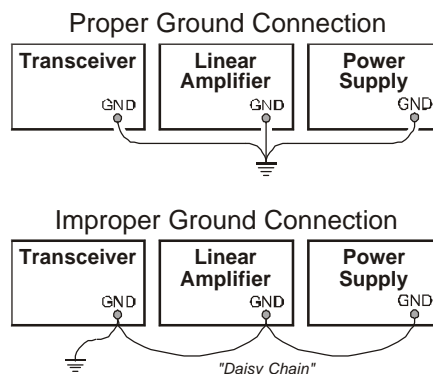

SAFETY PRECAUTIONS

ELECTRICAL SHOCK PREVENTION

Be certain that all station wiring is properly insulated so as to prevent short-circuits which could damage this transceiver and/or accessories connected to it. Be sure to protect power cables from damage due to abrasion by ensuring that they cannot be walked upon nor crushed under rolling chairs, etc. Never route power cables near sharp metallic edges which might cut through protective insulation.

Never spill liquids into this transceiver, and do not drop sharp metallic objects into the transceiver enclosure. Electrical shock may result when you attempt to remove the object.

Unsupervised children should be kept away from any electrical apparatus such as the **MARK-V FT-1000MP Field** transceiver and its accessories.

ANTENNA PRECAUTIONS

Always install antennas such that they can *never* come in contact with outdoor power lines in the event of a catastrophic antenna support or power line support structure failure. An adequate safety margin is *usually* provided by separating power lines from the antenna and its support structure [1.5 times the height of the support] *plus* [the length of any antenna or guy wires attached to the support] *plus* [the height of the power line support pole].

Ground the antenna support structure adequately, so as to dissipate energy absorbed during a lightning strike. Install appropriate lightning arrestors in the antenna lead-in and rotator cable (if used) according to the arrestor's instructions.

In the event of an approaching electrical storm, disconnect all antenna lead-in, rotator control, and power cables *completely* from the station, **but only if the storm is not immediately in your area**. Do not allow disconnected cables to touch the case of your **MARK-V FT-1000MP Field** transceiver or accessories, as lightning can easily jump from the cable to the circuitry of your transceiver via the case, causing irreparable damage. If a lightning storm *is* in progress in your immediate area, *do not* attempt to disconnect the cables, as you could be killed instantly should lightning strike your antenna, tower, or a nearby power line.

If a vertical antenna is used, be certain that humans and/or pets or farm animals are kept away both from the radiating element (to prevent electrical shock and RF exposure danger) *and* the ground system (in the event of an electrical storm). The buried radials of a ground-mounted vertical antenna can carry lethal voltages outward from the center of the antenna in the event of a direct lightning strike.

RF FIELD EXPOSURE ADVISORY & ELECTROMAGNETIC COMPATIBILITY

This transceiver is capable of power output in excess of 50 Watts, so customers in the United States may be required to demonstrate compliance with Federal Communications Commission (FCC) regulations concerning maximum permissible exposure to radio frequency energy. Compliance is based on the actual power output used, feedline loss, antenna type and height, and other factors which can only be evaluated as a system. Information regarding these regulations may be available from your Dealer, your local radio club, from the FCC directly (press releases and other information can be found on the FCC's site on the World Wide Web at <<http://www.fcc.gov>>), or from the American Radio Relay League, Inc. (225 Main St., Newington CT 06111 or <<http://www.arrl.org>>).

Remember to re-evaluate your station's compliance with these regulations during portable operations such as Field Day or special-event stations.

Regarding electromagnetic compatibility: if this transceiver is used with, or in the vicinity of, a computer or computer-driven accessories, you may need to experiment with grounding and/or Radio Frequency Interference (RFI) suppression devices (such as ferrite cores) to minimize interference to *your* communications caused by energy from the computer. Computer-generated RFI is usually a result of inadequate shielding of the computer's cabinet or I/O and peripheral connections. While computer equipment may "comply" with RF emission standards, this does *not* ensure that sensitive amateur radio receivers will not experience interference from the device!

Be certain to use only shielded cables for TNC-to-Transceiver connections. You may need to install AC line filters on the power cord(s) of the suspected equipment, and decoupling ferrite toroidal chokes may be required on interconnecting patch/data cables. As a last resort, you can try installing additional shielding within the computer's case, using appropriate conductive mesh or conductive shielding tape. Especially check "RF holes" where plastic is used for cabinet front panels.

For further information, consult amateur radio reference guides and publications relating to RFI suppression techniques.

PRELIMINARY INSPECTION

Inspect the transceiver upon opening the packing carton. Check that all controls and switches work freely, and inspect the cabinet for any damage. Ensure the accessory fuses and plugs pictured on page 4 are included. If any damage is found, document it completely, and contact the shipping company (or dealer, if you purchased it over-the-counter) right away. Save the packing materials in case you need to return the set for service. If you have purchased optional internal accessories separately, install them as described on page 112.

POWER CONNECTIONS

Before connecting AC power, check the label on the rear panel which indicates the AC mains voltage for which your transceiver is currently set. If the voltage on this label does not match your AC mains voltage, a switch on the internal power supply in the transceiver must be moved, and the fuse must be changed (U.S.A. users only). See page 116 for more information and details.

After making certain the AC voltage for which the transceiver is set matches your mains voltage, and that the correct fuse is installed in the fuse holder, connect the supplied AC power cord between the 3-pin **-AC IN** jack on the rear panel and the AC wall outlet.

The **MARK-V FT-1000MP Field** can also be operated from 13.8 Volts DC, negative ground, with any well-regulated DC source being capable of providing 22 Amperes of continuous current.

If you are connecting to a DC source, use the optional **E-DC-20** DC Power Cable (with 25-A fuse). Connect the **RED** power cable lead to the **POSITIVE (+)** terminal of the DC source, and the **BLACK** power cable lead to the **NEGATIVE (-)** terminal, then connect the DC plug from the **E-DC-20** to the **DC IN** jack on the rear panel.

Warning: Our warranty does not cover damage caused by improper supply voltage nor use of an improper fuse.

NOTE

If you have both AC and DC power sources connected at the same time, the **MARK-V FT-1000MP Field** will automatically select the external DC supply as its power source.

TRANSCEIVER LOCATION

To assure long life of the components, a primary consideration in setting up the **MARK-V FT-1000MP Field** is providing for adequate ventilation around the cabinet. The cooling system of the **MARK-V FT-1000MP Field** must be free to draw cool air in at the lower rear of the transceiver, and to expel warm air out of the upper rear panel. Do not place the transceiver on top of another heat-generating device such as a linear amplifier, and do not place equipment, books or papers on top of the transceiver. Also, provide a few centimeters of space on either side of the transceiver, if possible. Avoid heating vents and window locations that could expose the transceiver to excessive direct sunlight, especially in hot climates.

GROUNDING

For protection from electrical shock, and to ensure proper performance, connect the **GND** terminal on the rear panel to a good earth ground, using a heavy braided cable of the shortest length possible. All other station equipment should be connected to the same grounding cable, as close together as practical. If you use a computer with or near the **MARK-V FT-1000MP Field**, you may need to experiment with ground wiring to suppress computer noise in the receiver, and ground loops during transmission.

ANTENNA CONSIDERATIONS

The **MARK-V FT-1000MP Field** is designed for use with any antenna system providing a 50 Ω resistive impedance at the desired operating frequency. While minor excursions from the 50 Ω specification are of no consequence, the transceiver's Automatic Antenna Tuner may not be able to reduce the impedance mismatch to an acceptable value if the Standing Wave Ratio (SWR) present at the Antenna jack is greater than 3:1. Among the undesirable consequences that high SWR may produce are:

- ❑ The transceiver's power amplifier protection circuitry will reduce power if the Automatic Antenna Tuner is unsuccessful in reducing the SWR.
- ❑ Even if the Automatic Antenna Tuner successfully normalizes the impedance presented to the radio, feedline losses will escalate rapidly with increasing SWR at the higher operating frequencies, especially 28 MHz.
- ❑ Although high SWR itself does not cause feedline radiation, the sudden onset of high SWR may well indicate a mechanical failure in a matching device, leading to an electrical condition which *may* cause excessive feedline radiation, which can cause interference to nearby home-entertainment devices.

Every effort should, therefore, be made to ensure that the impedance of the antenna system utilized with the **MARK-V FT-1000MP Field** be as close as possible to the specified 50 Ω value.

Any antenna to be used with the **MARK-V FT-1000MP Field** must, ultimately, be fed with 50 Ω coaxial cable. Therefore, when using a "balanced" antenna such as a dipole, remember that a balun or other matching/balancing device must be used so as to ensure proper antenna performance.

The same precautions apply to any additional (receive-only) antennas connected to the **RXANT** jack; if your receive-only antennas do not have an impedance near 50 Ω at the operating frequency, you may need to install an external antenna tuner to obtain optimum performance.

Use high-quality 50 Ω coaxial cable for the lead-in to your **MARK-V FT-1000MP Field** transceiver. All efforts at providing an efficient antenna system will be wasted if poor quality, lossy coaxial cable is used. Losses in coaxial lines increase as the frequency increases, so a coaxial line with only 0.5 dB of loss at 7 MHz may have 2 dB of loss at 28 MHz. For reference, the chart in the next column shows approximate loss figures for typically-available coaxial cables frequently used in amateur radio installations.

Loss in dB per 30m (100 feet)
for Selected 50 Ω Coaxial Cables
(Assumes 50 Ω Input/Output Terminations)

Cable Type	Loss: 2 MHz	Loss: 15 MHz	Loss: 28 MHz
RG-58A	0.55	1.75	2.60
RG-58 Foam	0.54	1.50	2.00
RG-8X	0.39	1.07	1.85
RG-8A, RG-213	0.27	0.85	1.25
RG-8 Foam	0.22	0.65	0.88
Belden® 9913	0.18	0.50	0.69
RG-17A	0.88	0.30	0.46

Loss figures are approximate; consult cable manufacturers' catalogs for complete specifications.

Loss figures can increase significantly if high SWR is present on the transmission line.

ADJUSTING THE FRONT FEET

The two front feet of the **MARK-V FT-1000MP Field** can be set in either of two positions. By turning the knurled ring around a (retracted) foot clockwise, the middle of the foot will extend about one centimeter. Turn the ring as far as it will go (about ¼-turn) to lock the extended foot in place. To retract an extended foot, turn the knurled ring counterclockwise ¼-turn while pressing on the center of the foot.

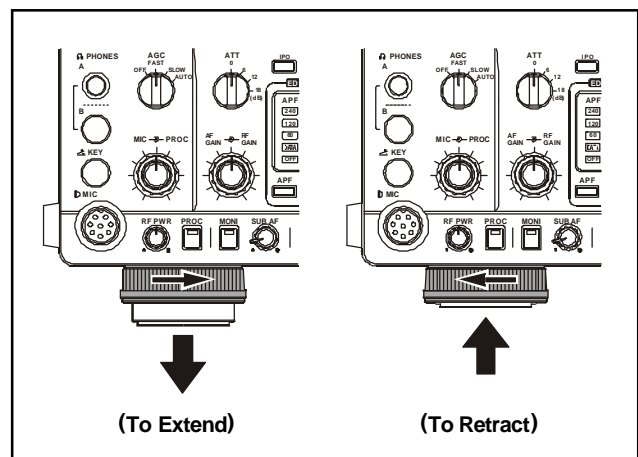

MEMORY BACKUP

The memory **BACKUP** switch on the rear panel is turned on at the factory, allowing VFO and memory data to be retained while power is off. Backup current is miniscule, so it is not necessary to turn the **BACKUP** switch off unless the transceiver is to be stored for an extended period.

After five or more years of operation the transceiver may fail to retain memories, at which time the lithium battery should be replaced. Contact your dealer for replacement of the battery; for instructions on how to do so yourself, see page 114.

LINEAR AMPLIFIER INTERFACING

The **MARK-V FT-1000MP Field** can be used with the optional Yaesu **FL-7000** or **VL-1000** Linear Amplifier, providing automatic band switching via digital band data output from the **BANDDATA** jack on the rear panel of the transceiver. Most other amplifiers can be adapted to operate with the **MARK-V FT-1000MP Field**; however, the main points to be concerned with are the switching requirements of the amplifier, and if QSK (full break-in) operation is desired. The linear amplifier Tx/Rx switching capability of the **MARK-V FT-1000MP Field** is described in the table below.

Parameter	Operation	
	QSK Relay Disabled	Non-QSK Relay Enabled
DC Switching Voltage	< 40VDC	< 60 VDC
DC Switching Current	< 150 mA	< 200 mA
AC Switching Voltage	—	< 100 VAC
AC Switching Current	—	< 500 mA

OPERATION WITH QSK AMPLIFIERS

Connect the RF output from the transceiver **ANT** jack (**A** or **B**) to the RF input jack of the linear. Connect the ALC output from the linear to the **EXT ALC** jack on the rear of the transceiver (see the “About ALC” discussion below). After making the RF and Tx/Rx switching connections described below, you may need to adjust the ALC output level of the linear so that it is not overdriven by the **MARK-V FT-1000MP Field**. Your linear’s manual should describe how to do this.

If using a **VL-1000**, connect the **BAND DATA** Cable (supplied with the **VL-1000**) from the transceiver **BAND DATA** jack to the amplifier **BAND-DATA 1** jack; this will provide automatic band selection for the linear, as well as QSK Tx/Rx switching control. You may also connect a user-constructed control cable (refer to **VL-1000** manual for details) from the transceiver **REMOTE** jack to the amplifier **BAND-DATA 2** jack to provide automatic amplifier tune-up for the linear using the **MARK-V FT-1000MP Field**. Press the **VL-1000**’s front panel **ATT** switch to **disable** the 3 dB input RF power attenuator.

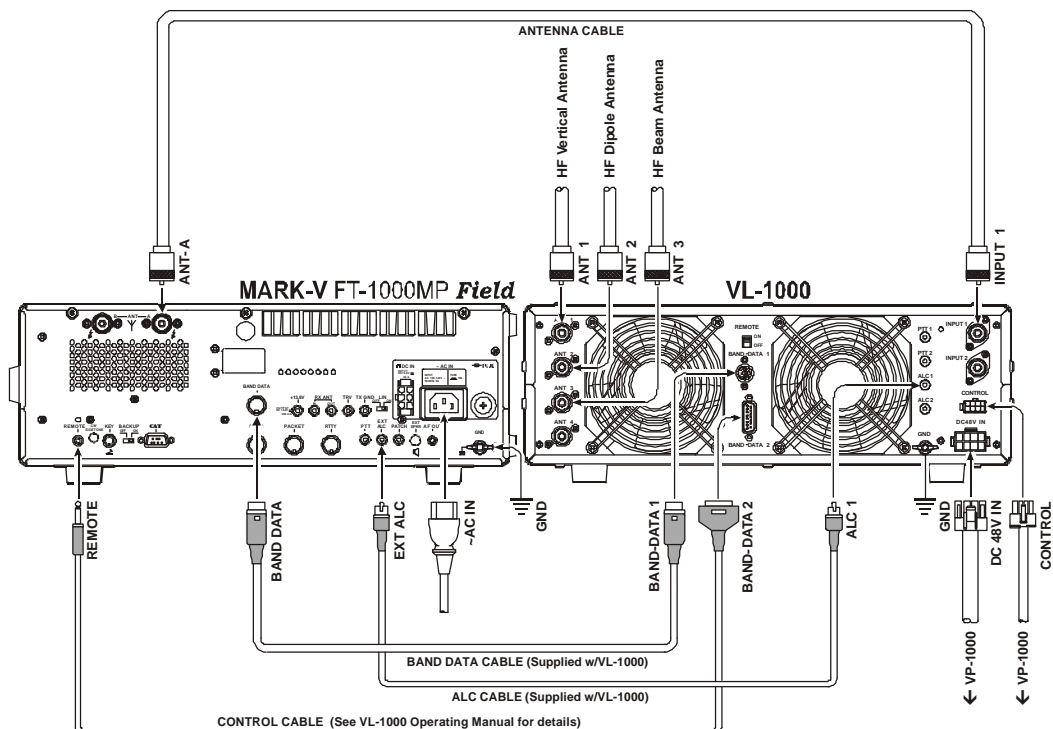

ACCESSORY INSTALLATION

LINEAR AMPLIFIER INTERFACING

If using an **FL-7000**, connect optional cable **E-767** (P/N D4000019) from the transceiver **BAND DATA** jack to the amplifier **ACC-2** jack. This provides automatic band selection for the linear, as well as QSK Tx/Rx switching control. Turn on the **FL-7000** rear panel **ATT** switch to **disable** the 3 dB input RF power attenuator.

If using another manufacturer's QSK linear, and if its switching circuitry consumes less than 150 mA of DC voltage below 40 V, you can connect the Tx/Rx switching line for the linear to pin 2 ("TX GND") of the **BAND DATA** jack (use pin 3 for ground), and the linear's exciter-enable output to pin 8 ("TX INHIBIT") of the **BAND DATA** jack. This line must be switched to ground to *enable* transmission once the linear is ready for excitation from the **MARK-V FT-1000MP Field**. If your QSK linear sinks more than 100 mA or uses more than 15 V for T/R relay switching, you will have to provide a suitable external interface transistor, controlled by pin 2. Be certain to make provision for suitable reduction of the drive power from the **MARK-V FT-1000MP Field**, so as not to damage your amplifier.

OPERATION WITH NON-QSK AMPLIFIERS (FL-2100 SERIES OR OTHERS)

The **TX GND** jack on the transceiver rear panel is connected to an internal relay, for non-QSK T/R switching of linear amplifiers that use AC switching voltage, or DC voltage greater than +15 V, negative DC voltage of any kind (such as the Heath® SB-220/SB-221 models), or if they are required to sink more than 100 mA for T/R switching. A schematic diagram of the relay circuit is provided below. If not using your linear amplifier in a full break-in environment, the use of this relay for amplifier switching is highly recommended.

This relay comes disabled (rear-panel **LIN** set to "OFF") to avoid the clicking sound when the transceiver is used alone or with a QSK linear. To enable the relay for non-QSK linears that exceed the above T/R switching requirements, you will need to move the **LIN** switch, located in the hole near the center of the rear panel, to its right position (see the drawing). Use a thin, insulated, sharp object to move the switch. Then connect the center contact of the **TX GND** jack to the positive relay-control line to your linear, and the outer contact to the "common" line or the linear's chassis ground. Refer to the diagram at the next page; in this example, a older non-QSK amplifier (**FL-2100B**) is shown.

With the relay now enabled, the **MARK-V FT-1000MP Field** can support non-QSK linear T/R switching voltages up to 100 VAC @ 500 mA, or DC voltage up to 60 V @ 200 mA, or closed-circuit current up to 1 A with DC voltage up to 30 V.

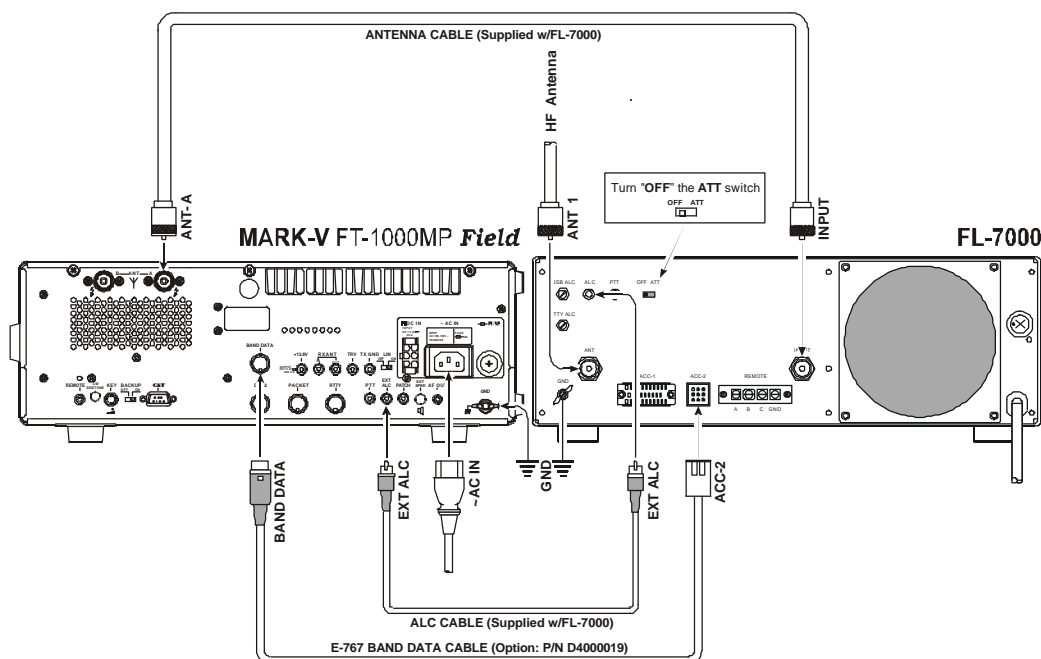

LINEAR AMPLIFIER INTERFACING

Caution - Please Read!!

The **MARK-V FT-1000MP Field** is designed for use with the **FL-7000/VL-1000** when QSK operation with a linear amplifier is desired. If you are using a different amplifier, do not attempt QSK operation with the linear if its switching circuitry requires that the **MARK-V FT-1000MP Field's** relay be enabled. Using pins 2 and 8 of the **BAND DATA** jack for other amplifiers will not work unless the control line signals are carefully matched, and damage may result otherwise.

Your transceiver's warranty does not cover damage resulting from improper connections to this jack, so if you are not sure of the linear amplifier's break-in capabilities or switching requirements, the safest approach is to enable the relay, use the **TX GND** jack (after setting the **LIN** switch to the "ON" position) and resort to non-QSK operation. This will help prevent possible damage to the amplifier or transceiver.

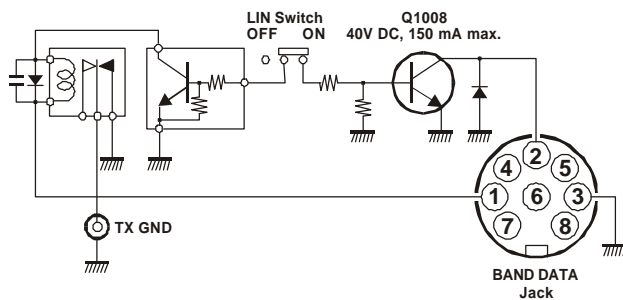

ABOUT ALC

The **MARK-V FT-1000MP Field** provides an external **ALC** jack on the rear panel (RCA-type jack) for input of **A**utomatic **L**evel **C**ontrol voltage from a linear amplifier.

ALC voltage is used to provide dynamic control of the output of the transceiver, so as not to provide more drive than is needed for full amplifier output. The ALC control voltage range is 0 to -4 V DC, with the voltage going more negative as the amplifier's drive requirements are approaching fulfillment.

The **MARK-V FT-1000MP Field's** ALC system is very typical of designs in the amateur radio industry, and consequently is compatible with many manufactured and home-built amplifiers. However, ALC voltage may be generated by an amplifier in a manner incompatible with efficient ALC operation in the **MARK-V FT-1000MP Field**, and it is important that you recognize the differences in amplifier ALC circuits before proceeding with ALC line connection.

❑ ALC circuits which detect **Power Output** from the amplifier, and generate negative-going ALC control voltage when maximum output power has been realized, will generally work properly with the **MARK-V FT-1000MP Field**.

The exact amount of ALC voltage fed to the **MARK-V FT-1000MP Field** can usually be adjusted via a potentiometer on the rear panel of the amplifier.

❑ ALC circuits which detect **Amplifier Tube Grid Current**, and generate ALC voltage when excessive grid current is present, may not work well with the **MARK-V FT-1000MP Field** and other similar transceivers, as the ALC voltage may be generated because of amplifier mis-tuning not related to an excessive-drive condition. With amplifiers deriving their ALC voltage in this manner, we recommend that you *not* connect the ALC line, and rather let the amplifier's protection circuitry manage its ALC requirements internally.

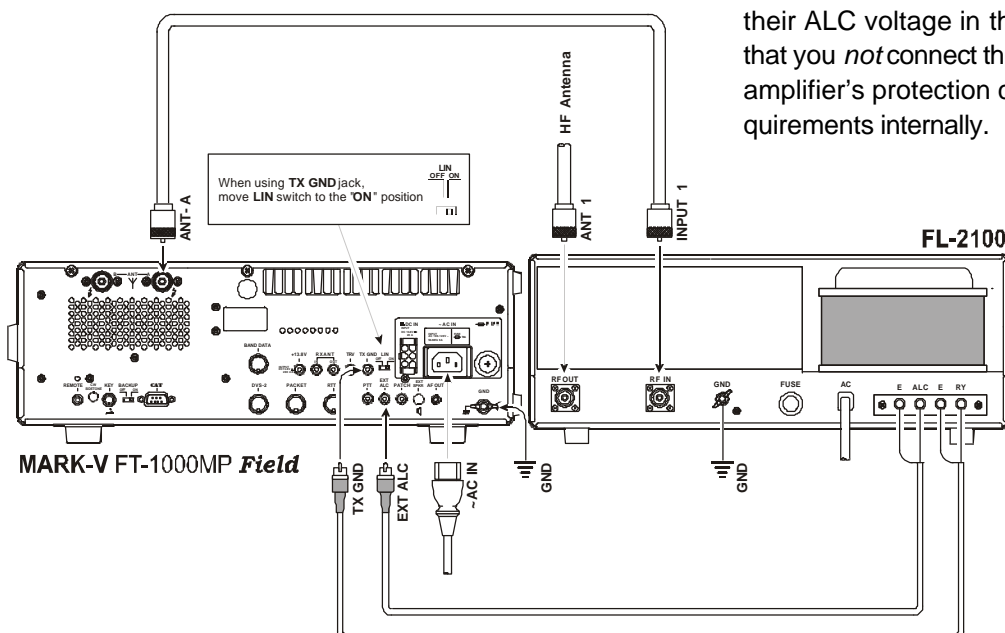

ACCESSORY INSTALLATION

TRANSVERTER OPERATION

The **MARK-V FT-1000MP Field** can be used with the optional Yaesu **FTV-1000** 50 MHz Transverter, providing excellent receiver performance and up to 200 Watts of power output.

Besides the **FTV-1000**, you must purchase the **FP-29** AC Power Supply and install the **FRB-5** Relay Unit into your **MARK-V FT-1000MP Field**.

A typical **FTV-1000** setup is shown below. Installation information for the **FRB-5** is provided in the **FRB-5** Installation Manual, while connection and operation instructions for the **FTV-1000** may be found in that model's Operating Manual.

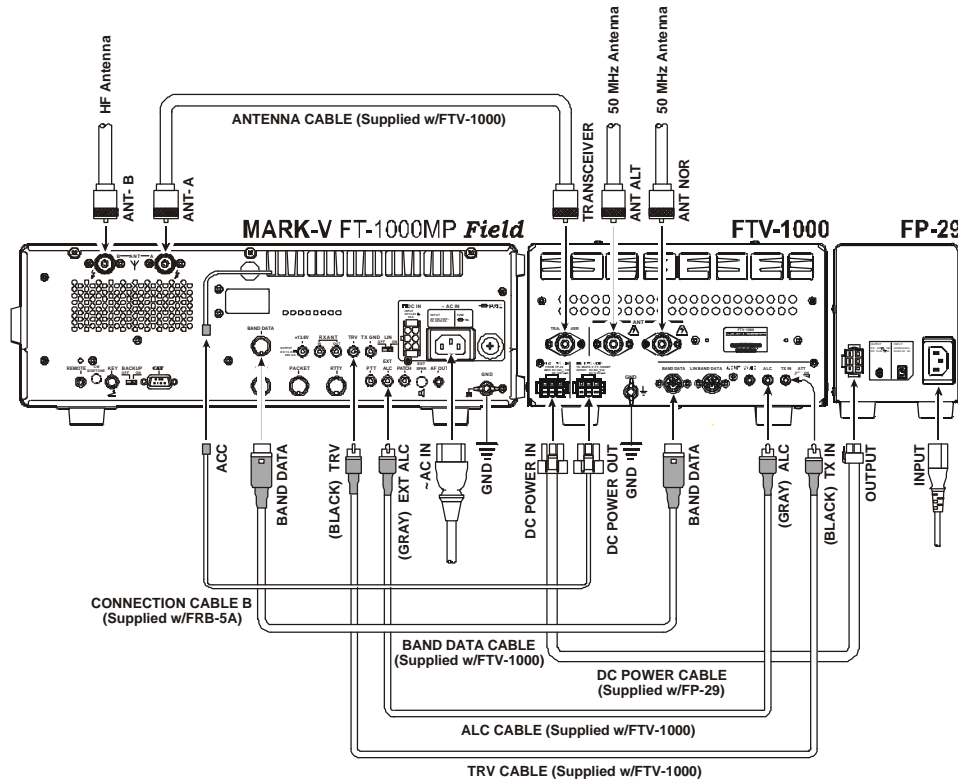

DIGITAL MODEM (TNC, WEATHERFAX, ETC.) INTERFACING

The **MARK-V FT-1000MP Field** offers special features for digital modes, such as a built-in digitally-synthesized AFSK generator for RTTY and AMTOR terminal units, IF bandwidth optimization and automatic display offsets, and an 18-ms transmit-to-receive turnaround time.

Low-level Main Receiver audio output is provided from the rear-panel **RTTY** and **PKT** jacks, and is unaffected by front panel volume control settings. If you prefer to use Sub Receiver audio for TNC input, switch **S3001** (located on the AF UNIT circuit board, inside the transceiver, between the **DVS-2** and **PKT** connectors) can be moved from the MAIN to the SUB position.

Audio level is 100 mV from both jacks. The RTTY level is fixed; however, PKT audio level can be adjusted by potentiometer **VR3010**. In many cases, it is easier to perform level adjustments at the TNC.

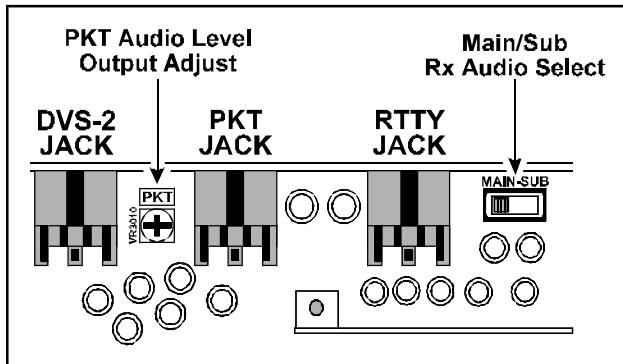

DIGITAL MODES WITH A TNC OR COMPUTER SOUND CARD (PSK-31)

The explosion of new digital modes of amateur communication means that you will want to make connections to your TNC and/or computer as “standardized” as possible. Generally, this will mean that you will want to connect your transceiver in an “AFSK” environment. On the **MARK-V FT-1000MP Field**, the **PACKET** jack is the “AFSK” connection port, while the **RTTY** jack is an “FSK” connection port. In the AFSK mode, the TNC or computer generates the data signal as a set of audio tones, while the FSK mode uses a *closure to ground* (in the TNC or terminal unit) to cause the transceiver to generate the “mark” and “space” tones.

PACKET TONE INFORMATION	
TNC Tone Pair	Tone Center Frequency
1070/1270 Hz	1170 Hz
1600/1800 Hz	1700 Hz
2025/2225 Hz*	2125 Hz*
2110/2310 Hz	2210 Hz

* indicates default setting (used by normal convention)

ACCESSORY INSTALLATION

DIGITAL MODEM (TNC, WEATHERFAX, ETC.) INTERFACING

Construct a patch cable or cables to make the necessary connections between your TNC and the appropriate rear panel jack(s) (**RTTY** for FSK, **PACKET** for AFSK). Refer to the pin-out diagram below, and the wiring instructions included with your TNC. A description of the **PACKET** jack's individual pins follows:

Pin 1 (DATA IN) - Connect this pin to your TNC's "AFSK Out" or "Mic Audio" output line. The optimum input level is 30 mV rms, and the input impedance is 3 k Ω . Your TNC's audio output level potentiometer will allow you to set the level to the optimum value. This pin may be used either for 300 baud SSB-mode digital operation or for 1200-baud FM packet. The bandwidth and frequency response are not, however, suitable for 9600 baud operation.

Pin 2 (Ground) - Connect this to the shield(s) of the cable(s) used for connections between the TNC and the **MARK-V FT-1000MP Field**.

Pin 3 (PTT) - Connect this pin to the PTT line from the TNC. This pin, when grounded by the TNC, places the **MARK-V FT-1000MP Field** into the Transmit condition.

Pin 4 (DATA Out) - Connect this pin to your TNC's "RX Audio" input line. This is a constant-level (100 mV rms @ 600 Ω) audio output line which is *not* affected by the position of the front-panel **AF GAIN** control.

Pin 5 (BUSY) - This is a "Squelch Status" pin not generally required for digital mode operation. This pin is held at +5V when the squelch is open, and is grounded when the receiver is muted by the squelch ("no-signal" condition).

For FSK operation using the **RTTY** jack, the following are the pin connections required:

Pin 1 (SHIFT) - Connect this pin to your TNC or terminal unit's "FSK Key" port. Closing and opening of this line to ground causes mark/space keying.

Pin 2 (RX AF OUT) - Same as "DATA OUT" on **PACKET** jack.

Pin 3 (PTT) - Same as "PTT" on **PACKET** jack.

Pin 4 (GND) - Same as "GND" on **PACKET** jack.

For operation on **PSK31**, connect your computer's sound card to the **PACKET** jack (for "PKT" mode operation) or the **MIC** and **EXT SP** jacks (for "SSB" mode operation). Also, use *menu selection 8-6* to configure the "User" mode (see page 110) for PSK31 operation.

For most operation, you will want to use the **PS31-U** (for PKT mode) or **PS31-SU** (for USB mode) options under "East Set;" while **BPSK** operation is not sideband-sensitive, **QPSK** operation, by convention, utilizes USB-side injection.

The "User" mode is accessed, during operation, by pressing and holding in for 1/2 second the **[PKT]** mode switch.

MARK-V FT-1000MP *Field*

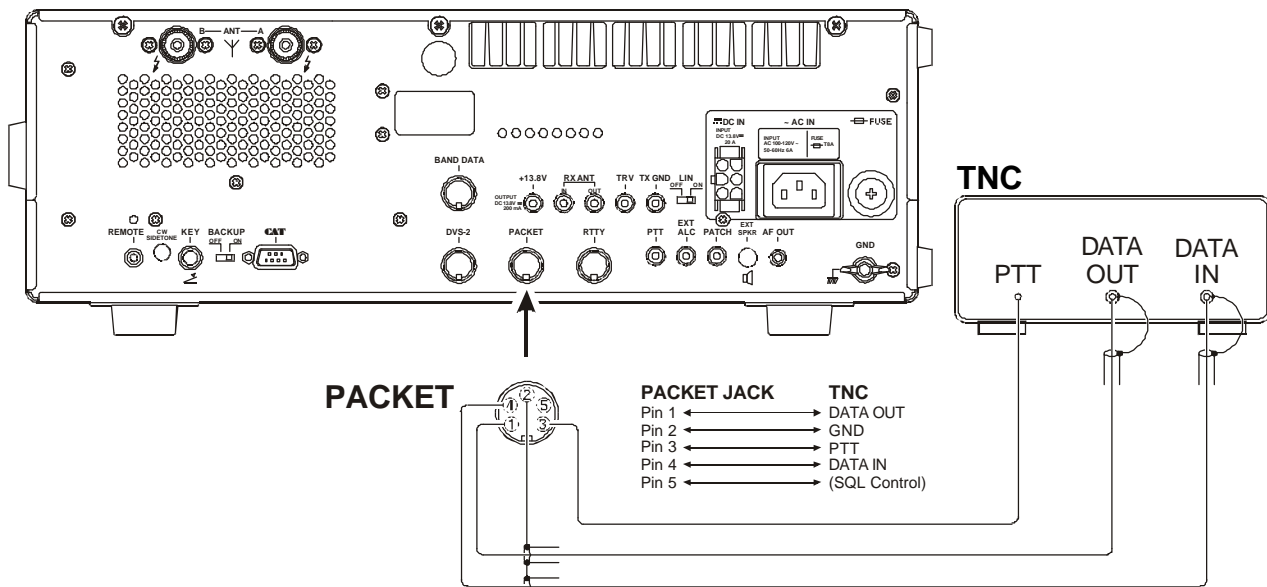

DIGITAL MODEM (TNC, WEATHERFAX, ETC.) INTERFACING

CAUTION!!

The **MARK-V FT-1000MP Field** cooling system is designed to handle continuous duty transmission at 100 watts output. However, for continuous-duty digital modes like RTTY, we recommend limiting your transmissions to 3 minutes or less, with at least 3 minutes receive in between transmissions. Place your hand on the transceiver occasionally to ensure that it's not getting too hot, and try to keep power output at 50 watts or less.

You can limit the maximum RF power output to 25 watts via programming, by recalling *menu selection 4-0* and choosing reduced power output.

MARK-V FT-1000MP *Field*

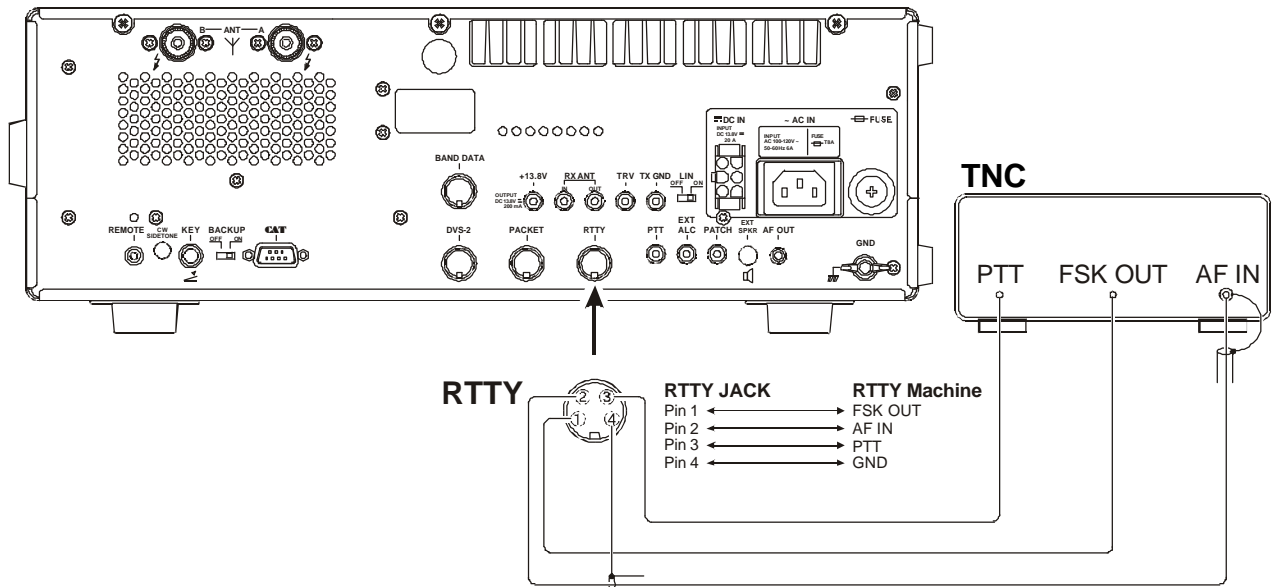

ACCESSORY INSTALLATION

DIGITAL MODEM (TNC, WEATHERFAX, ETC.) INTERFACING

NOTE: COMPUTER-GENERATED RFI

When using a TNC connected to your transceiver, or even having a PC located in the shack, the possibility exists that you may experience computer-generated RFI (Radio Frequency Interference).

The CPU in a personal computer operates with a crystal-controlled oscillator (clock), which may generate harmonics or other spurious signals. In addition, high-speed digital data switching uses square waves, which produce odd-order harmonic frequencies.

Computer-generated RFI may appear at seemingly random frequencies (usually right where a rare DX station is calling CQ!) throughout the range of your transceiver, and may sound like constant ticking or buzzing that may change as you type or work within a program. Severe RFI may have S-meter indications as much greater than S-9, making copy of voice signals difficult and data signals virtually impossible.

Computer-generated RFI is usually a result of inadequate shielding of the PC's cabinet or I/O and peripheral connections. While computer equipment may comply with RF emission approval standards, this does not ensure that sensitive amateur radio receivers will not experience RFI from the device.

There are a few steps you can take to reduce or eliminate computer-generated RFI. The first step is to ensure that only shielded cables are used for TNC-to-transceiver connections, carefully check RF ground connections and re-orient your station equipment in relation to the computer. Try moving your PC and peripherals slightly and see if it has any affect on the RFI, in some cases, this alone may be enough to correct the problem.

If not, several additional steps to try include installing AC line filters on the power cord(s) of the suspected equipment and inserting decoupling ferrite toroidal chokes on interconnecting patch/data cables and smaller ferrite beads on single wires.

As a last resort, you can try installing additional shielding within the PC case, using appropriate conductive mesh/screening or conductive tape. Especially check RF "holes" where plastic is used for cabinet front panels. For further information, consult amateur radio reference guides and publications relating to RFI suppression techniques.

OTHER DIGITAL/RECORDING DEVICE INTERFACING

AF OUT JACK

This is a 3.5 mm miniature stereo phone jack which provides constant-level (100 mV @ 600 Ω) for connection to a WeatherFax decoder, tape recorder, or other accessory. The audio output level is not affected by the setting of the front panel **AF GAIN & SUB AF** controls, so you can turn the volume down, if you like, without affecting the audio level being presented to your decoding device. The tip connection of this jack is Main receiver audio, while the ring connection is Sub receiver audio.

The connections to the **AF OUT** jack are at the same level as the connection to Pin 4 of the **PACKET** jack. However, the two output ports use independent output buffer amplifiers, so you can freely connect and disconnect devices to/from these ports without concern over the impedances and levels.

PTT (Push To Talk) JACK

This RCA jack is wired in parallel with the front panel's **MIC** jack, providing a handy connection point for a footswitch for voice operation, allowing hands-free PTT operation.

PATCH JACK

For transmit audio input for SSTV (Slow-Scan Television) operation, you may connect the SSTV terminal's Tx AUDIO line to the **PATCH** jack. You will need to disconnect the microphone, however, during transmission, as the **PATCH** jack is connected in a "Y" configuration along with the microphone input (from pin 8 of the **MIC** jack).

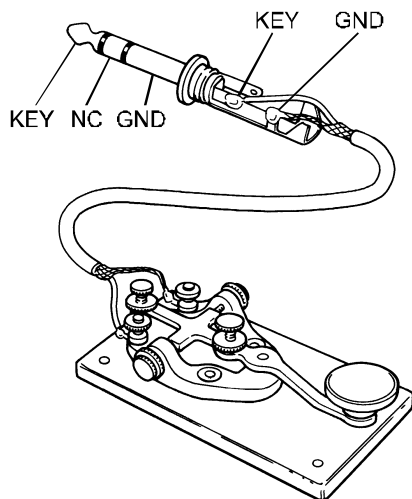

CW KEY/PADDLE AND COMPUTER KEYING INTERFACE SUGGESTIONS

FEATURES

The **MARK-V FT-1000MP Field** includes a host of features for the CW operator, the functions of which will be detailed in the "Operation" section later. Besides the built-in Electronic Keyer, two key jacks are provided, one each on the front and rear panels, for convenient connection to keying devices.

Both **KEY** jacks on the **MARK-V FT-1000MP Field** utilize "positive" keying voltage. Key-up voltage is approximately +5V DC, and key-down current is approximately 0.5 mA. When connecting a key or other device to the **KEY** jacks, use *only* a 3-pin ("stereo") ¼" phone plug; a 2-pin plug will place a short between the ring and (grounded) shaft of the plug, resulting in a constant "key-down" condition in some circumstances.

CONFIGURATION SUGGESTIONS

1. For everyday operation using the internal electronic memory keyer, connect your paddle to the *front panel KEY* jack, and activate the front panel [**KEY**] switch. If you wish to keep the keyer paddle's cable out of the way, connect the plug, instead, to the rear panel **KEY** jack.
2. If two operators are using the **MARK-V FT-1000MP Field** simultaneously (for a contest, Field Day, etc.), a second keyer paddle may be connected to the *rear panel KEY* jack. With the front panel [**KEYER**] switch pressed in, both operators' paddles will have access to the internal keyer.
3. If two operators are using the **MARK-V FT-1000MP Field** simultaneously, but both wish to use a straight key, outboard electronic keyer, or computer-driven keying cables, the key plugs may be inserted into the front and rear panel **KEY** jacks; now turn the front panel's [**KEYER**] switch off.

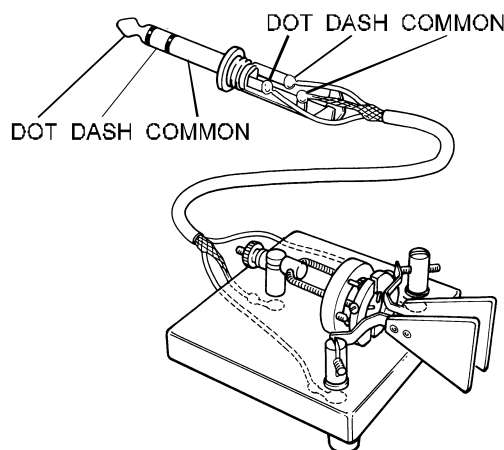

ACCESSORY INSTALLATION

ANTENNA CONNECTIONS

The **MARK-V FT-1000MP Field**'s three antenna connectors, plus innovative microprocessor-based memory and switching circuits, provide excellent flexibility in setting up your antenna connections.

Typical antenna configurations are shown below. Remember that Antenna **A** and Antenna **B** (which are "SO-239" or "M" connectors) may be used for transmission and reception, while the RX Antenna port (which is an "RCA" type connector) may only be used for reception.

NOTE REGARDING LARGE RECEIVE ANTENNAS

Although surge suppression is provided on all antenna ports, you may wish to consider building a simple external circuit which will disconnect, on TX, any antenna connected to the **RX ANT IN** jack, particularly if you are using a very long wire antenna such as a Beverage. Very long antennas can build up very high RF and static voltages on them, and the circuit below may provide better protection for your receiver's input circuitry.

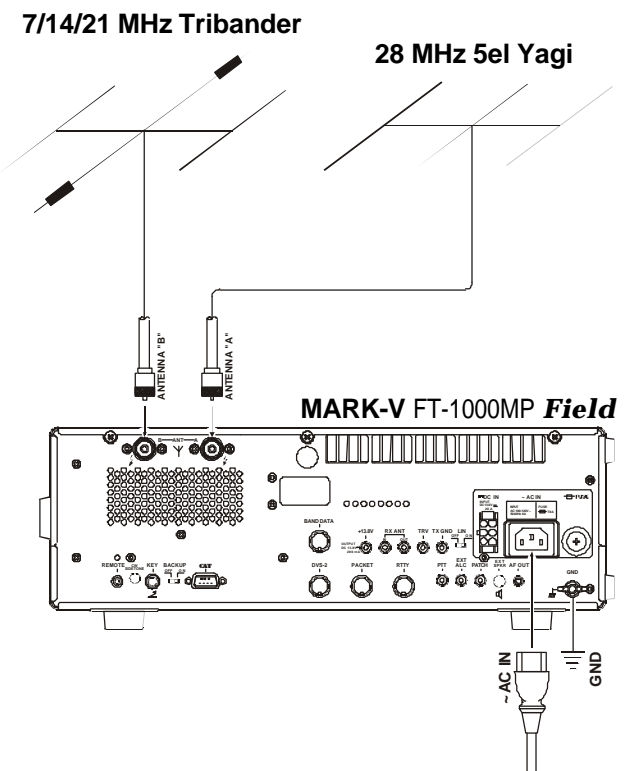
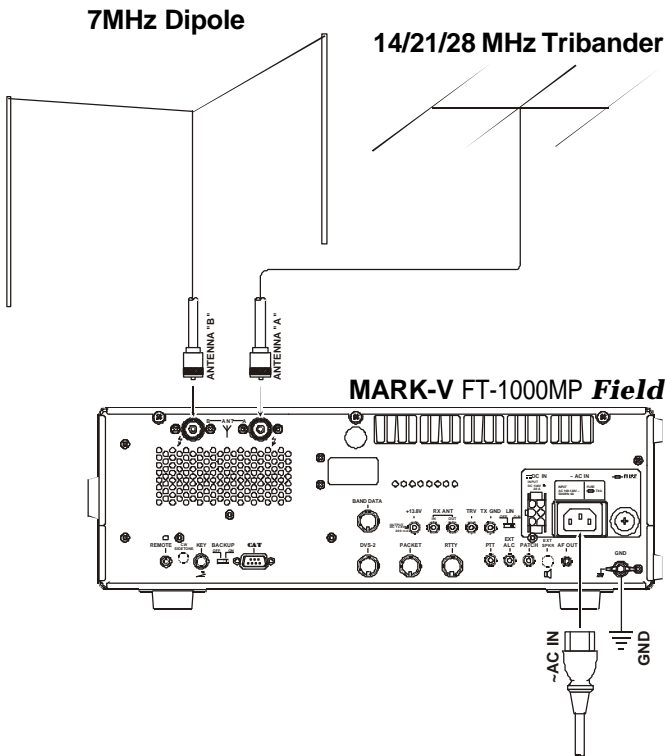

PERSONAL COMPUTER INTERFACING FOR CONTEST SOFTWARE, ETC.

The **MARK-V FT-1000MP Field** features a built-in level converter, allowing direct connection from the rear-panel **CAT** jack to the serial port of your computer, without the need for any external converter box.

When your software requests serial port configuration information, set it for "4800,N,8,2" (4800 baud, No Parity, 8 Data Bits, and 2 Stop Bits). Be certain to configure and activate any required "TSR" (Terminate-and-Stay-Resident) utilities before beginning computer-controlled transceiver operation (your software's instruction manual will describe any such requirement).

Details regarding the programming protocols for the **CAT** system may be found beginning on page 86.

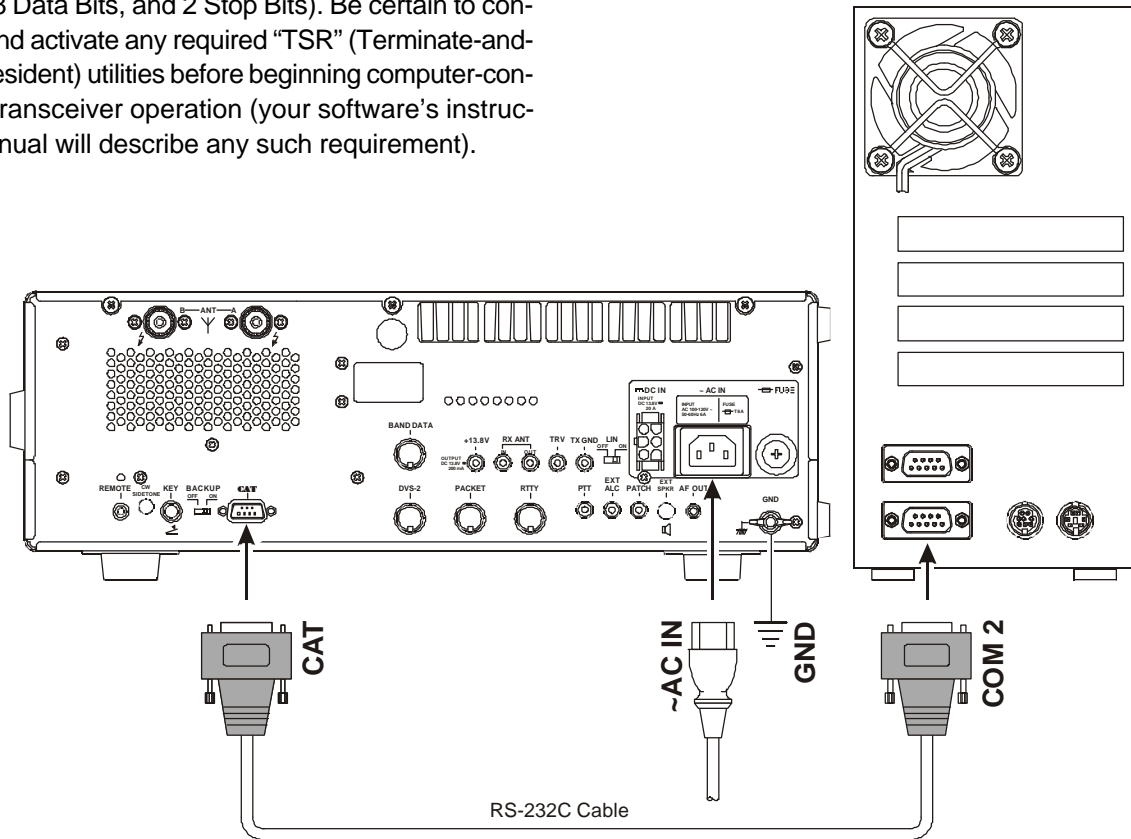

FRONT PANEL CONTROLS

This chapter describes each control and connector on the **MARK-V FT-100MP Field**. You can just glance through it quickly now, but some of the descriptions will be more meaningful if you take the time to read them in detail now. If questions arise later while proceeding through the operation chapter, you can return to this chapter with the set powered up for control knob clarification. Some controls and switches are disabled under certain conditions.

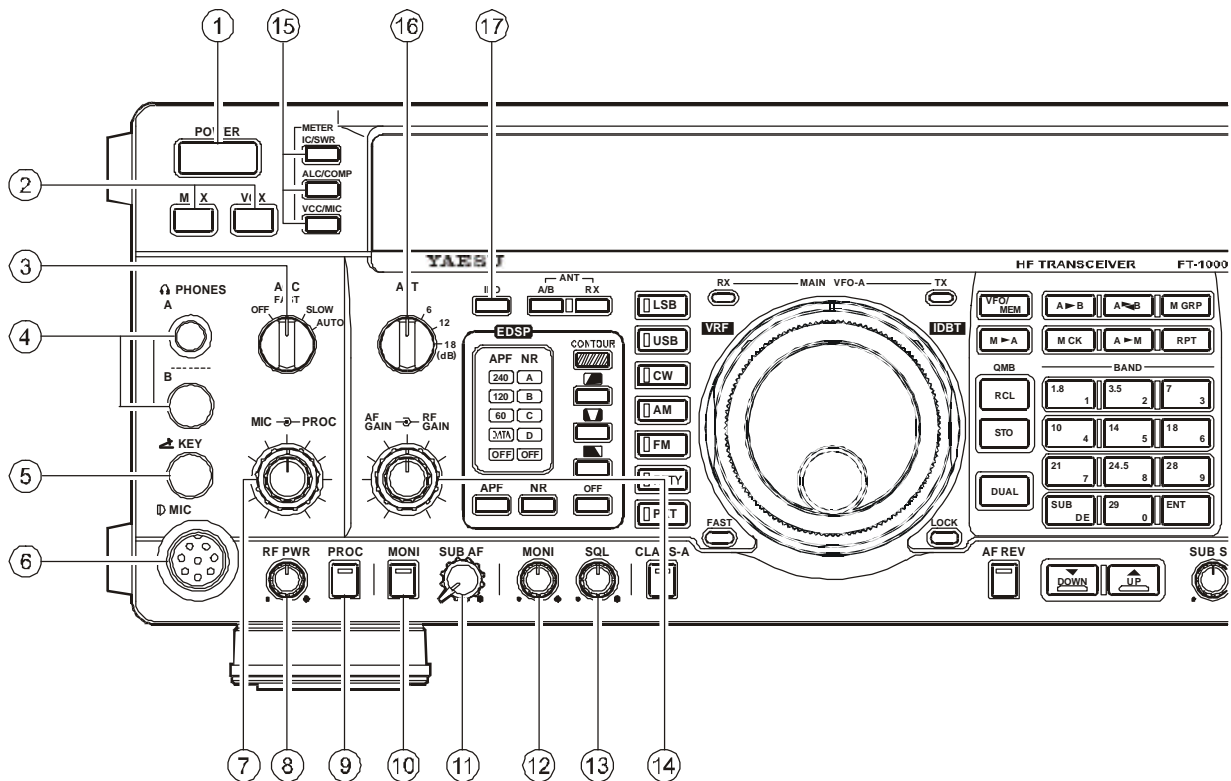

① POWER Button

This button turns the transceiver on and off.

② MOX & VOX Buttons

[**MOX**] may be used in place of a microphone **PTT** switch or footswitch to activate the transmitter, when depressed. It must be in the undepressed position for reception.

[**VOX**] enables automatic voice-actuated transmitter switching in the SSB, AM and FM modes, and “semi-break-in” keying in CW mode. The controls affecting VOX operation are located in the top access panel. *Menu Selection 7-5* sets the receiver recovery time during semi-break-in CW operation.

③ AGC Selector Knob

Selects main receiver Automatic Gain Control decay time for most comfortable reception, or disables receiver AGC (off). Normally this switch is set to the “**AUTO**” position. Strong signals will cause distortion if this selector is set to “**OFF**.”

④ PHONES Jack

A ¼-inch and 3.5 mm, 3-contact jack accept either monaural or stereo headphones with 2- or 3-contact plugs. When a plug is inserted, the loudspeaker is disabled. With stereo headphones such as the optional **YH-77STA**, you can monitor both receiver channels at the same time during dual reception. In this case, the headphone HP controls (page 32) beneath the top access panel adjust the default levels for mixed, separate, or monaural headphone operation.

⑤ KEY Jack

This ¼-inch, 3-contact jack accepts a CW key or keyer paddles (for the built-in electronic keyer), or output from an external electronic keyer. *You cannot use a 2-contact plug in this jack* (to do so produces a constant “key down” condition). Pinout is shown on page 4. Key up voltage is 5 V, and key down current is 0.5 mA. There is another jack with the same name, connected in parallel with this jack, on the rear panel.

⑥ MIC Jack

This 8-pin jack accepts input from the **MH-31B8D** Microphone. **MIC** connector pinout is shown on page 4. Proper microphone input impedance is 500 ~ 600 Ohms.

⑦ MIC → PROC Knob

The inner **MIC** control adjusts the microphone input level for (non-processed) SSB and AM transmission.

The outer **PROC** control sets the compression (input) level of the transmitter RF speech processor in the SSB modes, when activated by the button with the same name.

⑧ RF PWR Knob

This control adjusts the transmitter's output power in all modes. The adjustment range is from approximately 5 to 100 watts, except in the AM mode, where the permitted carrier level is about 5 to 25 watts. This knob also controls the carrier level for CW transmission. In setting the output power, the ALC function of the meter should always be monitored, to avoid overdriving the transmitter final amplifier.

In the "**Class A**" SSB operating mode, the adjustment range for power output will be between approximately 5 and 25 watts.

⑨ PROC Button

This button enables the RF speech processor for SSB transmission. Processing level is set by the outer control with the same name. While activated, the LED in this button glows red.

⑩ MONI Button

This orange button enables the transmit (RF) monitor in all modes (except CW, in which the monitor function is always on, to produce the sidetone). While activated, the LED in this button glows red.

⑪ SUB AF Knob

The **SUB AF** control adjusts the audio volume of the sub receiver VFO in the speaker or headphones.

The **AF GAIN** control, located above, and this **SUB AF** control can be rotated to adjust the relative balance of receiver audio between the two receiver channels during dual reception.

Menu selection 2-8 (AF GAIN) allows the **SUB AF** control to be changed into a "Balance" control for the two audio channels, if desired. In this case, the **AF GAIN** control (see next column) will adjust the volume level for both the Main and Sub receivers, while the **SUB AF** control will control the balance. See page 101 for details.

⑫ MONI Knob

When activated by the **[MONI]** button (above), the audio level of the transmit RF monitor during transmission (relative to the **AF GAIN** control) is adjusted by this control.

⑬ SQL Knob

This control sets the signal level threshold at which main VFO-A receiver audio is muted (and the green "**MAIN BUSY**" display indicator turns off), in all modes. This control is normally kept fully counter-clockwise, except when scanning and during FM operation.

⑭ AF GAIN → RF GAIN Knob

The inner **AF GAIN** control adjusts the audio volume of the main receiver VFO in the speaker or headphones.

The outer **RF GAIN** control adjusts the receiver signal level in front of the main receiver 1st mixer (via PIN diodes), and also the gain of the main receiver IF amplifiers.

It is normally set fully clockwise for maximum sensitivity. When rotated counter-clockwise, the S-meter minimum deflection point will move up the scale. The peak deflection for a particular signal will remain the same if it is greater than the level set by this control, but the main receiver will be less sensitive to weaker signals.

This control also affects the SQL setting for main VFO-A, and should be preset fully clockwise when setting the squelch threshold for the VFO or on a recalled memory.

⑮ METER Selector Switches

These switches determine the function of the multifunction meter during transmission. The meanings of the abbreviations are as follows:

- IC/SWR** - Final amplifier collector current (Amps) and Standing Wave Ratio (forward: reflected).
- ALC/COMP** - Relative Automatic Level Control voltage and RF speech compressor level (in dB, for SSB modes only).
- VCC/MIC** - Final amplifier collector voltage and microphone gain input level.

The meter indicates power output and the selected parameter during transmission, and signal strength in S-units during reception (on the main receiver). Each S-unit is approximately 6 dB.

⑯ ATT Selector Knob

This knob inserts 6, 12, or 18 dB (1, 2, or 3 S-units) of attenuation before the mixer to suppress band noise and reduce the possibility of overload from very strong signals.

⑰ IPO Button

The Intercept Point Optimization button may be used to set optimum receiver front end characteristics for a strong environment. Selecting **IPO** bypasses the front end RF amplifier and feeds the received signals directly to the first mixer.

FRONT PANEL CONTROLS

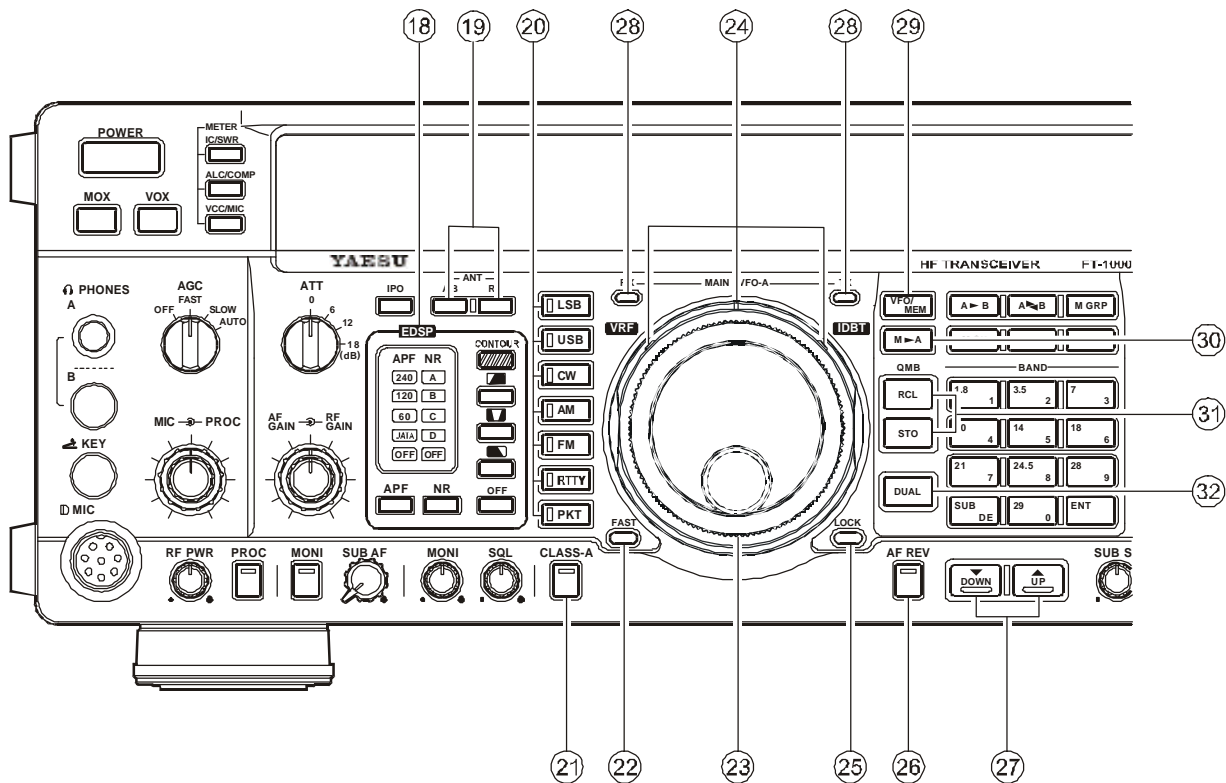

18 EDSP Filters

(A) APF

Selects and indicates the bandwidth for the EDSP CW audio peaking filter. Pressing the [APF] switch selects the bandwidth to be used for the EDSP CW audio peaking filter, with available selections of **240(Hz)/120(Hz)/60(Hz)/DATA** (DATA is an optimized bandwidth for FAX, PACKET or SSTV operation, user-optimized via the Menu), or "OFF," and the indicator changes according to the bandwidth selected. The most narrow setting is highly useful for very-weak-signal CW work.

(B) NR

Selects and indicates the setting of the EDSP Noise Reduction feature. Pressing the [NR] switch selects one of four EDSP noise reduction settings, and the indicator changes according to the selection chosen (choose the selection providing the most effective reduction of noise under current operating conditions).

(C) CONTOUR

Press one of these four switches to select the desired EDSP (CONTOUR) filter.

: Low Cut Filter (*High-frequency emphasis*)
Pressing this button activates the EDSP Low Cut Filter; the **CONTOUR** LED will glow **green**.

: Mid Cut Filter (*High- & Low-frequency emphasis*)
Pressing this button activates the EDSP Medium Cut Filter; the **CONTOUR** LED will glow **orange**.

: High Cut Filter (*Low-frequencies emphasis*)
Pressing this button activates the EDSP High Cut Filter; the **CONTOUR** LED will glow **red**.

OFF:

EDSP filter is off; the **CONTOUR** LED will **go out**.

19 ANT [A/B RX] Buttons

[A/B] - Pressing this selects either the **ANT A** or **B** jack on the rear panel, and allows convenient antenna switching at the press of a button. The selected antenna jack is also indicated at the top of the display (above the channel group number).

[RX] - Normally, the antenna connected to the **ANT A** or **B** jack is used for receive (and always used for transmitting). When this switch is pressed (display indicator on), an antenna connected to the **RX ANT IN** jack is used during receive.

20 MODE Selection Buttons

These momentary buttons select the operating mode, indicated by the LED in each button. Pressing AM, CW, RTTY, or PKT multiple times will switch between the alternate operating features that can be used by these modes (covered later). Also, when you press and hold in the [PKT] key for one second, the user-programmed custom function setting mode will be activated.

⑳ CLASS-A Button

This button changes the final amplifier operating mode to **Class-A**. When operating the final amplifier in the **Class-A** mode, the maximum output power will be reduced to approximately 25 watts, and the LED inside this button will glow red. Operating SSB in **Class-A** yields an ultra-clean signal waveform.

㉑ FAST Button

For fast tuning, press this button (the “**FAST**” icon will appear), then rotate the main or sub tuning knobs (or press the **UP**(▲) or **DOWN**(▼) button). The tuning rate will increase ten times.

㉒ MAIN VFO-A Tuning Knob

This large knob adjusts the operating frequency of Main VFO-A (or a recalled memory). Default tuning increments are 10 Hz (100 Hz in AM and FM modes). When the [**FAST**] button has been pressed, the increments are 10x these sizes. See the table on page 38 for a listing of all available steps.

㉓ Shuttle Jog and VRF & IDBT Buttons

The **Shuttle Jog** ring allows fine or rapid frequency excursions with just a slight turn of your hand. Rotating the ring slightly either to the left or the right tunes downward or upward a few steps. The tuning rate increases the farther the ring is rotated.

Pressing the [**VRF**] button on the left side of the **Shuttle Jog** activates the **VRF** (Variable **RF** Front-end Filter), which adds a narrow input preselector filter into the RF receiver circuit on the 160-20 meter Amateur bands. Its passband can be tuned by rotating the **VRF/MEM CH** knob, located on the upper right corner of the front panel, for maximum sensitivity and out-of-band interference rejection.

Pressing the [**IDBT**] button on the right side of the Shuttle Jog activates the **IDBT** (Interlocked Digital Bandwidth Tracking) System, which matches the EDSP (Bandwidth) filter characteristics to the settings of the **SHIFT** and **WIDTH** knobs. Thus, it is not necessary to re-adjust the EDSP settings if you change the (IF) **WIDTH** and/or **SHIFT** settings; the EDSP settings will automatically follow those of the higher-frequency IF passband.

㉔ LOCK Button

This button toggles locking of the main tuning knob to prevent accidental frequency changes. “**LOCK**” is displayed in a red box below and to the left of the main frequency display field when this command is active (the tuning knob can still be turned, but it does nothing). Press [**LOCK**] again to enable the tuning knob.

㉕ AF REV Button

Pressing this reverses the main/sub receiver audio adjusted using the **AF GAIN** knob and **SUB AF** knob. When activated, the LED inside this button glows red.

㉖ DOWN(▼) & UP(▲) Buttons

Pressing either of these buttons momentarily steps the operating frequency down or up 100 kHz, respectively. Pressing and holding the [**FAST**] button while pressing one of these buttons steps the frequency down or up 1 MHz. Continue holding either button for repeated stepping.

㉗ MAIN VFO-A [RX & TX Switch-LED]

These combination lamp-switches select and indicate the transmit/receive status of the main tuning knob and display. When the green “**RX**” lamp is lit, the *receiving* frequency is under control of the main knob and display (either VFO-A or a recalled memory channel). When the red “**TX**” lamp is lit, the *transmitting* frequency is under control of the main knob and display. Thus, for “normal” (non-split) operation, both the red and green lamps associated with the main tuning knob will be illuminated.

㉘ VFO/MEM Button

This button toggles main receiver operation between the memory channel and the main VFO-A. Either “**VFO**,” “**MEM**,” or “**M TUNE**” will be displayed to the left of the main frequency display field to indicate the current selection. If a displayed memory has been returned, pressing this button returns the display to the original memory contents, and pressing it again returns operation to the Main VFO.

㉙ [M ► A] Button

Pressing this button momentarily displays the contents of the currently-selected memory channel for three seconds. Holding this button for ½ second copies the data from the currently selected memory to the Main VFO-A, as two beeps sound. Previous data in the Main VFO will be overwritten.

㉚ QMB Buttons

[**RCL**] (Recall) - Recalls one of up to five Quick Memory Bank memories for operation.

[**STO**] (Store) - Pressing this copies operating parameters into consecutive QMB Memories.

㉛ [DUAL] Button

This button activates dual-channel reception with the main and sub receivers. When this function is active, “**DUAL**” will be displayed in a box at the left edge of the display.

FRONT PANEL CONTROLS

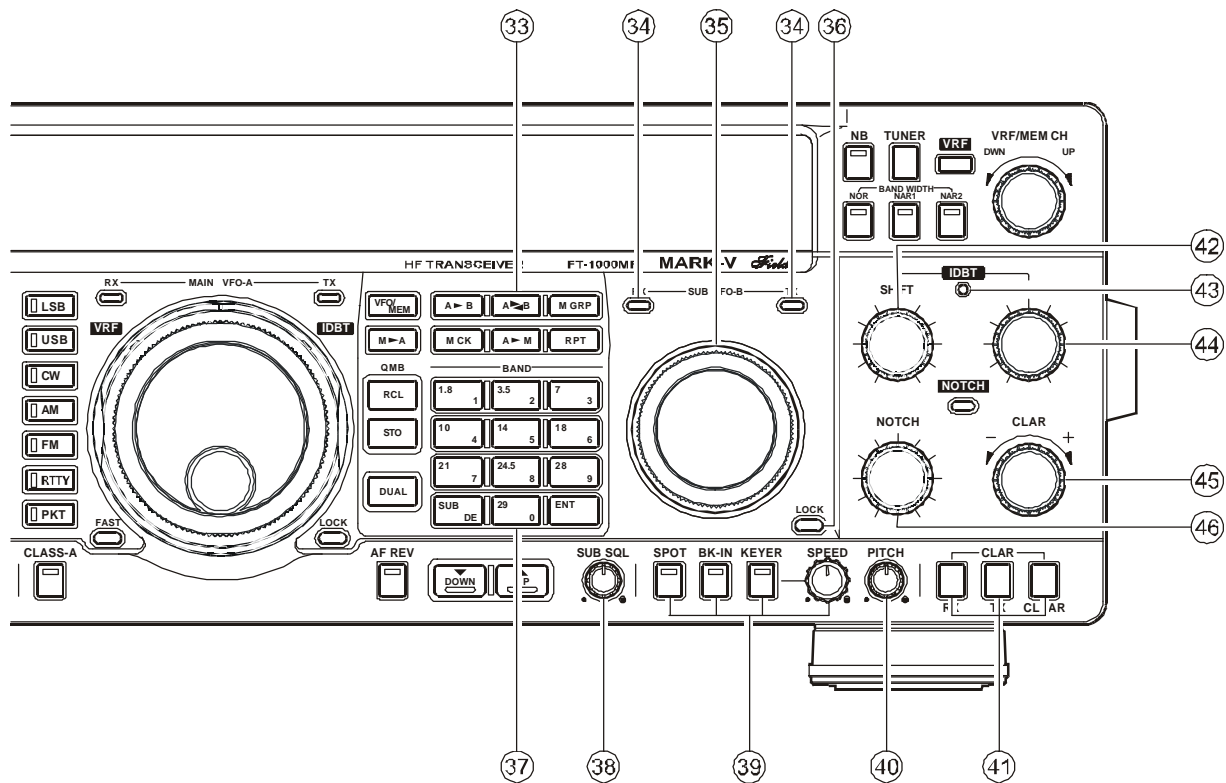

33 VFO & Memory Control

[A ▶ B] Button:

Pressing this button for ½ second (until the double beep) transfers data from the main display (either Main VFO-A or a recalled memory channel) to Sub VFO-B, overwriting any previous contents in the Sub VFO. Use this key to set both Main and Sub Receivers to the same frequency and mode.

[A ▶ B] Button:

Pressing this button *momentarily* exchanges the contents of Main VFO-A (or a recalled memory channel), and Sub VFO-B. No data is lost.

[M GRP] Button:

When more than one memory group has been enabled, pressing this button limits selection and scanning to those memories within the selected group.

[M CK] (Memory Check) Button:

This key displays the contents of memory channels without disturbing operation. When pressed, “M CK” is displayed above the channel number, and each memory channel can then be checked on the Sub Receiver display by rotating the **VRF/MEM CH** selector. Empty memory channels display as two decimals, with no frequency digits. Press this button again to cancel memory checking.

[A ▶ M] Button:

Pressing and holding in this key for ½ second (until the double beep) copies the current operating data from Main VFO-A, or a recalled memory, to the currently selected memory channel, overwriting any previous data stored there. Also, pressing and holding this button after recalling a memory, without first retuning, causes the memory channel to be “masked,” and repeating the process restores the masked memory.

[RPT] Button:

For 29 MHz FM operation, this button activates the standard HF FM repeater offset. Pressing [RPT] once or twice while receiving causes the transmit frequency to be shifted 100 kHz below or above the receiving frequency, respectively. A selectable CTCSS subaudible tone is also transmitted automatically when using this feature, to allow access to repeaters that require it. Pressing [RPT] a third time cancels repeater shift operation.

34 SUB VFO-B [RX & TX Switch-LED]

These lamps select and indicate the current status of Sub VFO-B. When the green “RX” lamp is lit, the *receiving* frequency is under control of SUB VFO-B. When the red “TX” lamp is lit, the transmitting frequency is under control of SUB VFO-B. During dual receive operation, the green “RX” lamps above both tuning knobs (Main and Sub) will be illuminated.

③⑤ SUB VFO-B Tuning Knob

This knob adjusts the Sub VFO-B operating frequency. The available tuning increments are the same as described for the main tuning knob, although each tuning knob's increments may be set independently (see page 38).

③⑥ [LOCK] Button

This button toggles locking of SUB VFO-B tuning to prevent accidental frequency changes. The red indicator in the display glows when this command is active (the tuning knob can still be turned, but it does nothing). Press the [LOCK] button again to re-enable the tuning knob.

③⑦ BAND (Keypad)

The keypad provides one-touch band selection, or direct frequency entry. Normally, pressing one of the ten white numbered keys selects the corresponding (MHz) amateur band for operation (pressing the SUB button first, followed by a [BAND] key, selects that band for the Sub VFO). If you press the white numbered key for the band you are already on, you will select the alternate subband VFO on that band. See the "Operation" chapter for details.

If the [ENT] key is pressed first, the yellow labels on the keys become effective, for manually entering any frequency one digit at a time; press [SUB(CE)] then [ENT] to enter Sub-VFO frequencies directly.

③⑧ SUB SQL Knob

This separate control sets the signal level threshold at which SUB VFO-B receiver audio is muted (and the green "SUB BUSY" display indicator turns off), in all modes. This control is normally kept fully CCW, except when scanning and during FM operation.

③⑨ CW and Electronic Keyer Controls

[SPOT] button turns the CW receiver spotting heterodyne oscillator on and off.

[BK-IN] button turns full break-in (QSK) CW operation on and off.

[KEYER] button toggles the internal CW keyer on/off, as indicated by the LED above this button.

[SPEED] knob adjusts the keying speed of the keyer.

④① PITCH Knob

Rotate this control to select your desired CW tone pitch (from 300~1050 Hz, in 50 Hz increments), as shown in the display. The Tx sidetone, receiver IF passband, and display offset from the BFO (carrier) frequency are all affected simultaneously.

④① [CLAR] Buttons

Pressing the [RX] button activates the CLAR knob, to allow offsetting the receiving frequency temporarily (see item ④⑤ below). The [TX] button provides the same function for the transmit frequency. If both buttons are pressed, the receiver and transmitter are both offset from the original frequency. Pressing the [CLEAR] button zeroes any offset tuned by the CLAR knob. Each memory and VFO retains all Clarifier settings independently.

④② SHIFT Knob

This knob offsets the center frequency of the IF passband when rotated from its "normal" (center) position. This control functions in all modes except FM.

When the IDBT System is activated by pressing the [IDBT] button on the Shuttle Jog, the EDSP (Bandpass) filter's passband offset changes according to this knob's setting.

④③ IDBT Indicator

This red indicator lights up when the IDBT System is activated by pressing the [IDBT] button on the Shuttle Jog. When this indicator is illuminated, the EDSP (Bandpass) filter's bandwidth and center frequency change according to the SHIFT and WIDTH knob settings.

④④ WIDTH Knob

This knob, when turned from center, reduces the overall IF bandwidth from either the lower or upper side, from the maximum selected by the [BANDWIDTH] buttons.

When the IDBT feature is activated by pressing the [IDBT] button on the Shuttle Jog, the EDSP (Bandpass) filter's passband width is reduced according to this knob's setting.

④⑤ CLAR Knob

This knob tunes the Clarifier offset frequency up to 9.99 kHz when activated by the CLAR [RX] [TX] buttons just below it (a 3-digit display appears in the center of the display (if enabled) when the Clarifier is active).

④⑥ NOTCH Knob

This knob adjusts the IF notch frequency when this feature is activated by the [NOTCH] button located above this knob. When activated, the LED inside the [NOTCH] button glows red.

Note that the setting of *menu selection 2-9* may disable the action of this knob (if *menu selection 2-9* is set to Auto DSP). With this selection, the EDSP Automatic Notch will be activated, and the IF Notch will be disabled.

FRONT PANEL CONTROLS

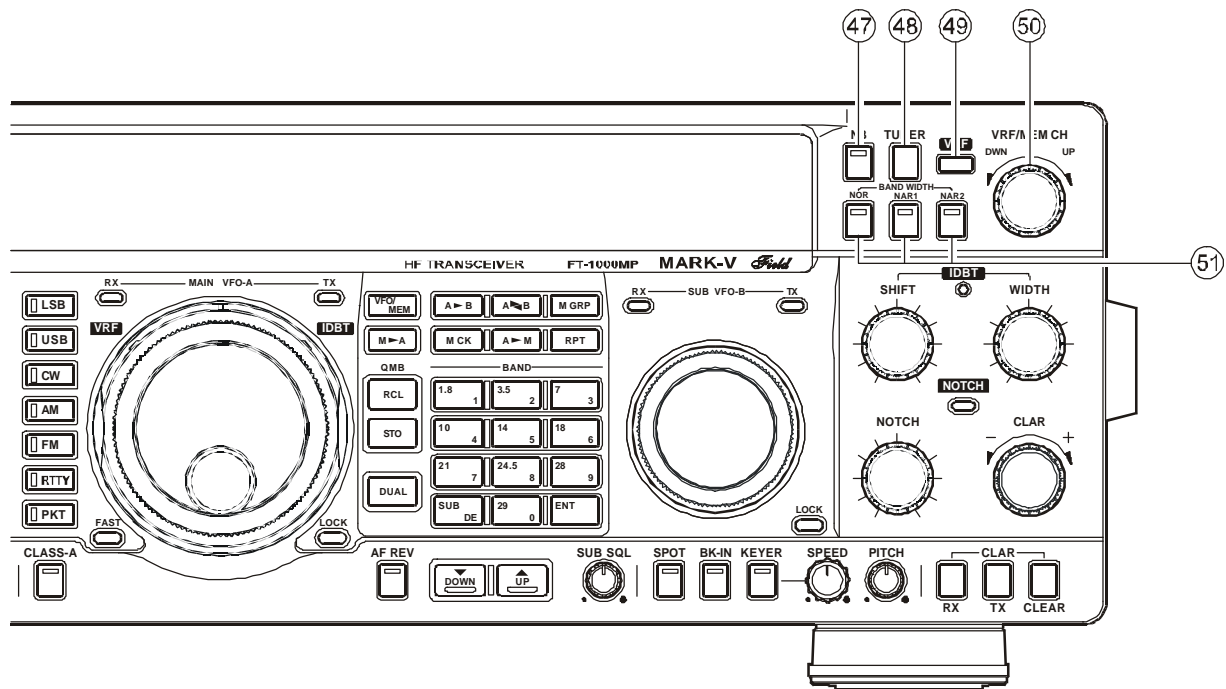

47 NB Button

Pressing this button activates the IF Noise Blanker, which may help reduce many different types of man-made impulse noise (but not atmospheric). When the Noise Blanker is activated, the LED inside button will glow red.

You can select the Noise Blanker Type (for short-duration pulses or for long-duration pulses) and its blanking level via *menu selection 2-8*.

48 [TUNER] Button

This is the on/off switch for the **MARK-V FT-1000MP Field's** Automatic Antenna Tuner.

Pressing this button momentarily places the antenna tuner in line between the transmitter final amplifier and the main antenna jack. Reception is not affected.

Pressing and holding this button for 1/2 second while receiving in an amateur band activates the transmitter for a few seconds while the automatic antenna tuner rematches the antenna system impedance for minimum SWR. The resulting settings are automatically stored in one of the antenna tuner's 39 memories, for instant automatic recall later when the receiver is tuned near the same frequency.

49 VRF Indicator

This indicator glows red when the **VRF** feature is activated by pressing the **[VRF]** button on the **Shuttle Jog**.

50 VRF/MEM CH Knob

When the **VRF** feature is engaged, use this detented knob to tune the passband of the narrow input preselector filter manually for maximum receiver sensitivity (and out-of-band interference rejection).

At other times (when the **VRF** feature is "off"), this knob selects the operating memory channel when the memories are active (but not retuned). When the VFO or memory tune functions of the main display are active, turning this knob causes the Sub VFO display to temporarily show the frequencies of the memories (memory check), without otherwise affecting operation. The channel number of the selected memory is displayed at all times at the center right of the display (in front of "CH").

Pressing and holding this knob for 1/2 second enables the "VFO Step" feature, which allows "channellizing" the VFO for quick frequency navigation. *Menu Selection 1-5* sets the VFO Channel step size.

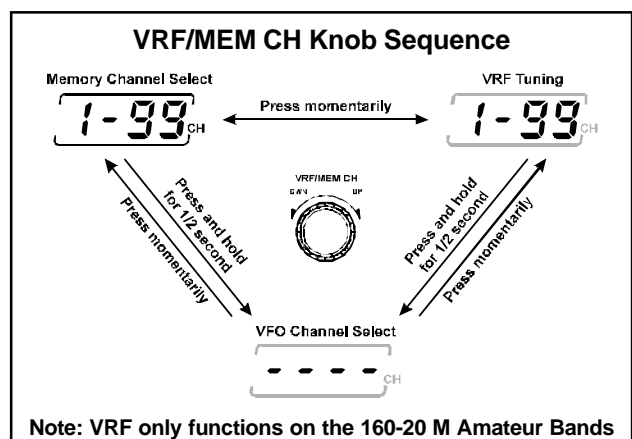

⑤1 BANDWIDTH Buttons (NOR/NAR1/NAR2) Buttons

These three buttons select the 2nd and 3rd IF filters for the receiver (except in the FM mode). The LED inside each button glows red when the corresponding bandwidth is selected.

The available 2nd and 3rd IF filters are as follows:

2nd and 3rd IF Filter Bandwidth

MODE	NOR		NAR 1		NAR 2	
	2nd IF (8.2MHz)	3rd IF (455 kHz)	2nd IF (8.2MHz)	3rd IF (455 kHz)	2nd IF (8.2MHz)	3rd IF (455 kHz)
SSB	2.4 kHz/ATT*1	2.4/6.0 kHz*1	2.0 (2.4) kHz	2.0 (2.4) kHz	N/A (2.0 kHz)	N/A (2.0 kHz)
CW	2.0/2.4 kHz*2	2.0/2.4 kHz*2	500 Hz	500 Hz	250 Hz	250 Hz
AM	ATT	6.0 kHz	2.4 kHz	2.4 kHz	2.0 kHz	2.0 kHz
RTTY/PKT/USER	2.4 kHz	2.4 kHz	2.0 kHz	2.0 kHz	250/500 Hz*3	250/500 Hz*3

※1: You can select the bandwidth via *menu selection 5-0*. The first value (bandwidth) is factory default.

※2: You can select the bandwidth via *menu selection 5-2*. The first value (bandwidth) is factory default.

※3: You can select the bandwidth via *menu selection 5-4*. The first value (bandwidth) is factory default.

Note 1 - In the factory default condition (*menu selection 5-0* set to "OFF"), the SSB **NAR 1** bandwidth is "2.0 kHz/2.0 kHz (2nd IF/3rd IF)" and the SSB **NAR 2** bandwidth is disabled. If you set the SSB **NOR** bandwidth to "ATT/6.0 kHz (2nd IF/3rd IF)" via *menu selection 5-0*, the **NAR 1** bandwidth will be set to "2.4 kHz/2.4 kHz (2nd IF/3rd IF)" and the **NAR 2** bandwidth will be set to "2.0 kHz/2.0 kHz (2nd IF/3rd IF)" automatically.

Note 2 - The 2nd IF (8.2 MHz) 2.0-kHz BW filter (Yaesu P/N **YF-114SN**) and 250 Hz BW filter (Yaesu P/N **YF-114CN**) and 3rd IF (455 kHz) 2.0-kHz BW filter (Yaesu P/N **YF-110SN**), 500 Hz BW filter (Yaesu P/N **YF-115C**) and 250 Hz BW filter (Yaesu P/N **YF-110CN**) are option.

Note 3 - The Sub Receiver uses a double-conversion circuit with 47.21 MHz and 455 kHz intermediate frequencies. Both the 6.0 kHz and 2.4 kHz filters are selected automatically according to mode, and with the optional 500 Hz Collins mechanical filter (Yaesu P/N **YF-115C**) installed and enabled via menu programming, it can be selected for CW operation.

LCD BARGRAPH METER INDICATIONS

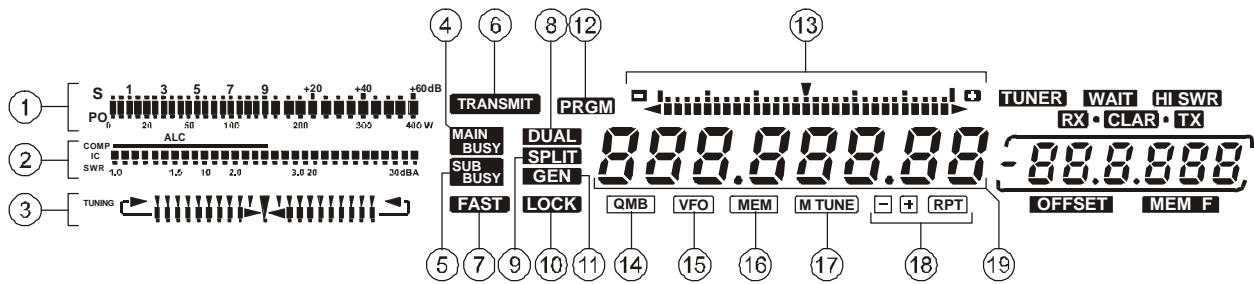

① S/P Scale

Thirty-one bargraph segments indicate relative received signal strength (one S-unit = 6 dB) from S-0 to S9 +60 dB. On transmit, RF power output from 0 to 400 Watts is displayed.

② IC/SWR/ALC/COMP Scale

Indicates final amplifier collector current (IC) from 0 to 30 amps, standing wave ratio (SWR) from 1.0 to 3.0, speech compression from 0 to 30 dB, ALC (automatic level control) operating range, DC supply voltage level, or microphone audio input level.

③ Tuning Scale

This multi-function tuning scale provides a center tuning segment for zero beating CW stations, and twin bars (“goal posts”) for accurate tuning of mark and space tones associated with digital modes, such as RTTY, Packet, and AMTOR.

④ MAIN BUSY

This appears whenever the Main receiver squelch is open (VFO-A).

⑤ SUB BUSY

This appears whenever the Sub receiver squelch is open (VFO-B).

⑥ TRANSMIT

This appears when the PTT is keyed and transmission is occurring. If transmission is inhibited for some reason (for example, attempting to transmit outside an amateur band), this indicator will blink.

⑦ FAST

Fast VFO tuning rate is active.

⑧ DUAL

This indicates that dual-receive operation is activated.

⑨ SPLIT

This indicator appears whenever split-frequency operation is activated.

⑩ LOCK

Front panel tuning knob and/or buttons are locked.

⑪ GEN

This appears whenever general coverage tuning is selected (when tuning outside an amateur band).

⑫ PRGM

Appears while tuning within programmed frequency limits in the PMS (Programmed Memory Scan) mode.

⑬ Tuning Offset Scale

Displays sub-resolution tuning steps or Clarifier offset in segmented increments.

When the VRF feature is engaged, this scale displays the peak position for the narrow-band “preselector” filter.

⑭ QMB (Quick Memory Bank)

This indicates that stored memories from the Quick Memory Bank are active for recall and operation.

⑮ VFO

VFO operation is selected.

⑯ MEM

This indicator shows that memory operation is selected (by pressing the [VFO/MR] button).

⑰ M TUNE

Appears while retuning the frequency of a selected memory channel.

⑱ -/RPT/+

One of these segments lights, along with the “RPT” indicator, when the “repeater mode” function is activated in the FM mode, indicating the direction of TX offset.

⑲ Frequency Display

This displays the current operating frequency, and also provides alphanumeric character display of programming menu selections and settings.

LCD BARGRAPH METER INDICATIONS

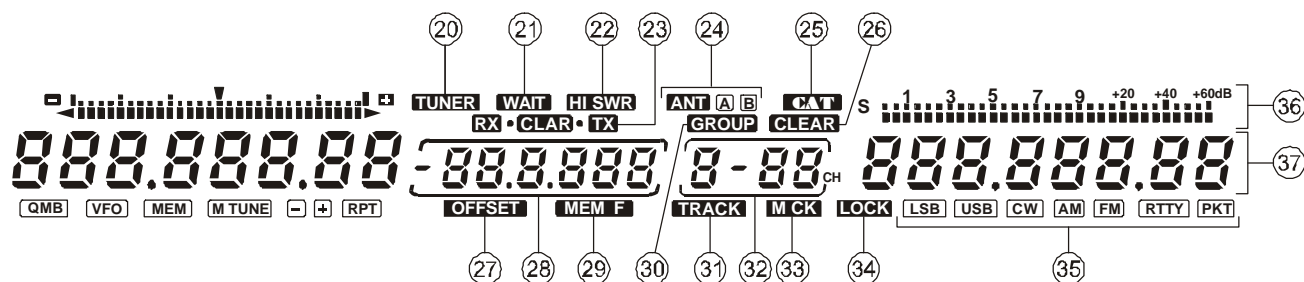

20 TUNER

This indicator comes on when the automatic antenna tuner (ATU) is activated and in-line.

21 WAIT

Appears when the ATU is seeking the best impedance match with the antenna. It also flashes each time the transceiver microprocessor sends frequency update data to the ATU microprocessor (while you tune).

22 HI SWR

Appears when an abnormally high SWR condition exists that cannot be matched below 3.0:1.

23 RX/CLAR/TX

These appear indicating the selected Clarifier function (Rx, Tx or both). The Clarifier offset frequency ± 9.99 kHz is shown in the sub-display immediately to the right.

24 ANT A/B

Indicates the antenna selected for operation (A or B) by the front panel ANT [A/B] switch (see item 18 on page 23).

25 CAT

External computer control of the transceiver is active. This indicator may appear to “blink” periodically if your software “polls” the transceiver every few seconds (for example, to confirm the current operating frequency).

26 CLEAR

Indicates the selected memory channel is not yet filled with data.

27 OFFSET

When enabled, this field shows the frequency difference (split offset) between Main VFO-A and Sub VFO-B.

28 Multi-Display Window

Displays either the Clarifier offset, memory channel frequency, split frequency offset, or CW pitch.

29 MEM F

Appears when the memory channel frequency appears in the multi-display panel.

30 GROUP

When the [M GRP] button is pressed, this indicates that the “memory recall” mode is engaged, and that scanning is limited to those memories in the currently-selected group.

31 TRACK

Appears when the VFO Tracking feature is activated.

32 Memory Channel Box

During normal operation, the currently-selected memory group and memory channel number appear here. With the Menu Programming mode active, menu selection numbers are displayed.

33 M CK

Appears when the Memory Check mode is activated.

34 LOCK

Appears when the Sub VFO tuning knob is disabled (it still turns but does nothing).

35 Sub Receiver MODE

Displays the currently-selected operating mode for the Sub receiver.

36 Sub Receiver S-Meter

Displays relative signal strength.

37 Sub Receiver Frequency Display

Displays the current sub-receiver frequency used during dual receive operation, and the transmit frequency during most split operation.

⑨ **VR6812**

This control adjusts the tuning meter segment indications.

Do not adjust this control, by mistake, as this control will adversely affect meter tuning indication, and requires factory re-alignment!.

⑩ **HPB-M**

This control sets the audio level available from the main receiver to headphone jack **B** (¼-inch plug).

⑪ **HPB-S**

This control sets the audio level available from the sub receiver to headphone jack **B** (¼-inch plug).

⑫ **HPA-M**

This control sets the audio level available from the main receiver to headphone jack **A** (3.5 mm plug).

⑬ **HPA-S**

This control sets the audio level available from the sub receiver to headphone jack **A** (3.5 mm plug).

Additional Note

The volume of the beep that sounds when a front-panel button is pushed can be adjusted by turning a trimmer accessed via the small hole on the bottom cover of the transceiver. Insert a small, thin, insulated, flat screwdriver into the hole to adjust **VR3001** for the desired beep volume. The Beep tone *frequency* is adjusted via *menu selection 4-2*; see page 101.

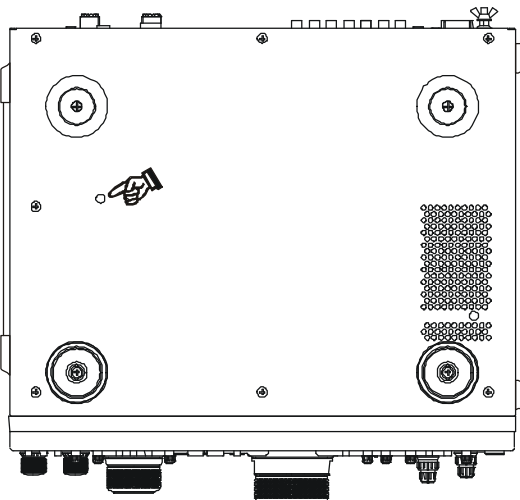

REAR PANEL CONTROLS & CONNECTORS

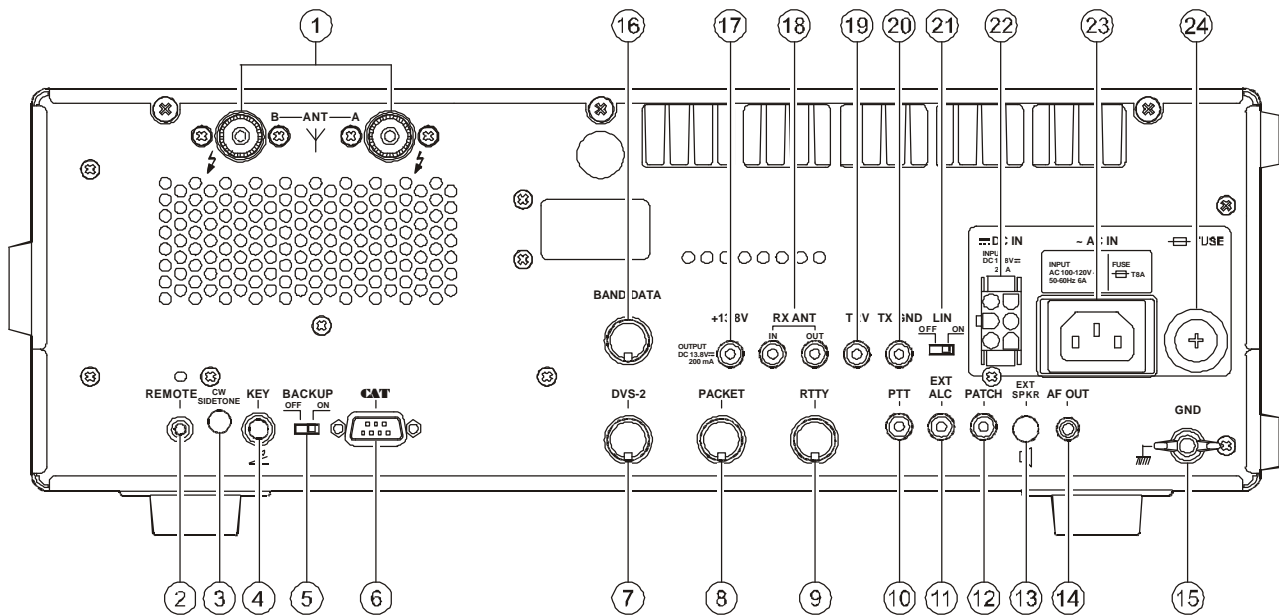

① ANT Coaxial Jacks

Connect your main antenna(s) here, using a type-**M** (PL-259) plug and coaxial feedline. These antenna ports are always used for transmission, and also are used for reception unless a separate receive antenna is also used for the main receiver. The internal antenna tuner affects only the antenna(s) connected here, and only during transmission.

② REMOTE Jack

By plugging in a remote control keypad here, direct access to the **MARK-V FT-1000MP Field** CPU is provided for control functions such as contest memory keying, frequency, and function control. This jack may also be also used for remote control of the **VL-1000** Linear Amplifier, if used.

③ CW SIDETONE Trimmer

Insert a small insulated screwdriver here and turn the trimmer inside to adjust the volume of the sidetone heard during CW keying (and when the **[SPOT]** button is pressed).

④ KEY 3-Contact Phone Jack

This ¼-inch phone jack accepts a CW key or keyer paddle. It is connected in parallel with the jack with the same name on the front panel (either or both may be used). A 2-contact plug cannot be used in this jack. Key-up voltage is +5 V, and key-down current is 0.5 mA. Plug wiring is shown on page 4.

⑤ BACKUP Slide Switch

Keep this switch in the "ON" position to retain all memory and VFO settings during power-off periods. There is no need to turn this switch off unless you plan to store the transceiver for a long period without use.

⑥ CAT Serial DB-9 Jack

This 9-pin serial DB-9 jack allows external computer control of the **MARK-V FT-1000MP Field**. Connect a serial cable here and to the RS-232C COM port on your personal computer (no external interface is required). **CAT** command protocol and data formats are described in the **CAT** chapter, starting on page 86.

⑦ DVS-2 DIN Jack

This 7-pin input/output jack is for connection of the **DVS-2** Digital Voice Recording option, described on page 81.

⑧ PACKET DIN Jack

This 5-pin input/output jack provides receiver audio and squelch signals, and accepts transmit (AFSK) audio and PTT control, from an external Packet TNC. Pinout is shown on pages 4 and 16. The receiver audio level at this jack is approximately 100 mV (@600 Ohms), preset by **VR3010** on the AF Unit (see page 15 for access to this trimmer, if necessary).

⑨ RTTY DIN Jack

This 4-pin input/output jack provides connections for an RTTY terminal unit. Pinout is shown on pages 4 and 17. The receiver audio level at this jack is at a constant 100-mV (@600 Ohms) level. FSK keying at this jack is accomplished by a closure of the SHIFT line to ground by the terminal unit.

⑩ PTT Phono Jack

This input jack may be used to provide manual transmitter activation using a footswitch or other switching device. Its function is identical to the **[MOX]** button on the front panel. The same line is available at the **PACKET** and **RTTY** jacks for TNC control. Open-circuit voltage is +13.8 VDC, and closed-circuit current is 1.5 mA.

⑪ EXT ALC Phono Jack

This input jack accepts negative-going external ALC (Automatic Level Control) voltage from a linear amplifier, to prevent over-excitation by the transceiver. Acceptable input voltage range is 0 to -4 VDC.

⑫ PATCH Phono Jack

This input jack accepts transmitter audio - either AFSK or voice - for transmission. This line is mixed with the microphone audio input line, so the microphone should be disconnected if using this jack and mixing is not desired. Impedance is 500 ~ 600 Ohms.

⑬ EXT SPKR Mini Phone Jack

This 2-contact output jack provides mixed receiver audio for an external loudspeaker, such as the **SP-8**. Inserting a plug into this jack disables the internal loudspeaker. Impedance is 4 ~ 8 Ohms.

⑭ AF OUT Mini Phone Jack

This 3-contact jack provides dual-channel low-level receiver output, for recording or external amplification. Peak signal level is 100 mVrms at 600 Ohms. Main receiver audio is on the left channel (tip), and sub receiver audio is on the right channel (ring). A stereo amplifier or recorder is recommended, to record each receiver's audio separately when dual reception is enabled. The front panel **AF GAIN** controls and the [**AF REV**] switch setting do not affect the signals at this jack.

⑮ GND Terminal Post

Use this terminal to connect the transceiver to a good earth ground, for safety and optimum performance. Use a large diameter, short braided cable.

⑯ BAND DATA DIN Jack

This 8-pin output jack provides control signals for the **FL-7000/VL-1000** Solid-State Linear Amplifier, including band selection data to automatically set the Linear or Tuner to the same band as the main display of the transceiver. Band Data jack connections are shown on page 4.

⑰ +13.8V Phono Jack

This output jack provides regulated, separately fused 13.8 VDC at up to 200 mA, to power an external device such as a packet TNC. Make sure your device does not require more current (if it does, use a separate power source). Attempting to draw more power from here will shut down the internal circuit breaker. If this happens, the circuit breaker will automatically reset a few seconds after the device drawing excessive current is disconnected.

⑱ RX ANT Phono Jacks (In/Out)

These antenna jacks are provided for connection for a separate receive-only antenna, activated when the switch with the same name on the front panel is pressed. An antenna connected here can be used by both the Main and Sub Receivers.

⑲ TRV Transverter Drive Output Jack

This jack provides a low level RF output for use with a transverter. Maximum output is approximately 100 mVrms at 50 Ohms (-6 dBm).

⑳ TX GND Jack (normally disabled)

When enabled by the [**LIN**] switch, this output jack connects inside the **MARK-V FT-1000MP Field** to a set of relay contacts which short together (to chassis ground) whenever the transmitter is active. This allows transmit/receive switching of an external device such as a linear amplifier. This jack is disabled at the factory, to avoid the clicking of the relay when it is not used.

Maximum ratings for these relay contacts are 500 mA @ 100 VAC, 200 mA @ 60 VDC or 1 A @ 30 VDC. Before connecting an external device, make sure its switching requirements will not exceed these limits. If your amplifier requires higher current, or has higher voltage switching requirements, an external switching device must be used.

㉑ LIN Linear Amplifier Relay Switch

To enable the **TX GND** jack when you are connecting an external linear amplifier, move this switch to its "**ON**" position.

㉒ DC IN Jack

This 6-pin molex socket accepts DC input power to the transceiver when AC is not available.

㉓ ~AC IN Jack

Connect the supplied AC line code to this socket after ensuring that your AC main voltage matches that on the label. See page 116 for instructions on how to change the internal switching power supply AC mains voltage, if necessary.

㉔ FUSE Holder

This holder requires an 8-A fuse for operation from AC voltages below 120 V, and a 4-A fuse for AC voltages of 200 V and above. Only normal fast-blow type fuses should be used here.

OPERATION

BEFORE STARTING

Before plugging in the transceiver, check your installation to make sure your AC voltage is correct, and that your ground and antenna are connected as described in the Installation chapter. Then preset the following controls as indicated:

[POWER], [ANT RX], [MOX], [VOX], and [AF REV] buttons all *off*

AGC selector to *AUTO*

[IPO] button to *off*

AF GAIN and SUB AF knobs matched at approximately *9 o'clock*

MIC, PROC, RF PWR, MONI, SQL, SUB SQL, and NB knobs all *counterclockwise*

RF GAIN knob fully *clockwise*

SHIFT, WIDTH, and NOTCH knobs *12 o'clock* (dent)

[LOCK], [FAST], [SPOT], [BK-IN], and [KEYER] switches all *off*.

Connect your microphone and CW key/paddle, then plug the AC cord into the wall outlet.

MARK-V FT-1000MP *FIELD* MENU PROGRAMMING

The **MARK-V FT-1000MP *Field*** incorporates a wealth of operating functions and features. For flexibility in configuring these capabilities, and to keep the front panel controls to a minimum, an internal Menu Programming routine is used. This allows customizing the functions via menu selections that previously required many elaborate DIP switch settings, power-on/button holding routines, or additional front and rear panel controls/switches. This permits each rig to have a custom “personality” that specifically matches your operating requirements, with the capability for easy modification as your requirements change.

Menu programming is enabled by holding in the [FAST] button, and pressing the [ENT] key while holding in [FAST]. You may then rotate the VRF/MEM CH knob to display the desired setting. Each of the settings can be changed or customized, as you like, in this mode. For clarity's sake, transceiver functions that have several settings or options are referenced to the Menu Programming chapter separately, where details of programming are covered. Descriptions for most transceiver functions in this chapter assume default (factory-configured) transceiver settings.

There also are some “short-cuts” to certain Menu settings, and these will be described in the appropriate chapters to follow.

RECEIVING

Note: the following procedure assumes the transceiver has not been used before, and not already set for Dual reception. If “DUAL” appears on the display when you switch on the set in the next step, you should press the blue [DUAL] button to return to the single-receiver mode (for now).

Press the [POWER] switch on. The meter and display should light up (although it may take a few seconds for the display to appear as it initializes). If the display is too bright for your taste, it can be switched to a more subdued level using *menu selection 3-4* (see page 100).

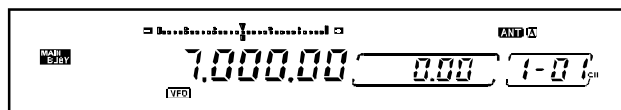

Take a moment to study the display. You should see “VFO” at the bottom, with the operating frequency of the Main VFO just above the main tuning knob. To the right of that is the Clarifier offset (“0.00”), followed by the memory channel number (“1-01” CH by default). At the right side of the display are the current mode and frequency of SUB VFO-B, which we’ll talk about later.

AMATEUR BAND SELECTION

Press a keypad key (between the two tuning knobs) to select a band for which your antenna is designed. Refer to the white “MHz” labels, and press the appropriate one.

BAND		
1.8 1	3.5 2	7 3
10 4	14 5	18 6
21 7	24.5 8	28 9
SUB CE	29 0	ENT

Key Beeper

Pressing a front-panel button normally produces a beep. Its volume is independent of receiver volume, and can be set by adjusting a trimmer via a hole on the bottom panel of the transceiver case.

To change the pitch of the beeper, recall *menu selection 4-2* (page 101) and select the desired pitch (between 220 and 7040 Hz) by turning the dial. You can also disable the beeper via *menu selection 4-1* (also page 101).

RECEIVING

MODE SELECTION

Press the [MODE] button (to the left of the main tuning knob) corresponding to the mode you wish to operate - for now, we suggest an SSB mode: USB if you have selected a band above 10 MHz, or LSB otherwise. The green LED in each button indicates the selected band, and a pair of LEDs within the bandwidth panel (to the left of the mode buttons) indicate which IF filter pair is currently selected for that mode.



CW and RTTY have “reverse” modes that are selected by pressing their button twice (see the box at the right), and AM Synchronous tuning is activated in the same manner. Also, Packet operation can be toggled between LSB and FM (for 29 MHz operation) in the same way. These special features are covered later.

Pressing and holding the [PKT] key for one second activates the user-programmed operating mode (“*User Set*”). Be sure to page 80 for more details on user-programmed operating mode.

Additionally, notice that the bargraph meter format changes to the appropriate tuning display for the selected mode (covered later).

If you have selected an SSB mode, the red LED in the [NOR] button should be lit. If not, press [NOR] key. This bandwidth provides good fidelity for SSB reception and should be used unless QRM from stations on adjacent frequencies becomes a problem (as described later).

Adjust the **AF GAIN** knob for comfortable volume on signals or noise in the loudspeaker or headphones. The small **SUB AF** knob (to the under the **AF GAIN** knob) is used with the Sub VFO operation and is explained in greater detail later.

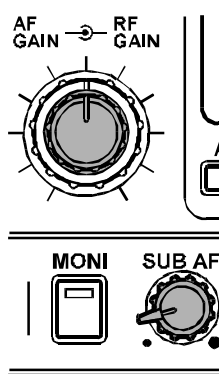

Special Note for CW Mode (Reverse CW sideband)

When you switch modes between CW and USB, you may notice that the frequency of received signal stays the same (even though the panel frequency may change slightly). Also notice that the pitch of a received signal decreases as you increase the dial frequency.

However, switching to LSB from CW normally requires retuning the desired station. This can be especially inconvenient if you enjoy working the lower HF bands (40 meters and below) where LSB mode is used.

To eliminate the need for retuning in this situation, you may switch the receiver CW carrier oscillator injection to the reverse side (LSB). When you press [CW] button, you should notice that the green LED in the USB mode button blinks for a second or two. This informs you of the default carrier offset (upper) for CW. To switch to lower injection side, simply press the [CW] button again; you will see the displayed frequency shift and the LSB LED will blink.

When using the reverse sideband (LSB) for CW reception, you can freely switch between LSB and CW without having to retune a station. Note that in LSB and CW modes the received signal pitch now increases as you increase the dial frequency.

To return the receiver to the default (upper) sideband, simply press [CW] again.

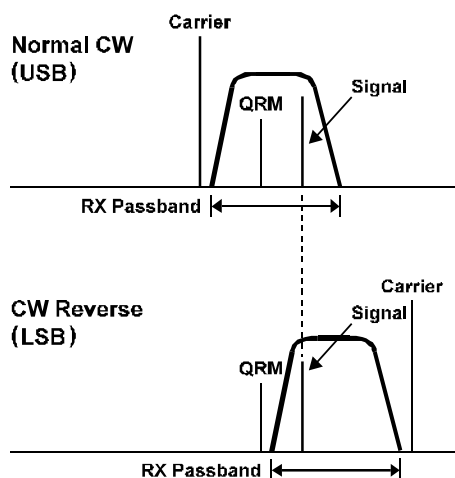

Operating Hint - An added benefit from this feature is QRM rejection. If you have interference on a CW station that the IF SHIFT does not easily eliminate, you can try switching to the reverse sideband, retuning the signal, and trying the IF SHIFT again.

RECEIVING

TUNING THE MARK-V FT-1000MP *FIELD*

Tuning is accomplished in several ways, with each method having its own advantages; they are:

- Main & Sub VFO Knob Tuning
- Shuttle Jog Tuning
- Panel & Microphone Down/Up keys
- VFO Channel Stepping

VFO Knob

Rotating the Main VFO-A knob tunes the transceiver according to the selected tuning step size and encoder tuning rate. Both of these settings are configured via *menu selections 1-3 & 1-4* (see page 99). The table below shows the available tuning step sizes and their default settings.

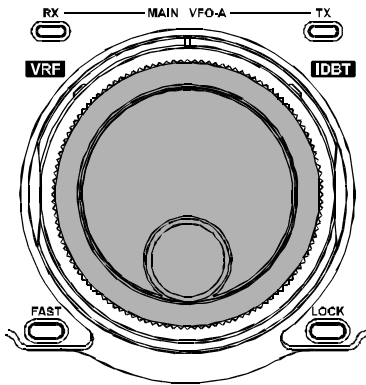

Control	Tuning Steps	Default Step
MAIN VFO-A knob	0.625/1.25/2.5/	10 Hz
SUB VFO-B knob	5/10/20 Hz	
Shuttle Jog	13 preset	–
DOWN(▼)/UP(▲) Pushbuttons	Normal	100 kHz
	w/[FAST] knob	1 MHz
VRF/MEM CH CH. Stepping	Normal	10 kHz
CLAR (Clarifier)	0.625/1.25/2.5/	10 Hz
	5/10/20 Hz	

For faster dial tuning rates with either the VFO knob or mic UP/DOWN buttons, press the [FAST] button below and to the left of the Main VFO knob (“FAST” appears). This selects the VFO speed, which can be switched between 4x (default) and 2x in *menu selection 1-0* (see page 99). This affects the ΔF per VFO knob rotation without changing the default tuning step size.

Default Tuning Step	ΔF for 1 revolution of VFO knob			
	(X2) Encoder Rate		(X4) Encoder Rate	
	Normal	FAST	Normal	FAST
0.625 Hz	312 Hz	3.12 kHz	625 Hz	6.25 kHz
1.25 Hz	625 Hz	6.25 kHz	1.25 kHz	12.5 kHz
2.5 Hz	1.25 Hz	12.5 kHz	2.5 kHz	25 kHz
5 Hz	2.5 Hz	25 kHz	5 kHz	50 kHz
10 Hz	5 Hz	50 kHz	10 kHz	100 kHz
20 Hz	10 Hz	100 kHz	20 kHz	200 kHz

Shuttle Jog

The **Shuttle Jog** ring is more efficient for large frequency excursions, or whenever QSY requires spinning the VFO knob a lot, while still providing positive control with a comfortable feel.

Rotating the **Shuttle Jog** away from the center detent in either direction starts constant tuning. The farther the **Shuttle Jog** is moved from center, the larger the progressive frequency steps (and QSY). There are 13 preset frequency steps incrementing through the arc of the **Shuttle Jog** (from 10 Hz ~ 100 kHz). The **Shuttle Jog** speed (encoder rate) is also configurable from 1 ~ 100 msec. via *menu selection 1-1* on page 99.

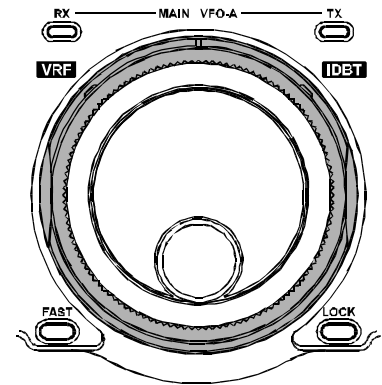

Recall that the step size varies as the **Shuttle Jog** is turned, while the encoder rate is fixed. The effect of tuning faster as the **Shuttle Jog** is rotated actually comes from jumping to progressively larger tuning increments, as encoder rate remains constant.

FAST Button Operation

By default, the front panel [FAST] button is a press-on, press-off type. However, you can change it to a momentary type by recalling *menu selection 8-0* (see page 104) and changing the default setting.

RECEIVING

Panel Up/Down Buttons

Press the large **UP**(▲) and **DOWN**(▼) buttons below the keypad to step around the band in 100-kHz steps, and then tune around the band a bit with the tuning knob.



If the “**FAST**” icon appears on the display, pressing these buttons will cause stepping in 1 MHz increments.

Microphone Up/Dwn Buttons

If your microphone has **UP** and **DWN** buttons, (such as the **MH-31B8D**) you can press them momentarily to tune in 10-Hz steps, or hold them to start VFO scanning. If it has a **FST** button, you can use it to duplicate the function of the [**FAST**] key on the transceiver front panel.

VFO Channel Stepping

This feature utilizes the **VRF/MEM CH** knob at the upper right corner, and is unique because it allows “channellizing” the VFO for quick, yet precise, frequency navigation. For example, setting this feature to 1 kHz provides an easy way of stepping around an SSB band, looking for activity. Many bands such as AM broadcast, HF maritime, aeronautical, and citizen’s band incorporate assigned channels using discrete frequency steps. By configuring this feature for the service in interest, you can hop from one channel to the next without having to zero in (manually) each station’s signal with the VFO knob.

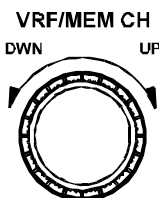

To enable operation using the VFO Step feature, it first must be enabled by pressing and holding in the **VRF/MEM CH** knob for ½ second.

Once enabled, rotate the **VRF/MEM CH** knob as you would to tune a channelized FM rig. While VFO channel stepping is enabled, “- - -” appears in the channel number display, until the knob is pressed in again to disable channel stepping. Channel stepping is configured by *menu selection 1-5* on page 99; also see General Coverage Reception.

To disable the VFO Step feature, just press the **VRF/MEM CH** knob momentarily.

Display Settings

Display Mode - By default, switching to and from CW, PKT or RTTY modes causes the display to change by the amount of offset selected by the CW PITCH (page 56), RTTY, and PKT tone & offset configurations (pages 15 and 16). If you prefer the display to remain unchanged when switching modes, this can be done by setting *menu selection 3-0* to BFO (carrier) display on page 100. However, the actual carrier offsets configured by the menu selections, relative to the display and IF bandpass are unaffected, regardless of the setting for *menu selection 3-0*.

Display Resolution - Although the **MARK-V FT-1000MP Field** DDS (Direct Digital Synthesizer) tunes in frequency increments as small as .625 Hz, display resolution is limited to 10 Hz. The 10 Hz and 100 Hz digits display can be turned off, as desired, if smaller frequency resolution is not needed (tuning steps are not affected).

Select the desired display resolution via *menu selection 3-1* on page 100.

7.000.00	10 Hz Resolution
7.000.0	100 Hz Resolution
7.000	1 kHz Resolution

VFO & Panel Locking Schemes

The locking scheme for the MAIN VFO-A [**LOCK**] button offers three choices. By default, pressing the [**LOCK**] button so that “**LOCK**” appears only disables the tuning knob (it still turns, but does nothing). However, it can disable all front panel keys, or else all except the primary function keys. To select the locking scheme, recall *menu function 8-1*, as shown on page 104.

Important! - Holding the [**LOCK**] button without releasing it activates the dual VFO tracking feature, which is discussed later in the chapter.

RECEIVING

ALTERNATE VFO OPERATION

("FRONT & REAR" VFO)

If you press the keypad band key for the same band that you are already operating on, the display will shift to a different frequency in the same band (the bottom of the band by default). Pressing the same band key again switches you back to the frequency you were on before. What you have here are two completely independent VFO selections for each band, selectable by each band's keypad key. You can think of the VFO for every band having a "front" and "rear" half that can be swapped for operation by toggling the band key. You can tune, select a mode and a bandwidth for each of these two VFO halves in each band, and they will be remembered until you return to this "sub receiver" selection.

Toggle VFOs

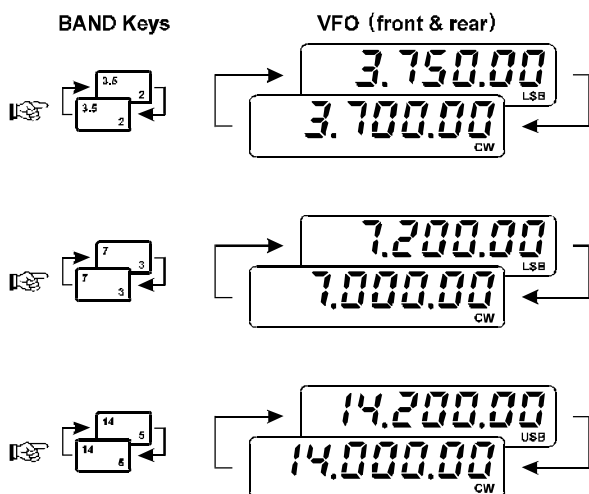

A practical use of this feature is to configure the front VFO for phone operation, and the rear half for CW operation on the same band (see the illustration above).

For example, if one of your VFOs is set to the SSB portion of the band (and in an SSB mode), press the keypad key for that same band, tune to the low end of the band, and press the [CW] mode button. You can consider this your CW VFO. Now press the band key again several times, and notice that operation toggles between the SSB and CW VFO halves. You can also select different IF bandwidths as well as modes for the two halves (and even different Clarifier settings). Note that this feature is not related to the MAIN VFO-A and SUB VFO-B scheme - dual receive and split operation will be covered later.

VFO SELECTION & RECEIVER MUTING

Above the Main and Sub VFO knobs are a pair of buttons/LEDs labeled **RX** and **TX**. The illuminated green "RX" LED indicates the VFO(s) controlling the receiver, while the red "TX" LED shows the VFO controlling the transmit frequency. As we will see later on in dual and split operation, these buttons can configure semi-duplex operation as you choose.

You can mute the Main or Sub VFO at any time by pressing the **RX** button/LED above the corresponding VFO knob. The LED blinks while the receiver remains muted; simply press the button again to unmute.

KEYPAD FREQUENCY ENTRY

Frequencies can be entered directly, if desired, as follows:

Press [ENT] at the lower right corner of the keypad (the leftmost operating frequency digit will blink). Then, referring to the yellow numbers on the keypad, enter the digits of the new frequency, from left to right (1 - 4 - 2 - 5 - 0 - 0 - 0), followed by [ENT] again. As you enter the numbers, the next digit to be entered will blink on the display. You can use the **DOWN**(▼) and **UP**(▲) buttons below the keypad to reposition the blinking digit location as desired (but ignore the direction labels on these buttons).

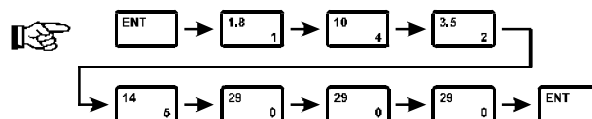

Only when you press [ENT] the second time will the operating frequency actually change, so if you decide to remain on the original frequency after starting to key in a new one, you can cancel any entered digits by pressing [SUB(CE)] ("Clear Entry," the yellow label at the lower left corner of the keypad) instead of [ENT]. Note that, to enter frequencies below 10 MHz, you *must* key in the leading zeros.

That's all there is to tuning Main VFO-A. Sub VFO-B has a lot more features of its own, which we'll look at in detail later. First, however, let's look at some other important receiver features.

RECEIVING

SIGNAL TUNING METER INDICATIONS

The **MARK-V FT-1000MP Field** incorporates several display indications that make tuning stations a simple and accurate task:

Tuning Scale - When either CW, RTTY or PKT operation is selected, the tuning meter appears beneath the IC/SWR meter scale, as shown below.

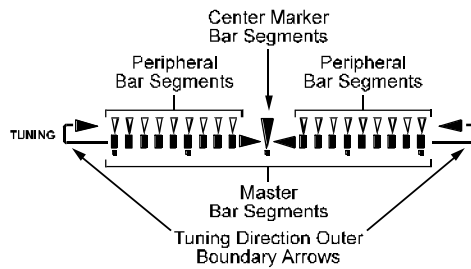

In the CW mode, when you tune a signal near the center of the receiver passband, the boundary arrows light, and the upper signal strength segments increase as you slowly tune the VFO knob. The idea is to tune for maximum indication, and so that a lone center marker illuminates in the lower tuning meter (the boundary arrows turn off when the marker is centered). If you detune, the arrows illuminate, indicating that you need to re-center the marker.

CW TUNING

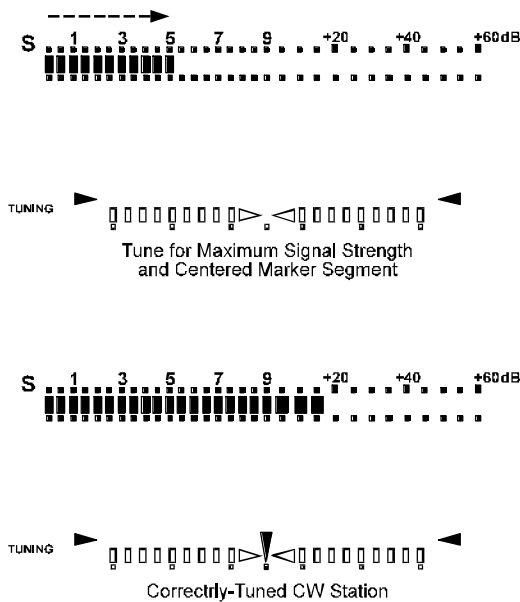

For RTTY and Packet, dual segments appear (representing the mark and space tones), and in this case optimum tuning is achieved when even balance and maximum separation between the dual segments occur. The minimum separation between the segments is proportional to the mark and space tone shift (170 Hz, 425 Hz or 850 Hz). We will cover more about RTTY and Packet operation later.

RTTY/PKT TUNING

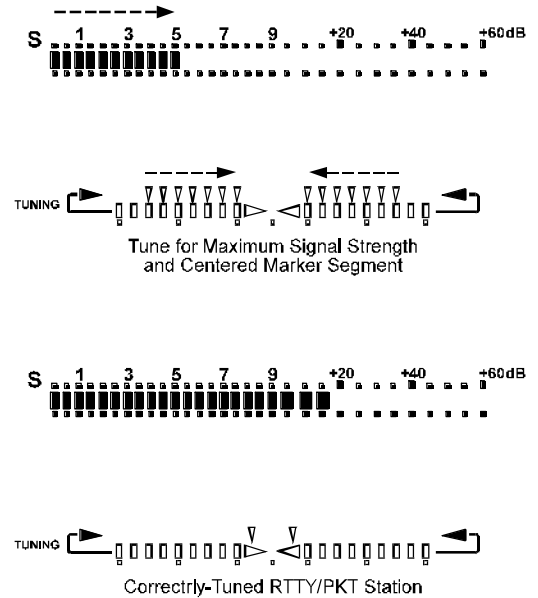

“Peak-Hold” Feature - During receive, the S-Meter segments respond instantaneously to the relative signal strength (in S-Units) of stations. The meter “peak-hold” circuitry keeps the right-most bargraph segment on for a user-selectable time delay from 10 msec up to 2 seconds. The peak-hold feature is off by default, but you can enable it and select the desired delay time via *menu function 3-7*.

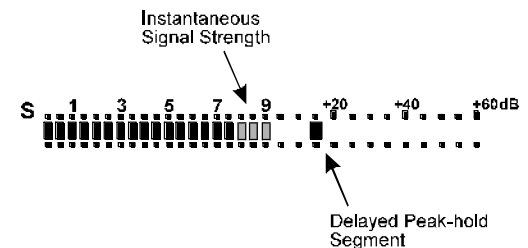

RECEIVING

EXPANDED TUNING SCALE

The bargraph segment meter above the MAIN VFO-A frequency display serves as a triple mode enhanced tuning scale. By default, it displays relative Clarifier offset, and as you rotate the **CLAR** knob (either Rx or Tx Clarifier), the normally centered marker segment moves left or right, indicating the relative displaced (“clarified”) Rx or Tx frequency from the original. Be sure to see page 49 for more details on Clarifier operation.

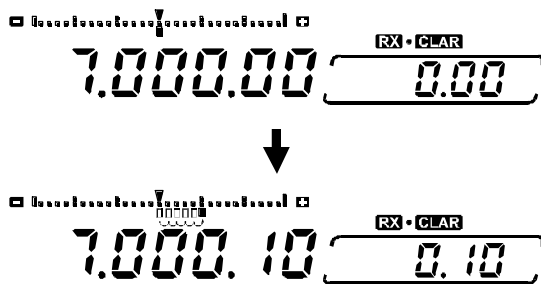

When the VRF feature is engaged, the segments briefly indicate the peak position for the narrow band-pass “preselector” when you are turning the **VRF/MEM CH** knob. Be sure to see page 44 for more details on VRF operation.

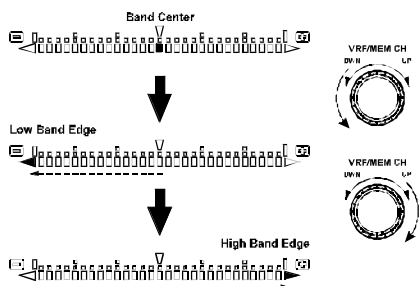

Alternately, you can have the segments expand outwardly as you tune either direction from the nearest displayed frequency. This lets you view tuning increments smaller than 10 Hz (the maximum display resolution).

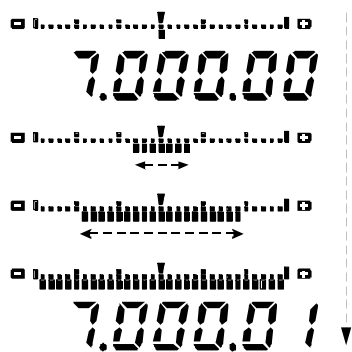

The rate and distance of segment displacement in either mode are proportional to the selected tuning step size and depend on whether or not the **[FAST]** button is engaged. The tuning meter mode is selected by *menu selection 3-2*.

AM SYNCHRONOUS TUNING

Audio distortion of AM stations due to carrier fading is common. Synchronous tuning reduces this phenomenon by receiving the station in “LSB” while *re-injecting* an unfading carrier. The benefit of this technique is that the re-injected carrier is phase-locked to carrier of the original station, reducing the effects of fading and improving signal fidelity over that of conventional AM detection.

To activate AM synchronous detection, press the **[AM]** button *twice* (so the green LED inside the button blinks). The tuning meter format changes to that below. Slowly tune across the signal until the lone center segment appears (see below).

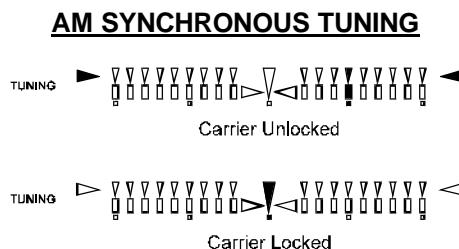

SUB-DISPLAY MODE SELECTION

The small window to the right of the main frequency display can contain several different readouts, selected by *menu selection 3-5*.

These include:

Clarifier - Displays “clarified” frequency as offset from the original frequency.



Channel Freq. - Displays the operating frequency contained in the current memory channel, providing “What if?” information while you are operating on a VFO.



Offset - Displays the frequency difference between the Main VFO and Sub VFO frequencies.



A1 (CW) Pitch - Displays the current CW pitch setting.

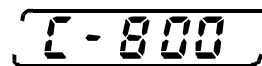

Whichever selection you choose, if you activate the Clarifier during operation, its display will over-ride any other (non-Clarifier) settings you may have set via *menu selection 3-5*.

RECEIVING

GENERAL COVERAGE RECEPTION

You may have already noticed that if you tune outside one of the amateur bands (actually, outside of the 500-kHz segment that includes each band), “**GEN**” appears in a box at the left side of the display. On such frequencies, the transmitter and antenna tuner are disabled. If you try to transmit, “**TRANSMIT**” will blink. This confirms that transmission has been inhibited by the microprocessor.

Also, such frequencies are ignored by the band selection keys, so if you tune a VFO to a frequency outside of a ham band, you will have to store it in a memory (as described on page 64) if you want to be able to recall it quickly later. Otherwise, as soon as you press a band key, the general coverage frequency will be lost as the VFO reverts to the (ham-band) frequency it was on when the band was last changed.

Once you become familiar with the memories, you will find this really doesn’t present a problem, as each memory can be tuned just like a VFO, and stored into another channel without having to go through a VFO.

Aside from the above, general coverage reception provides all of the features available on ham frequencies, including dual channel reception, digital modes, and diversity reception, described on the following pages. A wealth of interesting broadcasts can be found outside the amateur bands, including:

- International Shortwave Bands (see table)
- Maritime & Aeronautical Communications
- News Services & Diplomatic/Embassy Traffic
- Military Communications

While tuning outside an amateur band, you may find the **UP**(▲) and **DOWN**(▼) keys (below the keypad) to be extremely valuable for quick frequency change. The 100 kHz steps provided by these keys are ideal for moving quickly through, for example, the 15 MHz international AM broadcast band.

Note Regarding AM Broadcast Reception

In many countries, broadcast stations in the Standard AM Broadcast Band are separated by a spacing of 9 kHz. The VFO Channel mode of operation can be highly useful in this case, as you can set the VFO channel step size to 9 kHz. Use the Main VFO-A knob to set a starting frequency, then press and hold in the **VRF/MEM CH** knob for ½ second.

If “9 kHz” has been set via *menu selection 1-5*, you can now use the **VRF/MEM CH** knob to tune through the broadcast band in the desired 9 kHz steps.

POPULAR SHORTWAVE BROADCAST BANDS			
Meter Band	Frequency Range (MHz)	Meter Band	Frequency Range (MHz)
LW	0.150 ~ 0.285	31	9.350 ~ 9.900
MW	0.520 ~ 1.625	25	11.550 ~ 12.050
120	2.300 ~ 2.500	22	13.600 ~ 13.900
90	3.200 ~ 3.400	19	15.100 ~ 15.700
75	3.900 ~ 4.000	16	17.550 ~ 17.900
60	4.750 ~ 5.200	–	18.900 ~ 19.300
49	5.850 ~ 6.200	13	21.450 ~ 21.850
41	7.100 ~ 7.500	11	25.670 ~ 26.100

DEALING WITH INTERFERENCE

The **MARK-V FT-1000MP Field** includes a wide range of special features to suppress the many types of interference that may be encountered on the HF bands. However, real world interference conditions are constantly changing, so optimum setting of the controls is somewhat of an art, requiring familiarity with the types of interference and the subtle effects of some of the controls. Therefore, the following information is provided as general guidelines for typical situations, and a starting point for your own experimentation.

The **MARK-V FT-1000MP Field's** interference-fighting circuitry begins in its "RF" stages, and continues throughout the entire receiver section.

VRF (VARIABLE RF FRONT-END FILTER)

The **VRF** feature allows you to engage a narrow band-pass "preselector" filter into the receiver's RF circuit path. The added selectivity can be a tremendous help in minimizing potential interference from strong out-of-band signals, especially in a multi-transmitter operating environment.

To activate the **VRF** feature, press the [**VRF**] button on the **Shuttle Jog**, then turn the **VRF/MEM CH** knob to peak the signal or background noise level. When the **VRF** feature is engaged, the red "**VRF**" LED, located on the left side of the **VRF/MEM CH** knob, will be illuminated.

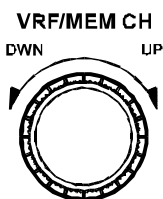

If a potentially-interfering signal is very near your current operating frequency (for example, an SSB station operating near 3.80 MHz while you are on 3.52 MHz), additional protection may be realized by deliberately mistuning the **VRF** so as to place more "roll-off" of the undesired signal. In this example, tuning the **VRF** for peak response at 3.40 MHz will cause additional attenuation to be placed on the strong signal at 3.80 MHz. Particularly on the lower frequency bands, there will be no loss of useful sensitivity with moderate de-tuning, but interference rejection will be significantly enhanced.

FRONT END SELECTIONS:

AMP SELECTION, IPO & ATT

The best receiver front-end selection will depend on background noise at the time, the presence or absence of strong signals, and whether or not you want to hear very weak signals. If the front end is set for too much gain, background noise will make listening difficult, and very strong signals on other frequencies may cause intermodulation interference, masking weaker signals. On the other hand, if the front end is set for too little gain (or too much attenuation), very weak signals will not be heard.

When evaluating the selections below, remember that if you can hear band noise increase when your antenna is connected, you have adequate sensitivity; any further early-stage gain is not needed.

"Wide Band" and "Tuned" Preamp Selection

Three high-performance FET RF amplifiers are utilized in the **MARK-V FT-1000MP Field** receiver front end. A single wide-band amp is provided for good general all-around performance, along with dual tuned amplifiers: one optimized for 24~30 MHz, the other for 1.8~7 MHz (see illustration). The Tuned preamp is especially useful when operating from a quiet location on 10 meters, while on the low bands the Tuned preamp's low gain provides optimum strong-signal performance. Each amplifier is selected automatically as you tune or change bands; however, you can disable the tuned amplifier pair and only use the wide-band amp via *menu selection 8-4*.

Note that the Tuned preamp only operates in the 1.8~7 and 24~30 amateur bands. If you tune outside of an amateur band while using the Tuned preamp, the transceiver will automatically switch over to the "Flat" (Wide-band) preamp. The effects of this design are:

(1) When tuning outside of a low-frequency amateur

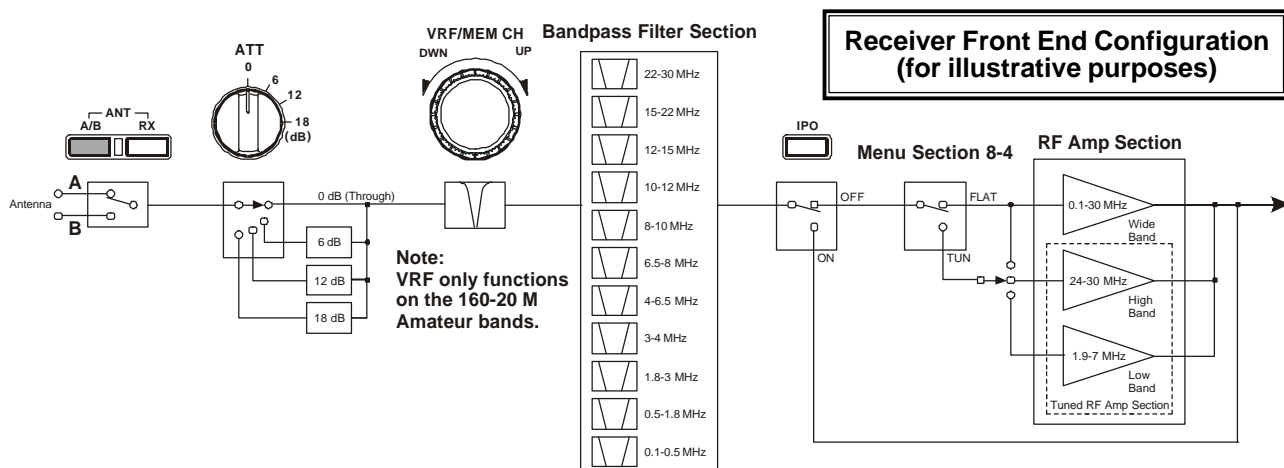

DEALING WITH INTERFERENCE

band (for example, tuning from 1.999.99 MHz to 2.000.00 MHz), the higher gain of the “Flat” preamp will cause the background noise to increase suddenly (and decrease again if you tune back inside the 160-meter band).

- (2) When tuning outside of a high-frequency amateur band (for example, tuning from 28.000.00 MHz to 27.999.99 MHz), the higher gain of the Tuned premap will cause the background noise to decrease suddenly (and increase again if you tune back inside the 10-meter band).

IPO (Intercept Point Optimization)

Normally, the front-end FET RF amplifiers provide maximum sensitivity for weak signals. During typical conditions on lower frequencies (such as strong overloading from signals on adjacent frequencies), the RF amplifiers can be bypassed by pressing the [IPO] button so the green LED is on. This improves the dynamic range and IMD (intermodulation distortion) characteristics of the receiver, at a slight reduction of sensitivity. On frequencies below about 10 MHz, you generally will want to keep the [IPO] button engaged, as the preamplifiers are usually not needed at these frequencies.



ATT (RF Attenuator)

Even with the IPO function on, extremely strong local signals can still degrade reception. So if you still notice the effects of overloading, or if the signals you want to listen to are very strong, you can use the **ATT** selector to insert 6, 12, or 18-dB of RF attenuation in front of the RF amplifier. If background noise causes the S-meter to deflect on clear channels, turn the **ATT** selector clockwise until the S-meter drops to about S-1 (the white area at the left end of the top meter scale). This setting optimizes the trade-off between sensitivity and interference immunity. Also, once you have tuned in a station you want to work, you may want to reduce sensitivity further (or add more attenuation) by turning the **ATT** control to a more clockwise setting. This reduces the strength of all signals (and noise) and can make reception more comfortable, important especially during long QSOs.

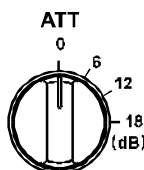

When looking for weak signals on a quiet band you will want maximum sensitivity, so the IPO should be disabled and the **ATT** selector should be set to “0.” This situation is typical during quiet times on frequencies above 21 MHz, and when using a small or negative-gain receiving antenna on other bands.

AGC (AUTOMATIC GAIN CONTROL) SELECTION

When tuning around the band looking for signals, the **AGC** selector is usually best kept in the “**AUTO**” position, where AGC decay is automatically selected according to the operating mode. You can manually select receiver AGC; however, a few points about AGC and receiver recovery time need to be pointed out.

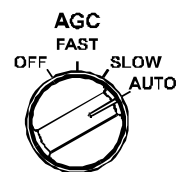

For SSB reception, the “**FAST**” position allows the receiver gain to recover quickly after tuning past strong signals or when fast fading occurs. However, once you have a station tuned in, reception will usually be more comfortable if you switch to the “**SLOW**” position (keeping the receiver from picking up low-level noise during pauses in speech).

For CW reception, if several signals are present in the passband, the “**FAST**” position will allow the quick gain recovery essential to restore solid copy.

For AM reception, the “**SLOW**” position is usually better, and for **300-baud packet** and **RTTY/AMTOR**, the “**FAST**” or “**OFF**” positions will usually give the fewest errors/retries.

RF GAIN SETTING

When tuned to a moderate strength signal, if low level background noise is still present after setting the **ATT** selector, try reducing the **RF GAIN** control from the fully clockwise position. This reduces the signal input to the first mixer via a PIN diode attenuator and causes the minimum S-meter reading to move up the scale, often clearing up the background noise and putting the desired signal more “in the clear.” Remember, however, to return this control fully clockwise when you want to receive weak signals, or read low levels on the S-meter. Also read the box on this page.

Note on AGC

The AGC “**OFF**” position disables the overload-protection normally provided by the AGC circuitry. If the **RF GAIN** control is left fully clockwise in this condition, the RF and IF amplifiers can be easily overloaded (causing distortion) when a strong signal is received. Correct the overload either by setting the **AGC** selector to another position, or by turning the **RF GAIN** control counterclockwise to set receiver gain to a comfortable level.

DEALING WITH INTERFERENCE

NOISE BLANKER

Press the **[NB]** button to activate the IF Noise Blanker.



The two noise blanker circuits in the **MARK-V FT-1000MP Field** are provided for two different types of pulse noise; (A) a narrow-pulse blanker for short pulse noise such as from switching transients, automobile ignitions, and power lines, and (B) a wide pulse blanker for longer duration man-made pulse noise. This noise blanker can sometimes also reduce the level of static crashes from electrical storms. You can select the desired noise blanker circuit (“narrow” or “wide”) and its blanking level via *menu selection 2-8*.

Operating tip: Holding in the **[FAST]** key, and pressing the **[NB]** button, yields a “short-cut” to *menu selection 2-8*.

In urban environments, there may be several or even dozens of local noise sources; these may combine in such a way as to make detection of a clear “impulse” impossible. The IF noise blanker may, however, reduce the noise level significantly, allowing the EDSP Noise Reduction feature to reduce the noise even further.

If the blanker seems to distort a signal you’re listening to, reduce the setting for optimum readability, or turn it off. During periods of extreme signal density (such as a contest), the noise blanker is best left off.

IF FILTER (BANDWIDTH) SELECTION

There are two banks of selectable filters, one each for both the 8.215 MHz 2nd IF and 455 kHz 3rd IF in the Main Receiver. Filter



selections can be cascaded for versatility in combating QRM and tailoring received audio. From the factory, 2nd IF 500 Hz and 2.4 kHz filters and 3rd IF 2.4 kHz filter are provided. Other filters can be ordered from your Yaesu dealer. Installation instructions are covered on page 113 and filter *menu selections (5-0 through 5-7)* on pages 101 and 102. The illustration at the bot-

tom of the page provides a representation of filter selection in the **MARK-V FT-1000MP Field**.

Select the desired bandwidth by pressing one of the **[BANDWIDTH]** buttons. The LEDs inside each button glow red while selected.

In the AM mode, the **[NOR]** (6-kHz) AM-wide bandwidth is typically selected for both the 2nd & 3rd IF (labeled THRU on the bottom of the 2nd IF column). This gives the highest fidelity, and is best on strong AM signals (and particularly music). The effects of the **SHIFT** and **WIDTH** controls in this wide bandwidth are subtle, but they can be helpful in fine tuning the audio characteristics. For weaker AM signals, or where adjacent channel interference is present, the **[NAR 1]** (2.4 kHz bandwidth) offers a compromise between interference rejection and fidelity. In this case, the **SHIFT** and **WIDTH** controls can be used quite effectively to improve fidelity (see the illustrations).

However, even better reception of AM signals under difficult conditions can usually be had by switching to an SSB mode (whichever gives the clearest reception), and superb reception of weak signals is often possible using diversity reception, described on page 46.

In SSB modes, the **[NAR 2]** (2.0 kHz bandwidth) button can sharply cut interference from unwanted signals on either side of the desired signal (although with some necessary loss of fidelity). In CW, the **[NOR]** (2.0 kHz or 2.4 kHz bandwidth) is often convenient to give “a wide view” of the band when tuning around, but once a signal of interest has been found and centered in the passband, the **[NAR 1]** (500 Hz bandwidth) or **[NAR 2]** (250 Hz bandwidth) selections are much better.

In addition to selecting various filter combinations, you have several features that can be used singly, or in combination to eliminate or reduce the interference to an acceptable level. Although their use requires little more than rotating a control, it is good to have knowledge on how each function works and the effect on the QRM encountered.

Main receiver (VFO-A) IF Bandwidth Filter Selection

MODE	NOR		NAR 1		NAR 2	
	2nd IF (8.2MHz)	3rd IF (455 kHz)	2nd IF (8.2MHz)	3rd IF (455 kHz)	2nd IF (8.2MHz)	3rd IF (455 kHz)
SSB	2.4 kHz/ATT*1	2.4/6.0 kHz*1	2.0 (2.4) kHz	2.0 (2.4) kHz	N/A (2.0 kHz)	N/A (2.0 kHz)
CW	2.0/2.4 kHz*2	2.0/2.4 kHz*2	500 Hz	500 Hz	250 Hz	250 Hz
AM	ATT	6.0 kHz	2.4 kHz	2.4 kHz	2.0 kHz	2.0 kHz
RTTY/PKT/USER	2.4 kHz	2.4 kHz	2.0 kHz	2.0 kHz	250/500 Hz*3	250/500 Hz*3

*1: You can select the bandwidth via *menu selections 5-0*. The forward value (bandwidth) is factory default.

*2: You can select the bandwidth via *menu selections 5-2*. The forward value (bandwidth) is factory default.

*3: You can select the bandwidth via *menu selections 5-4*. The forward value (bandwidth) is factory default.

DEALING WITH INTERFERENCE

WIDTH CONTROL

We just saw that specific IF filters can be selected to limit the receive bandpass to a pre-set width (essentially the total width of the installed filter). In a crowded band, you ideally want to narrow the bandwidth just to the point where the unwanted signal is attenuated while still retaining enough bandpass to recover the desired station. In real-life band conditions, however, this ideal bandwidth is often somewhere “in-between” the several selectable filter bandwidths.

The **WIDTH** control can be used in all modes except FM to continuously narrow or broaden the bandpass skirt (within the limit of the selected filter) for the best skirt shaping and optimum cutoff and interference rejection during each QRM situation. Unlike older types of width controls that adjust both sides of the filter slope at the same time, the **MARK-V FT-1000MP Field's WIDTH** control narrows the passband from either the upper or lower side (see illustration below). Thus, you only narrow the side of the bandpass where the QRM is located.

The center detent on the outer **WIDTH** control provides maximum bandwidth, which is equal to the selectivity of the filter used with the operating mode. Clock-

wise rotation moves the upper skirt of the IF passband lower in frequency, and counter-clockwise rotation moves the lower skirt upwards. If a QRM condition occurs after tuning in a station, slowly rotate the control in the direction where the interference is reduced while the station is still workable. As you rotate the control you will hear the audio response change as the passband is narrowed. If the QRM is very close, the amount of bandwidth reduction necessary to cut the QRM may leave the desired station's audio unrecoverable, or it may not be possible to entirely eliminate the QRM.

When the QRM is all above or all below the desired signal it is usually only necessary to rotate the **WIDTH** control either to the left or right to cut the interference from the receiver passband. The **SHIFT** control (covered next) will also work for this, but may introduce interference from the other side of the signal.

When you have activated the **IDBT** feature by pressing the **[IDBT]** button on the **Shuttle Jog**, the EDSP (Contour) filter's passband width reduces according to the **WIDTH** knob setting. That is, the IF bandwidth and the EDSP bandwidth will be matched, according to the setting of the **WIDTH** control knob's position. The IDBT feature is available in the USB and LSB modes.

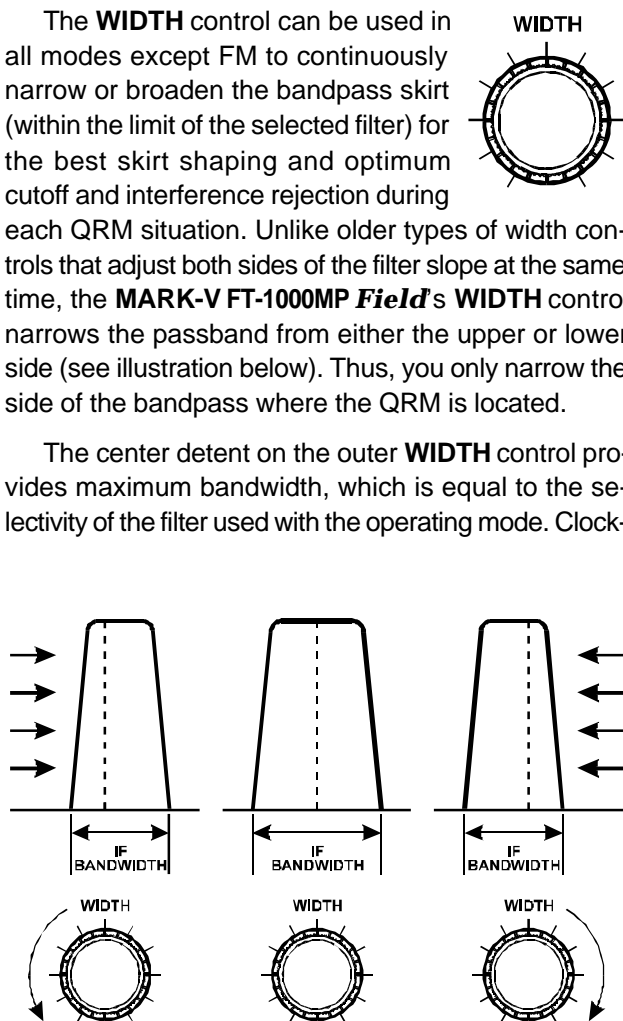

WIDTH Action

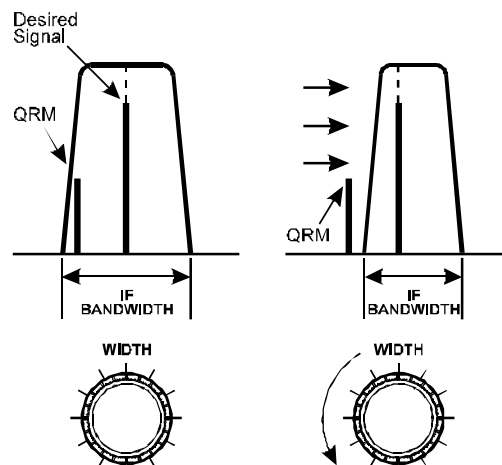

Using WIDTH control to reduce QRM

DEALING WITH INTERFERENCE

SHIFT CONTROL

The **SHIFT** control tunes the relative position of the receiver IF passband with respect to the displayed frequency in all modes except FM. The control is detented in the center position, which represents the passband center frequency, which is also the displayed frequency. Turning the control clockwise raises the passband center frequency, while turning the knob counter-clockwise lowers it.

When QRM is present on both sides of the tuned station, first adjust the **SHIFT** control just to the point where the interference from one side is eliminated, and then rotate the **WIDTH** control in the opposite direction to eliminate interference from the other side. The optimum settings of these controls depend on the relative signal strengths of the desired station and the QRM, and requires practice.

When you have activated the **IDBT** feature by pressing the [IDBT] button on the **Shuttle Jog**, the EDSP (Contour) filter's passband offset changes according to the **SHIFT** knob setting.

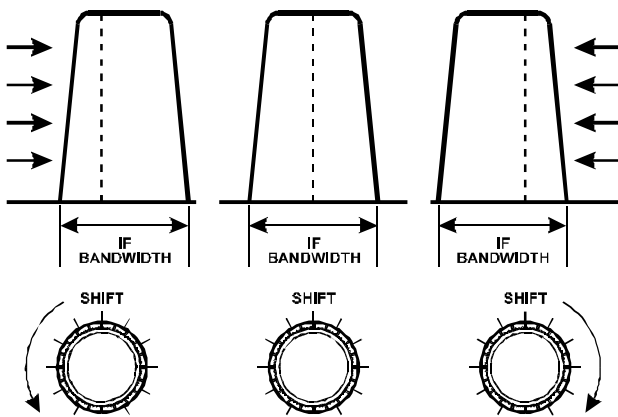

IF SHIFT Action

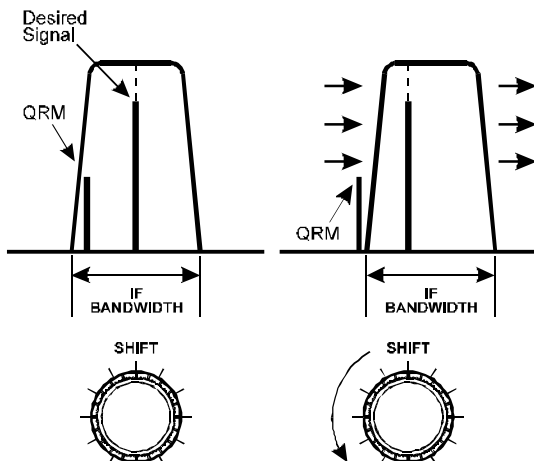

Using IF SHIFT to reduce QRM

NOTCH FILTER

After tuning in a desired signal and adjusting the IF bandwidth and shift, if "heterodyne" interference such as from a carrier or CW signal occurs, activate the IF notch filter by pressing the **NOTCH** button and slowly adjusting the **NOTCH** control to null the offending carrier. Note that if the interfering carrier is more than about ± 1.2 kHz away from the center of the passband, the notch filter may be unable to null it. In this case, switch the notch filter off, and readjust the IF bandwidth and shift so that the undesired carrier is outside of the passband.

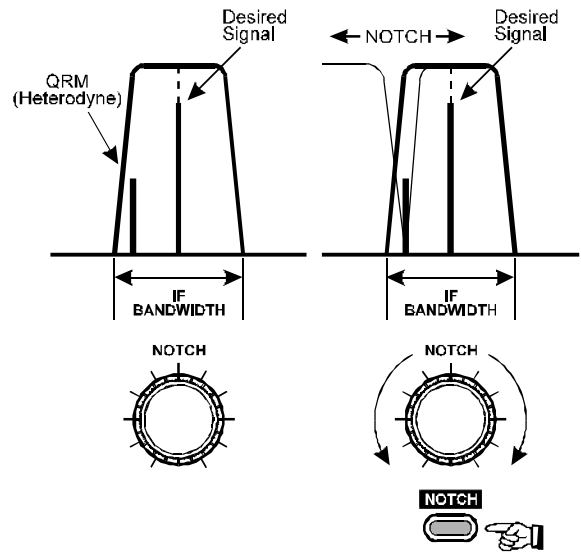

The **NOTCH** feature actually has three operating modes, involving different combinations of the IF Notch filter and/or the EDSP Notch filter. You may use *menu selection 2-9* to utilize only the IF Notch (**IF NOTCH** selection), the EDSP Notch (**Auto DSP** selection), or both Notch filters (**SELECT**). With **Select** engaged, any residual interference getting past the IF Notch will be eliminated by the EDSP Auto-Notch, and this combination of filters provides impressive results!

If the **SELECT** option is chosen, you may need to watch the S-meter to obtain optimum performance. The EDSP Auto-Notch will remove the audio from the offending carrier, but in doing so it will also eliminate your ability to adjust the IF Notch "by ear." Watch the S-meter while adjusting the **NOTCH** control to null out the interfering signal.

SHIFT/WIDTH Tuning Steps

Rotating the **SHIFT** or **WIDTH** control tunes the IF passband using default 10-Hz steps. If desired, you can change to 20-Hz steps, which offers a faster response when turning the control knob. See *menu selection 1-2* to set the default steps as desired.

DEALING WITH INTERFERENCE

CLARIFIER (RX/TX OFFSET TUNING)

The three **CLAR** buttons near the lower right corner of the front panel, and the control just above them, are used to offset either the receive, transmit, or both frequencies from their settings on the main display. The three small numbers in the center of the display (just to the right of the main frequency display) show the current Clarifier offset. The Clarifier controls on the **MARK-V FT-1000MP Field** are designed to allow you to preset an offset (up to ± 9.99 kHz) without actually retuning, and then to activate it with the Clarifier's **RX** and **TX** buttons.

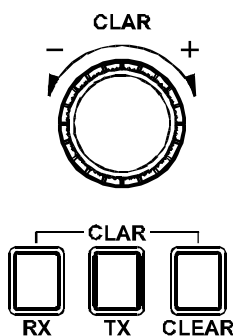

Perform the following steps, if you like, to familiarize yourself with the Clarifier controls:

- Without pressing any of the Clarifier buttons, rotate the **CLAR** knob back and forth while watching the small center display. Notice that the small digits change, indicating the preset Clarifier offset (which hasn't been *applied* to the Tx or Rx frequency yet) while the main display remains unchanged.
- If you press the Clarifier **TX** button, "**CLAR**"-"**TX**" appears below the smaller offset display, and if you press the **PTT** you will see the Tx frequency shift by the amount of Clarifier offset.
- If you press **RX** instead, notice that "**RX**"-"**CLAR**" appears and the frequency offset is applied and the display shifts to the offset receive frequency accordingly. Press the **PTT** switch, and notice that the

transmit frequency remains the same as the original frequency display when the receive Clarifier is off. You can reset the offset to 0.00 kHz at any time by simply pressing **CLEAR**.

- With the RX Clarifier active, the center tuning marker just above the main frequency display moves to the right or left as you change the offset by rotating the **CLAR** knob. Also notice that the main frequency and the Clarifier offset displays change together.
- Now press the Clarifier **CLEAR** key and observe that the offset is cleared to zero, and the Main VFO frequency returns to what it was originally.

The Clarifier is commonly used when you are in contact with a station whose transmitter drifts (or perhaps you didn't have him quite tuned in when you called him). You don't want to change your transmitting frequency, as that would force him to retune - you just want to adjust your receiver.

Another application for the Clarifier is in a casual DX pile-up situation, where the DX station is listening in a "Split" mode (but listening "UP 5" or a similar split of less than 10 kHz). In this case, you leave the main receiver on the DX station's frequency, then use the RX Clarifier to tune the pile-up area, listening for the station currently in QSO with the DX station. When you find that station, you can switch the TX Clarifier On and the RX Clarifier Off; you will now be receiving back on the DX station's frequency, but you will be transmitting on the frequency where the DX station probably is still listening. See the discussion on page 56 regarding the use of the **SPOT** control for CW spotting; it speeds up the above process significantly.

Advice on QRM Reduction

Use the **BANDWIDTH** buttons and then the **SHIFT** and **WIDTH** controls to suppress interference. Their use varies somewhat from mode to mode.

When you are ready to retune to a new frequency, you may wish to return the **SHIFT** and **WIDTH** controls to their default positions (center detent). The **WIDTH** control can also be turned counter-clockwise to reduce the IF bandwidth more gradually, and then the **SHIFT** control can be turned left or right from center to shift the center frequency lower or higher, as depicted in the drawing.

For digital modes, the wider bandwidth selections are fine for tuning around, but the 500 or 250 (Hz) bandwidths will generally give the best copy with narrow shifts. If you have the RTTY and PKT menu selections set to match your TNC/terminal unit (see page 55), you should not need to adjust the **SHIFT**

control at all, and the **WIDTH** control should only be adjusted with a great deal of care (to avoid losing the contact). See the section on digital modes in this manual for more details.

For 300-baud packet, use the 500 (Hz) bandwidth and keep the **WIDTH** control centered; the **SHIFT** control may require fine tuning either side of center for optimum copy of weak signals. Experiment with the **SHIFT** setting on a busy packet channel, and then note the optimum setting for all future HF packet operation (it will be the same unless you replace your TNC or recalibrate the input tones).

Note - except during extreme QRM conditions, the **WIDTH** and **SHIFT** controls should be left in their center (detent) positions when tuning the receiver to a new frequency. This will provide the best fidelity and easiest tuning.

DEALING WITH INTERFERENCE

When you finish your QSO, remember to press the Clarifier RX button again to turn off the Clarifier. You might also want to clear the offset when done.

The **MARK-V FT-1000MP Field** has an independent Clarifier for each VFO, on every band, plus one on each of the 99 memories. This means that Clarifier TX/RX and offset settings are not (improperly) carried over when you change bands or memory channels, but rather are stored *in the same condition you last set them* until you return to that VFO, band, sub receiver, or memory again.

Clarifier Settings

There are several settings that affect Clarifier operation and the way the frequency is displayed that you should be familiar with. After understanding their relationships, you can set them as desired.

Tuning Steps - The default 10-Hz tuning steps for the Clarifier can be changed similar to the VFO's using *menu function 1-9*. Choose between 0.625 Hz, 1.25 Hz, 2.5 Hz, 5 Hz, 10 Hz or 20 Hz Clarifier steps.

Clarifier M-Tune - Programmed memories can be re-tuned using the Clarifier when this is enabled (*menu function 1-8*). We will discuss memory tuning in detail later on.

OFFSET DISPLAY MODE

The small sub-panel to the right of the MAIN VFO-A display can be configured to show one of four different operating parameters.

By default the Tx or Rx Clarifier offset appears. However, this can be changed to the channel frequency, split offset (difference between VFO-A and VFO-B), or else the CW Pitch setting. Which display you choose, of course, depends on your operating habits, but can be easily changed using *menu function 3-5*. The following is a brief description of each display mode.

Clarifier Offset - this 3-digit display shows the Clarifier Tx or RX offset (± 9.99 kHz) to be applied to the operating frequency.



Channel Frequency - this displays the frequency stored in the memory channel displayed to the right. If the memory has not yet been stored with data, the display remains blank (except for a lone decimal point).



Offset - displays the absolute (+/-) frequency difference between MAIN VFO-A and SUB VFO-B. For operators chasing DX stations working split, this makes tuning "down" easier (no mental subtraction from your operating frequency is needed).



CW Pitch - this displays the CW BFO pitch as adjusted by the PITCH control at the lower right corner of the front panel.



TRANSMITTING

The transmitter can be activated within the 500-kHz segment of any of the HF amateur bands, and from 28 to 30 MHz. When tuned to any other frequency, “GEN” is displayed at the left side of the display, and the transmitter is disabled. However, you are responsible to restrict your transmissions to those frequencies on which you are authorized to operate, per the terms of your amateur license. You should also restrict transmissions to the frequencies for which your antenna is designed.

Band	TX Range
160 Meters	1.50000 ~ 1.99999 MHz
80 Meters	3.50000 ~ 3.99999 MHz
40 Meters	7.00000 ~ 7.49999 MHz
30 Meters	10.00000 ~ 10.49999 MHz
20 Meters	14.00000 ~ 14.49999 MHz
17 Meters	18.00000 ~ 18.49999 MHz
15 Meters	21.00000 ~ 21.49999 MHz
12 Meters	24.50000 ~ 24.99999 MHz
10 Meters	28.00000 ~ 29.99999 MHz

Attempting to transmit outside of an amateur band segment will cause the red “TRANSMIT” indicator to the right of the meter to blink. The transmitter is also temporarily inhibited when stopping memory scanning (described later), as pressing the PTT switch while scanning just causes the scanner to stop.

Whenever the transmitter is activated, the **MARK-V FT-1000MP Field** automatically detects any reflected power that might appear at the main antenna jack (as a result of an impedance mismatch), and disables the transmitter if too much reflected power is found (in which case the red “HI SWR” indicator at the right side of the display will be lit). Although this protection system should prevent any damage to the transceiver, we still recommend that you never activate the transmitter without having a proper antenna connected to the main **ANT** jack.

SELECTING ANTENNAS

You can select between two rear-panel antenna connectors for transceive operation via the front panel, perhaps eliminating the need to utilize an external coaxial switch.

Press the **A/B** button to select the rear-panel jack you wish to use. The antenna connected to this jack is used for receive (and always for transmit). If a separate receive-only antenna is connected to the “RCA” jack labeled **RX IN**, and the front panel’s **RX** switch is pressed, the antenna connected to the **RX IN** jack will be used by the receiver. A relay engages during transmit, and the last-selected antenna (**A** or **B**) will be used for transmit. Refer to the diagram at the top of the next column.

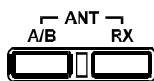

Antenna Selection

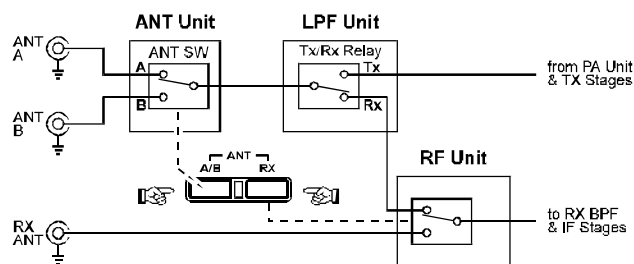

Antenna selections are automatically copied along with other operating parameters during memory programming (covered later), and will take effect when memories are recalled later. However, if you do not want this data stored, you can select regular operation, or else disable **ANT** switch operation. When disabled, antenna selection remains fixed on jack **A**. Recall *menu selection 8-5* to configure the **ANT** switch function as desired.

AUTOMATIC ANTENNA MATCHING

The built-in automatic antenna tuner unit is capable of matching antenna with impedances from 20~150 Ohms, which corresponds to a maximum SWR of approximately 3.0:1. If the antenna you are using exceeds this SWR as configured, it must be adjusted (mechanically or electrically) until a feedpoint impedance closer to 50 Ohms can be obtained.

The **MARK-V FT-1000MP Field** provides 39 tuner memories, which store the exact positions of the tuning capacitors and corresponding inductance values, for outstanding operating convenience.

When you use the tuner the first time on an antenna, set the **RF PWR** control to around the 9 o'clock position, to minimize interference you might cause others, and also to minimize stress on the tuner, feedline, and antenna (in case there is a high SWR). Ensure beforehand that the frequency you will transmit on is clear of other signals. Also, if you want to monitor the tuner’s action visually, set the meter **IC/SWR** selector to display “**SWR**.”

When the channel is clear, press the **TUNER** button momentarily. The “**TUNER**” indicator comes on, indicating the ATU is activated, and the “**WAIT**” indicator next to it appears while the tuner seeks the proper matching settings (and, if monitoring SWR on the meter, you should see the tuner select the lowest possible reading). When the “**WAIT**” indicator turns off, you are ready to transmit (so long as the “**HI SWR**” indicator didn’t light).

Pressing and holding in the **[TUNER]** button is the action which causes ATU settings to be stored into memory.

TRANSMITTING

If the SWR presented to the transceiver is above 3:1, the tuner will generally not complete the tuning process (although in certain borderline cases, it may actually be able to lower the SWR below 1.5:1). If the pre-tuning SWR is above 3:1, the auto-tuner will *not* store the tuning settings, under the presumption that corrective antenna work is required.

After using the antenna tuner, the “**TUNER**” indicator will remain on (unless you press the [**TUNER**] button to turn it off), and the “**WAIT**” indicator will flicker momentarily when you change frequency, indicating that the main microprocessor is reporting the frequency change to the tuner coprocessor (reception is unaffected). If you have tuned far enough to possibly require rematching, it will reset itself to the new range (if it has any previously stored settings for the new range). However, when you first connect a new antenna, the tuner will not have the correct settings stored in these memories, so you will need to “train” the tuner, by pressing and holding the [**TUNER**] button for ½ second whenever you change to a new band or frequency range (for this antenna).

If you want to use an external antenna tuner, the internal ATU should be disabled. *Menu selection 8-8* provides a more “fail-safe” method of doing this (as opposed to simply turning the [**TUNER**] switch off).

Note: The “G5RV” multiband antenna does not present an SWR below 3:1 on *all* HF amateur bands, despite its reputation as an “all-band” antenna. You will need to perform additional impedance matching with respect to the basic G5RV design, especially on 30, 17, and 12 meters.

Important Note

Although the antenna tuning process normally is very fast, certain difficult impedances may require as long as 50 seconds to match. This is a normal condition, however, related to the time required for the variable capacitors to make a complete search for the optimum setting with the available values of inductance.

SSB TRANSMISSION

To transmit in LSB or USB mode:

- Make sure the appropriate mode indicator is lit, and set the meter **ALC/COMP** selector to view “**ALC.**”
- If this is the first time you are transmitting SSB with the **MARK-V FT-1000MP Field**, preset the **MIC** and **RF PWR** controls to about the 12 o'clock position, and make sure the **VOX** is off (button out).
- Check the “**RX**” and “**TX**” LEDs above the tuning knobs to determine which frequency you're going to transmit on, and make sure “**GEN**” is not showing to the left of the main frequency display.
- To transmit, just press the **PTT** (push-to-talk) switch on your microphone, and talk.

To determine the optimum setting of the **MIC** control for your microphone, adjust it while speaking into the microphone (at a normal level) so that the meter deflects to about midrange on voice peaks (the upper end of the red ALC range). Once found, this setting can be left as-is unless you change microphones. The proper adjustment point for most commonly-available amateur microphones is a setting between about 9 o'clock and 10 o'clock.

You can adjust the **RF PWR** control for more or less output, from about 5 to 100 watts (on the upper PO meter scale), as desired. However, you should always use the lowest possible power output to maintain reliable communications - not only as a courtesy to other stations, but to minimize the possibility of causing overload to nearby home-entertainment devices, and to reduce heat generation and maximize the life of the equipment.

Transmitter Monitor

The transmitter monitor is actually a separate receiver circuit which picks up a sample of your transmitted RF signal, allowing you to hear accurately how the signal sounds. This feature is very helpful for setting up the speech processor controls, among other things.

Activate the monitor by pressing the orange [**MONI**] button (below the **AF GAIN** control) so that its red LED lights, and adjust the **MONI** control beneath the meter for a comfortable volume while transmitting. Audio feedback of your signal from the loudspeaker to the microphone may occur if the **MONI** control is not properly set, you may want to use the monitor with headphones; if so you should plug them in now.



TRANSMITTING

Microphone Tone Selection

Before setting up the speech processor, set the selector switch on the rear of the **MH-31 B&D** microphone (supplied) for the desired tone characteristic. The “2” setting suppresses low frequencies, providing more “pile-up punch” for DX operating. The “1” setting increases the bass response, important for maximum intelligibility when speaking in a language rich in vowel sounds (such as Japanese).

RF Speech Processor

Once the proper MIC control setting has been determined, you can activate the RF speech processor to increase the average power of your transmitted signal.

- ❑ First set the **METER** selector to the “**ALC**” (Automatic Level Control) position, and ensure the level is within the red zone while speaking into the microphone.
- ❑ Next set the **METER** selector to the **PROC** “**COMP**”(speech processor compression) position, and press the [**PROC**] button (at the left end of the row of buttons along the bottom) so that its red LED lights.
- ❑ Now while speaking into the microphone, adjust the **PROC** control for a compression level of 5 to 10 dB on the COMP scale of the meter (the second scale from the bottom). If you have the monitor activated, you will be able to hear the effect of the compression on your signal. In any case, we do not recommend higher compression settings, as your signal will actually become *less* readable. For the purposes of making accurate adjustments, the long utterance of the word “Four” usually provides a stable, full voice waveform, ideal for setup of the RF speech processor.
- ❑ Finally, move the **METER** selector back to the “**PO**” position, and (without touching the **MIC** control setting) adjust the **RF PWR** control for the desired power output on voice peaks.

MIC → PROC

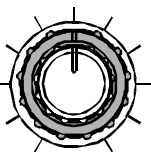

To enable this feature, press the orange [**CLASS-A**] switch (located below and to the left of the Main Tuning dial) while operating either in USB or LSB. During Class-A operation, the PO meter will indicate up to 25 Watts of power output, while the IC meter will show a non-modulation (constant) current of approximately 10 Amps.



Although the full advantage of Class-A operation will be compromised somewhat when a (non-Class-A) linear amplifier is used, the very clean drive power from the **MARK-V FT-1000MP Field** will, nonetheless, provide a significant improvement in overall signal quality.

Carrier Point Offset

This feature allows shifting the carrier point IF passband (and hence the RF passband as well) of your transmitted signal in the SSB mode, to customize your signal for your own voice characteristics.

Seven individual carrier settings can be user-adjusted:

USB Carrier (Tx & Rx) - adjustable from -200 ~ +500 Hz.

LSB Carrier (Tx & Rx) - adjustable from -200 ~ +500 Hz.

Processor Carrier (USB & LSB) - adjustable from -200 ~ +500 Hz.

AM Carrier - adjustable ± 3000 Hz.

To display and adjust the various carrier settings, see *menu selection 8-9*. With the offset displayed, you can adjust it throughout the ranges shown above. A minus sign indicates the offset is closer to the carrier (low-frequency speech emphasized). You can transmit during carrier display and adjustment.

Of course, you can adjust the offset by trial-and-error on the air, but it is better to use the built-in monitor circuit or a monitor receiver, in which you can hear the effect yourself. Otherwise, we recommend starting with +0.10 (+100 Hz) offset initially, to add some “crispness” to your processed speech.

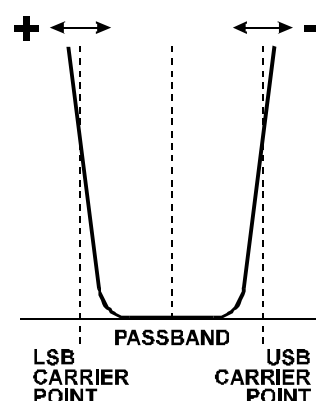

Class-A Operation

A unique feature of the **MARK-V FT-1000MP Field** is the capability to operate SSB in Class A. Switching to Class A yields an ultra-linear transmitted signal, with intermodulation distortion products *significantly* better than possible with a typical Class AB₂ transmitter design.

Because Class A involves a total current dissipation much greater than utilized for Class AB, to which you’re probably accustomed, maximum power output during Class A is limited to 25 Watts as indicated on the PO meter.

TRANSMITTING

VOX Operation

(Voice-Actuated T/R Switching Operation)

VOX operation allows you to activate the transmitter in any voice mode merely by speaking into the microphone, without having to press the **PTT** switch.

For the VOX circuit to operate properly, three controls in the top access panel must be set to match your microphone and the acoustic environment of your station. Once set, these controls should not require readjustment unless you change your microphone or station location.

- ❑ First make sure the receiver is set for normal volume on a clear channel, and preset the **VOX** (gain) control in the top access panel fully counterclockwise. Also preset the **A-VOX** (Anti-VOX) and **DLAY** (VOX Delay) controls in the top access panel to their 12 o'clock positions.
- ❑ Set the **RF PWR** control fully CCW (to avoid creating interference while you set up the VOX controls). Now press the **[VOX]** switch near the upper left corner of the front panel.
- ❑ Without pressing the **PTT** switch, speak continuously into the microphone while slowly adjusting the **VOX** control (in the top access panel), looking for the point where your voice just activates the transmitter. Advancing the **VOX** Gain control beyond this point will make the VOX excessively sensitive to random background noise in your operating room.
- ❑ Now speak intermittently into the microphone, and note the "hang time" between the moment you stop speaking and when the receiver is reactivated. This period should be just long enough so that the transmitter remains keyed between words, but drops back to receive during pauses. Adjust the **DLAY** control, if necessary, for a comfortable hang time.

The **A-VOX** control probably needs no adjustment, but if you find that, with the microphone in its normal operating position, receiver audio from the loudspeaker trips the transmitter, advance the **A-VOX** control more clockwise. On the other hand, if transmitter keying with the VOX keying seems sluggish or unstable when you speak into the microphone, try a more counter-clockwise setting.

CW TRANSMISSION

There are several types of CW transmission available with the **MARK-V FT-1000MP Field**. All require that you have a CW key or keyer paddles connected to either of the **KEY** jacks on the front or rear panel (with a 3-contact plug). You simply use the **RF PWR** control to set your output power.

Straight-Key Operation

This section describes basic CW operation using a traditional "straight key;" however, this section also applies when keying the **MARK-V FT-1000MP Field** with the output from an external keyer, or when sending CW generated via a computer's COM or LPT port.

- ❑ First preset the **RF PWR** control to about 12 o'clock. Select the CW mode, if you haven't already, and for now, make sure the **[KEYER]** and **[BK-IN]** switches near the lower right corner of the front panel are both off.

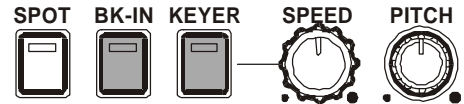

- ❑ Press the **[VOX]** button to turn on the VOX circuit, which provides automatic transmitter activation when you close your key. If you want to practice CW with the sidetone, you can leave the VOX off.
- ❑ To transmit, simply close your key and advance the **RF PWR** control for the desired power output level.
- ❑ You can adjust the CW sidetone volume, if necessary, for a comfortable level using the trimmer accessible via the hole on the rear panel (see item #3 on page 34).
- ❑ Release the key to return to receive.

You are now using semi break-in CW, in which the transmitter remains activated except during pauses in your sending. You can set the delay during which the transmitter remains on after you stop sending, by adjusting the keyer delay setting (*menu selection 7-5*).

However, if you prefer full break-in (QSK) operation, in which the receiver is activated between each dot and dash, simply press the **[BK-IN]** switch (the **[VOX]** switch should not be depressed).

TRANSMITTING

Electronic Keyer Operation

The built-in electronic keyer offers two iambic modes and a mechanical “bug” keyer emulation. You will need to connect keyer paddles to one of the **KEY** jacks to use the keyer.

The keyer is set at the factory for iambic keying, in which one keyer paddle produces dots, and the other dashes. Squeezing both produces alternating dits and dahs. *Menu selection 7-0* allows choosing three keyer modes:

Iambic 1 - Iambic keyer with ACS (Auto-Character Spacing) disabled. Weighting is user-selectable via *menu selections 7-1 & 7-2*.

Iambic 2 - Iambic keyer with ACS enabled. Weighting is set via *menu selections 7-1 & 7-2*.

BUG - Emulates mechanical “bug” keyer (one paddle produces dits and the other is used to produce dahs manually (like a straight key)).

Once the transceiver has been set up for CW transmission as just described, you can activate the keyer with the **[KEYER]** pushbutton near the lower right corner of the front panel (its red LED should light). Now squeeze the paddles, and adjust the **SPEED** control for the desired sending speed (if you are using the bug simulator mode, don't squeeze both paddles; just press the “dot” paddle).



If the dot:space and/or dash:space weighting are not to your preference, see *menu selections 7-1* and *7-2* to configure your keyer's settings.

You can use the keyer for both semi and full break-in keying, as described in the previous section.

ACS (Auto Character Spacing)

This feature improves your CW sending quality by ensuring the inter-character spacing of dots and dashes remains constant. Although dot/dash weighting is automatically maintained at the desired ratio, the inter-character spacing can sometimes vary from operator to operator, and proportional spacing is sometimes not maintained. This does not present much of a problem during slow CW sending, but at higher speeds, the effect is more pronounced and sometimes makes copy difficult.

ACS works on the principle that the spacing between characters should be 3x the duration of the “dot.” If you utilize the standard 3:1 dash:dot ratio, this also happens to be the same duration of a “dash.” Maintaining this inter-character spacing is what prevents the sent characters “E” and “T,” for example, from merging into what sounds like the character “A” (see illustration).

ACS is activated when keyer mode “Iambic 2” is selected from *menu function 7-0*. For memory keyer programming using the optional **FH-1** Keypad, you should always use keyer mode Iambic 2 during message programming, although you can switch back to Iambic 1 after the messages are loaded, if Iambic 1 is more comfortable for you.

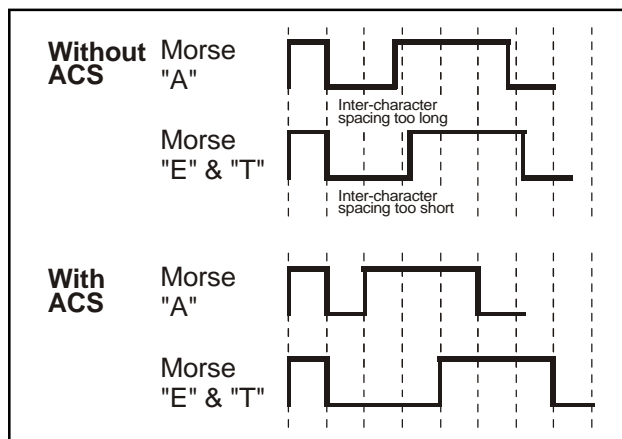

CW Straight Key and Paddle Connections

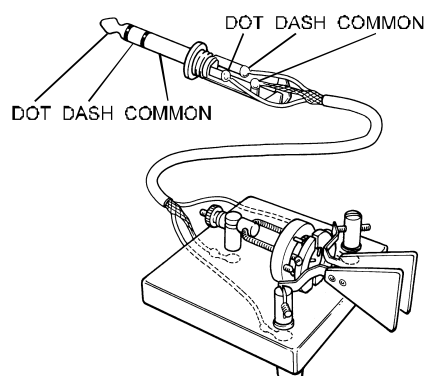
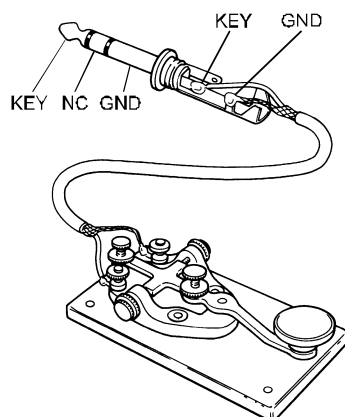

TRANSMITTING

Keyer Settings

Keyer Dot & Dash Weighting - *menu selections 7-1* and *7-2* adjust the Dot:Space and Dash:Space weighting. Default values are “10” (1:1) for Dot:Space, and “30” (3:1) for Dash:Space.

Keyer Delay - For “semi-break-in” (non-QSK) CW operation, the switchover time delay from Tx to Rx can be adjusted from 0 seconds (full break-in) to 5.10 seconds (in 10-msec) using *menu selection 7-5*. Note that this provides a *separate* “hang time” adjustment from the “VOX Delay” setting used during voice operation.

CW Break-In - The switching time of the CW carrier waveform can be adjusted from 0 to 30 milliseconds for use with linear amplifiers with T/R switching circuits not designed for full-QSK operation. This feature provides a programmable delay in the total CW envelope character string, not a simple truncation of the first character. *Menu selection 7-4* controls the time delay. See also “**Linear Amplifier Operation**” on page 12 for more details.

CW Pitch Setting and Spot Tone

In the CW mode (only), pressing the [SPOT] switch on the lower edge of the front panel activates the CW sidetone, which is also used as a spotting oscillator. The frequency of this tone is also (exactly) the frequency at which your transmitted signal will appear relative to

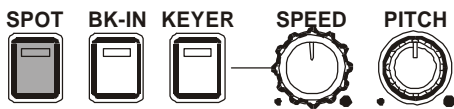

that of the incoming signal. Therefore, if you match the pitch of the SPOT oscillator's tone to the pitch of an incoming signal, you will be exactly “zero beat” with that station's CW signal. In a DX pile-up situation, you can match your

transceiver's SPOT tone with that of the station being worked by the DX station, so as to be “next in line” on the same frequency. This SPOT signal is centered in the receiver section's IF passband, as well, which ensures that you will not lose track of his signal when switching to a narrower filter. Of course, you must turn off the [SPOT] switch once frequency alignment has been completed.

The CW pitch can be set from 300 ~ 1050 Hz (in 50-Hz increments) to match your personal operating preference. The CW Pitch feature adjusts the amount of offset from “zero beat” of your CW carrier, as well as the corresponding pitch of the CW SPOT tone; it also adjusts the center frequency of the receiver's IF passband, so as to be aligned with the other offset parameters just mentioned. The CW Pitch may also be adjusted to match that used by popular TNC (Terminal Node Controller) units and other CW decoders. While adjusting the pitch, you can have the frequency shown in the Clarifier sub-display by enabling it via *menu selection 3-5*.

To adjust the CW pitch (and SPOT tone along with it), press the [SPOT] switch, then rotate the **PITCH** control to set the tone to the pitch you prefer, or that used by your TNC or CW decoder. If the sub display is enabled for indication of the CW pitch, you can view the pitch frequency as you adjust it. The SPOT tone volume can be adjusted using the **SIDETONE** potentiometer, accessible on the rear panel of the transceiver).

In addition to the spotting oscillator, the directional tuning meter provides a constant visual indication of any signal at the center of the IF passband (if not too weak). You can just tune so that the segment flashes in sync with the signal of interest when it is centered (see page 41).

TRANSMITTING

AM TRANSMISSION

Transmitter setup for the AM mode is essentially the same as for LSB or USB, except that you must avoid overmodulating, and limit carrier power to 25 watts. This carrier level ensures that sufficient power is available for the voice sideband envelopes.

- ❑ VOX can be used in the AM mode, but for now, make sure the **[VOX]** switch is off, so as not to confuse adjustments.
- ❑ With the AM mode selected, press the **METER [ALC/COMP]** button to view the ALC range.
- ❑ Press the **PTT** switch, and rotate the **RF PWR** control for the desired power output (remember to limit transmitter carrier power to 25 watts in the AM mode).
- ❑ If you have already set the **MIC** control as described for SSB transmission, there should be no need to readjust it. If not, close the **PTT** switch, and adjust this control just to the point where the ALC begins to deflect slightly, and stays within the red ALC zone. Don't set it too far beyond this point, or your signal will become distorted from over-modulation.
- ❑ The transmit monitor is very helpful in setting the correct modulation level, and if you have headphones on, you should turn the monitor on now.

Note that the speech processor is disabled in the AM mode. You can, however, activate the VOX, if desired.

DIGITAL MODE OPERATION

Information regarding connection of your **MARK-V FT-1000MP Field** to commonly-available digital-mode modem devices is presented beginning on page 15.

Operating practices generally are governed by details provided in the operating manual for the TNC or modem you are using. However, a few guidelines are presented below, to help you get on the air quickly.

RTTY Operation

To operate, just press the RTTY mode button once or twice to select the desired sideband for operation. LSB is default, and is used by normal convention (USB can be selected for MARS or other applications). Should you need reverse tone polarity or non-standard shift (other than 170 Hz), configure *menu selection 6-1* and *6-2* as desired.

RTTY TONE/SHIFT INFORMATION				
Shift	High Tone Pair*		Low Tone Pair	
	Mark	Space	Mark	Space
170 Hz*	2125 Hz	2295 Hz	1275 Hz	1445 Hz
425 Hz	2125 Hz	2550 Hz	1275 Hz	1700 Hz
850 Hz	2125 Hz	2975 Hz	1275 Hz	2125 Hz
* indicates default setting (used by normal convention)				

For optimum signal-to-noise ratio, use the 250-Hz or 500-Hz BANDWIDTH selection for 170-Hz shift, the 500-Hz selection for 425-Hz shift, or the 2.0-kHz selection for 850-Hz shift. Remember that the Sub VFO receiver bandwidth is only selectable between 6.0 kHz, 2.4 kHz and 500 Hz (optional **YF-100** required) for RTTY (and PKT).

Note that for AMTOR operation, you must have the **VOX** button off, and may need to set the **AGC** control to "FAST" or "OFF" (and reduce the setting of the RF Gain control) for Mode A (ARQ).

300-Baud Packet

Construct a patch cable as required, and connect your TNC to the rear-panel **PACKET** jack. Do not connect the squelch line (pin 5) for 300-baud packet operation.

Tuning is very critical for F1 packet: you should tune the transmitter and receiver within 10 Hz of a signal to minimize repeats. The **MARK-V FT-1000MP Field** includes a few custom features to make packet operation more convenient.

Packet Tone Pair - This offsets the center of the IF bandpass according to the packet tone pair you are using. If set correctly, the receiver passband will remain centered on a properly-tuned packet station when switching between wide and narrow IF filters, minimiz-

TRANSMITTING

ing the need for re-tuning or use of the **SHIFT** control for re-centering.

One of four standard tone pairs can be chosen for operation from *menu selection 6-5*, as desired. The menu display shows the center frequency of the selected tone pair (see the table below for actual mark/space tone combinations). Set the Packet Tone Pair to match the tones generated by your TNC (these are usually set via terminal software or DIP switches - check in your TNC documentation).

Important Note! - if changing packet tone pair to other than 2025/2225 Hz, be sure to re-calibrate the tuning meter as outlined on page 85. The calibration routine is simple, and ensures your center tuning indication matches the tone pair.

Packet Frequency Display Offset - You can display the center frequency of the two transmitted carriers, (that is, the packet tone pair used), without any offset, instead of the actual carrier frequency. Recall *menu selection 6-4* and turn the main knob to select the offset (± 3.000 kHz).

Note - The default display offset is -2.125 kHz (to match the default tone pair* in 6-5 above, and assuming LSB operation). Ideally, the display offset should match the default tone pair, which in turn should match those used by your TNC. If you would rather have the actual carrier frequency (without offset) displayed, set the display offset to 0.000 kHz.

Packet Operation

Select the **NAR 2** (500-Hz or 250-Hz) filter for 300-baud packet, and press the **[PKT]** mode button on the front panel once or twice, so that the green LSB LED indicator lights along with the red PKT LED.

Transmitter adjustment is similar to SSB:

- Preset the **RF PWR** control counterclockwise, and set the **METER** selector to "**ALC**."
- Now set your TNC to its "calibrate" mode, preferably with both tones alternating, and adjust the **MIC** control so that the meter deflects to mid-scale. Your TNC's "TX Audio" output may also be capable of adjustment via a potentiometer inside the TNC.
- Switch the **METER** selector to "**PO**" and advance the **RF PWR** control for the desired power output.

PACKET TONE INFORMATION	
TNC Tone Pair	Tone Center Frequency
1070/1270 Hz	1170 Hz
1600/1800 Hz	1700 Hz
2025/2225 Hz*	2125 Hz*
2110/2310 Hz	2210 Hz
* indicates default setting (used by normal convention)	

When tuning, be aware that some common HF packet channels, such as "14.103" MHz, were originally determined to correspond with an actual IF center frequency 1700 Hz lower (in accordance with an old TAPR convention). Therefore, if you have the Packet Frequency Display Offset (*menu selection 6-4*) set to match your TNC's actual tones, the display shows 14.101.30 when tuned to the above frequency - which is the actual center of your receiver passband, and the frequency mid-way between the two FSK carriers you will transmit.

Initially, you may need to adjust the receiver IF shift slightly right or left to get the 500-Hz IF filters perfectly centered over incoming signals. Start with the **SHIFT** control centered, and try to establish a connection with a moderately strong signal on a clear channel. If the connection is poor (many repeats), move the **SHIFT** control slightly right, and see if the repeats decline. Continue in this manner until you find the best **SHIFT** setting (with minimal repeats), and use this same setting for all future HF packet operation.

1200-Baud FM Packet

The equipment setup for 1200-baud FM packet (above 29 MHz) is the same as for 300-baud packet, except that you may want to connect the squelch line of the TNC to pin 5 of the **PACKET** jack if you plan to use the squelch. Press the **[PKT]** mode switch until both it and the green LED on the FM mode button are lit. Tuning is much less critical in this mode, requiring no special adjustments. Also, the **FM MIC GAIN** control in the top access panel has been preset at the factory for proper deviation with typical signal levels, so you should not need to readjust it (you should adjust the Tx audio output level of your TNC, though, if your signal sounds distorted in the monitor).

To set up the transmitter for FM packet:

- Start with the **RF PWR** control counterclockwise.
- Switch the **METER** selector to "**PO**" and set the **RF PWR** control for the desired power output.

TRANSMITTING

FM TRANSMISSION

A separate, dedicated “29 MHz” band is provided on the **MARK-V FT-1000MP Field**, allowing you to operate both on 28 MHz in narrow-band modes, and above 29 MHz using narrow-band FM. This relieves you of the need to change all your configurations when switching voice modes.

For transmission, the only control on the front panel you need be concerned about is **RF PWR**. Microphone gain for FM is set via the separate **FM MIC** control in the top access panel, and normally needs no adjustment after leaving the factory. If you receive signals reports of low audio with a strong carrier, you may want to increase the gain. If you notice distortion in the transmit monitor, you may want to decrease it. Otherwise, we suggest leaving it alone. Remember that the apparent modulation level on 29 MHz will be less than you are accustomed to on VHF, due to international regulations restricting the maximum deviation to ± 2.5 kHz.

All you need to do for most operation is set the **METER** selector to the “**PO**” position, and adjust the **RF PWR** control for the desired output while transmitting. If you need full power, keep your transmissions to three minutes or less, with the same time for reception. Otherwise, set the power output to 50 Watts or less, and you should never encounter any duty cycle limitations.

You can use the VOX circuit for t/r switching, if desired, and the transmit monitor to listen to your signal. See also the FM Repeater Operation discussion in the next column.

FM Repeater Operation

Several features are available for operation on FM repeaters above 29 MHz, which typically use 100-kHz splits.

To locate these repeaters, you can ask around the calling channel (29.6 MHz), or you may want to load a block of memory channels (see page 67) with 50-kHz frequency multiples from 29.61 to 29.7 MHz (and FM mode, of course). Then set the squelch so that the receiver is silent on a clear channel, and hold the microphone **UP/DWN** keys to scan the memories.

Repeater Shift - When you find a repeater, press the [**RPT**] button, once for “-” shift (to transmit 100 kHz below your receiving frequency). Pressing it again will select “+” shift, but this is not used above 29.6 MHz. Press it once more to return to simplex. Try a quick identification transmission to make sure you have the shift right.

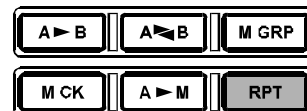

Repeater TX Offset - For repeaters not using the standard 100 kHz offset, you can change the default offset between 0 ~ 200 kHz via *menu selection 6-9*.

CTCSS Tone - A low-level 88.5-Hz subaudible tone is transmitted to access closed repeaters. Should a different CTCSS tone be required, you can choose any one of 33 standard tones via *menu selection 6-7*.

Tone Type – Continuous (CTCSS) or burst tone transmission is enabled from *menu selection 6-8*.

CTCSS TONE FREQUENCIES		
67.0 Hz	118.8 Hz	173.8 Hz
71.9 Hz	123.0 Hz	179.9 Hz
77.0 Hz	127.3 Hz	186.2 Hz
82.5 Hz	131.8 Hz	192.8 Hz
88.5 Hz	136.5 Hz	203.5 Hz
94.8 Hz	141.3 Hz	210.7 Hz
100.0 Hz	146.2 Hz	218.1 Hz
103.5 Hz	151.4 Hz	225.7 Hz
107.2 Hz	156.7 Hz	233.6 Hz
110.9 Hz	162.2 Hz	241.8 Hz
114.8 Hz	167.9 Hz	250.3 Hz

USING SUB VFO B

The Sub VFO works in a similar manner to the Main VFO, with which you should be familiar by now. The Sub VFO provides simple split (transmit/receive) frequency operation via the combination of the MAIN VFO's RX and TX LED/Buttons and the SUB VFO's RX and TX LED Buttons, and, more importantly, dual-channel reception via the **[DUAL]** button. We'll get into those in a minute, but first let's look at how to control the Sub VFO.

Frequency, mode, and Clarifier data can be transferred from the Main VFO to the Sub VFO by pressing **[A▶B]**, but don't forget that this will overwrite any settings that were in the Sub VFO previously. Also, the contents of the two VFOs can be swapped (with no loss of data) by pressing **[A▶B]**.

Most selections for the Main VFO can also be made for the Sub VFO directly, by pressing **[SUB(CE)]** right before another keypad key to select a band, or before a mode button to change the Sub VFO mode (displayed below the Sub VFO frequency). When you press the **[SUB(CE)]** key, the entire display for the Sub VFO will blink, after which you have five seconds to press another key. Note that to switch VFO registers in the Sub VFO, you need merely press the **[SUB(CE)]** key followed by the key for the same band that the Sub VFO is already on.

- ❑ To set the Sub VFO (if it currently is on 7.000.0 MHz LSB) to the 14 MHz band, press **[SUB(CE)]** ⇒ **[14(5)]**.
- ❑ To change to USB, press **[SUB(CE)]** ⇒ **[USB]**.
- ❑ To set the Sub VFO's frequency to 14.225.00 MHz USB in one step, press **[SUB(CE)]** ⇒ **[ENT]** ⇒ **[1.8(1)]** ⇒ **[10(4)]** ⇒ **[3.5(2)]** ⇒ **[3.5(2)]** ⇒ **[14(5)]** ⇒ **[USB]** ⇒ **[ENT]**.

Unlike the Main VFO, with its triple-conversion receiver, the Sub VFO receiver uses double-conversion circuitry with 47 MHz and 455 kHz intermediate frequencies. Filters are selected automatically in the sub receiver, according to the operating mode. A 6-kHz AM filter and 2.4-kHz SSB/CW filter come installed from the factory. For CW work, a third optional 500-Hz narrow filter is also available from your dealer. After installation, this filter pathway must be enabled via *menu selection 5-8*. During operation, you can select this filter by pressing **[SUB(CE)]** ⇒ **[NAR1]** or **[SUB(CE)]** ⇒ **[NAR2]**.

Of course, you can tune the Sub VFO using its tuning knob, and use faster tuning steps by holding the **[FAST]** button (below the left side of the main tuning knob). You can use the large **DOWN(▼)** and **UP(▲)** keys (in both normal and 1-MHz fast steps) for the Sub VFO as well, if you just press the **[SUB(CE)]** key first.

About the only things you cannot do with the Sub VFO (that you can with the Main VFO), are store it directly into a memory, and set the Clarifier. For these functions you need to swap it with the Main VFO first (push **[A▶B]**, then hold the **[A▶B]** button for ½-second (to store it in a memory) or set the Clarifier, and then press **[A▶B]** again to return the data to the respective VFOs.

DUAL RECEPTION

Pressing the blue **[DUAL]** button activates the SUB VFO-B receiver. The "DUAL" indicator will appear at the left of the display, and the green "RX" LED above the **SUB VFO-B** tuning knob lights. Instead of pressing the blue **[DUAL]** button, you also can simply press the green "RX" LED, as this actually is a combined switch/LED.

Dual receive operation opens up exciting operating possibilities for split operation, contesting, and chasing elusive DX stations. For split-frequency DX pile-ups the ability to listen to both "sides" of the pile-up allows very precise timing of your calls. For contesting, dual receive allows you to continue a "run" on your "main" frequency while keeping an ear on a DX "multiplier" that might not be listening for your call area, for example.

The Main and Sub VFO share the same antenna and front-end bandpass filter, and so should be tuned fairly close to each other for maximum sensitivity (that is, within 500 kHz or so at low frequencies, or within several MHz at higher frequencies). Although you may be able to receive on, say, 21 and 28 MHz at the same time, you may find the SUB VFO-B receiver signal attenuated.

There are 12 BPF networks in the receiver front-end circuitry, each covering a particular segment of the transceiver's full receive range. SUB VFO-B receiver specifications are only guaranteed while tuning within the same bandpass as the MAIN VFO-A.

Main and Sub VFO Audio

The **AF GAIN** knob controls the Main VFO's volume level, and the smaller **SUB AF** knob controls the Sub VFO's volume. The effect these controls have on receiver audio can be changed, and is configured using *menu selection 4-9*. **AF GAIN** control knob operation can be set to either of the two following modes:

Separate - The receiver volume for the Main and Sub VFOs is adjusted independently. This simply means that the **AF GAIN** knob controls the MAIN VFO-A volume and the small **SUB AF** knob controls the Sub VFO's volume.

USING SUB VFO B

Balance - The **AF GAIN** knob adjusts the volume for both the Main and Sub VFOs simultaneously. The small **SUB AF** now functions as a “balance” control between Main and Sub audio levels.

Note - To “reverse” Main and Sub receiver audio at any time, press the **[AF REV]** button just to the left of the **DOWN(▼)/UP(▲)** keys so its LED lights. The functions of the **AF GAIN** and small **SUB AF** controls are now switched. Press the button again to return to normal operation.

Remember that when the Sub VFO is turned off by pressing **[DUAL]** again, the **AF GAIN** control configurations no longer apply.

Using Headphones for Dual Receive

To take advantage of dual reception, you will want to connect stereo headphones to the **PHONES** jack. Like the **AF GAIN** control, headphone audio mixing can also be configured as desired from *menu selection 4-8*. Three audio mixing schemes are selectable as follows:

Mono - Audio from both the Main and Sub receiver is combined equally in both ears (as from the loudspeaker when headphones are not used).

Stereo 1 - This is a combination of the audio from the two receivers and it gives you *some* audio from each channel in each ear, but with the Main receiver emphasized in the left ear, and the Sub receiver emphasized in the right ear, resulting in a kind of “3-D” spatial audio effect.

Stereo 2 - Audio from the Main receiver is only heard in the left ear, and audio from the Sub receiver is heard only in the right ear.

Note that both the Main and Sub VFOs must be activated (to put the **MARK-V FT-1000MP Field** into the dual receive mode), and the **AF GAIN** control(s) must be balanced (centered) to hear both receivers. Compare these two positions with both VFOs tuned to signals, to select the audio mixing scheme you prefer.

Also observe that the VRF, EDSP, RF GAIN, SHIFT, WIDTH, NOTCH, and AGC functions do not affect the sub receiver (AGC is automatically selected according to mode, or else from *menu selection 8-7*).

Headphone Audio Adjustments

The Main and Sub receiver audio levels available from headphone jacks **A** and **B** are manually adjustable. Underneath the top panel access cover are four trimpots allowing individual adjustment of Main and Sub audio for each headphone jack. With a headphone inserted into the appropriate jack, you can rotate these controls using a small insulated screwdriver for optimum level and balance. Refer to the drawing below for trimpot locations.

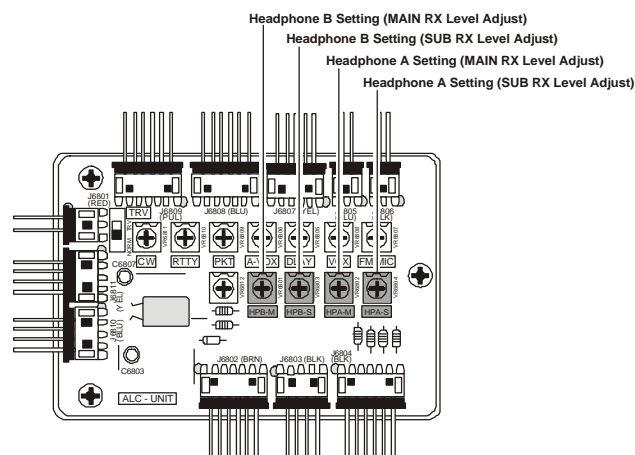

Caution!

Do not adjust **VR6812** control in the top access panel by mistake, as this will adversely affect meter tuning indication, requiring factory re-alignment!

USING SUB VFO B

SPLIT FREQUENCY OPERATION

Typical split operation involves receiving on the Main VFO-A or a memory channel, and transmitting on the Sub VFO-B. The special case of FM repeater operation uses some features of its own, and is described on page 59.

Rare DX stations often announce that they will “listen up” or “listen down” a few kHz (from their Tx frequency) when calling CQ or during contests to avoid being covered by the DX pileup from responding stations.

To activate Split operation, press the **(TX) Button/LED** above the Sub VFO's tuning knob. “**SPLIT**” will appear at the left of the display, and the red TX LED above the Sub VFO tuning knob will light up. Split operation can be activated with or without dual reception; however, we recommend that you have dual receive on, to allow you to monitor your transmit frequency on the Sub VFO (while receiving), as well as the Main VFO receiving frequency, so you don't accidentally “step on” somebody.

A few button functions you will need to know for split operation are explained below.

SUB VFO-B (TX) Button/LED - Pressing this button activates the Sub VFO for transmission.

[A▶B] - Pressing this key copies the displayed contents of the Main VFO into the Sub VFO, overwriting its previous contents.

[A↔B] - Pressing this key switches (“trades”) the displayed contents of the Main and Sub VFOs.

Split Operation Mode

The **MARK-V FT-1000MP Field** offers three modes of Split operation (chosen by *menu selection 8-2*):

Normal - In this default configuration, pressing **SUB VFO-B (TX) Button/LED** activates Sub VFO-B for transmission. Other settings (such as mode and frequency) must be manually set for the Sub VFO.

Auto - When **SUB VFO-B (TX) Button/LED** is pressed, Sub VFO-B is enabled for transmit, and the selected operating mode from Main VFO-A is automatically copied into Sub VFO-B. The transmission frequency must still be manually set for the Sub VFO.

A=B - Same as Auto mode above, however, a pre-set frequency offset (known as a “Quick Split”) is also applied to Sub VFO-B for transmission.

The “Quick Split” feature is handy when you know the offset a DX station will be listening on beforehand. The offset is applied instantly, saving time and mental arithmetic. It also ensures that you will not be transmitting on the DX station's TX frequency! A Quick Split offset up to ± 100 kHz can be selected in *menu selection 1-6*.

SUB VFO-B Settings

S-Meter - You can enable or disable the S-meter for the sub receiver via *menu selection 3-6*.

Peak-Hold - Additionally, if you want the “peak-hold” meter function (see page 41) for the Sub Receiver S-meter, it can be turned on/off by *menu selection 3-8*.

Tuning Steps - The Sub VFO's step size (0.625 ~ 20 Hz) is selected in *menu selection 1-4*.

Sub Receiver AGC - The AGC recovery time constant can be switched from automatic (default) to either fast or slow using *menu selection 8-7*.

Filters - When installed, the optional 500-Hz IF filter can be selected from the front-panel via *menu selection 5-8*.

Lastly, if you want to disable SUB VFO-B operation entirely, it can be turned off from *menu selection 7-8* (the display still appears and the SUB VFO-B knob can be turned, but nothing is received). While disabled, the sub receiver can be activated as a separate transmit VFO for split operation by pressing the **SUB VFO-B (TX) Button/LED**.

USING SUB VFO B

SIDEBAND DIVERSITY RECEPTION

Here you receive a single AM signal through the two receivers, each receiving the opposite sideband. Skywave-propagated signals often show phase distortion in this mode, but it gives you a view of the entire passband, from which you can then select the best sideband for listening (or for SWL Dx'ing, you may want to listen to both sidebands at the same time, to get the best copy). On groundwave signals, where the phase of the sidebands is likely to be the same, there is an interesting sense of depth to the signal.

To tune in a signal using this mode, you should have stereo headphones connected to the front panel **PHONES** jack, or an external stereo amplifier connected to the rear panel **AF OUT** jack.

- Set the Main VFO to either LSB or USB mode, and tune for zero beat on the desired signal.
- Press **[A ▶ B]** to copy this mode and frequency into the Sub VFO, then press the mode button to select the opposite sideband for the Main VFO.
- If using headphones, set the headphone mixing scheme to the Stereo 1 mode, and press **[DUAL]** to activate dual reception. Adjust the **AF GAIN** control(s) to balance the volume of the two receivers.

If interference is present on one of the channels, you may have to turn its **AF GAIN** control to suppress that channel (or press the green "RX" switch/LED to disable the receiver with the sideband experiencing interference). Otherwise, try changing the headphone audio mixing scheme to Stereo 2 or Mono in the menu selection for different effects (or try settings with similar effects on your external amplifier). Although you don't get the "stereophonic" effect in the monaural mode, the two signals are still mixed, offering the potential for much better copy than in regular AM or even single-sideband ECSS modes.

BANDWIDTH DIVERSITY RECEPTION

This mode involves receiving the same signal through two different bandpass filters. The frequency and mode of each VFO are the same. The main receiver provides a narrow bandpass, and the sub receiver a wide bandpass, resulting in a spatial perception of the channel. Although any mode (except FM) can be used, CW offers the widest array of choices, and perhaps the most startling effects on crowded channels.

Stereo headphones or an external stereo amplifier are recommended for this mode. To set up the transceiver for bandwidth diversity reception:

- Select the desired mode on the Main VFO, and the press the **[NOR]** or **[NAR1]** button (its LED will light up).
- Tune to the signal of interest.
- Press **[A ▶ B]** to copy this mode and frequency into the Sub VFO, then press the **[NAR 2]** button to select a narrow filter for the Main VFO.
- If using headphones, set the headphone mixing scheme to the Stereo 1 mode and press **[DUAL]** to activate dual reception. Next adjust the **AF GAIN** control(s) to balance the volume of the two receivers. If using an external amplifier, adjust its balance control.

You also may find it interesting to try the **SHIFT** and **WIDTH** controls (on the Main receiver) for some interesting effects.

Before retuning, remember to press **[DUAL]** to turn off dual reception.

VFO TRACKING

To have Sub VFO B track the Main Receiver VFO while tuning (with dual reception on or off), simply *hold* the **[LOCK]** button depressed.

With **[LOCK]** depressed, the "**TRACK**" indicator appears when the main tuning knob is rotated, and the Sub VFO tracks the Main receiver. Release the button to resume normal tuning.

Memory Features

MEMORY STRUCTURE

The **MARK-V FT-1000MP Field** contains ninety-nine regular memories, labeled 1-1 through 1-99, nine special programmed limit memories, labeled P1 through P9, and five QMB (Quick Memory Bank) memories, labeled C1~C5. Each stores the Main VFO's frequency and mode, IF filter selections, Clarifier on/off and offset settings, as well as Repeater Shift status (if appropriate). By default, the 99 regular memories are contained in one group; however, they can be arranged in up to 5 separate groups if desired.

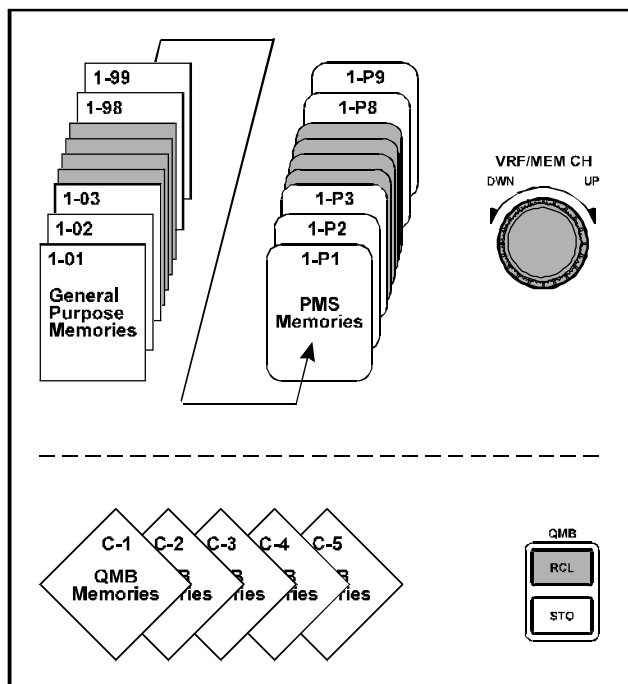

Like during VFO operation, you can freely tune and change the mode or Clarifier settings and you can also copy settings from one memory to another. In fact, you can do nearly anything with a memory that you can with the VFOs, except for the special PMS memories (P1~P9), described later.

The [VFO/MEM], [A▶M], [M▶A] and [MCK] buttons and VRF/MEM CH knob are used to control various memory operations, as follows:

- ❑ [VFO/MEM] - This toggles control between memory or VFO operation. If a displayed memory has been re-tuned, pressing [VFO/MEM] *once* returns to the originally-memorized frequency, and pressing it again returns to the last-used VFO.
- ❑ [A▶M] - When receiving on a VFO or re-tuned memory, pressing and holding in this key for ½ second stores the current operating data into the currently selected memory. Two beeps sound, and any previous data in that memory register will be overwritten. *Momentarily* pressing this key activates memory checking ("MCK" blinks) for 3 seconds. This is described in the next section on memory storage and recall.
- ❑ [M▶A] - Pressing and holding in this key for ½ second copies the frequency and operating data stored in a selected memory into the Main VFO. *Momentarily* pressing this key activates memory checking ("MCK" blinks) for 3 seconds. This is described in the next section on memory storage and recall.
- ❑ [MCK] - Pressing this key also activates memory checking (to look at the current contents of a memory or memories) and displays the contents of the memory channels in the right Sub VFO display.
- ❑ VRF/MEM CH - This knob selects the memory channel while memory operation. However, when the VRF feature is engaged, this knob tunes the passband of the narrow input "preselector" filter. In this instance, press this knob momentarily to change this knob's operation to that of memory channel selection.

MEMORY PROGRAMMING

Memory programming allows storing your favorite or often-used frequencies into memory channels for long-term storage and quick recall. The **MARK-V FT-1000MP Field** memories are retained after power-off by a long-life lithium backup battery that should not need to be replaced for more than 5 years. Should you expect to not use your transceiver for extended periods, you can switch off the backup battery via the rear panel switch to conserve lithium backup battery life (see page 114).

Auto Channel-Up

Normally, you must manually increment the channel number when programming consecutive memories. If you would like to save time and have the channel number automatically increment after writing each memory, this can be enabled in *menu selection 0-8*.

COPYING VFO-A DATA TO SELECTED MEMORY

You can store the frequency and all operational settings for the displayed (Main) VFO into a memory channel by following this simple procedure:

- ❑ Set up all operating parameters and frequency as desired on the Main VFO.
- ❑ When the VRF feature is engaged, press the **VRF/MEM CH** knob momentarily to change the **VRF/MEM CH** knob's operation to that of memory channel selection.
- ❑ Rotate the **VRF/MEM CH** knob to select the memory channel to fill ("MCK" will start blinking).
- ❑ When you have chosen a channel into which to store the frequency data, press and hold in **[A▶M]** for ½ second so that two beeps sound. The VFO contents are now stored in the selected memory channel; at this point, you remain in the VFO mode, so you can continue tuning around and/or storing additional memories.

Notice

Regarding the VRF/MEM CH Knob

When the VRF feature is engaged, the **VRF/MEM CH** knob tunes the passband of the narrow input "Preselector" filter. During Memory operation, to enable memory channel selection, press the **VRF/MEM CH** knob momentarily; rotation of the knob will now allow you to select other memories. And if you want to enter the "Memory Tune" mode and step around in channelized steps (per the setting of *menu selection 1-5*), press and hold in the **VRF/MEM CH** knob for ½ second.

Basic Memory Storage Procedure

Step 1

Set up MAIN VFO parameters (such as band, frequency, mode filters, clarifier offset etc.) as desired.



Step 2

Press **[A▶M]** momentarily (or rotate **VRF/MEM CH** knob) to activate memory checking.



Step 3

Rotate the **VRF/MEM CH** selector to display the desired memory to program.

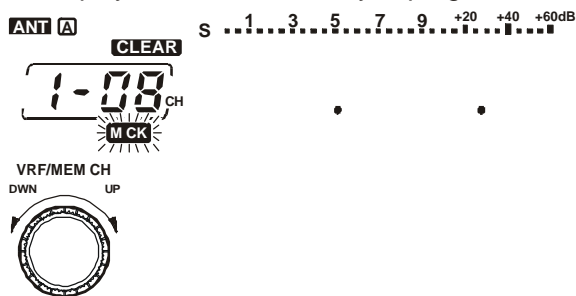

Step 4 -----> Finished!

Hold **[A▶M]** until two beeps sound to store VFO data into the selected memory.

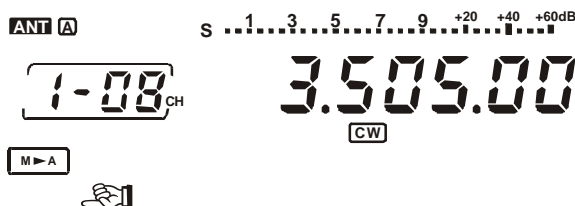

Memory Features

RECALLING & OPERATING ON MEMORY CHANNELS

To recall a memory stored per the previous section, you first must switch to the “Memory” mode. To do this, while operating on the Main VFO, press [VFO/MEM]. The last-utilized memory’s contents will appear in the main frequency display field. To return to VFO operation, just press [VFO/MEM] once more; the VFO’s contents will have remained undisturbed.

While operating in the memory mode (if you haven’t yet re-tuned it - see below), the “MEM” indicator is displayed instead of “VFO,” and you can now rotate the VRF/MEM CH knob or press the microphone UP/DWN buttons to select any previously-stored memories for operation.

Pressing and holding in the [M▶A] key for ½ second copies the current memory channel data into VFO-A. You can now tune around on the Main VFO, having used the memory channel’s frequency as a starting point. When you press and hold in [M▶A], you lose the previous contents of the Main VFO, and if you were receiving on the VFO, operation shifts to the frequency and mode just copied from the memory.

Pressing the [M▶A] key momentarily shows you the contents of the memory, without overwriting VFO-A data. This is a momentary version of the [M CK] key’s action.

MEMORY TUNING

With this mode, you can emulate VFO tuning and operation on a memory channel and retain the memory checking feature: if you change frequency, mode or Clarifier settings, “MEM” is replaced with “MTUNE”. During memory tuning, the microphone UP/DWN buttons now duplicate tuning knob functions like VFO operation (rather than select memory channels as before). Pressing [VFO/MEM] once cancels any re-tuning changes to the memory and reverts to the memory recall mode (“MEM” displayed again). Pressing [VFO/MEM] once more returns the transceiver to VFO operation.

Memory Tuning makes operation on memories 1 to 99 just as flexible as the VFOs (memories P1 ~ P9 have special additional features, described later). If you want to save changes to a re-tuned memory channel, use the same procedure you use to store the VFOs to memory: Press [VFO/MEM] momentarily, and rotate the VRF/MEM CH knob to select another memory (if desired), or just hold [A▶M] for ½-second until the double beep sounds (to overwrite the current memory with the re-tuned data).

The labeling and function of [A▶M] during memory tuning is somewhat deceptive as the VFO settings, which are hidden at this point, are not involved in this operation at all, since those of the recalled memory have taken their place.

Important Note: Computer software programs utilizing the CAT system interface port may presume that the transceiver is operating in the VFO mode for certain features like “band mapping” and/or frequency logging. Because the “Memory Tune” mode so closely resembles the VFO mode, be sure that you have the **MARK-V FT-1000MP Field** operating in a control mode compatible with your software’s requirements.

MEMORY CHECKING

Before storing or recalling a memory, you will usually want to check its contents. One memory channel number is displayed at all times (just to the left of the CH indicator at the right center of the display). You can change the selected channel number by rotating the VRF/MEM CH knob.

If you rotate this knob while receiving on the VFO or a re-tuned memory, “MCK” blinks beneath the channel number, and the mode and frequency previously stored in the selected channel will be displayed in place of the SUB VFO-B display. For three seconds after you stop turning the knob. If the memory is vacant, “CLEAR” appears above the channel number and nothing is displayed except two decimal points.

You can also view memories by pressing [M CK], in which case memory data is continuously displayed (“MCK” remains on and doesn’t blink). You must press [M CK] again to return the display to the VFO.

Momentarily pressing either [A▶M] or [M▶A] also activates memory checking. As mentioned before, “MCK” blinks as the frequency and mode indicators change to show the contents of the last-selected memory. If you touch nothing else, the display reverts to your current operating parameters automatically after 3 seconds. By turning the front panel VRF/MEM CH knob before the 3 seconds expires, you can select for display each of the general purpose and PMS memories. Pressing these buttons restarts the 3-second timer, so as long as you are changing channels, memory checking mode persists.

Note: When checking memories, both vacant and filled memories are displayed. If you would like to skip over vacant memories, press the [FAST] button before memory checking.

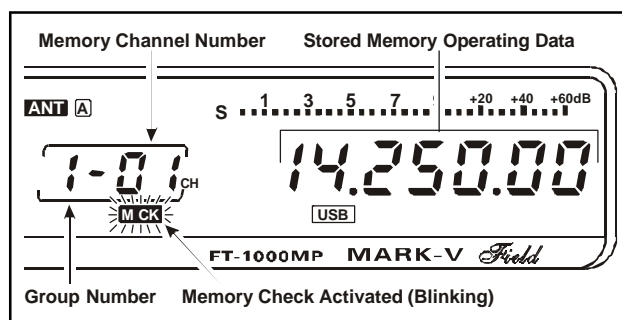

RECALLING & OPERATING ON MEMORY CHANNELS

COPYING A SELECTED MEMORY TO VFO-A

If desired, you can store the frequency and all operational settings for the selected memory channel into the Main VFO. While operating in the Memory mode:

- ❑ When the VRF feature is engaged, press the **VRF/MEM CH** knob momentarily to change the **VRF/MEM CH** knob's operation to that of memory channel selection.
- ❑ Rotate the **VRF/MEM CH** knob ("MCK" blinks) to select the memory channel to copy.
- ❑ Press and hold in the [**M▶A**] key for ½ second so that two beeps sound. The memory channel data is now copied to the Main VFO, and you are left operating on the VFO.

COPYING BETWEEN MEMORIES

The same procedure for copying VFO-A into memories is also used to copy one memory to another. Like VFO-A, one memory can be selectively copied; however, there are a few differences.

To copy from one memory to another (including PMS memories), first activate memory tuning by simply turning the VFO dial so that "M-TUNE" appears (and then tuning back to the desired frequency). Rotate the **VRF/MEM CH** knob to select a memory to fill, then (within 3 seconds) press [**A▶M**] to copy the contents from the re-tuned (source) memory to the destination memory.

GROUPING MEMORIES

The 99 regular memories and PMS memories P1~P9 can be grouped among up to five memory banks, if desired. Memory grouping is configured by *menu selections 0-1* through *0-5*.

By default, Group 1 is filled with all memories; Groups 2~5 are disabled (empty). Group 2 is enabled by not filling group 1 to capacity, and carrying over the extra memories, and so on. You could fill Group 1 with memories 1~20, for example, and carry over memories 21~99 and P1~P9 to Group 2, or else you can apportion them among Groups 2~5, as desired. Remember that to carry over memories from one group to the next, the preceding group must not be filled to capacity (i.e., the group holding memory channel P9 is the last enabled group).

Limiting Memory Group Operation

If you have assigned filled memories into more than one group (as explained on the previous page), you can enable a particular group and limit memory recall and scanning operation (covered later) only to those memories in that selected group, if so desired.

To do this, simply rotate the **VRF/MEM CH** knob so that any memory channel number in the desired group is displayed, then press the [**M GRP**] button just above and to the left (see box below). The "GROUP" indicator appears and you will find that only memories within that group are now available for recall and operation.

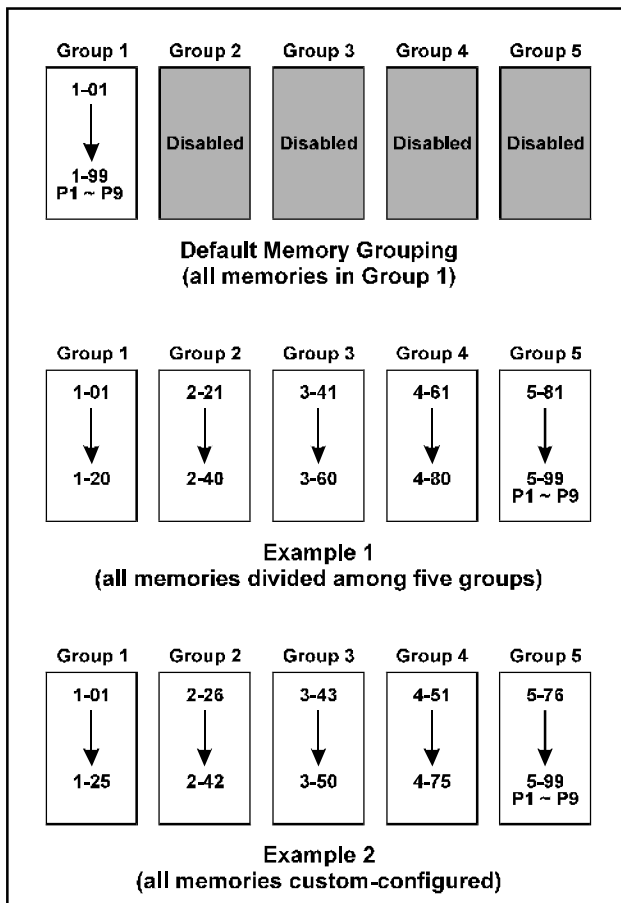

Notice

Regarding the VRF/MEM CH Knob

When the VRF feature is engaged, the **VRF/MEM CH** knob tunes the passband of the narrow input "Preselector" filter. During Memory operation, to enable memory channel selection, press the **VRF/MEM CH** knob momentarily; rotation of the knob will now allow you to select other memories. And if you want to enter the "Memory Tune" mode and step around in channelized steps (per the setting of *menu selection 1-5*), press and hold in the **VRF/MEM CH** knob for ½ second.

Memory Features

RECALLING & OPERATING ON MEMORY CHANNELS

QMB (QUICK MEMORY BANK) OPERATION

The Quick Memory Bank is comprised of five memories (labeled C1 ~ C5) independent from the regular and PMS memories. These can quickly store operating parameters for later recall. You might find this handy to use when you have tuned a station of interest that you want to save, but don't want to overwrite your regular or PMS memories, especially if you have them organized a specific way.

You can use the QMB memories the same way you would a notepad in your shack - for jotting down (saving) frequencies and modes to come back to later. There are five QMB memories enabled by default; however you can disable some if desired, using *menu selection 0-6*.

- To store a frequency into the first Quick Memory (C-1), simply press [STO].
- Stored Quick Memories are recalled by pressing [RCL] repeatedly to select the desired memory ("QMB" will be displayed at the left, and the Quick Memory channel number will be displayed in the memory box, as shown below).

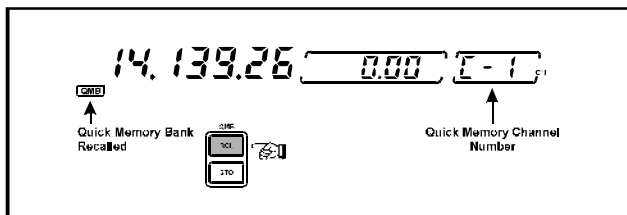

Additional settings will be entered directly into C-1, with previously-stored entries then being shifted to the next available Quick Memory. This "stacking" system keeps the most recent entry in the first memory, and automatically shifts older entries into the next consecutive memory. After all Quick memories have been filled, additional entries overwrite previous ones on a "first-in, first-out" basis (as shown inside the box below).

- To revert from QMB operation back to VFO-A, simply press [VFO/MEM] once.

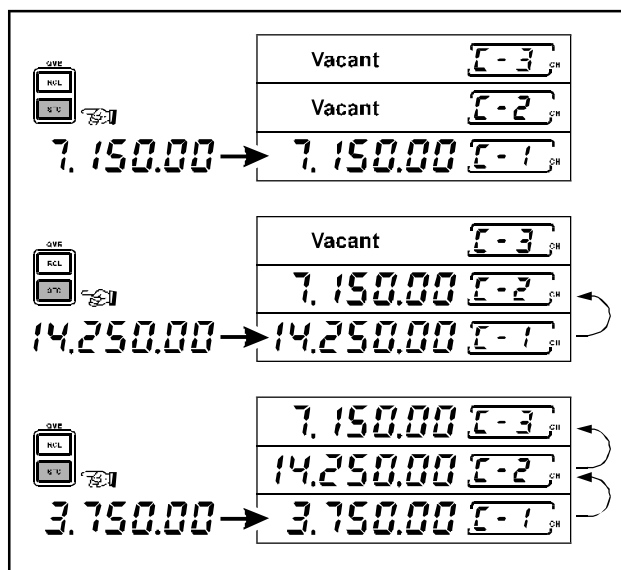

VFO SCANNING

You can start scanning on the Main VFO by holding the microphone **UP** or **DWN** button for ½ second (the receiver squelch does not have to be closed in this case). To increase the scan speed (x10) press either the microphone **FST** button (momentary-type) or the front panel **[FAST]** button. Scanning continues up or down until a button is pushed, or else “loops-around” when the upper or lower receiver limits are reached.

Scan speed is determined by the receiver “dwell time” using *menu selection 2-4*. Dwell time is the duration that each channel is sampled for activity as the receiver scans up or down and is adjustable from 1 msec (fast) to 100 msec (slowest). Try experimenting with different durations until you reach the desired scan rate.

Auto Memory Write

While scanning the VFO or a retuned memory, you can have the **MARK-V FT-1000MP Field** automatically write active channels into memories for later recall and scanning. As scanning pauses on activity, frequency information is written into available memories in any desired Memory Group, or all enabled groups, until full. You can leave scanning unattended, if desired, then return later to recall and check memories for station activity.

To enable this feature, recall *menu selection 2-5*, and select the desired Memory Group (GROUP x), ALL GROUPS, or OFF. Follow the procedures outlined for *VFO Scanning, Memory Tuning*, and also review the descriptions for *Scan Resume Modes*. Remember that for scanning to stop on activity, the squelch must be closed.

MEMORY SCANNING

The 99 memories in the **MARK-V FT-1000MP Field** offer some choices regarding how they are scanned, and, after the following brief description, you can decide how to tailor scanning for your operating needs.

When receiving on a recalled memory (with “**MEM**” displayed), you can scan all stored memories by just holding the microphone **DWN** or **UP** button for ½-second to start. If you want scanning to pause on signals, you must first adjust the **SQL** control to silence the receiver (green “**MAIN BUSY**” indicator off) on a clear channel. Scanning pauses on any channel having a signal strong enough to open the squelch, and the two decimal points in the frequency display blink. You may need to readjust the **SQL** control to prevent scanning from stopping on only background noise. Scan speed is not affected by the microphone or panel **[FAST]** buttons, but is configured by *menu selection 2-3*. The memory scanning “dwell time” is adjustable from 100 (fast) ~ 1000 msec (slow).

To stop scanning, press the **PTT** switch (no transmission will occur), or a microphone button again. When scanning, keep in mind that the IPO and ATT selections also affect the squelch threshold by changing receiver front-end sensitivity.

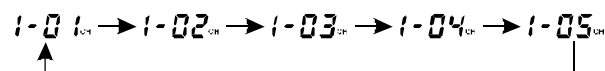

MEMORY SCAN SKIP

By default, all programmed memories are included for scanning. However, you can “flag” some of them to be skipped while scanning. To do this, recall the memory you want to be skipped, and hold either the front panel or microphone **[FAST]** button while pressing **[M CK]** momentarily so the “dash” between the group number and memory channel number disappears. If you have flagged a memory to be skipped, and later want to enable it again, just repeat the **[FAST]** + **[M CK]** procedure.

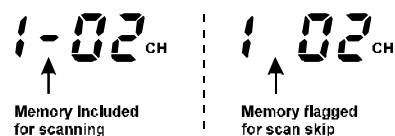

Scanning Features

MEMORY SCANNING

MEMORY “MASKING”

You may want to hide some memories from operation, to simplify selection of others. To mask a displayed memory, while “MEM” is displayed, *press and hold* in [A►M] for ½ second until the double beep sounds. But be careful: if you do this instead while “M TUNE” is displayed - that is, after retuning the memory, the retuned data will overwrite the original memory data, but it will not be masked. So, if you have re-tuned the memory and don't want to save the changes, cancel them first by pressing [VFO/MEM] once, and then hold [A►M] for ½ second. No frequency digits appear for masked memories - just the two decimal points remain.

Masked memories are also skipped during scanning. If you don't overwrite a masked memory, you can unmask it simply by repeating the same procedure you used to mask it.

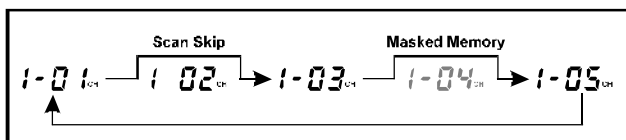

SCAN RESUME MODE

There are three choices that determine how scanning will respond when activity is detected. Scan resume operation is configured by recalling *menu selection 2-1*, and choosing the desired mode. Below is an outline of each scan resume mode and how it operates.

Carrier Stop (default) - With the squelch closed, scanning pauses on signal activity, then resumes soon after the carrier disappears. With the squelch open, scanning will not continue unless the receiver is quieted again (**SQL** control).

Carrier Timed Stop - With the squelch closed, scanning pauses on activity, then resumes automatically after a preset duration (5 seconds by default), whether signal activity remains or not (time-delay resume).

Carrier Timed Slow - With the squelch closed, scanning slows down (but doesn't stop) for a preset duration (5 seconds by default), when activity is detected.

For the Timed Stop and Timed Slow modes, the pause duration can be set between 1 and 10 seconds with *menu selection 2-7*, or the scan pause (resume) feature can be disabled completely using *menu selection 2-0*. If disabled, scanning will not stop for any activity.

SCAN SKIP DISABLE

After programming many memories, you may have tagged specific ones to be skipped during scanning. Should you later change your mind and want to scan all of them again, you don't have to go back and re-enable each tagged one (there's an easier way!).

Recall *menu selection 2-6* and change the “Scan All” setting from off to on. The memory tags are still retained, but ignored when this setting is turned on. To return to selective scanning, simply change the setting to “Off.”

PROGRAMMED MEMORY SCANNING PMS MEMORIES P1 ~ P9

To limit scanning (or tuning) to within a particular frequency range, you can use Programmed Memory Scanning (PMS) provided with nine special-purpose memories (P1 ~ P9). First, store the upper and lower frequency limits of the range in a consecutive pair of PMS memories (i.e., P1 & P2, P2 & P3, etc). For example, P2 might contain the lower edge and P3 the upper. Next recall the first memory of the pair that hold the range you want to scan or tune, then nudge the main VFO knob to activate memory tuning (“**PRGM**” appears). Tuning and scanning are now within the limits of the selected PMS memory pair, keeping operation inside this programmed range.

Example: Limit tuning and scanning to the 17-m amateur band’s limits.

- ❑ Press [**VFO/MEM**] as necessary, to display “**VFO**.” Tune to the low edge of the 17-m band: 18.068 MHz, and select the desired mode (here, USB or CW).
- ❑ Rotate the **VRF/MEM CH** knob, and select memory P1. Then (while “**MCK**” is still blinking) hold in the [**A ► M**] key for ½ second to write the VFO’s frequency into P1.

- ❑ Press [**VFO/MEM**] to select the VFO, and now tune to the high edge of the 17-m band (18.168 MHz). Be sure that the operating mode has not changed.
- ❑ Rotate the **VRF/MEM CH** knob, then select memory P2. Hold in the [**A ► M**] key for ½ second to write the VFO’s frequency into P2.
- ❑ Now recall memory P1, and turn the tuning knob slightly (to activate memory tuning).

Tuning and scanning are now limited to the 18.068- to 18.168-MHz range until you press [**VFO/MEM**] to return to memory channel or VFO operation. During PMS operation, you can also press (and hold in) [**A ► M**] to copy the displayed frequency to a memory, or [**M ► A**] to write the displayed frequency to a VFO.

Notice

Regarding the VRF/MEM CH Knob

When the VRF feature is engaged, the **VRF/MEM CH** knob tunes the passband of the narrow input “Preselector” filter. During Memory operation, to enable memory channel selection, press the **VRF/MEM CH** knob momentarily; rotation of the knob will now allow you to select other memories.

EDSP

Enhanced Digital Signal Processing uses A/D (Analog to Digital) and D/A (Digital to Analog) conversion techniques under microprocessor control to achieve significant enhancement of signals at the audio and low-frequency IF levels. The major capabilities offered by EDSP lie in the area of heterodyne/random noise reduction and audio bandpass filtering. Digital filters have many advantages over their analog counterparts in that they can meet tighter specifications on parameters such as voltage and temperature drift and noise problems. And the hybrid filter architecture of the **MARK-V FT-1000MP Field**, utilizing extensive analog IF filtering to protect the DSP circuitry which follows, guarantees superior strong-signal performance under crowded band conditions.

The **MARK-V FT-1000MP Field** uses a 16-bit NEC μ PD77016 CMOS digital signal processor chip featuring a 30-nS Instructions Cycle, 33 MHz Clock frequency, a 16 x 16-bit and 40-bit multiply accumulator, 40-bit Barrel Shifter, and 64 K Bytes Program ROM.

DSP enhancement is basically a four-step process. Audio (or EDSP IF) input is sampled several thousands of times per second, then the frequency and amplitude of the audio are converted into a digital representation of the analog waveform that resembles ascending and descending "staircases" by the A/D (analog-to-digital) converter. This is later changed into digital serial bitstream as raw data for analysis and processing.

Information is extracted from digital data, and the EDSP chip performs complex mathematical calculations according to pre-programmed routines known as algorithms. Algorithms are processed then compared against a set of parameters (or threshold if you will) based on a phenomenon known as "correlation." The degree of correlation depends on the incoming signal's characteristics: random noise has relatively little correlation, speech contains moderate correlation, with heterodynes (and QRM) being highly correlated. The EDSP microprocessor is programmed with various parameters corresponding to different known audio phenomena.

EDSP allows the frequency spectrum of a received signal to be modified according to a specific set of parameters for the desired effect (QRM reduction, audio tailoring, etc.). Certain types of audio interference leave a distinctive signature or "footprint," which can be recognized, and "processed out" of the digitally-reconstructed audio from the EDSP chip. Also, digital filters are constructed which emulate traditional low-pass, high-pass, band-pass, and band-stop filters, except with steep skirt shaping and performance possible with digital technology. EDSP also allows direct "digital" demodulation of audio for receive, as well as direct modulation of audio for transmit.

Advanced Features

EDSP

EDSP FUNCTIONS

The EDSP circuitry in the **MARK-V FT-1000MP Field** allows digital enhancement of both transmitted and received audio. A basic primer on DSP was given to inform you more about this capability than just the panel label and button location. Now you can customize its filtering capabilities and use it to reduce QRM and tailor audio response for each operating mode.

EDSP Modulation

TX Audio Enhancement (Menu 4-4)

Four microphone audio responses can be chosen using *menu selection 4-4*. Since voice audio characteristics vary between people, these settings enable tailoring your transmitted audio for best clarity.

TX IF Filter Selection (Menu 5-9)

Normally, 2.4 kHz filters are selected for both the 455 kHz and 8.2 MHz Tx IF. However, with EDSP operation, you can keep the 2.4 kHz filter, or select the 6.0 kHz filter for maximum bandwidth and better frequency response on your transmitted audio. The resulting effect of this filter selection is directly related to *menu selection 7-7* (below). The desired filter is chosen with *menu selection 5-9*, and is only active when EDSP is turned on. Note that your signal's actual bandwidth on SSB will not exceed that set by the IF analog filter, with a (-6 dB) bandwidth of approximately 2.4 kHz being typical.

EDSP Modulation/Demodulation (Menu 7-7)



TX EDSP Modulation - Early-stage transmitted SSB audio may be applied directly to the EDSP circuitry for processing, bypassing the analog modulator. EDSP filter parameters can be matched to voice characteristics for optimum audio tailoring.

RX EDSP Demodulation - For SSB, CW and AM, receiver 3rd IF output is applied directly to EDSP circuitry for demodulation and processing, bypassing the analog product detector. Reduced noise is a primary benefit of the EDSP Demodulator, which may be used alone or in conjunction with EDSP filtering.

Menu selection 7-7 configures the settings for both the Rx and Tx EDSP modulation circuits (see table at the right). Note also that if the EDSP is turned off via *menu selection 0-9*, these circuits will revert to their analog counterparts.

EDSP RX AUDIO ENHANCEMENT

EDSP Contours

QRM reduction is accomplished by utilization of the various DSP filter networks. The front **CONTOUR** buttons select Low- () Mid- () and High-cut () filters, along with a band pass filter selection (see below).

The low-, mid-, and high-cut filters are pre-set for different audio emphasis, using mathematical algorithms developed after thousands of hours of on-the-air testing.



The bandpass filter, activated when the **[IDBT]** button on the **Shuttle Jog** is pressed, is automatically programmed to match the analog IF passband established by the setting of the **WIDTH** and **SHIFT** controls. No manual adjustment is required.

This **CONTOUR** LED indicates the current status of the EDSP Contour feature:

- Glowing Green: Low-cut filter selected,
- Glowing Orange: Mid-cut filter selected,
- Glowing Red: High-cut filter selected,
- Off: EDSP Contour Off.

In actual operation, it may be very difficult to “predict” which Contour response will best enhance the signal-to-noise recovery. So under difficult conditions, you should change selections often; don't be surprised if one selection suddenly causes the incoming signal to “jump” out of the background noise.



EDSP CONTOUR SELECTIONS		
CONTOUR Selection	Filter Type	Application
	LCF (Low - Cut)	high-freq. emphasis
	MCF (Mid - Cut)	high & low freq. emphasis
	HCF (High - Cut)	low-freq. emphasis

EDSP MODULATION & DEMODULATION MENU SELECTION “7-7”	
Mode	Settings
SSB (RX)	OFF 100 ~ 3100 Hz 300 ~ 2800 Hz
SSB (TX)	OFF 100 ~ 3100 Hz 150 ~ 3100 Hz 200 ~ 3100 Hz 300 ~ 3100 Hz
CW (RX)	OFF ON (100 ~ 3100 Hz)
AM (RX)	OFF ON (70 ~ 3800 Hz)

EDSP

EDSP NOISE REDUCER

Noise reduction is accomplished by utilization of one of the four settings selected by the front panel [NR] button. Press the [NR] button to toggle between Noise Reduction "A," "B," "C," "D," and "OFF." Each setting has correlation parameters optimized to reduce random noise, static, pulse/man-made noise and heterodynes, with little degradation of the desired signal. As with the Contour feature, it is difficult to predict which setting will be most effective under current noise conditions, so experiment with the settings as conditions change.

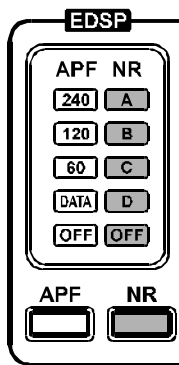

EDSP APF (AUDIO PEAK FILTER)

In the CW mode, the front [APF] button sets the bandwidth of the EDSP's CW peaking filter. Press the [APF] button repeatedly to toggle between bandwidth selections "240 Hz," "120 Hz," "60 Hz," "DATA" (which is optimized bandwidth for FAX, PACKET or SSTV operation), and "OFF."

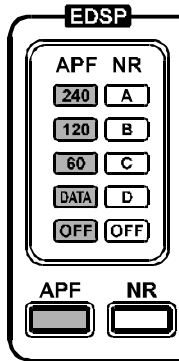

IDBT

(INTERLOCKED DIGITAL BANDWIDTH TRACKING) SYSTEM

You can control the EDSP Contour's "Bandpass" filter characteristics according to the **SHIFT** and **WIDTH** knobs' settings. To do this, press the [IDBT] button on the right side of the **Shuttle Jog** to activate the IDBS feature. Doing so will automatically program the bandwidth of the Bandpass Contour filter to match the IF bandwidth set by these two controls; therefore, if you have narrowed the IF passband to 1.9 kHz using the **WIDTH** and **SHIFT** controls, the IDBT feature will automatically set the Contour filter's Bandpass mode to 1.9 kHz, as well.

The **IDBT** feature is only available in the USB and LSB modes.

EDSP AUTO MULTIPLE NOTCH FILTER

On page 48, we previously discussed basic IF notch filter operation and how it is used to attenuate heterodynes. EDSP offers multiple-notch capability within the AF (rather than IF) bandpass with the press of a button. With the conventional (455 kHz 3rd IF) notch filter, by comparison, only a single offending heterodyne at a time can be attenuated by pressing the [NOTCH] button and slowly rotating the **NOTCH** control. Notch tuning can sometimes be critical, as you have to position the control for maximum "depth" by ear.

With the multiple notch, the EDSP circuitry examines the AF bandpass and the correlation of the signals present. After correlation parameters are compared, unmodulated signals (heterodynes) are identified and notched out. As EDSP dynamically checks the audio, new heterodynes will be identified and notched, one by one, as they appear. See the illustration below.

Theoretically, an infinite amount of notches could be inserted to attenuate each new heterodyne; however, the total notch bandwidth would approach that of the audio passband, and, progressively notch all audio. One limitation of the EDSP auto multiple notch feature is that it is only for use with SSB modes; attempting to use it on CW would cause the CW signals to *disappear* - not the desired function of a CW filter!

The effect of the EDSP notch filter will not be observed on the S-meter, as the EDSP is outside of the AGC circuit's loop. The manual IF notch, however, *is* within the AGC loop, so you should use the IF notch for particularly strong interference sources.

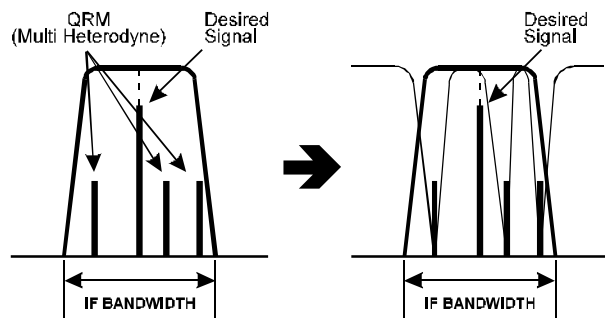

EDSP Auto Multiple Notch Action

EDSP

The two Notch circuits may be enabled and/or disabled using *menu selection 2-9*. It is important to take note of the selection options available:

IF NOTCH - Manual IF notch operation using the front panel knob with the same name. The EDSP notch is not accessible in this mode.

AUTO DSP - When EDSP is engaged (the green "EDSP" LED is lit), the **[NOTCH]** button serves as an On/Off switch for the EDSP auto-notch filter. The EDSP notch filter automatically locates existing heterodynes and notches them out. Any additional heterodynes are also notched as they appear. The IF Notch is accessible only when the EDSP is turned off.

SELECT - If EDSP is engaged (*menu selection 0-9* not set to "off"), and the **[NOTCH]** button is pressed, both the EDSP Auto-Notch *and* IF notch operation take effect simultaneously. If EDSP is disabled via *menu selection 0-9*, the IF Notch will still be available.

Note that there is a "short-cut" available, affording easy access to *menu selection 2-9*. Just press and hold in the **[FAST]** key, and press the **[NOTCH]** button.

Important Note About EDSP

An advantage of EDSP is the flexibility for the user to customize or "tailor" received and transmitted audio. *Menu selections 4-4, 5-9, and 7-7* each have distinct effects on the sound of your transmitted audio. The "ultimate" combination of these settings will of course vary between users personal taste, and for the desired effect (distinctive audio, QRM penetration, etc.).

The easiest way to immediately hear the effect of different EDSP settings is to use the transceiver's built-in MONITOR circuit to listen to your audio while transmitting. In this way, you can step through the various setting combinations, and select the ones that appeal the most to you, or the receiving station.

Advanced Features

REMOTE CONTROL OPERATION

INTRODUCTION

You can select and activate various transceiver functions via the optional **FH-1** Remote Control Keypad (available from your Yaesu dealer) connected to the **REMOTE** jack on the rear panel of the transceiver.

Four transceiver remote control features are available via *menu selection 7-9*. Once the desired remote control operating mode is selected, pressing a key activates one of the functions available in that operating mode; the function activated by a key closure might be a CW message playback, a contest number being incremented upward, or a front panel function being duplicated.

The four remote control features available are:

- I. **Contest Memory Keyer** - The recording and playback of repetitive contest messages are accomplished via the keypad.
- II. **VFO/Memory Function Control** - In this mode, the remote control keypad duplicates the front panel keys that relate to VFO/Memory selection and programming.
- III. **Main VFO-A Control** - In this mode, the remote control keypad duplicates the functions of the front panel **BAND** keypad (keys "0" ~ "9"), plus **[SUB(CE)]** and **[ENT]** as applied to the Main VFO.
- IV. **Sub VFO B Control** - Same as above, except keypad inputs are applied to the Sub VFO.

The features and programming techniques for the remote control features are discussed below, beginning with the contest memory keyer.

I. CONTEST KEYS CONTROL

The **MARK-V FT-1000MP Field** includes a contest memory keyer which includes a number of automated features which reduce operator fatigue during long hours of contest operating.

Features

The keyer offers six CW message memories that can be used to store your callsign and/or repetitive messages like "CQ TEST DE <callsign>" or "TU QRZ <callsign>." Additionally, a three- or four-digit contest serial number "001, 002...." may be imbedded into the first memory location for contest exchange use. The contest number can be incremented/decremented manually, reset to an arbitrary number (in the middle of a contest), and can also be played back using "cut" numbers ("5NN TT1, 5NN TT2..."), if desired.

Linear amplifier or external antenna tuner adjustment may also be assisted, thanks to the momentary **[TUNE]** key on the keypad. Via *menu selection 4-3*, the tune-up power output may be limited to a maximum of 25 or 10 Watts, instead of the usual 100 Watts, and the **[TUNE]** then serves as a momentary (push and hold) key which activates the transmitter and puts out a carrier for tuning purposes.

Let's now look at the storage and recall capabilities of the contest memory keyer.

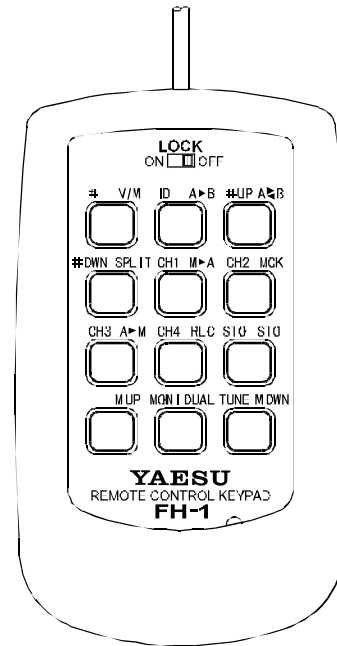

REMOTE CONTROL OPERATION

1. Contest Number Memory

The [#] key allows storage of a message of up to 20 characters in length. Within this message, a contest sequential serial number may be imbedded during the programming process by sending “???” (three Question Marks) in the place where the contest number is desired. The Question Marks should be separated only by a letter space, not by a word space. Thus, to send “5NN 001, 5NN 002,” and so forth, you send “5NN ???” (not “5NN ? ? ?”) during memory storage.

A contest number may only be imbedded in the memory location activated by [#] key.

You can manually increment or decrement the number (in case you need to repeat or “catch up” to the correct contest number) by pushing the [#UP] key to increment, or the [#DWN] key to decrement.

To reset an arbitrary contest number (in the middle of the contest, when you may have been using a different transceiver on a different band, for example), select *menu selection 7-3*. Now rotate the Main Dial to select the next-to-be-used contest number, and press [ENT] to save your new number and exit.

To abbreviate certain numbers in the contest exchange, select *menu selection 7-6*. In this Menu area, substitutions of Morse letters for (longer) numbers can be accomplished. For example, the keyer may be commanded to send “T” for “Zero,” “A” for “One,” “U” for “Two,” and “N” for “Nine” while leaving all other numbers in their normal (longer) formats.

See the chart below for details of the selections available.

CONTACT NUMBER “CUT” FORMAT MENU SELECTION “7-6”			
Number (Standard Morse)		Number (Cut Morse)	
0	-----	“T”	—*
1	•-----	“A”	•—
2	••-----	“U”	••—
3	•••-----	“V”	•••—
5	•••••	“E”	•
7	---•••	“B”	—•••
8	----••	“D”	—••
9	-----•	“N”	—•
* The standard Morse zero (0) can alternately be sent as “O” (----).			
4-Digit Contest Number Format			
Default	Truncated	Disabled	N/A
XXXX	XXX	OFF	N/A

To select between three-digit contest numbers (e.g. “599001”) and four digit contest numbers (e.g. “5991234”), select *menu selection 7-6*, then rotate the Sub Dial to the final selection, which is the number of playback digits. Select the desired number of digits, then press [ENT] to save the setting and exit. Note that, if you begin with a three-digit contest number, the **MARK-V FT-1000MP Field** will automatically switch over to four-digit numbering after QSO #999, so it generally is best to select three-digit numbering.

2. CQ or ID Memory

The [ID] key allows storage and recall of any message of up to 20 characters in length. Because of the convenient location of [ID] key on the **FH-1** Remote Control Keypad option, this memory location is most ideally suitable for your main “CQ TEST” message or for your callsign (for one-touch use in a pile-up, for example).

3. User Message Memories 1 - 4

Keys [CH 1] ~ [CH 4] allow storage and recall of messages of up to 50 characters in length. These memory locations are more suitable for longer messages which cannot be programmed into the “Contest Number” or “ID” memory locations.

4. Message Storage

The [STO] key is used in the message memorization process. Push [STO] followed by one of the message playback keys ([#], [ID], or [CH 1] ~ [CH 4]), then send (on your keyer paddle) the message to be stored, then press the [STO] key to terminate the memory storage process.

5. Message Monitor

(Playback without Transmitting)

The [MONI] key may be used to review the contents of a memory location, or to determine the next-to-be-used contest number, without transmitting the message over the air.

To use this feature, the [MONI] key on the front panel of the transceiver must be turned off. The reason for this is that the [MONI] key activates the RF keying monitor, which requires a transmitted signal in order to function.

To check the contents of the “ID” memory slot, for example, press [MONI] then [ID]. You will hear the message which currently is stored in the “ID” slot in the speaker or headphones. To check to see what the next-to-be-sent contest number is (in case you’ve forgotten, etc.), press [MONI] then [#]. The contents of the “#” memory slot will be played (e.g. “599388 BK”), and the contest number will not increment after play-

REMOTE CONTROL OPERATION

back in this mode; the contest number only increments if the message is sent over the air.

Remember, if pressing the **[MONI]** key, then a memory playback key, has no effect, you probably have the **[MONI]** button pushed in. De-activate the RF keying monitor to allow yourself to hear the stored message.

6. Tune Mode

Pressing the **[TUNE]** key activates a transmitted carrier for as long as the key is held in; this is useful for adjustment of a linear amplifier or external antenna tuner, or for antenna performance comparisons over the air.

The power output level to be used for tuning is programmable via *menu selection 4-3*. In this Menu selection, maximum power output levels of 10W, 25W, or 100W may be chosen. The front panel **RF PWR** control allows adjustment of the power level up to the maximum power output selected via *menu selection 4-3*.

Contest Keyer Operation

Programming of the six available message storage locations is accomplished by a simple keyed and keyer paddle input sequence. Only Iambic (not “Bug”) keying can be used for storage of CW messages, and we recommend that *menu selection 7-0* be set to “Iambic 2” during message storage, although you may prefer to use “Iambic 1” during manual sending once the desired messages are stored.

Example: Program “CQ TEST DX1DX DX1DX” into the “ID” Memory Slot.

- Be sure that the **FH-1** (or your home-built) keypad is plugged into the rear panel **REMOTE** jack.
- Press the **[STO]** key, followed by **[ID]**. This selects the “ID” memory as the memory location to be utilized.
- Using your keyer paddle, send “CQ TEST DX1DX DX1DX” followed by another press of key **[STO]** to end the storage process for this memory location. Be careful to pause slightly after each word so as to leave a word space in the message string.
- To play back the message memory without transmitting, press the **[MONI]** key followed next by **[ID]**. If you don’t hear anything, check to be sure that the “**MONI**” LED on the bottom-left-hand edge of the BOWMAN front panel is not illuminated.
- To transmit the CQ message, just press **[ID]**.

Message memories 1 ~ 4 (keys **[CH 1]** ~ **[CH 4]**) are programmed, played back, and transmitted in the same manner; however, you can enter up to 50 characters in each of these. Particularly if you have a long callsign, you may wish to use key **[ID]** for storage of

just your callsign, then use message memories 1 ~ 4 (keys **[CH 1]** ~ **[CH 4]**) for your “CQ Contest” messages.

Note also that if you want to send a message multiple times, you can press the playback key more than once; at the end of the first message segment, the message will restart and be sent again. This is useful if you want to call “CQ” while getting a drink from the refrigerator.

You may then send a “K” manually when the automatic message generation is completed after the desired number of repeats.

Example: Program “599001 BK” as an initial contest number (to be incremented after each QSO):

- Following the procedure described above, press the **[STO]** key then the **[#]** key.
- Now send the contest exchange, but send “???” at the point in the message where you want the number to appear. In this example, send “599???” then press **[STO]** to terminate the entry. To send “5NN001 BK” (“N” replacing “9”), modify your sending accordingly (the number-cutting protocol in *menu selection 7-6* only affects numbers sent within the “???” area). If you want to separate the signal report and the contest number, send “5NN ??? BK” (add a word space between the report and the question marks).
- To play back the just-stored message without transmitting, and without causing the contest number to increment automatically, press the **[MONI]** key followed by **[#]** key. You may do this as many times as you want and the contest number will stay the same. If you transmit the message by pressing the **[#]** key alone, however, the contest number will automatically increment, and another press of the **[#]** key will cause “599002 BK” to be sent (followed by “599003 BK” the following time, and so forth).
- If the other station asks for a repeat of your contest exchange, remember that the number will have incremented automatically after you sent it. Press the **[DWN]** key to return to the previous number, then press **[#]** key to repeat the exchange for the other station. If you need to increment the number manually for some reason, the **[#UP]** key may be used in the same manner.
- If, for some reason, the contest number generated via **[#]** key is significantly different from the desired number, it may be reset via *menu selection 7-3*. From this menu selection, you may set the next-to-be-used contest number to any value between 0000 and 9999 by rotating the Main Dial; press **[ENT]** to save the new setting and exit.

REMOTE CONTROL OPERATION

II. VFO/MEMORY CONTROL

Menu selection 7-9 also allows utilization of the Remote Control Keypad for VFO and Memory control. The front panel [VFO/MEM], [A ▶ B], [A ▶ B], [M ▶ A], [M CK], [A ▶ M], [RCL], [STO] and [DUAL] keys are duplicated on the Remote Control Keypad.

III. MAIN VFO-A CONTROL

Selection of this mode via *menu selection 7-9* duplicates the action of the 12-key front panel **BAND** keypad on the front panel of the **MARK-V FT-1000MP Field**. Direct frequency entry and one-touch band change are possible on both the Main and Sub VFOs, exactly as on the front panel keypad.

IV. SUB VFO-B CONTROL

This function is essentially identical to "Main VFO-A Control" as described above. However, when the [ENT] key is pushed to begin direct frequency entry, the frequency input will be applied to the Sub VFO-B register, not the Main VFO-A register. This allows the operator to use the transceiver's front panel keypad for the Main VFO, and the remote keypad for the Sub VFO, thus reducing the required keystrokes by one.

Note that, in the Sub VFO-B Control mode, pushing [SUB(CE)] then [ENT] does not shift frequency entry control to the Main VFO-A (which is the "sub" VFO of Sub VFO-B). In this mode, frequency can only be applied to the Sub VFO-B; there is no direct frequency entry pathway to Main VFO-A.

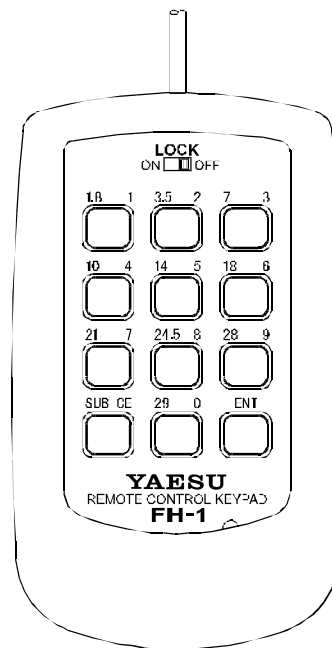

Advanced Features

USER-CUSTOMIZED OPERATING MODE

OVERVIEW

This mode recalls a pre-configured operating “environment” (mode, filter selections, offsets, etc.) by *pressing and holding* in the [PKT] key on the front panel.

This can be useful for storing your favorite combination of operational settings for a mode you often use. Digital operators who go through the various procedures of combining filter selections, carrier and display offsets, etc., for a custom environment optimized for FAX or SSTV (as an example) can store these settings for easy recall. For special modes that require unique configuration of transceiver settings that are not used elsewhere, the “USER” mode comes in handy for storing these parameters while keeping other transceiver settings default for general operation.

The following parameters are user-customized by recalling *menu selection 8-6*. Operating parameters are chosen by turning the SUB VFO-B tuning knob, while parameter settings are changed with the MAIN VFO-A knob (see below).

CUSTOM USER-MODE SETTINGS MENU SELECTION “8-6”		
Selected with:		Comments:
Sub VFO B Dial	Main VFO A Dial	
MODE	LSB, USB, CW (USB), CW (LSB), RTTY (LSB), RTTY (USB), PACKET (LSB)	Select the operating situation to which the custom setting will be applied.
DISPLAY OFFSET	±5.000 kHz	※1
RX PLL	±5.000 kHz	※1
RX CARRIER	450 - 460 kHz	※1
TX PLL	±5.000 kHz	※1
TX CARRIER	450 - 460 kHz	※1
RTTY OFFSET	±5.000 kHz	※1
EASY SET	OFF, SSTV (LSB), SSTV (USB), PACKET (LSB), PACKET (USB), FAX (LSB), FAX (USB), PSK-31 (LSB), PSK-31 (USB)	※2
※1: The tables on pages 106, 107, and 110 list various menu selected receive and display offsets for each mode. ※2: Settings are factory preset & non-adjustable.		

Mode - Select from LSB, USB, CW (upper or lower), RTTY (upper or lower), or Packet (AFSK, LSB default).

Display Offset - Choose a custom offset ±5.000 kHz (in 5-Hz steps) to be displayed when the “USER” mode is active.

Rx and Tx PLL Offset - Choose a custom PLL offset ±5.000 kHz (in 5-Hz steps) to take effect when the “USER” mode is active.

Rx and Tx Carrier - Changes the carrier injection frequency between 450-460 kHz.

RTTY Custom Shift - Choose a custom (non-standard) RTTY shift of ±5.000 kHz (in 5-Hz steps) when the “User” mode is active.

“Easy Set” - this allows choosing one of two factory-configured settings optimized for either SSTV (slow scan television) or FAX (facsimile) operation.

With the user settings customized as desired, *press and hold* in the [PKT] key (its red LED blinks for three seconds when activated) to recall the “User” mode. The custom settings will take effect, and the display changes to reflect the new operating mode. To exit the “User” Mode, simply press any band, mode or function key so the red LED in the [PKT] key turns off.

Note: see pages 106 and 107 for a complete listing of default settings according to operating mode.

Important!

While the “USER” Mode allows customizing operation for various operating environments, changing some settings (especially the PLL offset and carrier injection) can adversely affect transceiver operation. Before making any “USER” Mode adjustments, ensure you have a firm understanding on how changing these affect transceiver operation and frequency display. If you are not sure, we recommend leaving them as set (to their default values shown in the table).

You can return all transceiver settings (menu selections) to their default values at any time by performing a CPU reset. Simply hold the [SUB(CE)], [29(0)], & [ENT] keys together while turning the transceiver on.

OPTIONAL DVS-2 DIGITAL VOICE RECORDER

OVERVIEW

The **DVS-2** is a digital voice recorder designed especially for SSB, AM, and FM operation with newer model Yaesu transceivers having a special jack for connection of the **DVS-2** on the rear panel. It offers two independent functions:

- ❑ Recording received signals for playback later in the loudspeaker or headphone;
- ❑ Recording signals, using the microphone, for playback over the air (during transmission).

Each mode uses its own memory, so both modes can be used to retain data at the same time. Operating details are provided with the **DVS-2**, but a summary is provided here.

INSTALLATION

Connect the **DVS-2** cable to the **DVS-2** jack on the rear of the transceiver. You must also have a microphone connected to the **MIC** jack on the front panel of the transceiver to record your voice for transmissions.

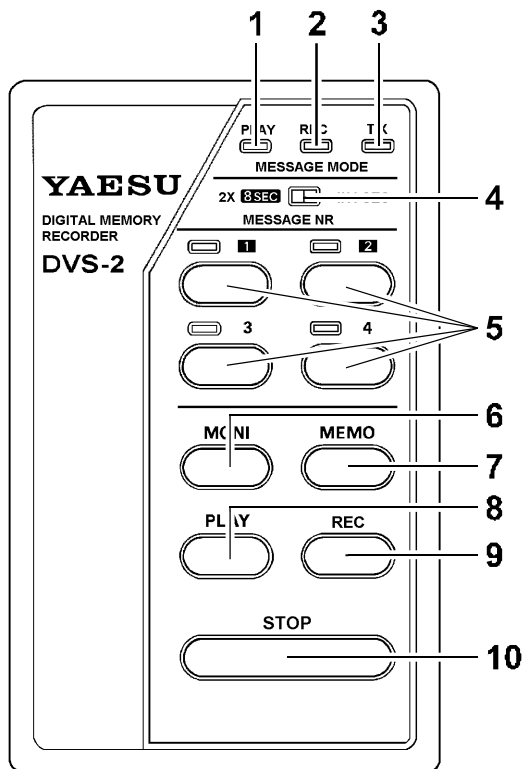

DVS-2 Controls

(1), (2), & (3): PLAY, REC & TX LEDs

These LEDs light or flash to indicate the status of the **DVS-2**. The “**PLAY**” LED glows green when playing back stored data, the “**REC**” LED glows yellow when recording, and the “**TX**” LED glows red when the **DVS-2** is keying the transmitter to play back over the air. Also, the “**PLAY**” and “**REC**” LEDs flash when waiting for you to make a memory selection (with a numbered button).

(4) MESSAGE MODE Slide Switch

This selects the mode for recording messages to be played back over the air: for either two 8-second messages, or four 4-second messages. Changing your selection does not erase previously stored messages, so you can use this switch to combine two pairs of 4-second messages.

(5) MESSAGE NR Selection Buttons & LEDs

These buttons select which message slot to record via the microphone or play back over the air. The LED above each button glows red when a message has been stored in that slot. The [3] and [4] keys (and LEDs) are only functional when the **MESSAGE MODE** switch is set to the [4 x 4 SEC] position.

(6) MONI Button

After recording a message via the microphone, press this button (followed by a message number button) to play back that message in the loudspeaker (instead of over the air).

(7) MEMO Button

Press this button (followed by a message number button) to record a message via the microphone.

(8) PLAY Button

After recording received signals, press this button to play them back in the transceiver’s loudspeaker.

(9) REC Button

Press this button to start the receiver recorder. The recorder will run continuously (recording an 16-second loop) until you press the [STOP] button.

(10) STOP Button

Press this button to stop any recording or playback operation.

Advanced Features

OPTIONAL DVS-2 DIGITAL VOICE RECORDER

MESSAGE RECORDING

(FROM MAIN OR SUB RECEIVER AUDIO)

When used in this mode, the **DVS-2** maintains a continuous recording of the last (approximately) 16 seconds of audio from either the main or sub-receiver. This can be particularly helpful in picking out callsigns during a pileup, as you can replay the same recording as often as you like (until you record over it). The record/playback process in this mode is analogous to an 16-second "endless tape" - that is, you can turn the recorder on and off to record up to a total of 16 seconds of small segments of audio, or you can leave the recorder running to get one 16-second segment. In any case, the recorder overwrites data more than 16 (recording) seconds old.

- To start the receiver recorder, just press the **[REC]** button. The yellow "**REC**" LED will light (and stay lit).
- When you hear something you want to play back, press the **[STOP]** button (the "**REC**" LED will turn off), and then press the **[PLAY]** button. Now the green "**PLAY**" LED will light as recorded audio is played back through the main receiver audio channel.

Note that if you record for less than 16 seconds, playback will start at the point you first started recording (no "rewind" necessary). However, if you record for more than 16 seconds, playback will begin at the point 16 seconds before you stopped recording. In either case, playback will repeat any recorded audio every 16 seconds.

To stop the playback at any time, simply press **[STOP]**. If you then press **[PLAY]** again, playback will continue from the point you stopped it.

PLAYBACK

(ON THE AIR OF RECORDED RECEIVER AUDIO)

Once you have recorded an incoming transmission from another station, you can play it back to them by pressing the **[PLAY]** button on the **DVS-2**, followed immediately by the **MOX** switch on the front panel of the **MARK-V FT-1000MP Field**. This can be handy if you wish to advise another station of an anomalous signal condition, for example.

Note: Communications-privacy regulations may require you not to divulge the results of a prior contact (or a receiving session) to a third party. Consult the regulations for your country to ensure full compliance with your country's regulations.

MESSAGE RECORDING

(FROM MICROPHONE AUDIO)

This mode allows the **DVS-2** to record either two 8-second messages or four 4-second messages of audio from the microphone, such as contest exchanges or station IDs. Each can then be played back, either in monitor mode (without transmission), or directly over the air. Note that the digital memory used in this mode is independent from that used for receiver recording (so you can store both types of memory without interfering with one another).

The 8- and 4-second messages share the same memory, so two 4-second message segments (1 and 2 or 3 and 4) can be combined into one 8-second message for transmission, as indicated in the following table.

MEMORY SEGMENTS & MESSAGE NUMBERS		
Button Pressed	Segment(s) Used in Record/Playback	
	2 x 8-second Message Mode	4 x 4-second Message Mode
1	Segments 1 & 2	Segment 1
2	Segments 3 & 4	Segment 2
3	No Function	Segment 3
4	No Function	Segment 4

Before you record for transmission, check that the **[MESSAGE MODE]** Switch is set for the size message you want to record, either 4-second or 8-second (see the table above and the Example in the next section for help with this decision). You do not need to press the **PTT** switch while recording a message, although you can, in which case your audio will be transmitted and recorded simultaneously.

OPTIONAL DVS-2 DIGITAL VOICE RECORDER

- ❑ Get your microphone ready, and then press the [MEMO] button (the yellow "REC" LED will blink).
- ❑ Now press the numbered key for the segment (or segment pair) to record (only [1] or [2] for the 8-second mode), and start talking (do not press the PTT switch unless you want to transmit at the same time you are recording).

The "REC" LED will stop blinking and stay on for the recording period (4 or 8 seconds), and then turn off. Also, the red LED above the numbered key you pressed will come on (if this segment was previously empty) and stay on, indicating this segment is now storing data.

To stop recording at any point before the selected segment's time limit is up, simply press STOP.

This is the preferred method, since it eliminates any "dead time" remaining from your last-recorded word and end of the time segment (which would keep your transmitter unnecessarily keyed for a short period). In any case, your message can not exceed the 4- or 8-second limit.

Don't worry if you didn't have enough time to finish your phrase, you can repeat the above steps to re-record the same message - the previous message will be overwritten (note that there is no "rewind" step required).

MESSAGE MONITOR

(PLAYBACK WITHOUT TRANSMITTING)

You can check the contents of a memory segment or pair without playing it back over the air, just by pressing [MONI] followed by the appropriate numbered key.

The green "REC" LED blinks until you press the numbered key, and then stays on during the playback period. We recommend always using this to check the results immediately after making a recording and before playing it back over the air. If you have recorded several 4-second segments that you intend to combine during playback, move the MESSAGE MODE switch to the [2 x 8 SEC] position to hear how the segments sound when played back together. Note from the table on the preceding page that, in the 8-second mode, the [1] button plays back segments 1 and 2, while the [2] button plays back segments 3 and 4.

MESSAGE TRANSMISSION

("ON THE AIR" PLAYBACK)

After recording a memory segment, you can play it back over the air by pressing the appropriate numbered button. The green "PLAY" and red "TX" LEDs will both light for a maximum of either four or eight seconds, according to the setting of the MESSAGE MODE switch.

Note! Normally, pressing a numbered message key on the DVS-2 activates the MARK-V FT-1000MP *Field* transmitter and sends the recorded message. If you would like to disable PTT control from the DVS-2, recall *menu selection 4-7* and change the setting to "OFF." Now, transmission is only possible using the microphone PTT or MOX switches.

Receiver Recording with the MARK-V FT-1000MP *Field*

As the DVS-2 uses only one receiver audio channel of the MARK-V FT-1000MP *Field*, you can play back recordings without missing real-time action by pressing [A ► B] to set the two VFOs to the same frequency.

With stereo headphones, this allows you to continually monitor signals on the sub VFO audio channel while playing back a recording on the main channel.

Selecting Receiver Audio

As mentioned earlier, the DVS-2 can record audio from either the Main or Sub receiver. To choose the desired receiver, recall *memory selection 4-6* and pick either MAIN VFO or SUB VFO as the default receiver.

Advanced Features

PHONE PATCH OPERATION

OVERVIEW

Phone patch operation allows linking your **MARK-V FT-1000MP Field** to the public telephone line to provide two-way simplex communications for MARS operation, or on behalf of a third parties. The **MARK-V FT-1000MP Field** may be used with the **LL-7** phone patch unit installed in the optional **SP-8** external loudspeaker, or with phone patch units from other manufacturers. The diagram at the bottom of the page shows interconnection for the **SP-8/LL-7** combination; be sure to consult the documentation provided with units of other manufacture for installation instructions.

OPERATION

Phone patch Tx/Rx switching may be done manually using the PTT method, or automatically using the VOX circuit of the transceiver. While the PTT method does not require balancing the bridge circuit in the **LL-7**, it does require more work by the operator: switching the microphone **PTT** or transceiver **MOX** button at each "over" during patched conversations. Therefore, most operators prefer to use the VOX method whenever the telephone signal-to-noise level permits. If the telephone noise level is high, however, the PTT method may still be necessary, so you should become familiar with both methods.

Regardless of which patch control method is used, you may need to instruct the person on the telephone to speak slowly at a clear normal voice, and to say "over" and then keep quiet when they expect a response from the other radio station. This serves as a notice to you (if you are using PTT control) to switch to receive while signaling the other station to go ahead and transmit, and will help avoid "doubling" with the other station.

During all phone patch operation you should monitor both sides of the conversation at all times (this may be required by law). This requires a telephone at the operating position.

Refer to the **LL-7** Instruction Sheet for further details on phone patch setup and operation.

Note

You may need to contact your telephone company for permission to connect another device to the phone circuit. Also, you should use a proper 600 Ohm, three-way transformer if connecting the **LL-7** with a telephone set to the same phone line.

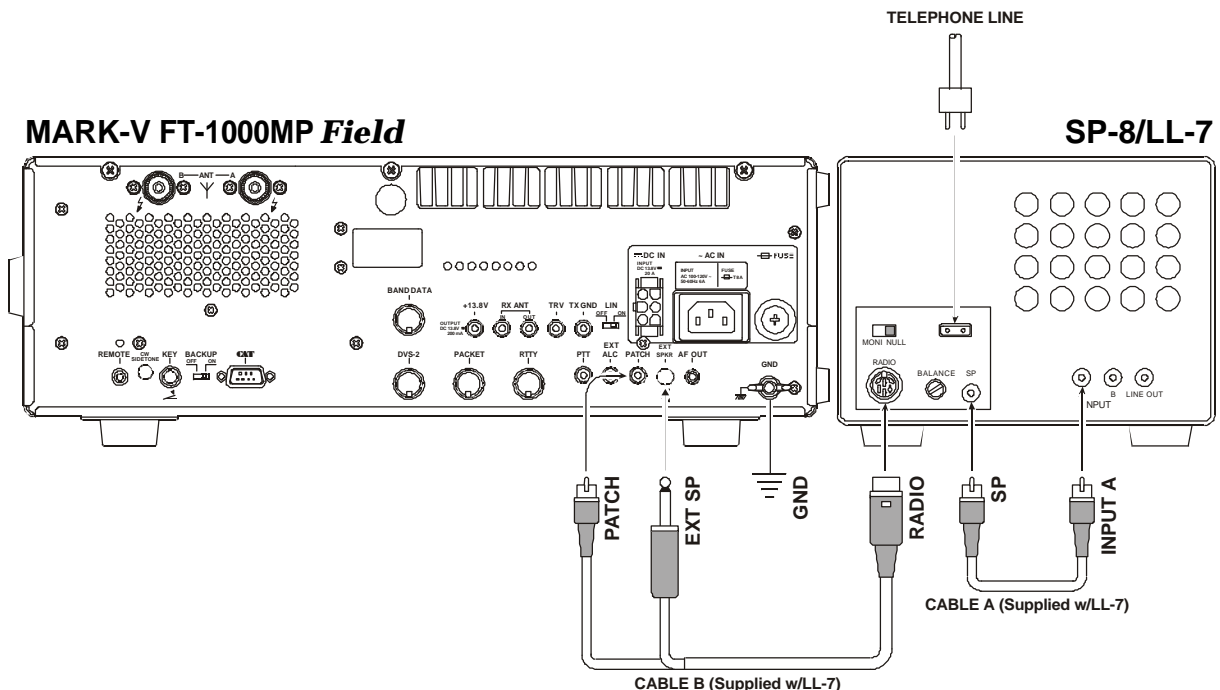

TUNING METER RE-CALIBRATION

The multi-function meter offers either flashing single or dual segments to indicate properly tuned CW or FSK (RTTY/PKT) stations. An explanation of tuning indications is on page 42.

CW TUNING

From the factory, the single CW tuning segment is calibrated (centered) for the default CW Pitch setting of 700 Hz. If you change the CW Pitch (page 56) to other than 700 Hz, you should re-calibrate the meter so that station center-tuning will match the new CW Pitch. Calibration is a simple process, and only requires a small Phillips screwdriver:

CW Tuning Meter Calibration

(after CW Pitch adjustment)

- ❑ Open the access panel on the transceiver top case to expose the ALC Unit.
- ❑ After setting the desired CW Pitch, press the [SPOT] button to toggle the CW spot tone (which matches the CW Pitch) on. Use a small screwdriver to slowly turn **CW** control in the top access panel so the center meter tuning segment turns on.
- ❑ This completes the calibration for CW tuning; replace the panel, and turn off the spot tone.

RTTY TUNING

RTTY tuning segments are calibrated (centered) for default 170-Hz shift, using a mark/space pair of 2125/2295 Hz. If you change the default RTTY shift (*menu selection 6-0*) to other than 170 Hz, you should re-calibrate the meter so that mark/space tuning segments match the new tone pair:

RTTY Tuning Meter Calibration

(after changing RTTY Shift)

- ❑ Open the access panel on the transceiver top case to expose the ALC Unit.
- ❑ After setting the desired RTTY shift, recall *menu selection 4-2*, and select “*bEEP-tun*” using the **SUB VFO-B** tuning knob.
- ❑ Rotate the **MAIN VFO-A** knob to display (and oscillate) the center frequency of the mark/space tone pair for the shift you are using (170 Hz = 2210 Hz, 425 Hz = 2125 Hz, 850 Hz = 2550 Hz).
- ❑ Use a small screwdriver to slowly turn **RTTY** control in the top access panel so the center meter tuning segment turns on.

This completes the RTTY calibration, replace the panel, and turn off the beep tone.

PACKET TUNING

The dual packet tuning segments are calibrated (centered) to the default 200-Hz shift tones used for 300-baud HF packet. These tones use a mark/space pair of 2025/2225 Hz. If you change the default PKT tones (*menu selection 6-5*) to other than 2025/2225 Hz, you should re-calibrate the meter so that mark/space tuning segments will match the new tone pair:

PKT Tuning Meter Calibration

(after changing PKT Tones)

- ❑ Open the access panel on the transceiver top case to expose the ALC Unit.
- ❑ After selecting the desired tone pair, recall *menu selection 4-2*, and select “*bEEP-tun*” using the **SUB VFO-B** knob.
- ❑ Rotate the **MAIN VFO-A** knob to display (and oscillate) the center frequency of the mark/space tone pair you are using (1170 Hz, 1700 Hz, 2125 Hz, 2210 Hz - see page 58).
- ❑ Use a small screwdriver to slowly turn **PKT** control in the top access panel so the center meter tuning segment turns on.

This completes the PKT calibration, replace the panel, and turn off the beep tone.

Caution!

Do not adjust **VR6812** control in the top access panel by mistake, as this will adversely affect meter tuning indication, requiring factory re-alignment!

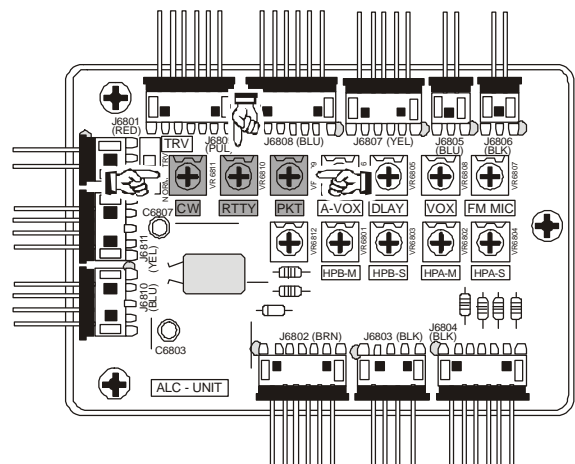

Meter Calibration Points (Top Panel Access)

CAT System Computer Control

OVERVIEW

The **CAT** (Computer Aided Transceiver) System in the **MARK-V FT-1000MP Field** provides control of frequency, VFO, memory, and other settings such as dual-channel memories and diversity reception using an external personal computer. This allows multiple control operations to be fully automated as single mouse clicks or keystroke operations on the computer keyboard.

The **MARK-V FT-1000MP Field** has a built-in level converter, allowing direct connection from the rear-panel **CAT** jack to the serial port of your computer without the need of any external boxes.

Each time a command instruction is being received from the computer via the **CAT** port, the "**CAT**" indicator appears in the display, then turns off afterward. You will need a serial cable for connection to the RS-232C (serial or COM port) connector on your computer. Purchase a standard serial cable (not the so-called "null modem" type), ensuring it has the correct gender and number of pins (some serial COM port connectors use a 9-pin rather than 25-pin configuration). If your computer uses a custom connector, you may have to construct the cable. In this case, refer to the technical documentation supplied with your computer for correct data connection.

Vertex Standard does not produce **CAT** System operating software due to the wide variety of personal computers and operating systems in use today. However, the information provided in this chapter explains the serial data structure and opcodes used by the **CAT** system. This information, along with the short programming examples, is intended to help you start writing programs on your own. As you become more familiar with **CAT** operation, you can customize programs later on for your operating needs and discover the true operating potential of this system.

CAT DATA PROTOCOL

Serial data is passed via the **CAT** jack on the rear panel of the transceiver at 4800 bits/sec. All commands sent from the computer to the transceiver consist of five-byte blocks, with up to 200 ms between each byte. The last byte sent in each block is the instruction opcode, while the first four bytes of each block are arguments: either parameters for that instruction, or dummy values (required to pad the block out to five bytes):

CAT 5-BYTE COMMAND STRUCTURE				
Byte 1	Byte 2	Byte 3	Byte 4	Byte 5
Argument	Argument	Argument	Argument	Instruction OPCODE

Each byte sent consists of one start bit, 8 data bits, no parity bit and two stop bits:

CAT DATA BYTE FORMAT										
Start Bit	0	B	1	1	1	1	1	1	Stop Bit	Stop Bit

There are twenty-nine instruction opcodes for the **MARK-V FT-1000MP Field**, listed in the table on pages 94 ~ 97. Most of these duplicate menu programming settings or options, or else emulate front panel button functions. Notice that several instructions require no specific parameters. However, every Command Block sent to the transceiver must always consist of five bytes.

The **CAT** control program you are writing must construct the 5-byte block, by selecting the appropriate instruction opcode, organizing the parameters, if any, and providing unused (dummy) argument bytes for padding the block to its required 5-byte length (the dummy bytes can contain any value). The resulting five bytes are then sent, opcode last, from the computer to the **MARK-V FT-1000MP Field** CPU via the serial port and **CAT** jack on the transceiver rear panel.

CONSTRUCTING AND SENDING CAT COMMANDS

Example #1: Set Main VFO-A to 14.25000 MHz;

- ❑ First determine the opcode for the desired instruction by referring to the **CAT** Commands Table. A good idea would be to store these opcodes within the program, so they can be looked up when the user requests the corresponding command.
- ❑ Here the instruction is “Set Main VFO Frequency,” so the opcode (last byte of the block) is **0AH**.
Note - “H” s following each byte value indicate hexadecimal (base 16) values.
- ❑ Build the four argument byte values from the desired frequency by breaking it into 2-digit blocks (BCD “packed decimal” format). Note that a leading zero is always required in the hundreds-of-MHz place (and another in the tens-of-MHz if below 10 MHz).
- ❑ Breaking 14.250.00 MHz into its BCD component, we arrive at:

10's Hz	100's Hz	1's kHz	10's kHz	100's kHz	1's MHz	10's MHz	100's MHz
0	0	0	5	2	4	1	0
00		50		42		01	
Byte 1		Byte 2		Byte 3		Byte 4	

- ❑ Inserting the 4-byte BCD-coded frequency (00, 50, 42, 01), the resulting 5-byte block should now look like this (again, in hex format):

Byte 1	Byte 2	Byte 3	Byte 4	Byte 5
00	50	42	01	0AH
DATA/ARGUMENT BYTES				OPCODE

- ❑ Send these five bytes to the transceiver, in the order shown in the table above - from left-to-right: **00 50 42 01 0AH**.

Example #2: Activate a RX Clarifier Offset of +3.5 kHz.

- ❑ Clarifier settings are controlled from opcode **09H**. The first four parameter bytes determine the type of offset, direction, and frequency displacement.
- ❑ According to the example, the first byte would be **50** (500 Hz), the second **03** (3000Hz), followed by **00H** (for +offset), **81H** (TX CLAR on) and then opcode **09H**. Remember that the 1st and 2nd bytes are in BCD format.
- ❑ Completing the command byte sequence, we would send, in sequence, **50H, 03H, 00H, 81H, 09H**, to effect the Tx Clarifier offset.

Byte 1	Byte 2	Byte 3	Byte 4	Byte 5
50H	03H	00H	81H	09H
DATA/ARGUMENT BYTES				OPCODE

You should be getting a feel for the **CAT** command structuring sequence, let's move to the next step; reading transceiver operational data.

CAT System Computer Control

DOWNLOADING

MARK-V FT-1000MP *Field* DATA

On command, the **MARK-V FT-1000MP *Field*** will download some or all (1,863 bytes) of its operational data. This data block contains all current transceiver settings. In addition, the current meter indication (Tx or Rx) is read, digitized and returned as well. This provides a wealth of information in near real-time that can be processed by your program or the running application for control purposes or display readouts. By regular or intermittent requests for this data, the program (and you) can be kept continuously up-to-date on the status of the **MARK-V FT-1000MP *Field*** operating environment.

The following four commands cause the **MARK-V FT-1000MP *Field*** to download various operational and internally stored settings via the **CAT** port:

Status Update (10H) - causes the transceiver to return all or portions of its RAM table (up to 1,863 bytes).

Status Flags Request (FAH) - obtains only the first 6 bytes (the Status Flags), plus 2 extra "Model ID" bytes (10H and 00H).

Read Meter (F7H) - returns the meter deflection (0 - FFH) repeated in four bytes, followed by one "filler" byte (F7H).

Pacing Command (0EH) - Each byte of returned data may be delayed by an interval determined by this command (0 to 255 ms in 1-ms steps). This delay is initially zero until the Pacing command is sent (see note below).

Note: Pacing allows returned data to be read and processed by slower computers. However, set it as short as your computer will allow, to minimize the inconvenience of the delay. Sending all 1,863 bytes requires just under 5 seconds with zero-length delay selected, but over 5 minutes if the maximum delay is selected!

Parameter	Bytes Returned	Data Returned	Comment
U = 00H	1,863	All Status Update Data	See above Box - <i>Pacing Command</i>
U = 01H	1	Memory Channel No.	Current or Last Selected Memory
U = 02H	16	Current Operating Data (VFO or Memory)	See the Tables on page 91 and 92 for 16-byte data record structures
U = 03H	32 (2 x 16)	Main VFO-A & Sub VFO-B Data	
U = 04H*	16	Memory Data	
X = 00 ~ 71H	NA	X = Memory (1-99, P1 ~ P5, Q1 ~ Q5) * only used when U = 04H	

STATUS UPDATE DATA ORGANIZATION

An overview of the Status Update Data that can be returned to the PC in response to one of the Status Update requests (opcodes 10H, FAH, F7H, or 0EH) is shown next page. The 1,863-byte block begins with six bytes, each containing one-bit state Status Flags (A), for a total of 48 bits, followed by one byte indicating the current (or last selected) Memory Channel (B), followed by 116 x 16-byte data records: one for the current Operating Data (C), one each for VFO-A (D) and VFO-B (E), and one for each of the 113 memories (F).

Of the four commands that cause Status Update to be returned, remember that only opcode 10H (with its last argument set to zero) returns all of the data (see bottom left of this page).

STATUS FLAGS (BYTES 1~ 6)

Each of the first six bytes are subdivided into 1-bit flag fields: if a bit is set (1), the function is enabled (on); and if reset (0), the function is disabled (off). These flags reflect the current states of various transceiver functions, most of which appear in the radio display as indicators or LEDs. The Status Flags command returns these bytes for use in the control program (you could replicate these indicators on the computer display, or else use them as control flags for routines, etc.). Bit offsets for all six bytes is shown on page 89.

MEMORY CHANNEL DATA (BYTE 7)

The seventh Update Data Byte contains a binary value from 00 ~ 70H, corresponding to the current memory channel number on the display. Only this byte is returned by sending the Status Update command with the first parameter set to 1. The chart on page 90 lists the corresponding hexadecimal codes for memory channels 01 ~ 99, P1 ~ P9, and QMB memories 1 ~ 5.

16-BYTE DATA RECORDS (BYTES 8 ~ 1863)

The remainder of the operational data returned by the Status Update command consist of 16-byte data records, indicating VFO and memory-specific selections. The first of these records is for the current display, followed by the VFO-A, VFO-B, and then the 113 memory channels, from lowest to highest. Please review the table at the top left column on page 91, which outlines the structure of a 16-byte data record. Each byte is identified by its offset from the start (base address) of the record. A further breakdown of each byte offset is also provided.

Note that this same 16-byte data record format is used for the VFO and Memory Data as well, unless you are currently operating on a retuned memory ("M TUNE" displayed).

CAT System Computer Control

STATUS UPDATE DATA ORGANIZATION

1863-Byte Status Update Data (sent L-to-R)

Status Flags	Memory Channel No.	Operating Data	VFO-A Data	VFO-B Data	Memory Data
6 byte (A)	1 byte (B)	16 byte (C)	16 byte (D)	16 byte (E)	16 bytes (x 113 memories = 1808 bytes total) (F)

6-Byte Status Flags Record Table

Bit Offset	STATUS FLAG BYTE #1 CONTENTS
0	Split Frequency Operation
1	Dual Receive Operation
2	Antenna Tuning In Progress
3	CAT System Activated
4	SUB VFO-B In-Use (Rx/Tx LED on)
5	Keypad Entry In Progress
6	Main Receiver Muted
7	PTT Keyed (Tx Active)

Bit Offset	STATUS FLAG BYTE #4 CONTENTS
0	2nd IF 455 kHz Filter Selection Active
1	1st IF 8.2 MHz Filter Selection Active
2	N/A
3	N/A
4	PTT Keyed via CAT Command
5	General Coverage TX Inhibit
6	Key Release Timer Active
7	Tx Inhibit

Bit Offset	STATUS FLAG BYTE #2 CONTENTS
0	5-sec. MEM CHK Timer Active
1	Memory Checking In Progress
2	Dual VFO Tracking Active
3	Quick Memory Bank Selected
4	Memory Tuning Active
5	VFO Operation
6	Memory Operation
7	General Coverage Reception

Bit Offset	STATUS FLAG BYTE #5 CONTENTS
0	RTTY TX Idle
1	N/A
2	N/A
3	Grouped Memory Mode Active
4	ANT B Selected
5	RX ANT Selected
6	PMS Tuning Active
7	AM Synchronous Mode Active

Bit Offset	STATUS FLAG BYTE #3 CONTENTS
0	FAST Tuning Active
1	Antenna Tuner (ATU) In-Line
2	SUB VFO-B Locked
3	MAIN VFO-A Locked
4	Squelch Closed
5	Scan Direction (Up/Down)
6	Scan Paused
7	Auto Memory Write Scanning Active

Bit Offset	STATUS FLAG BYTE #6 CONTENTS
0	Sub Receiver Audio Muted
1	Main Receiver Audio Muted
2	Dual VFO Tracking
3	N/A
4	N/A
5	VFO Channel Stepping
6	Tuner Wait (while tuning)
7	AM Synchronous Mode Active

CAT System Computer Control

SELECTING UPDATE DATA TO DOWNLOAD

As mentioned before, there are four opcodes that cause the **MARK-V FT-1000MP Field** to report (update) its operating status by downloading all or a portion of its 1,863 data bytes. These opcodes are shaded in the **CAT** Commands table (pages 94 ~ 97).

Status Update (Opcode **10H**) - The 1st and 4th parameters of this command allow selecting different portions of Status data to be returned, as follows ("X" is the 1st parameter, "U" is the 4th):

Read Flags (Opcode **FAH**) - This command can be set to retrieve all six Status Flag bytes, or else five bytes - three Status Flag Bytes, plus two transceiver ID bytes. The Status Flag Bytes are described on the preceding page, and in the Record Tables on the previous page.

The transceiver ID bytes are used in programs to distinguish the **MARK-V FT-1000MP Field** from other models, which have different, unique values returned in this situation. The constant values of **03H** and **93H** are returned by the **MARK-V FT-1000MP Field** (and only the **MARK-V FT-1000MP Field**), as shown:

Flag Byte	Flag Byte	Flag Byte	ID Byte 1	ID Byte 2
1	2	3	(03H)	(93H)

Read Meter Data (Opcode **F7H**) - Sending this command returns a digitized meter deflection indication, between **00** and **FFH** (usually around **F0H** maximum). Four copies of this value are returned, along with one padding byte (**F7H**), as follows:

Meter Byte	Meter Byte	Meter Byte	Meter Byte	F7H

During reception, the signal strength deflection is returned. During transmission, the parameter represented by the reading returned depends on the setting of the **METER** switch.

1-BYTE MEMORY CHANNEL NUMBER DATA STRUCTURE

This identifies the current or last-selected memory channel 1 ~ 99, P1 ~ P5 or QMB 1 ~ 5 for operation. The table below translates hexadecimal codes into corresponding memory channel numbers. Please read the note in the box at the page bottom.

Memory Channel Data (Hex Codes)							
Ch.	Hex	Ch.	Hex	Ch.	Hex	Ch.	Hex
01	00H	31	1EH	61	3CH	91	5AH
02	01H	32	1FH	62	3DH	92	5BH
03	02H	33	20H	63	3EH	93	5CH
04	03H	34	21H	64	3FH	94	5DH
05	04H	35	22H	65	40H	95	5EH
06	05H	36	23H	66	41H	96	5FH
07	06H	37	24H	67	42H	97	60H
08	07H	38	25H	68	43H	98	61H
09	08H	39	26H	69	44H	99	62H
10	09H	40	27H	70	45H	P1	63H
11	0AH	41	28H	71	46H	P2	64H
12	0BH	42	29H	72	47H	P3	65H
13	0CH	43	2AH	73	48H	P4	66H
14	0DH	44	2BH	74	49H	P5	67H
15	0EH	45	2CH	75	4AH	P6	68H
16	0FH	46	2DH	76	4BH	P7	69H
17	10H	47	2EH	77	4CH	P8	6AH
18	11H	48	2FH	78	4DH	P9	6BH
19	12H	49	30H	79	4EH	Q1	6CH
20	13H	50	31H	80	4FH	Q2	6DH
21	14H	51	32H	81	50H	Q3	6EH
22	15H	52	33H	82	51H	Q4	6FH
23	16H	53	34H	83	52H	Q5	70H
24	17H	54	35H	84	53H		
25	18H	55	36H	85	54H		
26	19H	56	37H	86	55H		
27	1AH	57	38H	87	56H		
28	1BH	58	39H	88	57H		
29	1CH	59	3AH	89	58H		
30	1DH	60	3BH	90	59H		

Important Note!

The Hex Memory Channel Codes for returned memory data shown above (Byte 7) **are different** than those used in upload command data (opcodes)!

The memory channel hex codes used as argument (parameter) bytes for opcodes are offset by one (that is, one value greater) from their returned data counterparts. Therefore the channel hex codes used in opcodes **02H**, **03H**, and **0DH** would range from **01H** ~ **71H**.

When constructing command block bytes, ensure that the correct memory channel hex code is used!

16-BYTE DATA RECORD STRUCTURE

The following tables outline the 16-byte data record structure common to the Operating Data, VFO-A, VFO-B and Memory Data records. The table below shows assignments for each of the 16-bytes in the Operating Data Record.

Byte	16-Byte Data Record Assignment
0	Band Selection
1	Operating Frequency
2	
3	
4	
5	Clarifier Offset
6	
7	Operating Mode
8	IF Filter Offset
9	VFO/MEM Operating Flags
A ~ F	Not Used

Band Selection - The 0.1~30 MHz transceiver operating range is divided into 28 bands, represented in hexadecimal format in the table below. Data read in this record after downloading is in binary format, and must be converted to hexadecimal, then translated to the corresponding band.

Hex Code	Band	Hex Code	Band
01H	0.1 ~ 0.5 MHz	0FH	10.5 ~ 12.0 MHz
02H	0.5 ~ 1.5 MHz	10H	12.0 ~ 14.0 MHz
03H	1.5 ~ 1.8 MHz	11H	14.0 ~ 14.5 MHz
04H	1.8 ~ 2.0 MHz	12H	14.5 ~ 15.0 MHz
05H	2.0 ~ 2.5 MHz	13H	15.0 ~ 18.0 MHz
06H	2.5 ~ 3.0 MHz	14H	18.0 ~ 18.5 MHz
07H	3.0 ~ 3.5 MHz	15H	18.5 ~ 21.0 MHz
08H	3.5 ~ 4.0 MHz	16H	21.0 ~ 21.5 MHz
09H	4.0 ~ 6.5 MHz	17H	21.5 ~ 22.0 MHz
0AH	6.5 ~ 7.0 MHz	18H	22.0 ~ 24.5 MHz
0BH	7.0 ~ 7.5 MHz	19H	24.5 ~ 25.0 MHz
0CH	7.5 ~ 8.0 MHz	1AH	25.0 ~ 28.0 MHz
0DH	8.0 ~ 10.0 MHz	1BH	28.0 ~ 29.0 MHz
0EH	10.0 ~ 10.5 MHz	1CH	29.0 ~ 30.0 MHz

The Band Selection data byte is divided into two 4-bit fields, representing the first and second value of the band number hex code. The Bit 0 and Bit 1 of the first field are used as flags for the memory mask and scan skip feature. A bit value of "1" means enabled, and "0" for disabled. Each value of the hex code is entered into its respective field in 4-bit binary format. The table below outlines the Data Byte field, and show an example of how the 24.5 ~ 25.0 MHz band would be read as:

Band Selection Data Byte (0)							
Bit 0*	Bit 1**	Bit 2	Bit 3	Bit 4	Bit 5	Bit 6	Bit 7
Field 1				Field 2			
0*	0**	0	1	1	0	0	1
*Mem Mask	**Scan Skip	0001 = 1		1001 = 9			
"0" = Off		19H = 24.5 ~ 25.0 MHz					
"1" = On		(refer to band chart)					

Operating Frequency - Likewise, the current operating frequency is similarly coded, this time into four bytes comprised of eight fields, from MSB to LSB. For example, a read binary value of 0000 0000 0001 0101 1011 1110 0110 1000 is 15BC68 (HEX) = 14.250.00 MHz as follows:

Operating Frequency Data Bytes (1-4)																							
Byte 1		Byte 2		Byte 3		Byte 4																	
Field 1 MSB	Field 2	Field 3	Field 4	Field 5	Field 6	Field 7	Field 8 LSB																
0	0	0	0	0	1	0	1	0	1	0	1	1	1	1	0	0	1	1	1	1	0	0	0
0		0		1		5		B		C		6		8									
0015BC68 (HEX) = 1,425,000 = 14.250.00 MHz																							

Clarifier Offset - Clarifier offset is written using 16-bit binary data in two bytes. Negative offsets are expressed in binary 2s-complement format, with a leading bit flag value* of "1." Although frequency resolution below 10 Hz cannot be viewed, absolute Clarifier offsets down to 0.625 Hz can be read from downloaded data.

Arithmetic conversion must be done on the binary value to arrive at the actual frequency offset (multiplying the 16-bit binary offset by 0.625). For example, a binary value of 0011 1110 0110 1111 (3E6FH or 15,983) multiplied by 0.625 results in an offset of +9989.375 Hz.

CAT System Computer Control

16-BYTE DATA RECORD STRUCTURE

A value of 1011 1110 0110 1111 (the 2-s complement of the previous example) produces a minus offset of -9989.375 Hz. See the byte chart below for a breakdown of the conversion process.

Clarifier Offset Data Bytes (5-6)														
Byte 5				Byte 6										
1*	0	1	1	1	1	0	0	1	1	0	1	1	1	1
1* ("–" flag) 011 1110 0110 1111 = (–) 3E6F (HEX) = (–)15,983 (–)15,983 x 0.625 = (–) 9989.375 Hz														
*Note - Remember that the first bit is a flag: "0" for positive offsets, "1" for negative offsets, and is not included in calculations.														

Operating Mode - The operating mode is expressed as a three-bit binary code in offsets 5 ~ 7. Bit 0 contains a User Mode flag, while Bits 1~4 contain "dummy" values (unused).

Operating Mode Byte (7)							
Bit 0*	Bit 1	Bit 2	Bit 3	Bit 4	Bit 5	Bit 6	Bit 7
User Mode	N/A - "dummy bytes"				Mode Data (3-bit Code)		
0	X	X	X	X	0	1	0
0XXXX010 = CW operation, User Mode Off							
0 = off 1 = on	Bits 1 ~ 3 are "dummy bits" - any 1/0 combination may appear in here, but is insignificant.				LSB	000	
					USB	001	
					CW	010	
					AM	011	
					FM	100	
					RTTY	101	
					PKT	110	

IF Filter Selection - The first data bit (Bit 0) contains a flag indicating normal or alternate reception mode (see table). The remainder of the data byte contains 2 x 4-bit fields separated by a dummy bit. The first field holds the 3-bit binary code for the 8.2 MHz 2nd IF filter selection, while the second holds the 455 kHz 3rd IF selection. Codes are listed in the bottom of the table below.

IF Filter Selection Byte (8)							
Bit 0*	Bit 1	Bit 2	Bit 3	Bit 4	Bit 5	Bit 6	Bit 7
	8.2 MHz 2nd IF				455 kHz 3rd IF		
RX Mode	Thru	000		X	6.0k	000	
	2.4k	001			2.4k	001	
	2.0k	010			2.0k	010	
	500	011			500	011	
	250	100			250	100	
Mode*	CW	AM			RTTY	PKT	
0	USB	ENV			LSB	LSB	
1	LSB	SYNC			USB	FM	

VFO/MEM Indicators - Five flags indicate the status of Clarifier (Rx & Tx), Repeater Offset (+/-), and Antenna Selection (A/B/RX). Bits 0 and 1 are not used (dummy values).

Clarifier, RPT, ANT Status Byte (9)							
Bit 0*	Bit 1	Bit 2	Bit 3	Bit 4	Bit 5	Bit 6	Bit 7
TX CLAR	RX CLAR	+RPT	-RPT	ANT SELECT		X	X
Note: for all flag bits, 1 = On, 0 = Off for ANT SELECT: 00 = ANT-A, 01 = ANT-B, 10 = RX ANT							

CODING EXAMPLES

Although Vertex Standard does not provide **CAT** control software (owing to the large variety of computers and operating systems used by our customers), the following are a few examples of critical **CAT** I/O functions, in Basic. Note that all variations of Basic may not support some of the commands, in which case alternate algorithms may need to be developed to duplicate the functions of those shown.

SENDING A COMMAND

After "opening" the computer's serial port for 4800-baud, 8 data bits and 2 stop bits with no parity, as I/O device #2, any **CAT** command may be sent. However, if you determine that your computer may need extra time to process data returned from the transceiver, you should send the Pacing command first. Here is an example of the Pacing command setting a 2-ms delay:

```
PRINT #2,  
CHR$(0);CHR$(0);CHR$(0);CHR$(2);CHR$(&HE);
```

Notice that the instruction opcode is sent last, with the first (MSB) parameter sent just before it, and the LSB parameter (or dummies) sent first. This means that the parameters are sent in the reverse order from that in which they appear in the **CAT** Commands table. Also note that in this and the following examples, we are sending zeros as dummy bytes; this is not necessary, however. If you decide to send commands through a 5-byte array, the values of the dummy parameters need not be cleared. Also note the semicolon at the end of the line, to prevent Basic from sending extra bytes to "end the line" (the **CAT** system control system is based on binary streams, not text streams).

Using the same example as on page 87, the following command could be used to set the frequency of the display to 14.25000 MHz:

```
PRINT #2,  
CHR$(&H00);CHR$(&H50);CHR$(&H42);CHR$(&H01);  
CHR$(&HA);
```

Notice here that the BCD values can be sent just by preceding the decimal digits with "&H" in this ex-

ample. However, in an actual program, it may be preferable to convert the decimal frequency variable in the program to an ASCII string, and then to convert the string to characters through a lookup table.

If you send a parameter that is out of range for the intended function, or not among the specified legal values for that function, the **MARK-V FT-1000MP Field** should do nothing. Therefore, you may wish to alternate your sending regular commands or command groups with the Read Flags or short-form Update commands, allowing the transceiver to let the computer know if everything sent so far has been accepted and acted upon as expected.

Bear in mind that some commands specify "binary," as opposed to BCD formatted parameters. You can send binary parameters without going through the character/hex string conversion process. For example, the CH parameter in the Command table is a binary value. You could have the **MARK-V FT-1000MP Field** recall memory channel 50 (decimal) by the following:

```
PRINT#2,  
CHR$(0);CHR$(0);CHR$(0);CHR$(49);CHR$(2);
```

Note that we must send 49 to get channel 50, since the channel numbers in the command start from 0, while those on the display start with 1.

READING RETURNED DATA

The reading process is easily done through a loop, storing incoming data into an array, which can then be processed after the entire array has been read. To read the meter:

```
FOR I=1 TO 5  
MDATA(I) = ASC(INPUT$(1,#2))  
NEXT I
```

Recall from above that the meter data consists of four identical bytes, followed by a filler byte, so we really only need to see one byte to get all of the information this command offers. Nevertheless, we must read all five bytes (or 1, 16, or 1,863, in the case of the Update data). After reading all of the data, we can select the bytes of interest to us from the array (MDATA, in the above example).

CAT System Computer Control

Opcode Command Chart (1)

Command or Key	Parameter Bytes				Opcode	Parameter Description
	1st	2rd	3rd	4th		
SPLIT	-	-	-	T	01H	Split Tx/Rx operation ON (T = 01H) or OFF (T = 00H)
Recall Memory	-	-	-	X	02H	Recalls memory number X: 01H ~ 71H, corresponding to memories 1 ~ 99, P1 ~ P9, and QMB 1 ~ QMB 5.
VFO/MEM	-	-	K	X	03H	Enter (K = 00H), Mask (K = 01H) or Un-Mask (K = 02H), memory channel X (01H ~ 71H).
LOCK	-	-	-	P	04H	Tuning knob Lock/Unlock: P = 00H: Main Dial Lock P = 01H: Main Dial Unlock P = 02H: Sub Dial Lock P = 03H: Main Dial Unlock
A/B	-	-	-	V	05H	Select VFO-A (V = 00H), or VFO=B (V = 02H).
[M▶B]	-	-	-	X	06H	Copy memory X (01H ~ 71H) to last-used VFO.
UP (▲)	-	-	U	V	07H	Step VFO-A/B (V = 00H/01H) up by 100 kHz/1 MHz (U = 00H/01H).
DOWN (▼)	-	-	D	V	08H	Step VFO-A/B (V = 00H/01H) down by 100 kHz/1 MHz (D = 00H/01H).
CLAR	C1	C2	C3	C4	09H	Clarifier offset direction & frequency in BCD C1 = Hz offset (C1 = 00H ~ 99H) C2 = kHz offset (C2 = 00H ~ 09H) C3 = Hz offset (C3 = 00H/FFH) Clarifier On/Off/Reset: C4 = RX CLAR ON/OFF (C4 = 00H/01H) TX CLAR ON/OFF (C4 = 80H/81H) CLAR CLEAR (C4 = FFH)
Set Main VFO-A Operating Freq.	F1	F2	F3	F4	0AH	New operating frequency in BCD format (F1 ~ F4) see text for formatting example.
MODE	-	-	-	M	0CH	Select Operating Mode M: LSB: M = 00H USB: M = 01H CW: M = 02H CW (R): M = 03H AM: M = 04H AM(Sync): M = 05H FM: M = 06H FM-W: M = 07H RTTY (L): M = 08H RTTY (U): M = 09H PKT (L): M = 0AH PKT (F): M = 0BH
Pacing	-	-	-	N	0EH	Add N-millisecs (00H ~ FFH) delay between each byte of all downloaded data returned from the transceiver
PTT	-	-	-	T	0FH	Transmitter ON (T = 01H) or OFF (T = 00H)
Status Update	X	-	-	U	10H	Instructs the radio to return 1, 16, 32, or 1863 bytes of Status Update data. X is significant only when U = 1 ~ 4. X = 00H ~ 71H: desired memory channel (1 ~ 99, P1 ~ P9, or QMB 1 ~ QMB 5) U = 00H All 1863 byte U = 01H 1-byte Memory Channel Number U = 02H 16-byte Operating Data U = 03H 2 x 16-byte VFO (A & B) Data U = 04H 1 x 16-byte Memory Data

CAT System Computer Control

Opcode Command Chart (2)

Command or Key	Parameter Bytes				Opcode	Parameter Description
	1st	2rd	3rd	4th	5th	
Electronic Keyer	K1	K2	K3	K4	70H	<p>Activates remote control and contest keyer functions.</p> <p>K1 = 00H (fixed value)</p> <p>K2 = keyer function:</p> <ul style="list-style-type: none"> 00H = Message 0 01H = Message 1 02H = Message 2 03H = Message 3 04H = CQ/ID Message 05H = Contest Number 06H = Decrement Contest Number 07H = Increment Contest Number 08H = Message Playback m/o Tx 09H = Write Message into Memory <p>K3 = 01H (fixed value)</p> <p>K4 = 1BH (fixed value)</p>
EDSP Enhanced Digital Signal Processing	-	-	P1	P2	75H	<p>EDSP Settings, where P2 is:</p> <ul style="list-style-type: none"> RX EDSP OFF (30H), P1 = 00H AM EDSP Demodulation On (31H), P1 = 00H USB EDSP Demodulation (32H), with audio response of 100 Hz ~ 3.1 kHz (P1 = 00H) or 300 Hz ~ 2.8 kHz (P1 = 10H) LSB EDSP Demodulation (33H), with audio response of 100 Hz ~ 3.1 kHz (P1 = 00H) or 300 Hz ~ 2.8 kHz (P1 = 10H) AF Filter Off (40H), P1 = 00H AF LPF On (41H), where P1 = [FCUTOFF (Hz)]/20 (HEX format) AF HPF On (42H), where P1 = [FCUTOFF (Hz)]/20 (HEX format) CW 240 Hz BWF (45H), where P1 = FCENTER (BCD format) CW 120 Hz BWF (46H), where P1 = FCENTER (BCD format) CW 60 Hz BWF (47H), where P1 = FCENTER (BCD format) Data Mode AF Filter On (48H), where P1 = FSK (10H), SSTV (20H), Packet (30H), or FAX (40H) Random Noise Filter (4AH) Off/On (P1 = 00H/1YH) Audio Notch Filter (4BH) Off/On (P1 = 00H/10H) Noise Reducer (4EH), where P1 = Off (00H), NR A (10H), NR B (20H), NR C (30H), NR D (40H) TX EDSP Off (B0H) USB EDSP Modulation (B2H), with audio response of: 100 Hz ~ 3.1 kHz (P1 = 10H), 50 Hz ~ 3.1 kHz (P1 = 20H), 200 Hz ~ 3.1 kHz (P1 = 30H), 300 Hz ~ 3.1 kHz (P1 = 40H) LSB EDSP Modulation (B3H), with audio response of: 100 Hz ~ 3.1 kHz (P1 = 10H), 150 Hz ~ 3.1 kHz (P1 = 20H), 200 Hz ~ 3.1 kHz (P1 = 30H), 300 Hz ~ 3.1 kHz (P1 = 40H), TX Audio EDSP (C1H), where P1 = Off (00H), Bank 1 (10H), Bank 2 (20H), Bank 3 (30H), Bank 4 (40H)

CAT System Computer Control

Opcode Command Chart (3)

Command or Key	Parameter Bytes				Opcode	Parameter Description																																	
	1st	2rd	3rd	4th																																			
TUNER	-	-	-	T	81H	Switch Antenna Tuner ON (T = 01H) or OFF (T = 00H)																																	
Tuner Start	-	-	-	-	82H	Start Antenna Tuning																																	
Dual Operation	-	-	-	D	83H	Switch Dual Receive ON (D = 01H) or OFF (D = 00H)																																	
[RPT]	-	-	-	R	84H	Switch Simplex Operation (R = 00H), Minus Shift (R = 01H), or Plus Shift (R = 02H) for Repeater Operation																																	
[A▶B]	-	-	-	-	85H	Copy Data Display in VFO-A or VFO-B.																																	
Set SUB VFO-B Operating Freq.	F1	F2	F3	F4	8AH	Enter new operating frequency in F1 ~ F4, in BCD format: see text for example.																																	
BANDWIDTH 2nd & 3rd IF Filter Selection	X1	-	-	X4	8CH	Select filter bandwidth for selected IF (see below): <table style="width: 100%; border: none;"> <tr> <td style="text-align: left;">VFO-A</td> <td style="text-align: left;">VFO-B</td> <td style="text-align: left;">IF (VFO-A)</td> </tr> <tr> <td>THRU: X4 = 04</td> <td>6.0 kHz: X4 = 84</td> <td>Both: X1 = 00</td> </tr> <tr> <td>2.4 kHz: X4 = 00</td> <td>2.4 kHz: X4 = 80</td> <td>8.2 MHz: X1 = 01</td> </tr> <tr> <td>2.0 kHz: X4 = 01</td> <td>2.0 kHz: X4 = 81</td> <td>455 kHz: X1 = 02</td> </tr> <tr> <td>500 Hz: X4 = 02</td> <td>500 Hz: X4 = 82</td> <td></td> </tr> <tr> <td>250 Hz: X4 = 03</td> <td>250 Hz: X4 = 83</td> <td></td> </tr> </table>	VFO-A	VFO-B	IF (VFO-A)	THRU: X4 = 04	6.0 kHz: X4 = 84	Both: X1 = 00	2.4 kHz: X4 = 00	2.4 kHz: X4 = 80	8.2 MHz: X1 = 01	2.0 kHz: X4 = 01	2.0 kHz: X4 = 81	455 kHz: X1 = 02	500 Hz: X4 = 02	500 Hz: X4 = 82		250 Hz: X4 = 03	250 Hz: X4 = 83																
VFO-A	VFO-B	IF (VFO-A)																																					
THRU: X4 = 04	6.0 kHz: X4 = 84	Both: X1 = 00																																					
2.4 kHz: X4 = 00	2.4 kHz: X4 = 80	8.2 MHz: X1 = 01																																					
2.0 kHz: X4 = 01	2.0 kHz: X4 = 81	455 kHz: X1 = 02																																					
500 Hz: X4 = 02	500 Hz: X4 = 82																																						
250 Hz: X4 = 03	250 Hz: X4 = 83																																						
MEM. Channel Scan Skip	-	-	S	X	8DH	Tag memory channels 1 through 99 (X = 01H ~ 6CH), to be skipped (S = 01H) or included (S = 00H) while scanning.																																	
Step VFO-A UP/DOWN	-	-	-	T	8EH	Step frequency of VFO-A UP (T = 00H) or DOWN (T = 01H)																																	
CTCSS Encoder Tone Frequency Select	E	E	E	E	90H	Select one of 33 CTCSS subaudible tones where E = 00H ~ 20H <table style="width: 100%; border: none;"> <tr> <td>E = 00H 67.0 Hz</td> <td>E = 0BH 118.8 Hz</td> <td>E = 16H 173.8 Hz</td> </tr> <tr> <td>E = 01H 71.9 Hz</td> <td>E = 0CH 123.0 Hz</td> <td>E = 17H 179.9 Hz</td> </tr> <tr> <td>E = 02H 77.0 Hz</td> <td>E = 0DH 127.3 Hz</td> <td>E = 18H 186.2 Hz</td> </tr> <tr> <td>E = 03H 82.5 Hz</td> <td>E = 0EH 131.8 Hz</td> <td>E = 19H 192.8 Hz</td> </tr> <tr> <td>E = 04H 88.5 Hz</td> <td>E = 0FH 136.5 Hz</td> <td>E = 1AH 203.5 Hz</td> </tr> <tr> <td>E = 05H 94.8 Hz</td> <td>E = 10H 141.3 Hz</td> <td>E = 1BH 210.7 Hz</td> </tr> <tr> <td>E = 06H 100.0 Hz</td> <td>E = 11H 146.2 Hz</td> <td>E = 1CH 218.1 Hz</td> </tr> <tr> <td>E = 07H 103.5 Hz</td> <td>E = 12H 151.4 Hz</td> <td>E = 1DH 225.7 Hz</td> </tr> <tr> <td>E = 08H 107.2 Hz</td> <td>E = 13H 156.7 Hz</td> <td>E = 1EH 233.6 Hz</td> </tr> <tr> <td>E = 09H 110.9 Hz</td> <td>E = 14H 162.2 Hz</td> <td>E = 1FH 241.8 Hz</td> </tr> <tr> <td>E = 0AH 114.8 Hz</td> <td>E = 15H 167.9 Hz</td> <td>E = 20H 250.3 Hz</td> </tr> </table>	E = 00H 67.0 Hz	E = 0BH 118.8 Hz	E = 16H 173.8 Hz	E = 01H 71.9 Hz	E = 0CH 123.0 Hz	E = 17H 179.9 Hz	E = 02H 77.0 Hz	E = 0DH 127.3 Hz	E = 18H 186.2 Hz	E = 03H 82.5 Hz	E = 0EH 131.8 Hz	E = 19H 192.8 Hz	E = 04H 88.5 Hz	E = 0FH 136.5 Hz	E = 1AH 203.5 Hz	E = 05H 94.8 Hz	E = 10H 141.3 Hz	E = 1BH 210.7 Hz	E = 06H 100.0 Hz	E = 11H 146.2 Hz	E = 1CH 218.1 Hz	E = 07H 103.5 Hz	E = 12H 151.4 Hz	E = 1DH 225.7 Hz	E = 08H 107.2 Hz	E = 13H 156.7 Hz	E = 1EH 233.6 Hz	E = 09H 110.9 Hz	E = 14H 162.2 Hz	E = 1FH 241.8 Hz	E = 0AH 114.8 Hz	E = 15H 167.9 Hz	E = 20H 250.3 Hz
E = 00H 67.0 Hz	E = 0BH 118.8 Hz	E = 16H 173.8 Hz																																					
E = 01H 71.9 Hz	E = 0CH 123.0 Hz	E = 17H 179.9 Hz																																					
E = 02H 77.0 Hz	E = 0DH 127.3 Hz	E = 18H 186.2 Hz																																					
E = 03H 82.5 Hz	E = 0EH 131.8 Hz	E = 19H 192.8 Hz																																					
E = 04H 88.5 Hz	E = 0FH 136.5 Hz	E = 1AH 203.5 Hz																																					
E = 05H 94.8 Hz	E = 10H 141.3 Hz	E = 1BH 210.7 Hz																																					
E = 06H 100.0 Hz	E = 11H 146.2 Hz	E = 1CH 218.1 Hz																																					
E = 07H 103.5 Hz	E = 12H 151.4 Hz	E = 1DH 225.7 Hz																																					
E = 08H 107.2 Hz	E = 13H 156.7 Hz	E = 1EH 233.6 Hz																																					
E = 09H 110.9 Hz	E = 14H 162.2 Hz	E = 1FH 241.8 Hz																																					
E = 0AH 114.8 Hz	E = 15H 167.9 Hz	E = 20H 250.3 Hz																																					
Read Meter & Panel Controls	-	-	-	-	F7H	Instruct radio to return digitized indications of various meter level readings and front panel control settings (4 repeated bytes, and F7H) selected by: <table style="width: 100%; border: none;"> <tr> <td>M = 00H Main S-Meter</td> <td>M = 87H TUN Meter</td> </tr> <tr> <td>M = 01H Sub S-Meter</td> <td>M = F0H Shuttle Jog Dial</td> </tr> <tr> <td>M = 80H PO Meter</td> <td>M = F1H CW Pitch Setting</td> </tr> <tr> <td>M = 81H ALC Meter</td> <td>M = F2H Remote Control A/D Level</td> </tr> <tr> <td>M = 83H IC Meter</td> <td>M = F3H SHIFT Setting</td> </tr> <tr> <td>M = 84H VCC Meter</td> <td>M = F4H WIDTH Setting</td> </tr> <tr> <td>M = 85H SWR Meter</td> <td>M = F5H EDSP Contour Selection</td> </tr> <tr> <td>M = 86H MIC Meter</td> <td>M = F6H EDSP NR Selection</td> </tr> </table>	M = 00H Main S-Meter	M = 87H TUN Meter	M = 01H Sub S-Meter	M = F0H Shuttle Jog Dial	M = 80H PO Meter	M = F1H CW Pitch Setting	M = 81H ALC Meter	M = F2H Remote Control A/D Level	M = 83H IC Meter	M = F3H SHIFT Setting	M = 84H VCC Meter	M = F4H WIDTH Setting	M = 85H SWR Meter	M = F5H EDSP Contour Selection	M = 86H MIC Meter	M = F6H EDSP NR Selection																	
M = 00H Main S-Meter	M = 87H TUN Meter																																						
M = 01H Sub S-Meter	M = F0H Shuttle Jog Dial																																						
M = 80H PO Meter	M = F1H CW Pitch Setting																																						
M = 81H ALC Meter	M = F2H Remote Control A/D Level																																						
M = 83H IC Meter	M = F3H SHIFT Setting																																						
M = 84H VCC Meter	M = F4H WIDTH Setting																																						
M = 85H SWR Meter	M = F5H EDSP Contour Selection																																						
M = 86H MIC Meter	M = F6H EDSP NR Selection																																						
Repeater Offset	X1	X2	X3	X4	F9H	Set offset for RPT shift, valid values are 0 ~ 500 kHz in 1-kHz step. Use BCD format for X2 ~ X4. X1 is 10's & 100's of Hz X2 is 1's & 10's of kHz X3 is must be 00H , 01H , or 02H X4 is must be 00H																																	

CAT System Computer Control

Opcode Command Chart (4)

Command or Key	Parameter Bytes				Opcode	Parameter Description														
	1st	2rd	3rd	4th	5th															
Read Internal Status Flags	-	-	-	F	FAH	<p>Instructs radio to return either five or six status flag bytes.</p> <table> <tr> <td>5-Byte Format (F = 00H)</td> <td>6-Byte Format (F = 01H)</td> </tr> <tr> <td>Status Flag Byte #1</td> <td>Status Flag Byte #1</td> </tr> <tr> <td>Status Flag Byte #2</td> <td>Status Flag Byte #2</td> </tr> <tr> <td>Status Flag Byte #3</td> <td>Status Flag Byte #3</td> </tr> <tr> <td>*ID Byte #1 (03H)</td> <td>Status Flag Byte #4</td> </tr> <tr> <td>*ID Byte #2 (93H)</td> <td>Status Flag Byte #5</td> </tr> <tr> <td></td> <td>Status Flag Byte #6</td> </tr> </table> <p>* See page 89 for explanation of transceiver ID byte values.</p>	5-Byte Format (F = 00H)	6-Byte Format (F = 01H)	Status Flag Byte #1	Status Flag Byte #1	Status Flag Byte #2	Status Flag Byte #2	Status Flag Byte #3	Status Flag Byte #3	*ID Byte #1 (03H)	Status Flag Byte #4	*ID Byte #2 (93H)	Status Flag Byte #5		Status Flag Byte #6
5-Byte Format (F = 00H)	6-Byte Format (F = 01H)																			
Status Flag Byte #1	Status Flag Byte #1																			
Status Flag Byte #2	Status Flag Byte #2																			
Status Flag Byte #3	Status Flag Byte #3																			
*ID Byte #1 (03H)	Status Flag Byte #4																			
*ID Byte #2 (93H)	Status Flag Byte #5																			
	Status Flag Byte #6																			

Menu Selection and Settings

INTRODUCTION

In earlier chapters, basic and advanced operation were covered to explain the various transceiver features. This chapter covers all of the menu selections and their settings used by the transceiver. These functions were described previously, but must be configured as desired using menu programming. Menu selections are shown as they appear in the display to assist you as you go along.

MENU SELECTIONS

Eighty-two transceiver settings are contained in programming menu (refer to the menu list shown on the opposite page).

- ❑ To enter the "Menu" mode, press and hold in [FAST], then press [ENT].
- ❑ The SUB VFO-B display will show the selection name, while the Main VFO display field shows the current setting for the selected menu item.
- ❑ Rotating the **VRF/MEM CH** knob displays the various menu selections, whose numbers appear in the memory channel box.
- ❑ Rotating the **Main VFO knob**, once you have selected a menu item, lets you choose between the various settings available for the displayed selection. Some settings are merely an off/on switch, while others are variable tuning step sizes, time and frequency values, or mode choices.

Easy Recall Menu

Several menu selections can be accessed directly via two keystrokes from the front panel:

[FAST] + [NB]	Menu 2-8 (nb)
[FAST] + [NOTCH]	Menu 2-9 (notch)
[FAST] + [VCC/MIC]	Menu 3-4 (briGHt)
[FAST] + [BK-IN]	Menu 7-5 (kyr-dLy)
[FAST] + RX-(SUB VFO-B)	Menu 8-7 (Sub-AGc)

0-1 GrP1-cH

Selects the number of default memory channels (from 1-99) available within Memory Group 1. If all 99 memory channels are enabled, Memory Group 2 is not configurable.

0-2 GrP2-cH

Selects the number of memory channels (from 1-99) available within Memory Group 2 (if less than 99 memory channels are enabled in Memory Group 1). If all 99 memory channels are enabled, Memory Group 3 is not configurable.

0-3 GrP3-cH

Selects the number of memory channels available within Memory Group 3 (if Groups 1 and 2 are not configured for 99 channels total). If all 99 memory channels are enabled, Memory Group 4 is not configurable.

0-4 GrP4-cH

Selects the number of memory channels available within Memory Group 4 if Groups 1, 2, and 3 are not configured for 99 channels total. If all 99 memory channels are enabled, Memory Group 5 is not configurable.

0-5 GrP5-cH

Selects the number of memory channels available within memory Group 5 (to 99 total) if Groups 1, 2, 3, and 4 are not configured for 99 channels total.

0-6 quick-cH

Quick Memory Bank Channels - Allocates 1 to 5 memories for use with the instant-write "quick-memory" feature.

0-7 (Not Used)

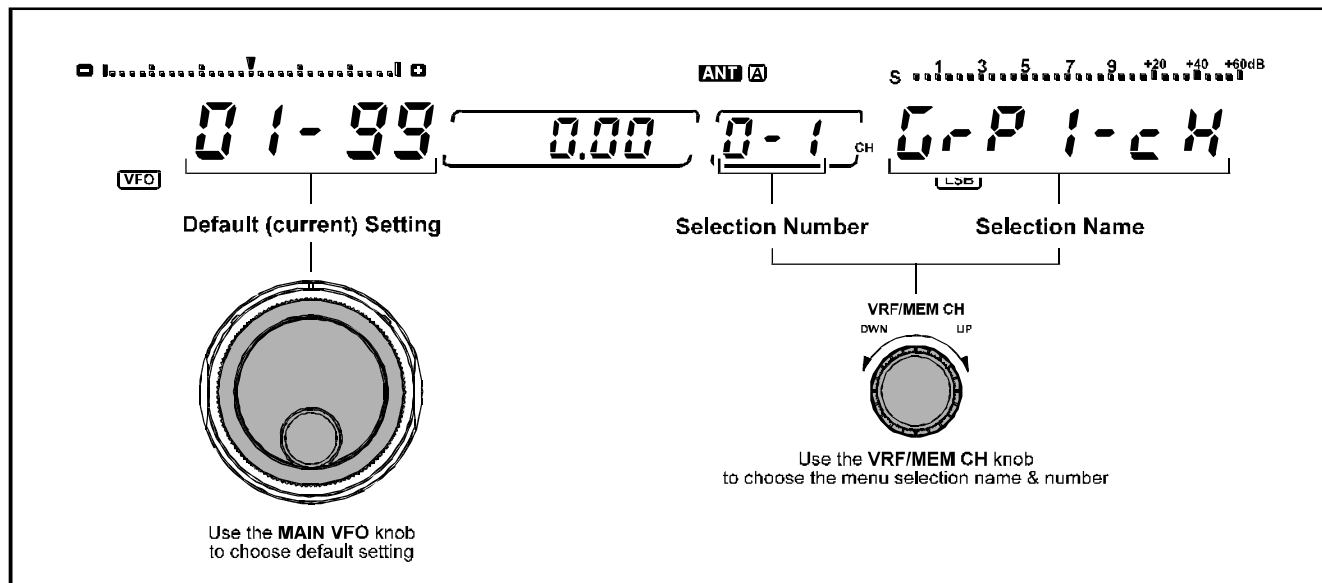

0-8 Auto-uP

Auto Channel Up - When programming memories from the VFO, this feature automatically increments selection to the next higher memory channel. This allows programming sequential memories more easily (you don't have to manually select the next memory to be written). This also prevents inadvertently overwriting stored memories.

0-9 EdSP

EDSP on/off - Enables/Disables the EDSP feature. This parameter should always be set to "On" unless you have a compelling reason not to use the EDSP system.

1-0 diAL-SPd

VFO A & B Dial FAST Tuning Rate - Selects x2 or x4 tuning when the [FAST] button is pressed.

1-1 SJ-SPEEd

Shuttle Jog Encoder Speed - Selects the encoder pulse duration from 1 ~ 100 msec (in 1 msec steps).

1-2 Sft-STEP

IF SHIFT/WIDTH Control Tuning Step Size - Selects 10 or 20-Hz step size. Total knob tuning range is 62 encoder steps (with 20-Hz step size the shift range is double that with 10-Hz).

1-3 A-STEP

MAIN VFO-A Tuning Step Size - Selects 0.625 Hz, 1.25 Hz, 2.5 Hz, 5 Hz, 10 Hz, or 20 Hz tuning steps.

1-4 b-STEP

SUB VFO-B Tuning Step Size - Selects 0.625 Hz, 1.25 Hz, 2.5 Hz, 5 Hz, 10 Hz, or 20 Hz tuning steps.

1-5 cH-STEP

VFO Channel Step Size - For the Channel Stepping feature, step size can be selected from 1 ~100 kHz (in 1-kHz increments).

1-6 q-SPLit

Quick Split Offset Tuning - Select a tuning offset of up to ± 100 kHz (in 1-kHz steps). See *menu selection 8-2*: Split mode, A=B.

1-7 AutoFAST

Automatic Selecting of AGC recovery time - When the front panel AGC selector is set to the "AUTO" position and this feature is "ON," the AGC decay time automatically is set to "FAST" during the following operating situations:

- During scanning;
- In 250/500 Hz bandwidth; and
- When you turn the VFO Knob for more than ½-second.

1-8 cLAr-tun

Clarifier Tuning Offset - Enables/disables the offset tuning meter above the Main VFO frequency display. As the [CLAR] control is rotated and the TX or RX frequency is offset, a single meter segment shifts to show your relative offset from the original frequency.

1-9 cLAr-StP

Clarifier Tuning Step Size - Selects 0.625 Hz, 1.25 Hz, 2.5 Hz, 5 Hz, 10 Hz, or 20 Hz tuning steps used with the RX and TX CLAR control.

2-0 Scn-PAuS

Scan Pause - Enables/disables pausing on activity while scanning.

2-1 Scn rES

Scan Resume Mode - Selects one of three scan-stop modes:

Carrier Stop - Scanning pauses on activity, resumes when signal disappears.

Carrier Timed Stop - Scanning pauses on activity for 5 seconds then resumes scanning for the next station (whether signal remains or not).

Carrier Timed Slow - Scanning slows down for 5 seconds after detecting activity, then resumes to normal scan rate.

2-2 (Not Used)

2-3 nScn-SPd

Memory Scan Speed - This sets the scan dwell time, which is the time duration that the scanner samples each memory channel. This duration can be set from 100 ~ 1000 msec, in 10 msec steps.

2-4 dScn-SPd

Dial (VFO) Scan Speed - This sets the dwell time that the scanner samples each VFO channel. This duration can be set from 1 ~ 100 msec, in 1 msec steps.

Menu Selection and Settings

2-5 Auto-in

Auto Memory Write - When enabled, active channels found during scanning are automatically written into ascending memory channels of the desired Memory Group, or all groups, until full.

2-6 ScAn-ALL

Memory Scan Skip - Enables/disables the memory scan skip feature. When OFF, memories marked for scan skip will be passed over during scanning. When ON, all memories are scanned.

2-7 Sc-dL-ti

Scan Delay Time - Selects a scanning delay time of 1 ~ 5 seconds. This determines how long scanning pauses on activity before resuming.

2-8 nb

Noise Blanker - Selects the IF Noise Blanker Type and its blanking level. Set this menu to "A1" ~ "A15" to activate the narrow pulse blanker, or "B1" ~ "B15" to activate the wide pulse blanker. Higher settings allow weaker noise sources to be blanked more effectively. Short-cut: Press & hold [FAST] & press [NB].

2-9 notch

Notch Operation - Selects Notch Filter operation:

IF NOTCH - Manual IF notch operation using the front panel knob with the same name. The EDSP notch is not accessible in this mode.

Auto DSP - When the EDSP is engaged (*menu selection 0-9* is set to "on"), the [NOTCH] button serves as an On/Off switch for the EDSP auto-notch filter. The EDSP notch filter automatically locates existing heterodynes and notches them out. Any additional heterodynes are also notched as they appear. The IF Notch is accessible only when the EDSP is turned off (*menu selection 0-9* is set to "off").

Select - If EDSP is engaged (*menu selection 0-9* is set to "on"), and the [NOTCH] button is pressed, both the EDSP Auto-Notch and IF notch operation take effect simultaneously. With EDSP disabled (*menu selection 0-9* is set to "off"), the manual IF notch is still available (by pressing the [NOTCH] key).

Short-cut: Press & hold [FAST] & press [NOTCH].

3-0 F-diSPLY

Frequency Display Format

Carrier - Displays the actual carrier frequency, without any offset added. When changing modes, the frequency display remains constant.

Offset - When changing modes, the frequency display changes to reflect the added BFO offset.

3-1 diSP-rES

Display Resolution - Selects 10 Hz, 100 Hz, or 1 kHz display frequency resolution for the Main- and Sub-VFO displays. Note that this setting does not affect tuning step size.

3-2 EtS-SEL

Expanded Tuning Scale - Selects the display format of the expanded tuning scale located above the main frequency display:

Dial - Permits sub-resolution tuning and display using small sub-increment segments that expand outward as the dial is turned.

Clarifier - Permits viewing relative Rx or Tx Clarifier offset from the displayed frequency. A single segment moves left or right from center as the CLAR knob is rotated.

3-3 tr-diSP

Transverter Display - Selects 50, 144, or 430 to be displayed in the 1's, 10's, and 100's of the MHz places, for operation with a transverter.

3-4 briGHt

LCD Display Brightness - Enables adjustment of the display intensity between High or Low.

3-5 PnL-diSP

Panel Offset Display Mode - Selects one of four parameters to be viewed in the smaller sub-display to the right of the Main VFO frequency display:

Clarifier - Displays "clarified" frequency offset ΔF_{rx} or ΔF_{tx} from original frequency.

Channel Freq. - Displays the operating frequency contained in the selected memory channel.

Offset - Displays the frequency difference (offset) between the displayed Main VFO and Sub VFO frequencies.

A1 (CW) Pitch - Displays the current CW pitch setting.

Note: When the Clarifier is switched on during operation, it will over-ride any setting of the Panel Sub-Display which may be different from "Clarifier."

3-6 S-bArdSP

Sub-Meter Bar Graph - Enables the S-meter bargraph segment display for the Sub VFO.

3-7 P-HoLd

Main Meter Peak-Hold - Enables/disables the peak-hold feature, and selects the display's bar/segment persistence (delay time) from 10 ~ 2000 msec.

3-8 SP-HoLd

Sub Meter Peak Hold - Enables/disables the peak-hold feature for the Sub-VFO meter, and selects the display bar/segment persistence (delay time) from 10 ~ 2000 msec.

3-9 (Not Used)

4-0 rF out

RF Power Output Range - Selects a maximum RF power output limit of Lo-1 (10W), Lo-2 (25W), or Hi (100W).

4-1 bEEP

Key & Panel Beeper - Enables/disables the beep that sounds when a front panel key or button is pressed.

4-2 bEEP-F

Beep Frequency - Adjusts the front panel key & button beep pitch from 220 ~ 7040 Hz. By turning the **SUB VFO-B** knob slightly so that “**bEEP-tun**” appears, a constant pitch matches the displayed pitch, which is adjusted using the **MAIN VFO-A** knob. This can be useful for making adjustments requiring an audio reference tone.

Note - beep volume can be adjusted via the hole on the bottom case of the transceiver. Insert a small insulated screwdriver and slowly turn the trimmer for the desired volume.

4-3 tun-drv

Tune-up Drive Power - Selects a maximum output power limit of Lo-1 (10W), Lo-2 (25W), or Hi (100W) for driving the input circuit of an external linear RF amplifier while tuning (while using the Remote Control function).

4-4 tr-EdSP

Transmit Audio EDSP - Disables or selects one of four available EDSP equalization techniques for transmitted microphone audio. This allows you to select an audio response which best matches your voice, allowing the transmitter’s *available power* to be focused most effectively, thereby maximizing the *useful power* output from the **MARK-V FT-1000MP Field**.

The available selections are:

OFF: This function is disabled.

- 1: Mid- and high-frequency components are enhanced with this setting.
- 2: A high-emphasis response is produced, ideal for pile-up or contest work.
- 3: Both low- and high-frequency components are emphasized.
- 4: A wide bandpass response is produced, emulating a “broadcast” microphone audio sound.

4-5 (not Used)

4-6 dvS-rEc

DVS Record VFO - Selects the Main receiver or the Sub receiver as the receive audio source to record from, when using the optional **DVS-2** (Digital Voice System).

4-7 dvS-Ptt

DVS-2 PTT - Enables/disables transmitter PTT control from the **DVS-2** unit.

4-8 HEAdPHon

Headphone Mode - Selects one of three audio mixing modes for use with headphones:

Mono - Audio from both the Main and Sub receivers is combined and heard equally in both ears.

Stereo 1 - Audio from both the Main and Sub receivers can be heard in each ear, but SUB VFO audio is attenuated in the left ear and MAIN VFO audio is attenuated in the right.

Stereo 2 - Audio from MAIN VFO-A is heard only in the left ear and SUB VFO-B in the right.

Note: Both VFOs must be activated by the [DUAL] button on the front panel, and the main and sub audio must be balanced using the **AF GAIN** and **SUB AF** controls, to experience this feature.

4-9 AF GAin

AF GAIN Control - Provides setup of the **AF GAIN** and **SUB AF** front panel controls:

Balance - The audio level for both VFOs is adjusted by the **AF GAIN** control, while the **SUB AF** control adjusts the balance.

Separate - The audio level for each VFO is adjusted separately (**AF GAIN** control for Main receiver’s volume, **SUB AF** control for Sub receiver’s volume).

5-0 SSb nor

SSB Normal Filters - Selects the SSB filters used when the front-panel [NOR] switch is selected (while in the SSB mode).

8.2 - Sets the 2nd IF filter to “through,” and the 3rd IF filter to “2.4 kHz.”

455 - Sets the 2nd IF filter to “2.4 kHz,” and the 3rd IF filter to “6.0 kHz.”

8.2-455 - Sets the 2nd IF filter to “through,” and 3rd IF filter to “6.0 kHz.”

oFF - Sets the 2nd IF filter and 3rd IF filter to “2.4 kHz.”

Menu Selection and Settings

5-1 8.2-2.0

2nd IF 2.0 kHz Filter - Enables/disables the optional 2.0 kHz IF filter (Yaesu P/N **YF-114SN**).

5-2 CW nor

CW Normal Filters - Selects the CW filters used when the front-panel **[NOR]** switch is selected (while in the CW mode).

8.2 - Sets the 2nd IF to the optional 2.0 kHz filter, and the 3rd IF to the 2.4 kHz filter.

455 - Sets the 2nd IF to the 2.4 kHz filter, and the 3rd IF to the optional 2.0 kHz filter.

8.2-455 - Sets the 2nd IF and 3rd IF filters to 2.0 kHz filter options.

Note: If you have not installed the optional 2.0 kHz filters (or if you disable the optional 2.0 kHz filters by *menu selection 5-1* and/or *5-5*), the received signal will pass through the standard 2.4 kHz filter.

5-3 8.2-250

2nd IF 250 Hz Filter - Enables/disables the optional 250 Hz IF filter (Yaesu P/N **YF-114CN**).

5-4 dAtAnAr2

DATA Narrow 2 Filters - Selects the filters used when the front-panel **[NAR2]** switch is selected (while in the DATA mode).

8.2 - Sets the 2nd IF to the optional 250 Hz filter, and the 3rd IF to the optional 500 Hz filter.

455 - Sets the 2nd IF to the 500 Hz filter, and the 3rd IF to the optional 250 Hz filter.

8.2-455 - Set the 2nd IF and 3rd IF filters to the 250 Hz filter options.

Note (1): If you have not installed the optional 2nd IF 500 Hz filter (or if you disable the filter by *menu selection 5-3*), the received signal will pass through the supplied 500 Hz filter.

Note (2): If you have not installed the optional 3rd IF 500 Hz filter (or if you disable the filter by *menu selection 5-6*), the received signal will pass through the supplied 2.4 kHz filter.

Note (3): If you have not installed the optional 3rd IF 250 Hz filter (or if you disable the filter by *menu selection 5-7*), the received signal will pass through the supplied 2.4 kHz (or optional 500 Hz) filter.

5-5 455-2.0

3rd IF 2.0 kHz Filter - Enables/disables the optional 2.0 kHz IF filter (Yaesu P/N **YF-110SN**).

5-6 455-500

3rd IF 500 Hz Filter - Enables/disables the optional 500 Hz IF filter (Collins **YF-115C**).

5-7 455-250

3rd IF 250 Hz Filter - Enables/disables the optional 250 Hz IF filter (Yaesu P/N **YF-110CN**).

5-8 Sub-FiL

SUB VFO Filter - Enables/disables optional SUB VFO-B 2nd IF 500-Hz CW filter (Collins **YF-115C**).

5-9 t-FiL

TX EDSP Filter - Selects either a 6.0-kHz or 2.4-kHz digital bandpass filter for early-stage transmit audio tailoring.

6-0 rttY-SHF

RTTY Frequency Shift - Selects 170, 425, or 850 Hz standard frequency shift for FSK RTTY operation.

Important Note! - If changing RTTY shift to other than 170 Hz, be sure to re-calibrate the tuning meter as outlined on page 85. The calibration routine is simple, and ensures your center tuning indication matches the tone pair.

6-1 rttY-PoL

RTTY Polarity - Selects normal or reverse Mark/Space polarity for RTTY operation. Normal operation utilizes a 2125-Hz mark frequency, while reverse uses 2295 Hz. See the table on page 17 for a list of standard tone pairs.

6-2 rttY-ton

RTTY Tone - Selects high or low mark tone for RTTY operation. See the table on page 17 for a comparison of high/low tone pairs.

6-3 rtY-FdSP

RTTY Frequency Display - Selects the type of display offset that appears during RTTY operation.

Offset - Displays the RTTY BFO offset.

Carrier - Displays the actual carrier frequency.

6-4 PAc-FdSP

Packet Frequency Display Offset - You can offset the frequency readout to display the center frequency between the two transmitted carriers (tone pairs). Rotate the **MAIN VFO-A** knob to adjust the display offset, or else set to 0.00 to display the actual carrier frequency. See *menu selection 6-5* below for tone pair selection.

6-5 PAc-tonE

Packet Tones - Selects one of four available packet tone pairs (1070/1270Hz, 1600/1800Hz, 2025/2125Hz or 2110/2130Hz). The frequency displayed is actually the center frequency of the selected tone pair. See the table on page 15.

Important Note! - If changing the packet tone pair to other than 2025/2225 Hz, be sure to re-calibrate the tuning meter as outlined on page 85. The calibration routine is simple, and ensures your center tuning indication matches the tone pair.

6-6 (Not Used)

6-7 ctcSS

CTCSS Repeater Tone - Selects one of 33 CTCSS (Continuous Tone Coded Squelch System) tones to be transmitted to access repeaters that require them. By default, 88.5 Hz is enabled.

6-8 tonE SET

Repeater Tone Setting - Selects continuous (CTCSS) tone or burst tone mode for FM repeater operation.

6-9 rPt-SHft

Repeater Shift - Selects the desired TX frequency offset (shift) from the displayed Rx frequency to access repeaters. Standard shift is 100 kHz for 29-MHz FM repeaters.

7-0 keyEr

Keyer Mode Selection - Selects the desired keyer emulation mode for the built-in electronic keyer:

IAMBIC 1 - Iambic keyer with ACS (Automatic Character Spacing) disabled. Weighting is user-selectable via *menu selections 7-1* and *7-2*.

BUG - Mechanical “bug” keyer emulation. One paddle produces “dits” automatically, while the other paddle manually produces “dahs.”

IAMBIC 2 - Iambic keyer with ACS enabled. Weighting is set via *menu selections 7-1* and *7-2*.

7-1 kYr-dot

CW “Dot” Weighting - Adjusts dot character weight from 1 ~ 127 (10 by default, the same size as a “space” within a letter).

7-2 kYr-dSH

CW “Dash” Weighting - Adjusts dash character weight from 1 ~ 127 (30 by default, three times the length of a dot).

7-3 cntSt-no

Contest Keyer ID - Enters the initial 4-digit number that will increment/decrement after sending during contest QSOs.

7-4 bk-in ti

Break-In Time Delay - Selects the time delay from 0 ~ 30 ms (5 ms default) between when the PTT is keyed and the carrier is transmitted during QSK operation when using the internal keyer.

7-5 kYr-dLY

Keyer Delay - Selects the time delay from 0.00 ~ 5.10 seconds (0.00 secs. by default) during which the transmitter remains keyed after you stop sending. This is analogous to “VOX Delay” for the CW mode during non-QSK operation.

Short-cut: Press & hold [FAST] & press [BK-IN].

7-6 A1-StYLE

CW Playback Style (for Contest Number) - Determines the “Cut” number format playback for the CW Contest Number (see menu selection 7-3). The selected number will be played back in “Cut” format (see the chart on page 77).

7-7 dSP-ndn

EDSP Enhanced Modulation & Demodulation - This processes received and transmitted audio at the 4th IF level (10.24 kHz) for enhanced band pass filtering and audio response tailoring. If any setting except “OFF” is selected, the EDSP Modulator or Demodulator will be engaged, bypassing the analog modulator or demodulator.

Four individual EDSP modes are selected with the SUB VFO-B dial, while frequency response choices are adjusted using the MAIN VFO-A dial:

SSB (Rx) - Selects 100 ~ 3100Hz, or 300 ~ 2800Hz filter response, or OFF.

SSB (Tx) - Selects 100 ~ 3100 Hz, 150 ~ 3100 Hz, 200 ~ 3100 Hz, or 300 ~ 3100 Hz filter response, or OFF.

CW (Rx) - Selects 100 ~ 3100 Hz filter response, or OFF.

AM (Rx) - Selects 70 ~ 3800 Hz filter response, or OFF.

7-8 Sub-rcvr

Sub VFO Receiver - Enables or disables the SUB VFO-B receiver from operation. If disabled, you can temporarily turn on the Sub receiver by pressing [DUAL], or the SUB VFO-B RX button/LED.

Menu Selection and Settings

7-9 rc-Func

Remote Control Function - Selects the active feature for remote control operation.

Note - Remote control operation requires a **FH-1** Remote Control Keypad for operation; see the description and charts on pages 76 ~ 79 for details of operation.

Keyer - Activates the contest keyer operation.

Function Keys - Emulate front panel Memory Control keys.

VFO-A - Enables direct-frequency input to VFO-A by emulating the front panel keypad keys.

VFO-B - Enables direct-frequency input to VFO-B by emulating the front panel keypad keys.

If you wish to exercise remote control of the **VL-1000** Linear Amplifier from the **MARK-V FT-1000MP Field**, this menu must be set to "Keyer."

8-0 FAST-SET

FAST Button Operation - Selects front-panel [FAST] button actuation:

Momentary - Press and hold to engage fast tuning.

Continuous - Toggle on/toggle off fast tuning.

8-1 Lock-SEL

LOCK Button Operation - Sets up the panel "Lock" mode:

Dial - Locks MAIN VFO-A knob only.

Panel - Locks front panel buttons & keys (refer to drawing below).

Primary - locks front panel primary function keys (refer to drawing below).

8-2 SPLt-SET

Split Mode Operation - Select one of three split operating modes:

Normal - In this mode, pressing **SUB VFO-B (TX) Switch-LED** activates SUB VFO-B for transmission. Other settings (such as mode and frequency) must be manually set for the Sub VFO.

Auto - When the **SUB VFO-B (TX) Switch/LED** is pressed, SUB VFO-B is enabled for transmit, and the selected operating mode from MAIN VFO-A is automatically copied into SUB VFO-B.

A=B - Same as Auto mode above; however, a pre-set frequency offset is applied to SUB VFO-B for transmission (see *menu selection 1-6*: Quick Split).

8-3 PA-cnt

This menu is fixed, at the factory, to "On."

8-4 FrontEnd

Receiver Front-End RF Amplifier - Selects the desired receiver front-end amplifier configuration:

Flat - A broadband amplifier with flat response.

Tuned - A separate tuned amplifier for the low and high bands.

8-5 Ant-SEL

Antenna Selection - Sets up the rear-panel antenna jack switching:

AUTO - Antenna selections are automatically copied along with other operating parameters during memory programming.

ON - Enables the front panel [ANT] switch.

OFF - Disables the front panel [ANT] switch (only ANT-A is therefore available).

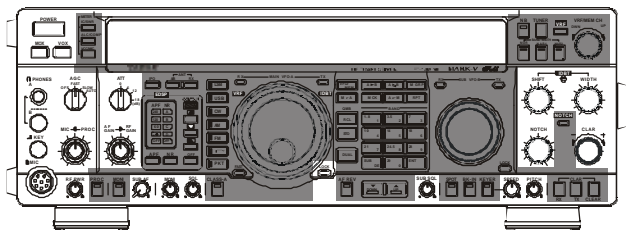

Panel Lock

When the Main VFO (A) [LOCK] button is pressed, all controls within the shaded area (except VRF and IDBT switches) are locked. When the Sub VFO (B) [LOCK] button is pressed, only the SUB VFO Tuning knob is locked.

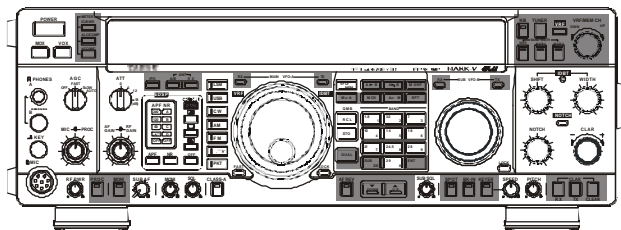

Primary Lock

When the Main VFO (A) [LOCK] button is pressed, only the MAIN VFO Tuning knob is locked. When the Sub VFO (B) [LOCK] button is pressed, all controls within the shaded area are locked.

8-6 uSEr-SEt

User Setting - This configures an operating “environment” selected by pressing and holding in the front-panel [PKT] button. Operating parameters are selected using the Sub VFO knob, while the options are chosen with the Main VFO knob.

Mode - This selects to which mode the custom settings are applied. Choose LSB, USB, CW (normal/reverse), RTTY (normal/reverse), or packet (LSB only).

Display Offset - You can choose a custom offset ± 5.000 kHz (in 5-Hz steps) to take effect when the “USER” mode is activated. The default offset is dependent upon operating mode.

Rx PLL Offset - You can offset the receiver PLL frequency ± 5.000 kHz (in 5-Hz steps) when the “USER” mode is activated.

Rx Carrier - This is used to adjust the receive carrier injection frequency between 450 ~ 460 kHz. The default injection frequency is dependent upon operating mode.

Tx PLL Offset - You can offset the transmitter PLL frequency ± 5.000 kHz (in 5-Hz steps) when the “USER” mode is activated.

Tx Carrier - This is used to adjust the transmit carrier injection frequency between 450.000 ~ 453.700 kHz or 456.300 ~ 460.000 kHz (PKT), 456.300 ~ 460.000 kHz (LSB), 450.000 ~ 453.700 kHz (USB), or between 450.000 ~ 460.000 kHz (all others). The default injection frequency is dependent upon the operating mode.

RTTY Offset (shift) - For operators who desire to use a non-standard mark/space shift (that is, other than 170/425/850 Hz), a custom shift (± 5.000 kHz in 5-Hz steps) can be chosen. The mark is the carrier frequency, while the space is offset above or below the carrier by the value of this setting. For best results, we recommend limiting shift to ± 1.000 kHz or less.

Easy Set - If you enjoy operating FAX, SSTV, or PSK-31, you can select on of these for the User mode. The carrier and offset options for both settings come factory pre-configured and optimized for best operation.

8-7 Sub-AGc

SUB VFO Receiver AGC - Selects automatic, slow, or fast AGC recovery time for the Sub receiver.

8-8 tunEr

Antenna Tuner - Enables or disables the internal automatic antenna tuner unit for operation.

8-9 cAr oFSt

Carrier Point Offset - This allows shifting the carrier point (IF passband) on both Tx and Rx to tailor the received audio response, as well as your transmitted voice audio. This can be used to customize your signal for your own voice characteristics. Seven individual carrier settings are selected with the Sub VFO dial, while offsets are adjusted (in 10-Hz steps) using the Main VFO dial:

Rx LSB Carrier - Adjusts the receiver carrier point for LSB throughout the range of $-200 \sim +500$ Hz.

Tx LSB Carrier - Adjusts the transmitter carrier point for LSB throughout the range of $-200 \sim +500$ Hz.

Processor LSB - Adjusts the speech processor carrier point for LSB throughout the range of $-200 \sim +500$ Hz.

Rx USB Carrier - Adjusts the receiver carrier point for USB throughout the range of $-200 \sim +500$ Hz.

Tx USB Carrier - Adjusts the transmitter carrier point for USB throughout the range of $-200 \sim +500$ Hz.

Processor USB - Adjusts the speech processor carrier point for USB throughout the range of $-200 \sim +500$ Hz.

Tx AM Carrier - Adjusts the transmitter carrier point for AM throughout the range of ± 3000 Hz.

Note: See the table on the next page for a complete list of filter offsets according to mode, and custom frequency and display offsets.

Menu Selection and Settings

Custom Frequency & Display Offset Information (1)

MODE		1st Fc = F + 70.455 BFO (kHz)				
		RX	RX	TX	RX	TX
SSB	LSB	-1500 Hz	-1500 Hz	465.5 kHz	465.5 kHz	
	USB	+1500 Hz	+1500 Hz	453.5 kHz	453.5 kHz	
CW	400 Hz	0	0	454.6 kHz	455.0 kHz	
	500 Hz	0	0	454.5 kHz	455.0 kHz	
	600 Hz	0	0	454.4 kHz	455.0 kHz	
	700 Hz	0	0	454.3 kHz	455.0 kHz	
	800 Hz	0	0	454.2 kHz	455.0 kHz	
CW-R	400 Hz	0	0	454.4 kHz	455.0 kHz	
	500 Hz	0	0	454.5 kHz	455.0 kHz	
	600 Hz	0	0	454.6 kHz	455.0 kHz	
	700 Hz	0	0	454.7 kHz	455.0 kHz	
	800 Hz	0	0	454.8 kHz	455.0 kHz	
AM	Synchronous	0	0	-	455.0 kHz 455.0 kHz	
FM	Narrow	0	0	-	-	
RTTY-L	H 170 Hz	-85.00 Hz	-85.00 Hz	457.2100 kHz	Mark 455.0850 kHz	Space 455.9150 kHz
	H 425 Hz	-212.5 Hz	-212.5 Hz	457.3375 kHz	455.2125 kHz	454.7875 kHz
	H 850 Hz	-425.0 Hz	-425.0 Hz	457.5500 kHz	455.4250 kHz	454.5750 kHz
	L 170 Hz	-850.0 Hz	-850.0 Hz	456.3600 kHz	455.0850 kHz	455.9150 kHz
	L 425 Hz	-212.5 Hz	-212.5 Hz	456.4875 kHz	455.2125 kHz	454.7875 kHz
	L 850 Hz	-425.0 Hz	-425.0 Hz	456.7000 kHz	455.4250 kHz	454.5750 kHz
RTTY-U	H 170 Hz	+85.00 Hz	+85.00 Hz	452.7900 kHz	455.0850 kHz	455.9150 kHz
	H 425 Hz	+212.5 Hz	+212.5 Hz	452.6625 kHz	455.2125 kHz	454.7875 kHz
	H 850 Hz	+425.0 Hz	+425.0 Hz	452.4500 kHz	455.4250 kHz	454.5750 kHz
	L 170 Hz	+850.0 Hz	+850.0 Hz	453.6400 kHz	455.0850 kHz	455.9150 kHz
	L 425 Hz	+212.5 Hz	+212.5 Hz	453.5125 kHz	455.2125 kHz	454.7875 kHz
	L 850 Hz	+425.0 Hz	+425.0 Hz	455.4250 kHz	455.4250 kHz	454.5750 kHz
PKT-L	1170 Hz	0	-330 Hz	456.170 kHz	456.500 kHz	
	1700 Hz	0	0	456.700 kHz	456.700 kHz	
		0	0	457.125 kHz	457.125 kHz	
PKT-F		0	0	457.210 kHz	457.210 kHz	
USER		±5000	±5000	450 ~ 460 kHz	450 ~ 460 kHz	

Menu Selection and Settings

Custom Frequency & Display Offset Information (2)

SELECTED FILTER OFFSETS ACCORDING TO MODE							
MODE		SELECTED FILTER BANDWIDTH					
		6 kHz	2.8 kHz	2.4 kHz	2.0 kHz	500 Hz	250 Hz
SSB	LSB	0	0	- 50 Hz	- 150 Hz	- 500 Hz	- 500 Hz
	USB	0	0	- 50 Hz	- 150 Hz	- 500 Hz	- 500 Hz
CW	400 Hz	+2600 Hz	+1150 Hz	+950 Hz	+650 Hz	0	0
	500 Hz	+2500 Hz	+1050 Hz	+850 Hz	+550 Hz	0	0
	600 Hz	+2400 Hz	+950 Hz	+750 Hz	+450 Hz	0	0
	700 Hz	+2300 Hz	+850 Hz	+650 Hz	+350 Hz	0	0
	800 Hz	+2200 Hz	+750 Hz	+550 Hz	+250 Hz	0	0
CW-R	400 Hz	+2600 Hz	+1150 Hz	+450 Hz	+650 Hz	0	0
	500 Hz	+2500 Hz	+1050 Hz	+350 Hz	+550 Hz	0	0
	600 Hz	+2400 Hz	+950 Hz	+250 Hz	+450 Hz	0	0
	700 Hz	+2300 Hz	+850 Hz	+650 Hz	+350 Hz	0	0
	800 Hz	+2200 Hz	+750 Hz	+550 Hz	+250 Hz	0	0
AM	Synchronous	±2800 Hz	±1200 Hz	±1000 Hz	±800 Hz	±150 Hz	±70 Hz
FM	Narrow	0	-	-	-	-	-
RTTY-L	H 170 Hz	+800 Hz	0	0	0	0	0
	H 425 Hz	+600 Hz	0	0	0	0	0
	H 850 Hz	+450 Hz	0	0	0	0	0
	L 170 Hz	+1640 Hz	0	0	0	0	0
	L 425 Hz	+1520 Hz	0	0	0	0	0
	L 850 Hz	+1300 Hz	0	0	0	0	0
RTTY-U	H 170 Hz	+800 Hz	0	0	0	0	0
	H 425 Hz	+600 Hz	0	0	0	0	0
	H 850 Hz	+450 Hz	0	0	0	0	0
	L 170 Hz	+1640 Hz	0	0	0	0	0
	L 425 Hz	+1520 Hz	0	0	0	0	0
	L 850 Hz	+1300 Hz	0	0	0	0	0
PKT-L	1170 Hz	+1850 Hz	0	0	0	0	0
	1700 Hz	+1300 Hz	0	0	0	0	0
	2125 Hz	+900 Hz	0	0	0	0	0
	2210 Hz	+800 Hz	0	0	0	0	0
PKT-F	0	0					
USER							

Menu Selection and Settings

Menu Selection Setting Table

Func No.	Function	Setting Range	Default
0-1	Memory Group 1 Channels	1 ~ 99	01 ~ 99
0-2	Memory Group 2 Channels	0 ~ 99	OFF
0-3	Memory Group 3 Channels	0 ~ 99	OFF
0-4	Memory Group 4 Channels	0 ~ 99	OFF
0-5	Memory Group 5 Channels	0 ~ 99	OFF
0-6	Quick Memory Channel Banks	1 ~ 5	5
0-7	–	–	–
0-8	[A▶B] Auto Channel Up	ON/OFF	OFF
0-9	EDSP	ON/OFF	ON
1-0	VFO-A & VFO-B Dial Speed	2/4	4
1-1	Shuttle Jog Dial Speed	1 mS ~ 100 mS	50 mS
1-2	IF SHIFT/WIDTH Step Size	10/20 Hz	10 Hz
1-3	Main VFO-A Tuning Step Size	0.62(5)/1.25/2.50/5.00/10.00/20.00Hz	10.00 Hz
1-4	SUB VFO-B Tuning Step Size	0.62(5)/1.25/2.50/5.00/10.00/20.00Hz	10.00 Hz
1-5	Channel Step Size	1 ~ 100 kHz	10 kHz
1-6	Quick Split Offset	(±) 1 ~ 100 kHz	5 kHz
1-7	Automatic Selection of the AGC Decay Time	ON/OFF	OFF
1-8	CLAR M-Tune Function	ON/OFF	ON
1-9	CLAR Tuning Step Size	0.62(5)/1.25/2.50/5.00/10.00/20.00Hz	10.00 Hz
2-0	Scan Pause	ON/OFF	ON
2-1	Scan Resume Mode	CAR STOP/CAR TIME/CAR SLOW	CAR STOP
2-2	–	–	–
2-3	Memory Scan Speed (Dwell Time)	100 mS ~ 1000 mS (1S)	200 mS
2-4	VFO Scan Speed (Dwell Time)	1 mS ~ 100 mS	10 mS
2-5	Auto Memory Write	OFF/GROUP x/ GROUPS ALL	OFF
2-6	Memory Scan Skip	OFF/OFF	OFF
2-7	Scan Delay Time	1 S ~ 10 S	5 S
2-8	Noise Blanker	A1 ~ A15 & B1 ~ B15	A12
2-9	NOTCH Mode	IF NOTCH/AUTO DSP/SELECT	IF NOTCH
3-0	Frequency Display	OFFSET/CARRIER	OFFSET
3-1	Display Resolution	10 Hz/100 Hz/1000 Hz (1 kHz)	10 Hz
3-2	ETS (Enhanced Tuning Scale)	CLAR/DIAL	CLAR
3-3	Transverter Frequency Display	OFF/50/144/430	OFF
3-4	Dimmer (Display Brightness)	LOW/HI	HI
3-5	Panel Display Mode	CLAR/CH FREQ/OFFSET/CW PITCH	CLAR
3-6	SUB VFO-B S-Meter	ON/OFF	ON
3-7	MAIN VFO-A Meter Peak-Hold	OFF/10 mS ~ 2000 mS (2S)	OFF
3-8	SUB VFO-B Meter Peak-Hold	OFF/10 mS ~ 2000 mS (2S)	OFF
3-9	–	–	–
4-0	RF Output Power (Limit)	Hi (100 W) / Lo-2 (25W) / Lo-1(10 W)	Hi (100 W)
4-1	Key & Panel Beeper	ON/OFF	ON

Menu Selection and Settings

Menu Selection Setting Table (Cont.)

Func No.	Function	Setting Range	Default
4-2	Key & Panel Beep Pitch	220Hz ~ 7040 Hz or BEEP TUN ON/OFF	880 Hz
4-3	Tuning Drive (Auto Power-Down)	Lo-1(10 W) / Lo-2 (25W) / Hi (100 W)	Lo-2 (25W)
4-4	TX Audio EDSP	OFF/1/2/3/4	OFF
4-5	–	–	–
4-6	DVS RX Recording	MAIN VFO-A/SUB VFO-B	MAIN VFO-A
4-7	DVS PTT Control	ON/OFF	ON
4-8	Headphone Audio	MONO/STEREO 1/STEREO 2	STEREO 1
4-9	AF GAIN Balance Control	SEPARATE/BALANCE	SEPARATE
5-0	SSB Normal Filter	8.2/455/8.2-455/OFF	OFF
5-1	2nd IF (8.2 MHz) 2.0 kHz Filter	ON/OFF	OFF
5-2	CW Narrow Filter	8.2/455/8.2-455	8.2-455
5-3	2nd IF (8.2 MHz) 250 Hz Filter	ON/OFF	OFF
5-4	DATA Narrow Filter	8.2/455/8.2-455	8.2-455
5-5	3rd IF (455 kHz) 2.0 kHz Filter	ON/OFF	OFF
5-6	3rd IF (455 kHz) 500 kHz Filter	ON/OFF	OFF
5-7	3rd IF (455 kHz) 250 kHz Filter	ON/OFF	OFF
5-8	SUB VFO-B RX Filter	ON/OFF	OFF
5-9	TX EDSP Filter	6.0 kHz/2.4 kHz	6.0 kHz
6-0	RTTY Shift	170/425/850 Hz	170 Hz
6-1	RTTY Polarity	NORMAL/REVERSE	NORMAL
6-2	RTTY Tone Pair	HIGH TONE/LOW TONE	HIGH TONE
6-3	RTTY Frequency Display	CARRIER/OFFSET	OFFSET
6-4	Packet Frequency Display	±3.000 kHz	-2.125 kHz
6-5	Packet Tone Frequency	1170 Hz/1700 Hz/2125 Hz/2210 Hz	2125 Hz
6-6	–	–	–
6-7	CTCSS Tone Select	67.0 Hz ~ 250.3 Hz	88.5 Hz
6-8	Tone Mode	CONTINUOUS/BURST	CONTINUOUS
6-9	Repeater Shift (TX OFFSET)	0 ~ 200 kHz	100 kHz
7-0	Electronic Keyer Mode	IAMBIC 1/BUG/IAMBIC 2	IAMBIC 1
7-1	Keyer Dot Weighting	0 (1:0.5) ~ 127 (1:2.0)	10 (1:1.0)
7-2	Keyer Dash Weighting	0 (1:2.0) ~ 127 (1:4.5)	30 (1:3.0)
7-3	Keyer Contest Number	0000 ~ 9999	0000
7-4	Keyer Break-in Time	0 mS ~ 30 mS	5 mS
7-5	Keyer Delay Time	0.00 S ~ 5.10 S	0.00 S
7-6	CW Playback Style	–	–
7-7	EDSP Modulation & Demodulation	SSB (RX): 100 - 3100 Hz/300 - 2800 Hz/ OFF SSB (TX): 100 - 3100 Hz/150 - 3100 Hz/ 200 - 3100 Hz/300 - 3100 Hz/ OFF CW (RX) 100 - 3100 Hz/OFF AM (RX) 70 - 3800 Hz/OFF	OFF OFF OFF OFF
7-8	Sub Receiver	ON/OFF	ON
7-9	Remote Control Function	KEYER/FRONT KEY/VFO-A/VFO-B	KEYER

Menu Selection and Settings

Menu Selection Setting Table (Cont.)

Func No.	Function	Setting Range	Default
8-0	[FAST] key Operation	CONTINUOUS/TOGGLE	TOGGLE
8-1	LOCK Selection	DIAL/PANEL/PRIMARY	DIAL
8-2	Split Operation	NORM/AUTO/A=B	NORM
8-3	Power Amplifier	ON/OFF	Always "ON"
8-4	Frontend RF AMP Selection	TUNED/FLAT	FLAT
8-5	[ANT] Key Function	AUTO/ON/OFF	AUTO
8-6	USER Setting MODE Display Offset Receiver PLL Receiver Carrier Transmit PLL Transmit Carrier RTTY Offset Easy Set	LSB/USB/CW(L&U)/RTTY(L&U)/PKT ±5.000 kHz ±5.000 kHz 450.000 kHz ~ 460.00 kHz ±5.000 kHz LSB: 456.300 kHz ~ 460.000 kHz USB: 450.000 kHz ~ 453.700 kHz PKT: 450.000 kHz ~ 453.700 kHz or 456.300 kHz ~ 460.000 kHz all others: 450.000 ~ 460.000 kHz ±5.000 kHz OFF/SSTV/FAX/PSK-31*1	LSB See Table Below See Table Below See Table Below See Table Below See Table Below See Table Below OFF
8-7	SUB RX AGC	AUTO/SLOW/FAST	AUTO
8-8	TUNER	ON/OFF	ON
8-9	Carrier Offset RX LSB Carrier TX LSB Carrier PROC. LSB Carrier RX USB Carrier TX USB Carrier PROC. USB Carrier TX AM Carrier	- 0.200 kHz ~ +0.500 kHz - 0.200 kHz ~ +0.500 kHz - 0.200 kHz ~ +0.500 kHz - 0.200 kHz ~ +0.500 kHz - 0.200 kHz ~ +0.500 kHz - 0.200 kHz ~ +0.500 kHz - 0.200 kHz ~ +0.500 kHz	0.000 kHz 0.000 kHz 0.000 kHz 0.000 kHz 0.000 kHz 0.000 kHz 0.000 kHz

*1: See Table on Next Page

Default USER Function Settings

	LSB	USB	CW (USB)	CW (LSB)	RTTY (LSB)	RTTY (USB)	PKT (LSB)
Display Offset	0.000 kHz	0.000 kHz	0.600 kHz	- 0.600 kHz	- 2.125 kHz	2.125 kHz	- 2.125 kHz
Receiver PLL	- 1.450 kHz	1.450 kHz	0.600 kHz	- 0.600 kHz	- 2.210 kHz	2.210 kHz	- 2.210 kHz
Receiver Carrier	456.450 kHz	453.550 kHz	454.400 kHz	455.600 kHz	457.210 kHz	452.790 kHz	457.120 kHz
Transmit PLL	- 1.500 kHz	1.500 kHz	0.600 kHz	- 0.600 kHz	- 2.125 kHz	2.125 kHz	- 2.120 kHz
Transmit Carrier	456.500 kHz	453.500 kHz	455.000 kHz	455.000 kHz	455.000 kHz	455.000 kHz	457.120 kHz
RTTY Offset	0.000 kHz	0.000 kHz	0.000 kHz	0.000 kHz	- 0.170 kHz	0.170 kHz	0.000 kHz

Menu Selection and Settings

Easy Set Mode Settings

Easy Set	Mode	Display Offset	RX PLL	RX Carrier	TX PLL	TX Carrier
SStv-L	PKT-L	0.000 kHz	-1.750 kHz	456.750 kHz	-1.750 kHz	456.750 kHz
SStv-U	PKT-L	0.000 kHz	1.750 kHz	453.250 kHz	1.750 kHz	453.250 kHz
FAcS-L	PKT-L	0.000 kHz	-1.900 kHz	456.900 kHz	-1.900 kHz	456.900 kHz
FAcS-U	PKT-L	0.000 kHz	1.900 kHz	453.100 kHz	1.900 kHz	453.100 kHz
PS31-L	PKT-L	-1.000 kHz	-1.000 kHz	456.000 kHz	-1.500 kHz	456.500 kHz
PS31-U	PKT-L	1.000 kHz	1.000 kHz	454.000 kHz	1.500 kHz	453.500 kHz
PS31-SL	LSB	-1.000 kHz	-1.450 kHz	456.450 kHz	-1.500 kHz	456.500 kHz
PS31-SU	USB	1.000 kHz	1.450 kHz	453.550 kHz	1.500 kHz	453.500 kHz

Installing Internal Accessories

This section contains the installation procedures for installable options available for the **MARK-V FT-100MP Field**. A complete list of options and their corresponding Yaesu P/N is provided on pages 5 and 6 of this manual. Please check with your dealer for pricing and availability.

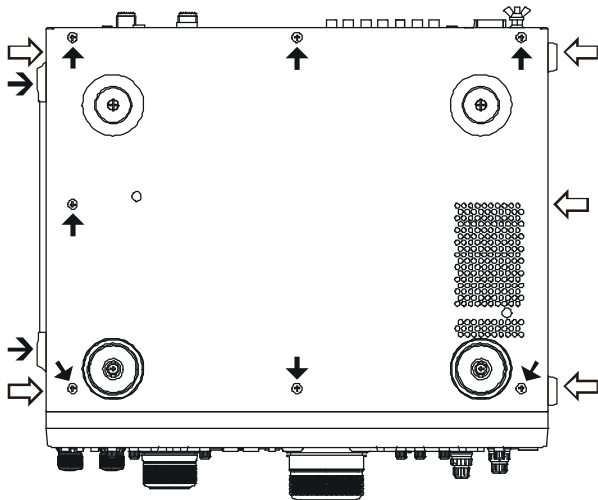

Figure 1

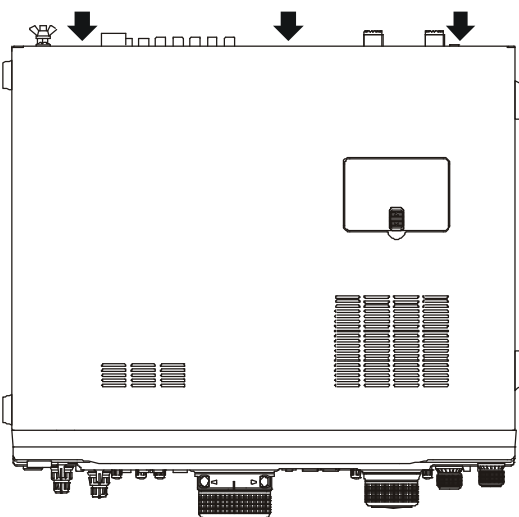
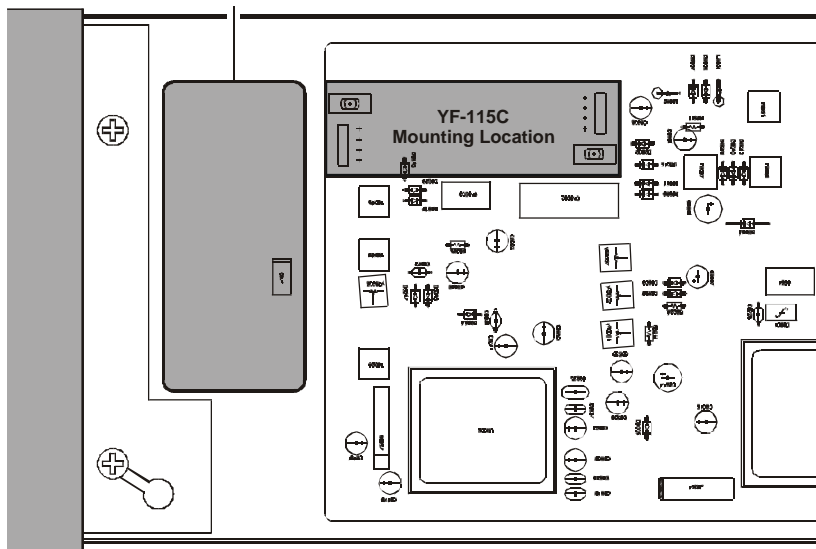

Figure 2

TCXO-6 Mounting Location
(Replace with the factory-installed TCXO Unit)



TCXO UNIT

The Temperature-Compensated Crystal Oscillator is the heart of the master reference oscillator used throughout the transceiver. An optional TCXO unit is available for installation into the **MARK-V FT-100MP Field**. The ± 0.25 -ppm **TCXO-6** replaces the factory-installed TCXO unit, and it provides enhanced frequency stability compared to the standard ± 0.5 -ppm module.

If you also have the optional **YF-115C** Sub Receiver filter, now would be a good time to install it, as its mounting position is also exposed during the TCXO installation procedures.

TCXO-6 Installation

- Disconnect all cables from the transceiver.
- Referring to Figure 1, remove the carrying handle and its two screws (\rightarrow), then remove the four screws (\Leftrightarrow) on each side of the transceiver, and the seven screws (\rightarrow) from the bottom of the transceiver, then lift off the bottom cover.
- Referring to Figure 2, remove the three screws (\blacktriangleright) along the top edge of the rear panel, then lift off the top cover.
- Locate the factory-installed TCXO UNIT in the front right corner of the chassis (see drawing below), and remove the wiring connector from the board. Use a small screwdriver to pry up the rear edge of the connector, and avoid pulling on the wires.
- Remove the four screws at the corners of the board, and remove the factory-installed TCXO UNIT.
- Position the new **TCXO-6** in place, and use the same screws just removed to affix the new board in place.
- Reinstall the wiring connector.

This completes the installation; replace the covers and carrying handle with its screws removed above (unless installing other options now).

Installing Internal Accessories

MAIN RECEIVER 2ND AND 3RD IF FILTERS

A total of 5 optional crystal IF filter units can be installed in addition to the factory-installed filters (see the table). Contact your dealer for pricing, availability and ordering. These filters include small boards with connectors, so no soldering is necessary for their installation.

Important! After filter installation, front-panel selection is not possible until individual filters are enabled via menu programming (*menu selection 5-0 ~ 5-8*). Refer to the Menu Programming chapter and enable the optional filters after installing them.

Filter Installation

- ❑ Disconnect all cables from the transceiver.
- ❑ Referring to Figure 1, remove the carrying handle and its two screws (➔), then remove the four screws (⇔) on each side of the transceiver, and the seven screws (➔) from the bottom of the transceiver, then lift off the bottom cover.
- ❑ Referring to Figure 2, remove the three screws (➡) along the top edge of the rear panel, then lift off the top cover.
- ❑ On the underside of the transceiver chassis, locate the IF UNIT. Referring to the drawing below, determine the location of the filter(s) you are installing.
- ❑ Position each filter so that its connectors are aligned with the mounting pins on the board, and push it into place, so the nylon mounting tabs “mushroom” through the holes and lock the unit in place.
- ❑ Connect the speaker cable to the speaker on the top cover, then replace the all covers and screws (unless installing other options now). Refer to pages 101 and 102 of the Menu Programming chapter to enable newly-installed filters.

SUB RECEIVER CW NARROW FILTER

The optional **YF-115C** Collins mechanical filter (500 Hz BW) is available for the 455-kHz Sub Receiver 3rd IF for enhanced reception. Only top cover removal is required for installation.

Installation

- ❑ Disconnect all cables from the transceiver.
- ❑ Referring to Figure 1, remove the carrying handle and its two screws (➔), then remove the four screws (⇔) on each side of the transceiver, and the seven screws (➔) from the bottom of the transceiver, then lift off the bottom cover.
- ❑ Referring to Figure 2, remove the three screws (➡) along the top edge of the rear panel, then lift off the top cover.
- ❑ Locate the SUB RX Unit on the right side of the set.
- ❑ Referring to the photograph on page 112, determine the location of the Sub Rx filter you are installing.
- ❑ Position the filter so that its connectors are aligned with the mounting pins on the board, and push it into place, so the nylon mounting tabs “mushroom” through the hole and lock the unit in place.
- ❑ Connect the speaker cable to the speaker on the top cover, then replace the all covers and screws, unless installing the **YF-115C** options now. Refer to the Menu Programming chapter to enable the newly-installed filter (*menu selection 5-8*).

Optional IF Filter Units			
8.2 MHz 2nd IF		455 kHz 3rd IF	
Yaesu P/N	B/W	Yaesu P/N	B/W
YF-114SN	2.0 kHz	YF-110SN	2.0 kHz
YF-114CN	250 Hz	YF-115C*	500 Hz
—	—	YF-110CN	250 Hz

*: Collins Mechanical Filter

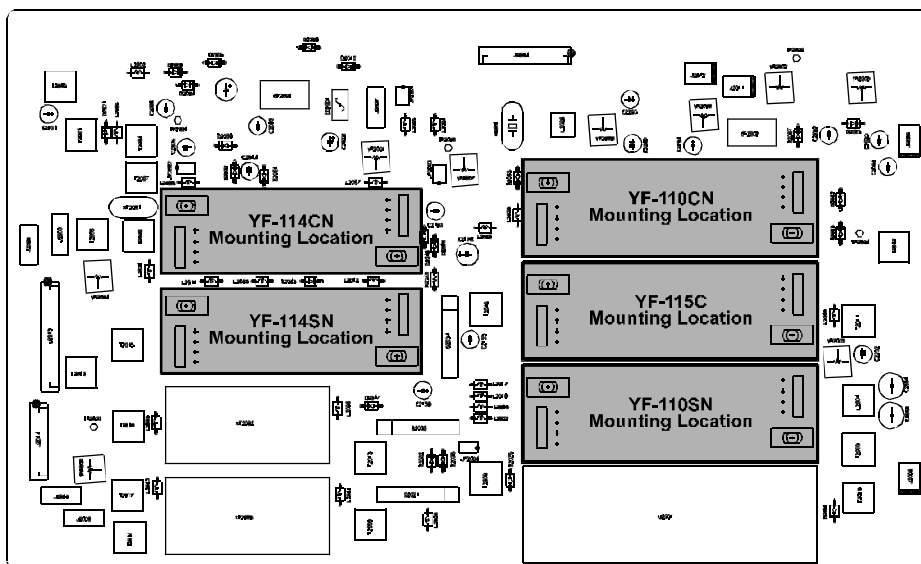

LITHIUM BATTERY REPLACEMENT

A 3-V Type CR2032 Lithium Battery (**BT5001**) is located on the CNTL UNIT board (underside) of the transceiver. This maintains the memorized data in your radio. Battery life is normally greater than five years, however, should replacement be needed, perform the following steps:

With the carrying handle and top and bottom covers removed, note the location of the battery. Using your finger, slide the battery inward (you will feel slight pressure by the mounting spring), then slightly pry it up and outward so that it ejects freely through the slots in the battery holder.

Carefully note battery polarity with the positive (+) side facing upward, and battery-type information. Install the replacement battery in the reverse manner.

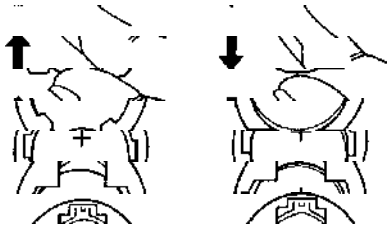

MEMORY BACK-UP SWITCH

The rear panel memory **BACKUP** switch is normally kept in the “**ON**” position to ensure your memorized data is maintained (by a small amount of power from the lithium battery) when the radio is off, or the DC power source is removed.

- If you do not plan to operate your radio for extended periods of time, slide this switch to the “**OFF**” position to conserve battery life.
- Ensure the radio is on when sliding the switch back to the “**ON**” position, as this reduces the initial current demand on the battery by the radio’s circuits from an un-powered state.

Note: Memorized settings are lost and the radio returns to factory default settings when turning off the backup battery.

CAUTION

Danger of explosion if battery is incorrectly replaced. Replace only with the same or equivalent type.

POWER-ON MICROPROCESSOR RESET PROCEDURES

Some or all transceiver settings can be reset to their factory-default states using one of the following power-on routines:

- [29(0)] + POWER** on: Resets all menu setting to factory-default.
- [SUB(CE)] + [ENT] + POWER** on: Resets all memories (except menu setting) to factory-default.
- [SUB(CE)] + [29(0)] + [ENT] + POWER** on: CPU master reset for all memories and menu setting.

CHANGING THE AC INPUT VOLTAGE SELECTOR SWITCH (U.S.A. USER ONLY)

- ❑ Make certain that all cables are disconnected from the transceiver.
- ❑ Wait 10 minutes to allow the power supply's electrolytic capacitors to discharge (electrical shock hazard!).
- ❑ Remove the carrying handle and its two screws (→), then remove the four screws (⇔) on each side of the transceiver and the three screws (→) along the top edge of the rear panel, then lift off the top cover.

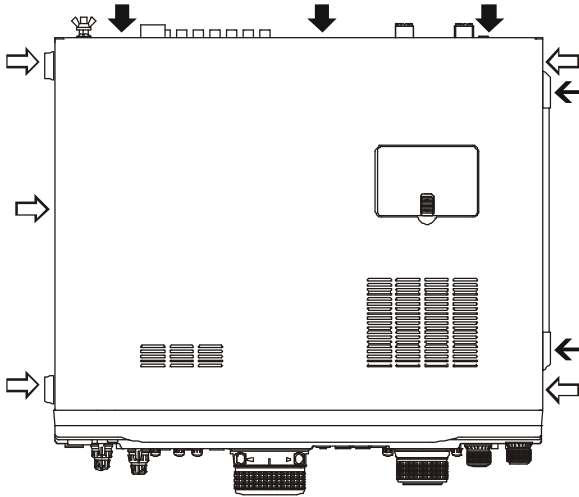

- ❑ Locate the Voltage Selector Switch on the Power Supply Unit in the transceiver's chassis. Move the Voltage Selector Switch to appropriate mains voltage for your country (either 230 V or 115 V).

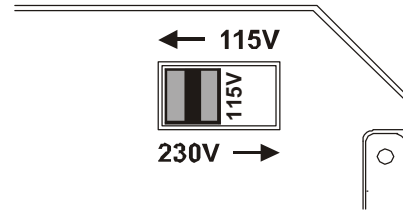

- ❑ Replace the top cover and its 11 screws, then replace the carrying handle and its two screws.
- ❑ Change the fuse in the fuse holder on the rear panel, as indicated below. Do not use slow blow type fuses.

AC MAIN VOLTAGE	AC FUSE RATING
100 - 120 V	8 A
200 - 240 V	4 A

Also, change the voltage marking on the label on the rear panel to match the new voltage setting.

- ❑ Completes the voltage change procedure.



Our Warranty does not cover damage caused by improper supply voltage nor use of an improper fuse.



**Copyright 2002
VERTEX STANDARD CO., LTD.
All rights reserved.**

**No portion of this manual
may be reproduced without
the permission of
VERTEX STANDARD CO., LTD.**

0202Y-0K

