

# ALINCO

## VHF/UHF DUAL BAND FM TRANSCEIVER

# DJ-V5T/E

## Instruction Manual

Thank you for buying this ALINCO transceiver. This instruction manual contains important safety and operating instructions. Please read it carefully before using the transceiver.

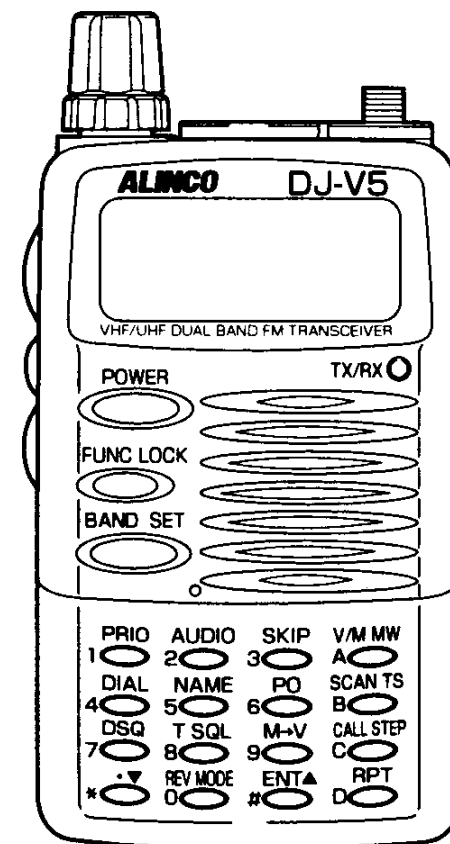

## NOTICE

This equipment has been tested and found to comply with the limits for a Class B digital device, pursuant to part 15 of the FCC Rules. These limits are designed to provide reasonable protection against harmful interference in a residential installation. This equipment generates, uses, and can radiate radio frequency energy and, if not installed and used in accordance with the instruction manual, may cause harmful interference to radio communications. However, there is no guarantee that interference will not occur in a particular installation. If this equipment does cause harmful interference to radio or television reception, which can be determined by turning the equipment off and on, the user is encouraged to try to correct the interference by one or more of the following measures:

- Reorient or relocate the receiving antenna.
- Increase the separation between the equipment and receiver.
- Connect the equipment into an outlet on a circuit different from that to which the receiver is connected.
- Consult the dealer or an experienced radio/TV technician for help.



Tested to Comply  
With FCC Standards

### FOR HOME OR OFFICE USE

Information in this document are subject to change without notice or obligation. All brand names and trademarks are the property of their respective owners. Alinco cannot be liable for pictorial or typographical inaccuracies. Some parts, options and/or accessories are unavailable in certain areas. Changes or modifications not expressly approved by the party responsible for compliance could void the user's authority to operate the equipment.

Copyright© 1998 All rights reserved. No part of this document may be reproduced, copied, translated or transcribed in any form or by any means without the prior written permission of Alinco, Inc., Osaka, Japan.  
English Edition Printed in Japan.

## Precautions

### CAUTION



Do not open the transceiver case or touch non-user-serviceable components.



Do not yank the power cord from its outlets. Also, do not rewire the power cord with other extension cords. Such handling may damage or short-circuit the cord.



Do not expose the product to direct sunlight or heat sources. Also, avoid using the product in an extremely dusty or humid environment.



Use a 13.8 V DC regulated power supply to operate this product. The transceiver must be grounded.



Do not place anything, which might spill on top of or over the product.



Beware of moisture condensation. Moisture in the air will condense on the product when you move it from a cold place to a warm place. Condensation will cause the unit to malfunction. If condensation forms on the unit, wipe or let dry.

# Contents

Contents .....	2
■ Before operating the transceiver .....	4
● Attention .....	4
● Points to Note Before Transmitting .....	4
● Points to Note for Using an External Power Supply .....	4
■ Accessories .....	5
● Open the Box and Check That the Following Items Have Been Included .....	5
● Connecting and Disconnecting the Antenna .....	5
● Attaching the Hand Strap .....	5
● Attaching and Detaching the Belt Clip .....	5
● Attaching and Detaching the Ni-Cd Battery Pack and Battery Case .....	5
● Loading Batteries .....	6
● Exchanging the Batteries .....	6
● Battery Recharger (EDC-93, EDC-94) .....	6
● 6.0V-700mAh Ni-Cd Battery Pack (EBP-45N) .....	7
● Prevent Short Circuiting the Ni-Cd Battery Pack .....	7
1 Names and Functions of Parts .....	8
1-1 External View .....	8
■ Front .....	8
■ Top .....	8
■ Side .....	9
■ Rear .....	9
1-2 Keyboard .....	10
■ Upper Part .....	10
■ Lower Part .....	11
1-3 Display .....	12
2 Basic Operation .....	13
2-1 Basic Operation .....	13
■ Turning the Power On .....	13
● Voltage Indication .....	13
■ Adjusting the Audio Volume .....	13
■ Squelch .....	13
● Adjusting the Squelch .....	13
■ Monitor Function and Squelch Level .....	14
● Switching MONI-1 and MONI-2 .....	14
2-2 Operating Modes .....	15
■ VFO Mode .....	15
■ Memory Mode .....	15
■ Call Mode .....	15
■ Switching Between Modes .....	15
2-3 Setting the Frequency in the VFO Mode .....	16
■ Switching the Band .....	16
■ Adjusting the Frequency in Tuning Steps .....	16
● Setting the Tuning Step .....	17
■ Adjusting in 1 MHz Steps .....	17
■ Entry From the Keyboard .....	18
■ First Entry Digit for Different Tuning Steps .....	18
2-4 Receiving .....	19
■ Setting the Receiving Mode .....	19
2-5 Transmitting .....	20
■ Setting Transmission Output Level .....	20
3 Memory Channel and Call Channel .....	21
3-1 Memory (MR) Channel .....	21
■ Selecting a Memory Channel Number .....	21
■ Programming a Memory Channel .....	21
● Memory Channel Programming .....	21
● Programmed-Scan Channel Programming .....	22
● Call-Channel Programming .....	22
■ Calling up a Programmed Memory Channel Number .....	22
■ Clearing a Memory Channel .....	22
■ Setting the Memory Channel Skip .....	23
■ Memory Shift .....	23
3-2 Call Channel .....	24
■ Selecting a Call Channel .....	24
■ Programming a Call Channel .....	24
4 Functions .....	25
4-1 Scan Modes .....	25
■ Band Scan and Programmed Scan .....	25
■ Memory Scan and Skip Scan .....	26

■ Common Function of All Scans .....	27	■ Communicating Using DSQ Code .....	38
■ Setting Scan Resume Conditions.....	27	■ Attention When Using DSQ.....	39
■ Scan Operation When Setting Tone Squelch and DTMF Squelch.....	28	5-3 Auto Dialer.....	39
4-2 Priority Watch.....	28	■ Programing Dial Codes .....	39
■ Turning Priority Watch On.....	28	■ Clearing the Dial Code .....	40
■ Simultaneous Operation of Priority Watch and Scans .....	29	■ Sending the Auto Dialer Code.....	40
● Stopping Scanning Only.....	29	■ Outputting DTMF Codes Manually .....	40
● Stopping Priority Watch Only .....	29	6 Maintenance and Reference .....	41
4-3 Repeater Operation .....	30	■ Troubleshooting.....	41
■ Repeater Shift .....	30	■ Resetting .....	42
■ Reverse .....	30	■ Factory Settings.....	42
■ Tone Burst .....	31	■ Options .....	43
4-4 Mode Settings .....	31	● Reference of EMS-8 (Remote control speaker microphone) .....	43
■ Beep Function.....	31	● A Key Function Allocation .....	43
■ Bell .....	32	■ Packet Operation .....	44
■ Auto Power Off (APO).....	32	● Packet Operation Connections .....	44
■ Battery Save (BS).....	32	■ Cloning .....	44
■ Setting the DTMF Transmission Delay Time .....	32	■ Transmission System.....	46
■ Split.....	33	■ Specifications .....	47
4-5 Other Functions.....	33		
■ Display Choices.....	33		
● Frequency Display.....	33		
● Channel Display .....	33		
● Switching Between the Frequency Display and Channel Display .....	33		
■ Naming Memory Channels .....	34		
■ Setting the Audio Modulation .....	35		
■ Keylock.....	35		
■ Lamp.....	35		
5 Communicating .....	36		
5-1 Tone Squelch Frequency (CTCSS).....	36		
■ Setting Tone Encoder Frequency .....	36		
■ Setting Tone Squelch Frequency.....	37		
■ Transmitting and Receiving with a Tone Frequency .....	37		
5-2 DTMF Squelch (DSQ).....	38		
■ Setting DSQ Code .....	38		

## ■ Before operating the transceiver

### ● Attention

- Do not remove the case or touch the interior components. Tampering can cause equipment trouble.
- Do not use or keep the transceiver where it is exposed to direct sunlight, dusty places, or near sources of heat.
- Keep the transceiver away from TVs, tuners or other equipment when it interferes with reception.
- Securely connect the antenna which has been included with the transceiver.
- For external power, Alinco recommends using the EDC-34 cigarette lighter cable with filter.
- When transmitting for a long time at high power, the transceiver can overheat.
- Turn the power off immediately if the transceiver emits smoke or strange odors. Ensure the transceiver is safe, then bring it to the nearest Alinco service center.

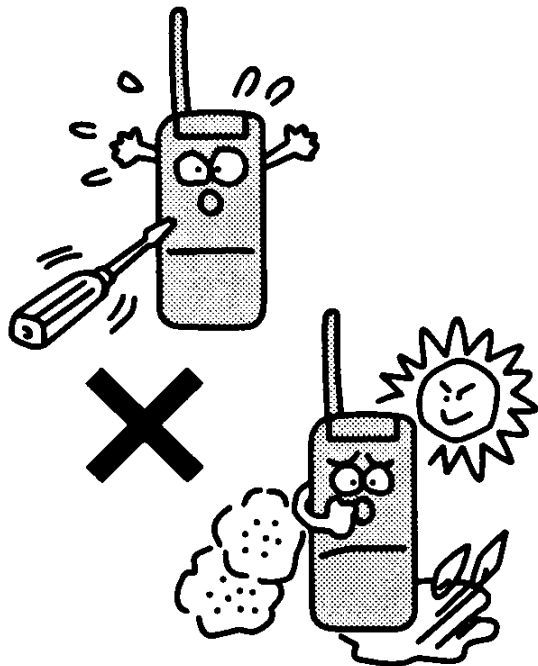

### ● Points to Note Before Transmitting

Many wireless stations use frequencies adjacent to the ham bands for business purposes. Be mindful when transmitting near them. Even when amateur stations obey radio laws, unexpected jamming can occur.

Pay sufficient attention during mobile operation.

**⚠ Caution: Depending on laws in different region, it may be forbidden to use the transceiver in the following places:**

- Aboard aircraft
- In airports
- In ports
- Within or near the operating area of business wireless stations or their relay stations

**Before use in any of the above places, obtain any necessary permission from the proper authorities, and be mindful of local laws that govern amateur radio operation.**

### ● Points to Note for Using an External Power Supply

- Use a 4.0 V-15.0 DC power supply as an external power supply.
- When connecting the power supply to the transceiver, use an optional DC cable for base station (EDC-37). Connect the cable to the DC jack on the side of the transceiver.
- When the power is supplied from a cigarette socket of a car, use the cigarette lighter cable (EDC-43) or the cigarette lighter cable with filter (EDC-36). Use the cigarette lighter cable with filter (EDC-36) during mobil operation to prevent noise.
- Turn the power off when connecting or disconnecting the DC cable.

## ■ Accessories

### ● Open the Box and Check That the Following Items Have Been Included:

- Antenna
- Belt clips
- Hand Strap
- Battery Recharger (EDC-93(120V), EDC-94(230V)) \*
- Ni-Cd battery pack 6.0V — 700mAh (EBP-45N) \*
- Instruction manual
- Warranty \*
- Cautions about PL

\*Standard Accessories May Differ Depending On The Version

### ● Connecting and Disconnecting the Antenna

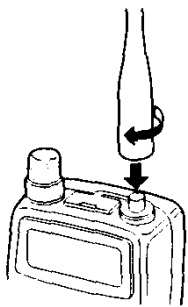

1. Hold the antenna by its base.
2. Align the grooves at the base of the antenna with the protrusions on the antenna connector.
3. Slide the antenna down and turn it clockwise until it stops.
4. Confirm that the antenna is securely connected.

- Turn the antenna counter-clockwise to disconnect the antenna.

### ● Attaching the Hand Strap

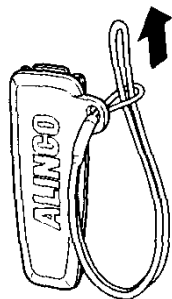

Attach the hand strap as shown in the illustration on the left.

### ● Attaching and Detaching the Belt Clip

- Attaching the Belt Clip  
Attach the belt clip to the back of the transceiver until it clicks.
- Detaching the Belt Clip  
Push up the catches of the belt clip, and pull it.

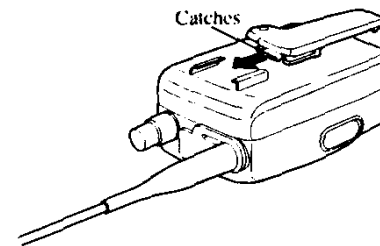

Attaching

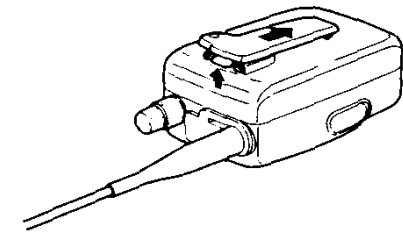

Detaching

### ● Attaching and Detaching the Ni-Cd Battery Pack and Battery Case

- Attaching the Ni-Cd battery pack or battery case:  
Align with the grooves on the transceiver, and slide in the direction of the arrow until it clicks.

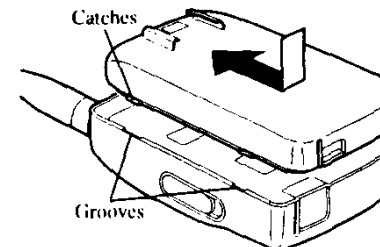

Attaching

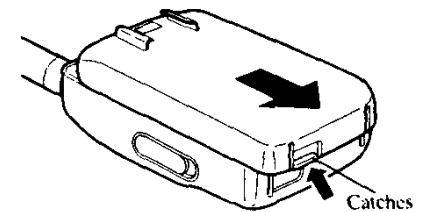

Detaching

- Detaching the Ni-Cd battery pack or battery case:  
Push up the catches, and pull the battery pack or case free of the transceiver.

## ● Loading Batteries

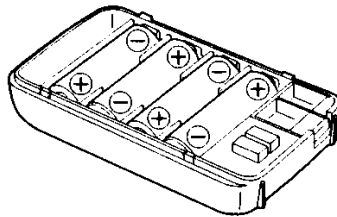
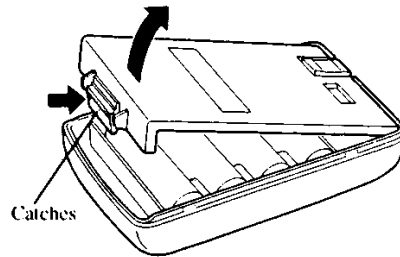

- 1.** Release the catches on the battery case, and lift the battery case up and off.
- 2.** Load four commercially available AA alkaline batteries.
- 3.** Set the batteries in the battery case in the  $\oplus \ominus$  orientation marked at the bottom of the case.
- 4.** Fit the catches at end of the battery case.
- 5.** Push the battery case until it clicks into place.

*Note :*      **Do not use AA Ni-Cd batteries on the market.**

## ● Exchanging the Batteries

Use new batteries of the same type (e.g. : alkaline) and brand.  
The DJ-V5 is a high output transceiver.  
Alkaline batteries are recommended for use over extended periods of time.

*Reference:*      · *Auto Power Off (page 32), Battery Save ( page 32)*  
                          *These functions extend battery life.*

## ● Battery Recharger (EDC-93(120V), EDC-94(230V))

· Recharging with the EDC-93(120V), EDC-94(230V)

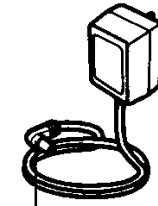

AC adapter plug

- 1.** Mount the Ni-Cd battery pack on the transceiver.
- 2.** Connect AC adapter plug to the external power supply jack on the transceiver
- 3.** Connect to the AC outlet.

- ⚠ Caution:**
- 1** Turn the transceiver power off before recharging the battery pack.
  - 2** Disconnect the EDC-93/94 from the outlet while not using it.
  - 3** Never charge battery packs of other manufacturers with this charger.
  - 4** The required recharging time depends on the condition and model of battery pack. Refer to the instruction manual of the battery pack.
  - 5** Never short-circuit the recharging terminals of this recharger with metal objects, etc. The charger can be damaged.
  - 6** The EDC-93/94 does not work when the voltage from the wall outlet is extremely low.

● **6.0V-700mAh Ni-Cd Battery Pack (EBP-45N)**

The following Battery packs can be used for the DJ-V5 Battery Pack	Charging Time
EBP-45N (6.0V-700mAh)	About 12 hours
EBP-46N (9.6V-600mAh)	About 11 hours

- ⚠ Caution:**
- 1** The battery pack is not charged when shipped. It must be charged before use.
  - 2** It takes 12 hours maximum to fully charge the battery pack with the EDC-93/94.
  - 3** Charging should be conducted in a temperature range of 0 to 40°C.(32°F-104°F)
  - 4** Do not modify, dismantle, incinerate or immerse the battery pack in the water as this can be dangerous.
  - 5** Never short-circuit the battery pack terminals, as this can cause damage to the equipment or lead to heating of the battery which may cause burns.
  - 6** Unnecessary prolonged charging (overcharging) can deteriorate battery performance.
  - 7** The battery pack should be stored in a dry place where temperature is from -20°C to +45°C. (-4°F-+113°F)  
Temperatures outside this range can cause the battery liquid to leak. Exposure to prolonged high humidity can cause corrosion of metal components.
  - 8** Normally, the battery pack can be charged up to 500 times. However, the battery pack can be considered dead if the period of use drops off markedly despite the pack being charged for the aforementioned charging time. When this happens, a new pack should be used.
  - 9** The battery is recycable. At the end of its useful life, under various national and local laws, it may be illegal to dispose of this battery improperly. Check with your local solid waste officials for details on recycling options or proper disposal in your area.
  - 10** When this battery is mounted on the DJ-V5, it can be charged by connecting 13.8V DC-IN.

● **Prevent Short Circuiting the Ni-Cd Battery Pack**

Be extra cautious when carrying the Ni-Cd battery pack; short-circuiting will produce surge current possibly resulting in fire.

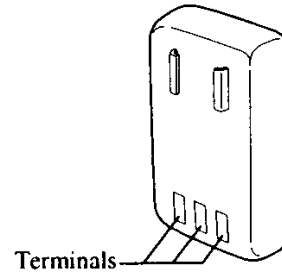

<p><b>DON'T</b> carry with metals of any type, e.g. chains.</p>	<p><b>DON'T</b> carry the Ni-Cd battery pack inside bags of metal plated interior.</p>	<p><b>DON'T</b> place in the proximity of metals or conductives, e.g. nails, chains.</p>
<p>Do enclose inside a non-conductive enclosure (bags or handkerchief made only of non-conductive material).</p>	<p>Do protect by spreading a non-conductive sheet to place on a flat surface.</p>	

**⚠ Caution:** Keep the battery pack inside the included pouch when carrying.



# 1 Names and Functions of Parts

## 1-1 External View

### ■ Front

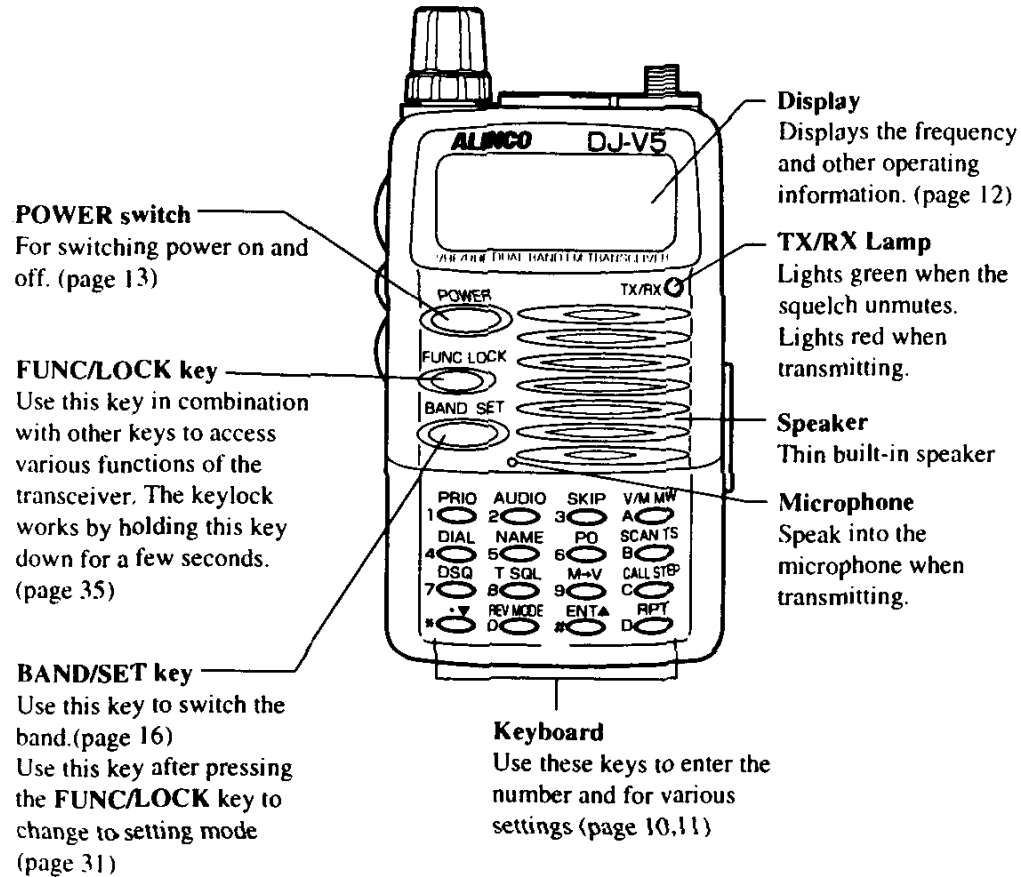

### ■ Top

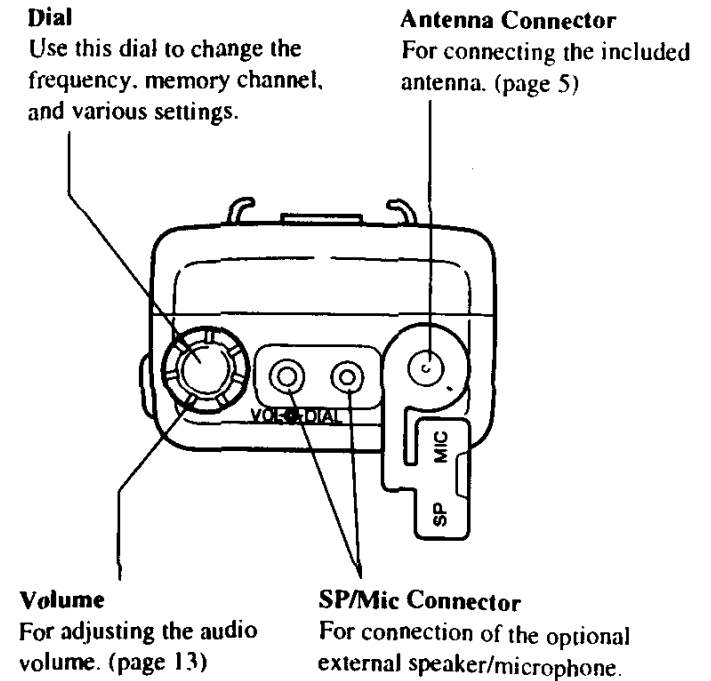

## ■ Side

## ■ Rear

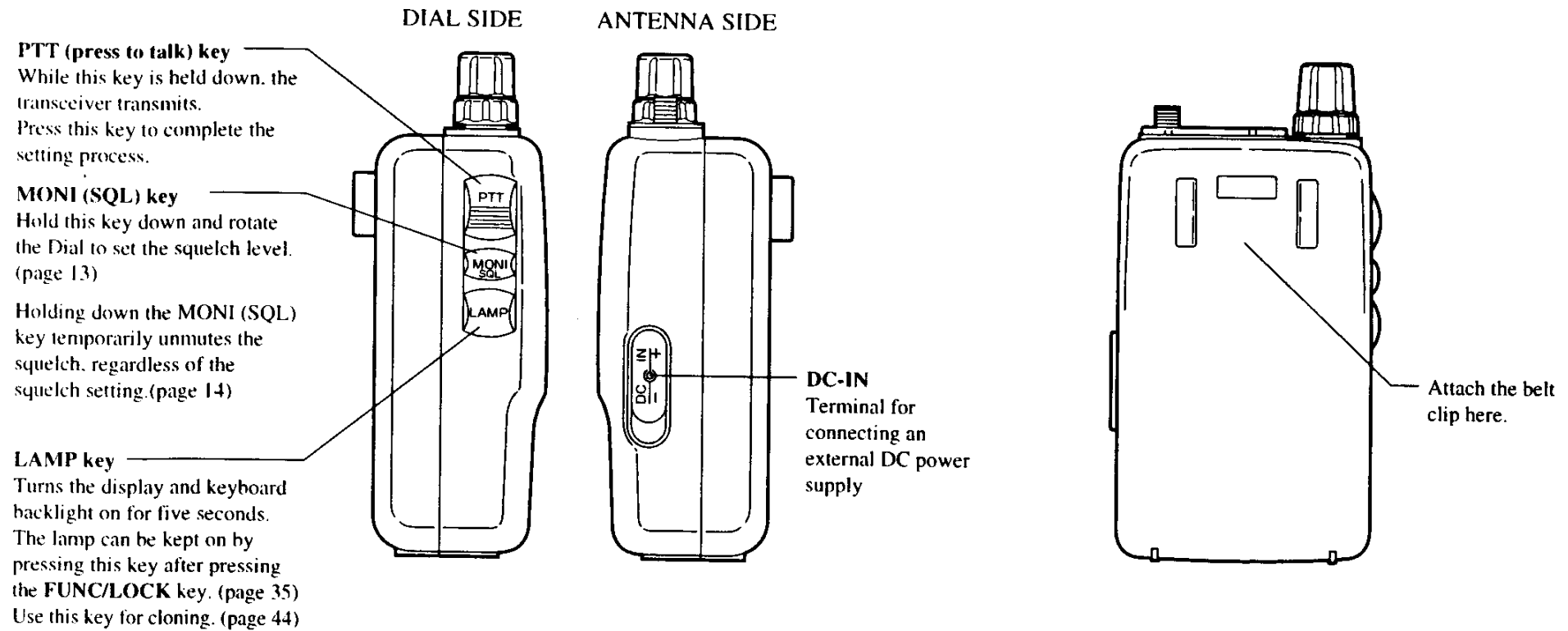

# 1-2 Keyboard

## ■ Upper Part

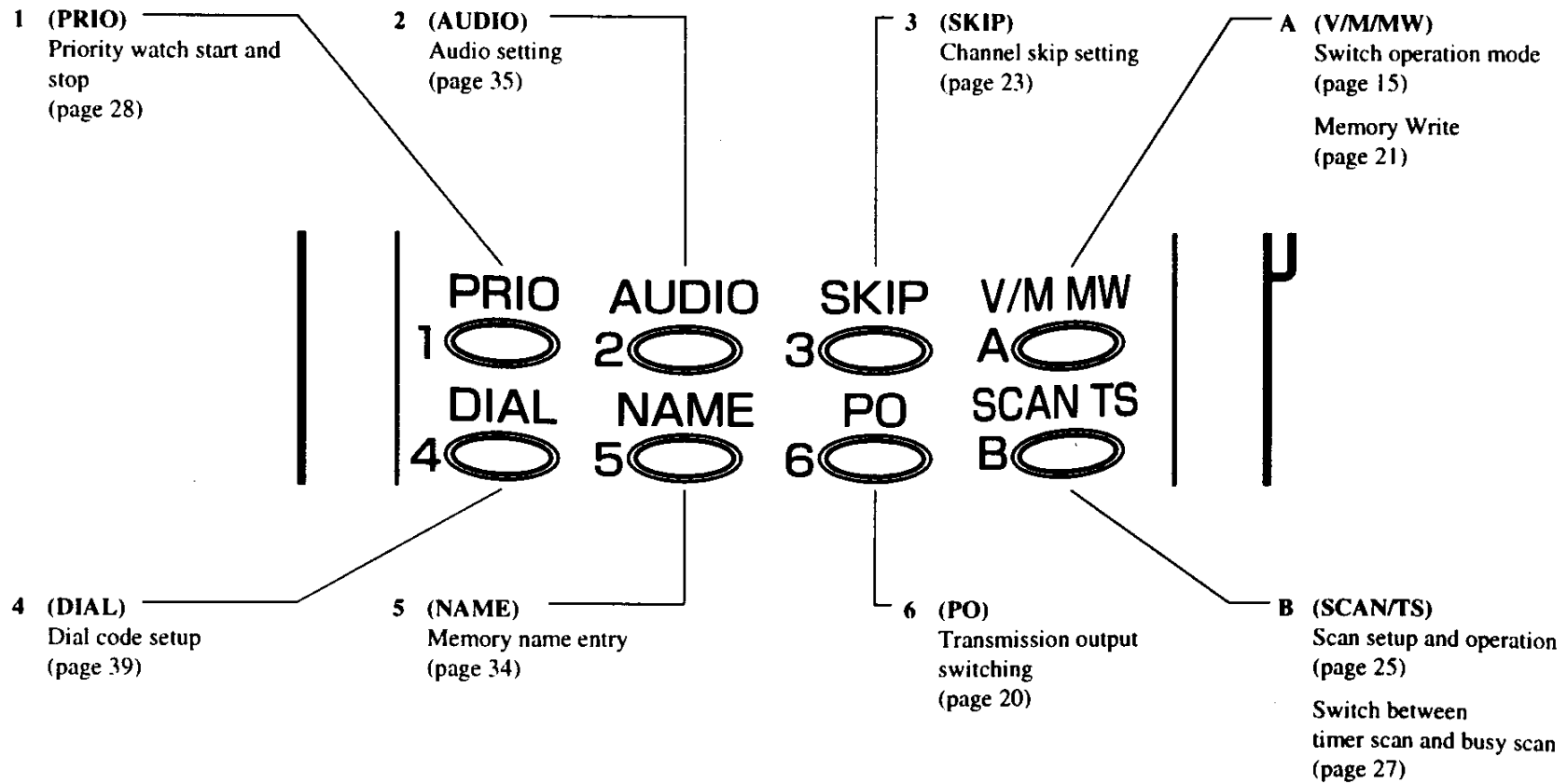
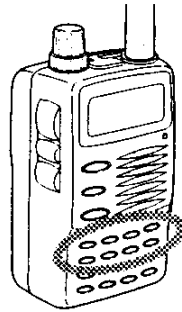

■ Lower Part

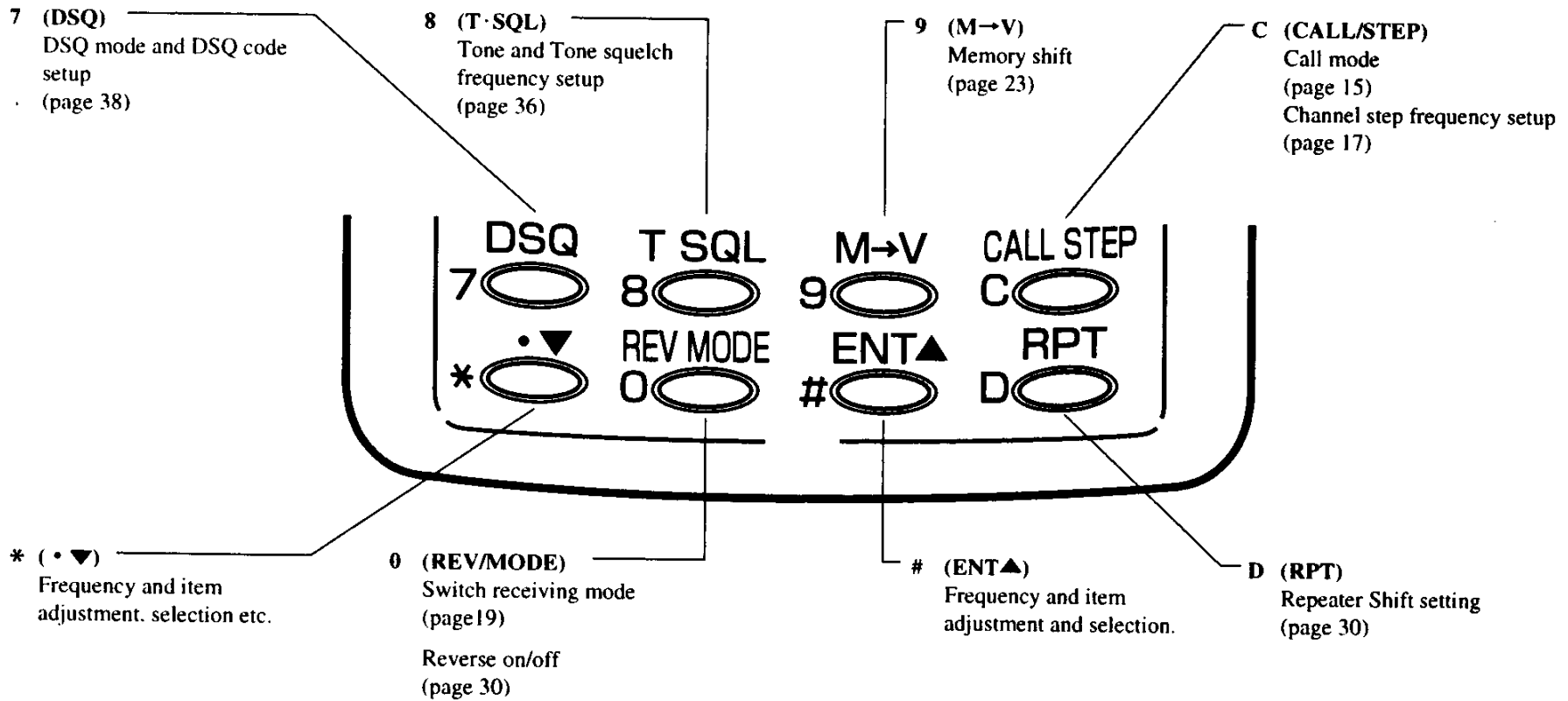
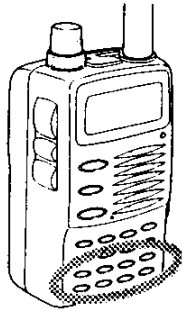

## 1-3 Display

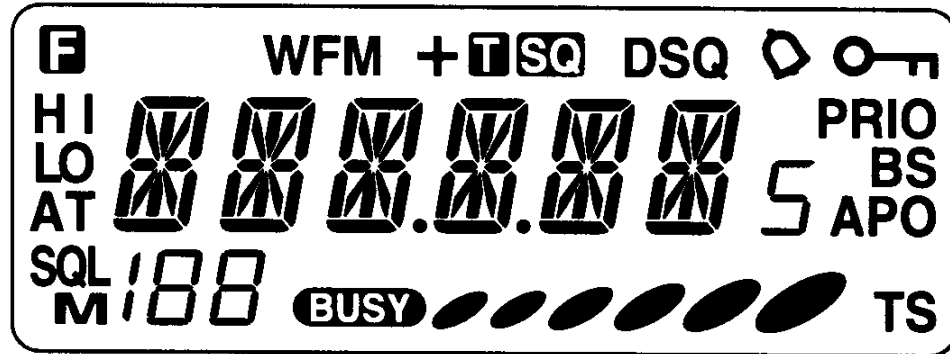

**F**

Appears when the FUNC/LOCK key is pressed.

**HI  
LO**

Indicates transmission output status.

**AT**

Appears when Temperature Protection is on.

**SQL**

Flashes while squelch is being set.  
Appears while monitor function is on.

**M**

Appears when a memory channel is selected.

**188**

Indicates memory channel number.

**||||| 5**

Indicates the frequency and various setting status.

**BUSY**

Appears when the squelch is unmuted.



Indicates the receiving level and transmission output.

**TS**

Appears during Timer Scan setting.

**APO**

Appears when Auto Power Off function is activated.

**BS**

Appears when Battery Save is on.

**PRIO**

Appears when Priority Watch is on.



Appears when keys are locked.



Appears when the Bell Function is on.  
Flashes when a signal is received.

**DSQ**

Appears when the DSQ is on.  
Flashes when the DSQ code matches.

**TSQ**

Appears when setting the tone and the tone squelch.

**+ (-)**

Indicates the shift (+/-) direction.

**WFM**

Indicates the wide FM mode is active.

# 2 Basic Operation

## 2-1 Basic Operation

### ■ Turning the Power On

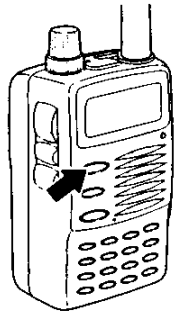

Hold the **POWER** switch down for a second. The power will come on and the power supply voltage will appear on the display. The frequency will be indicated on the display.

To turn the power off, hold the **POWER** switch down until the indication disappears.

### ● Voltage Indication

The power supply voltage is indicated on the display.

**⚠ Caution:** "OVER-V" flashes on the display, and the transceiver makes a beep when the power supply voltage is over 16.0V. None of the functions work in this state because of the overvoltage.

### ■ Adjusting the Audio Volume

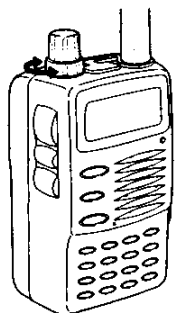

Rotate the Volume dial clockwise to increase the audio volume, and counter-clockwise to decrease it.

### ■ Squelch

The squelch silences the transceiver except for signals above a certain level. Squelch eliminates the noise when the transceiver receives less than a certain level.

"To unmute the squelch" means that the transceiver receives the signal and reproduces the sound.

### ● Adjusting the Squelch

Use the **MONI (SQL)** key to unmute the squelch according to the frequency.

- There are 6 squelch levels (00-05).
- A higher squelch level requires a stronger signal to unmute the receiver.

The default setting is Level 1.

1. Press the **MONI (SQL)** key. "SQL" will appear on the display. It is possible to adjust the squelch level when SQL is indicated on the display.

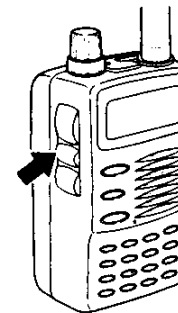

"SQL" appears

2. Rotate the Dial while **MONI (SQL)** key is pressed down to set the squelch level.

2

- 3. Select the squelch level from 00-05 while **MONI (SQL)** key is being pressed.  
Release the **MONI (SQL)** key to complete the setting and return to the previous status.

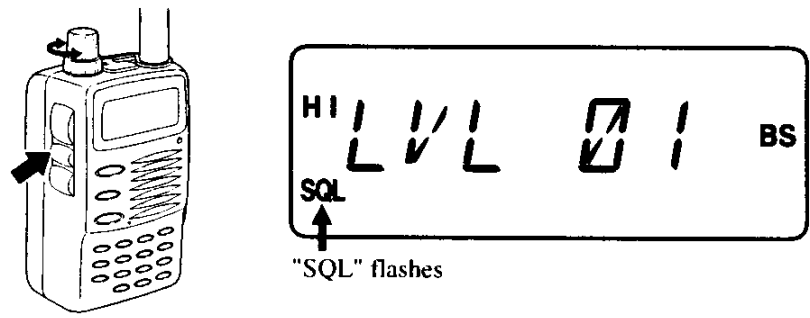

**Monitor Function and Squelch Level**

- The monitor function unmutes the squelch. This is useful when the signal is weak or intermittent.
- Pressing the **MONI (SQL)** key will unmute the squelch. SQL and BUSY will appear on the display.
- There are two Monitor functions : MONI-1 and MONI-2

When MONI-1 is selected, squelch unmutes while **MONI (SQL)** key is being pressed.  
When MONI-2 is selected, squelch unmutes until **MONI (SQL)** key is pressed again.

The default setting is MONI-1.

**Switching MONI-1 and MONI-2**

- 1. Press the **FUNC/LOCK** key. "F" appears on the display.

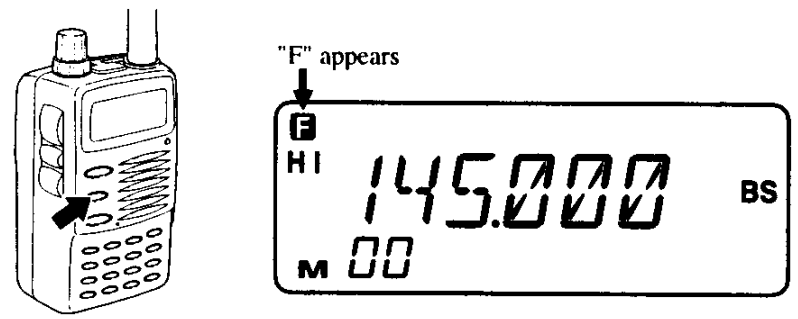

- 2. Press the **MONI (SQL)** key  
Monitor type switches between MONI-1 and MONI-2 every time the **MONI (SQL)** key is pressed.  
Alternatively, you can switch the Monitor function by rotating the Dial while the **MONI (SQL)** key is being pressed.
- 3. Release the **MONI (SQL)** key to complete the setting and return to the previous state.

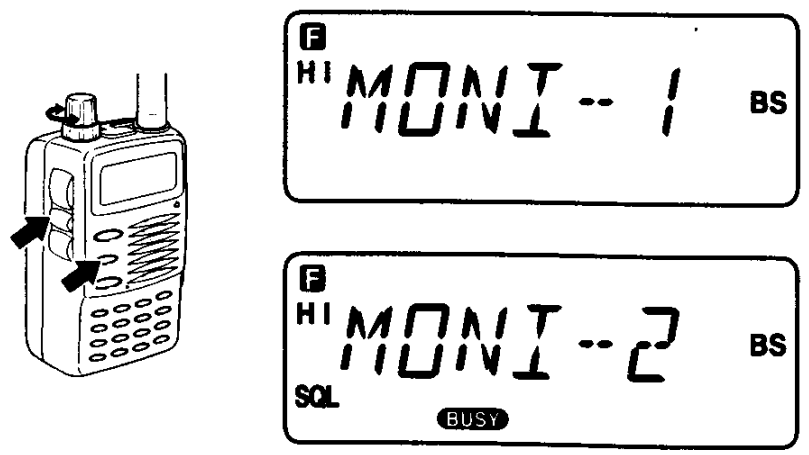

## 2-2 Operating Modes

The DJ-V5 has three operating modes : VFO mode, Memory mode, and Call mode.

### ■ VFO Mode

The factory setting for the DJ-V5 is the VFO mode. The VFO mode allows you to change the frequency, audio, and other settings. There is no specific indication on the display during the VFO mode.

### ■ Memory Mode

In memory mode, you call up and operate on a previously programmed frequency.

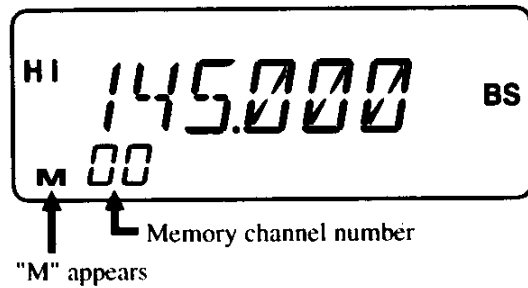

"M" and the memory channel number appear at lower left on the display.

### ■ Call Mode

The Call mode is used when you are waiting to receive or transmit on the Call channel.

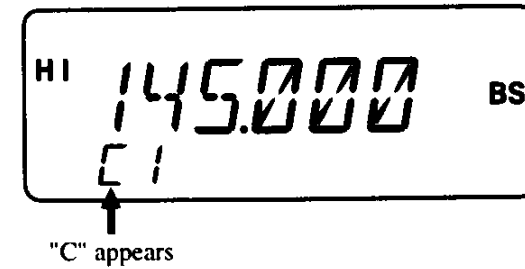

"C" appears on the display instead of the memory channel number.

### ■ Switching Between Modes

The three operating modes rotate as shown in the diagram below.

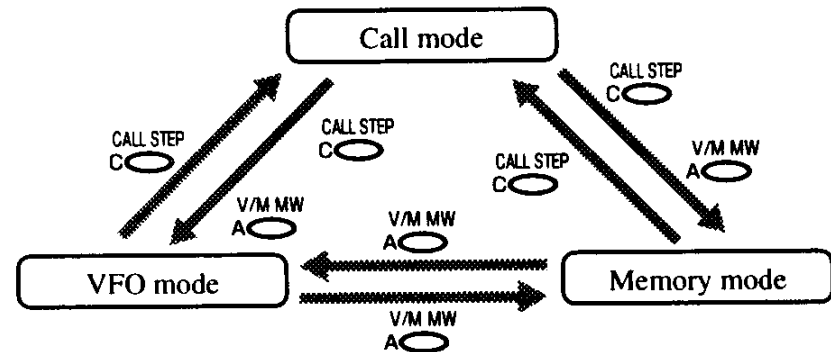



## 2-3 Setting the Frequency in the VFO Mode

The VFO mode has one channel each for FM radio, VHF, and UHF. The VFO mode allows the frequency to be set easily by using the Dial or the ▲/▼ keys. Allowed frequency ranges:

FM radio	DJ-V5T:76.000-107.995 MHz DJ-V5E:87.500-107.995 MHz
VHF band	DJ-V5T:144.000-147.995 MHz DJ-V5E:144.000-145.995 MHz
UHF band	DJ-V5T:420.000-449.995 MHz DJ-V5E:430.000-439.995 MHz

### ■ Switching the Band

Press the **BAND/SET** key to switch the band. Each press of the key changes the band as shown below.

VHF band → UHF band → FM radio → VHF band → ...

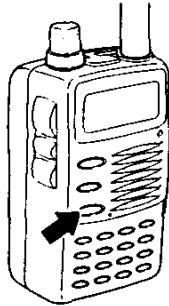

### ■ Adjusting the Frequency in Tuning Steps

- Rotate the Dial clockwise one click to increase the frequency by one tuning step. Rotate the Dial counter-clockwise for one click to decrease it by one tuning step.

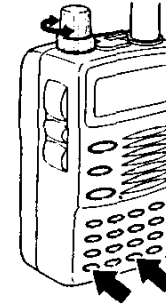

- When using the keyboard, press the **#(ENT/▲)** key to increase the frequency one tuning step. Press **\* (· /▼)** to decrease it one tuning step.

**Note:** *When the frequency exceeds the upper (or lower) limit of the currently selected band, the frequency jumps to the lower (or upper) limit.*

**References:** *Holding the ▲/▼ keys down for 0.8 seconds scrolls through the frequency band.*

### ● Setting the Tuning Step

The tuning step default setting is 5kHz (DJ-V5T), 12.5kHz (DJ-V5E).  
It can be selected from the following :  
5,10,12.5,15,20,25,50,100 kHz.  
The default setting is 100kHz(FM).

1. Press the **BAND/SET** key to select the band on which you wish to change the tuning step.
2. Press the **FUNC/LOCK** key, then the **C(CALL/STEP)** key to change the tuning step setting.

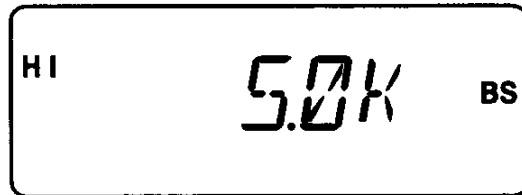
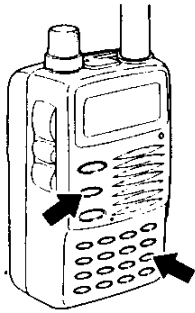

3. Rotate the Dial or press the **▲/▼** keys to select the tuning step.
4. Press the **PTT** key to complete the setting.  
The display returns to the frequency display.

### ■ Adjusting in 1 MHz Steps

Press the **FUNC/LOCK** key, then the **▲/▼** keys to adjust the frequency in 1 MHz increments.

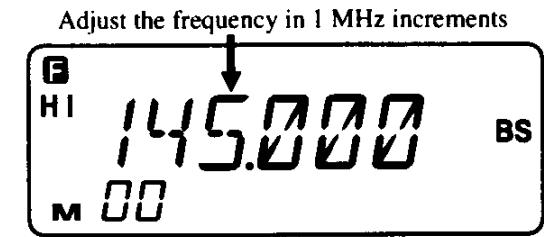
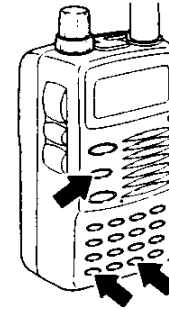

*Note: When the frequency exceeds the upper (or lower) limit for the frequency range of the currently selected band, the frequency jumps to the lower (or upper) limit.*

## ■ Entry From the Keyboard

Enter the frequency from the 100 MHz digit when VHF/UHF is selected. Enter the frequency from the 10 MHz digit when FM is selected.

How the final digit is entered depends on the set tuning step.

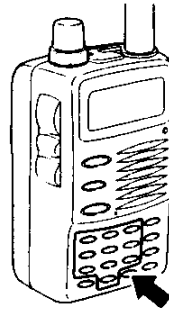

Example :

When entering 88.10MHz on the FM band..

8 → 8 → . → 1 (Tuning step: 10kHz)

When entering 145.00MHz on the VHF/UHF band.

1 → 4 → 5 → 0 → 0 → 0 or 1 → 4 → 5 → # (ENT/▲)

(Tuning step: 5kHz)

**Note:** # (ENT/▲) key changes all numbers after the decimal to 0.

**Reference:** If you want to cancel the setting, press the **PTT** key or **BAND/SET** key at any time while entering the number. The previous frequency will appear on the display again.

## ■ First Entry Digit for Different Tuning Steps

Depending on the tuning step, entry may be required to the 1 kHz digit or the 10 kHz digit.

Tuning step	Entry completion digit	Final digit selection
12.5kHz	10kHz	When you input the 10 kHz digit, the 1 kHz digit set as follows: {0} : 00.0    {1} : 12.5 {2} : 25.0    {3} : 37.5 {4} : invalid    {5} : 50.0 {6} : 62.5    {7} : 75.0 {8} : 87.5    {9} : invalid
25.0kHz	10kHz	When you input the 10 kHz digit, the 1 kHz digit set as follows: (other entries are invalid) {0} : 00.0    {2} : 25.0 {5} : 50.0    {7} : 75.0
50.0kHz	10kHz	When you input the 10 kHz digit, the 1 kHz digit set as follows: (other entries are invalid) {0} : 00.0    {5} : 50.0
100.0kHz	100kHz	When you input the 100 kHz digit, the 10 kHz digit set as follows: {0} : 000.0    {1} : 100.0 {2} : 200.0    {3} : 300.0 {4} : 400.0    {5} : 500.0 {6} : 600.0    {7} : 700.0 {8} : 800.0    {9} : 900.0
Other	1kHz	Enter {5} for the 1 kHz digit to enter 5 kHz. Any other entry sets the 1 kHz digit to 0.

## 2-4 Receiving

### Basic Operation

- 1 Adjust the volume. (page 13)
- 2 Adjust the squelch. (page 13)
- 3 Set the frequency. (page 16)
- 4 Receive the signal.
  - When the DJ-V5 receives a signal, "BUSY" appears on the display, and you will hear the sound of the received signal.

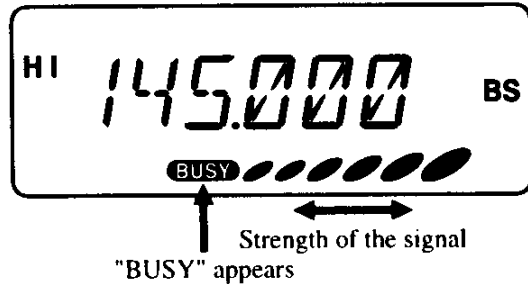

- According to the strength of the received signal, the meter displays up to 6 levels.

### ■ Setting the Receiving Mode

The receiving mode can be switched between FM and WFM (radio broadcasting band).

1. Press the **FUNC/LOCK** key, then the **0(REV/MODE)** key.

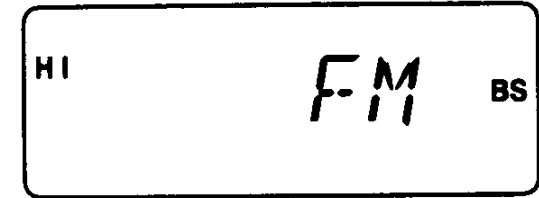
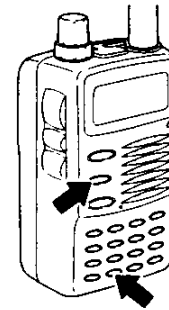

2. Rotate the Dial or press the **▲/▼** keys or the **0(REV/MODE)** keys to select FM or WFM.
3. Press the **PTT** key to complete the setting.

## 2-5 Transmitting

### Basic Operation

- 1 Set the transmission frequency. (page 16)
  - 2 Set the transmission output level.
  - 3 Transmit the signal.
1. Check the transmission frequency and output level, and hold the PTT key down.
  2. Speak into the microphone when TX/RX lamp lights red.
  3. When you release the PTT key, the transceiver will revert to reception.

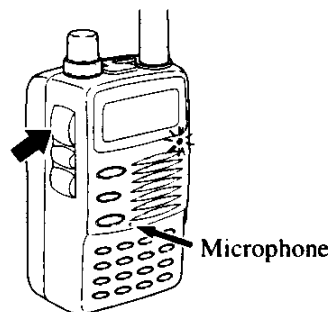

**Note:** While transmitting, the receiver does not operate.

**⚠ Caution:** Before transmitting, confirm other stations are not using the same frequency as yours.

### ■ Setting Transmission Output Level

1. Press the FUNC/LOCK key, then the 6(PO) key. The transmission output level will be shown.

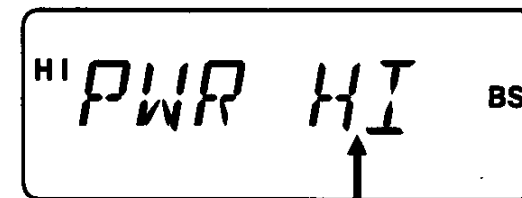
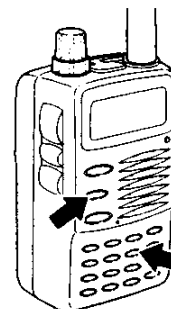

"HI" flashes

The default setting is HI.

2. Use the 6(PO) key and the Dial, or ▲/▼ keys to select the transmission output level from HI, L1, and L2. HI is the strongest, and L2 is the weakest. Depending on the transmission output level, power consumption varies.
3. Press the PTT key to complete the setting. The display returns to the frequency display.

The quantity of the ovals in the S Meter shows the transmission output. When 6 ovals are indicated, the output is HI. When 3 ovals are indicated, the output is L1. When 2 ovals are indicated, the output is L2.

**Reference:** Auto Temp (AT) Function

*If the transceiver gets overheated, the output level automatically switches to L2.*

*"AT" appears on the display. When the transceiver cools down, "AT" disappears and the transceiver returns to the previous setting.*

# 3 Memory Channel and Call Channel

## 3-1 Memory (MR) Channel

The Memory channel is the frequency called up and operated in the Memory mode. The DJ-V5 has 200 memory channels, and each channel has a memory channel number. You can program these channels to enable quick and easy recall of frequencies and memory settings.

**Note:** *It is not possible to increase the number of memory channels.*

### ■ Selecting a Memory Channel Number

In VFO mode, press the **FUNC/LOCK** key. An "M00" icon appears as shown below.

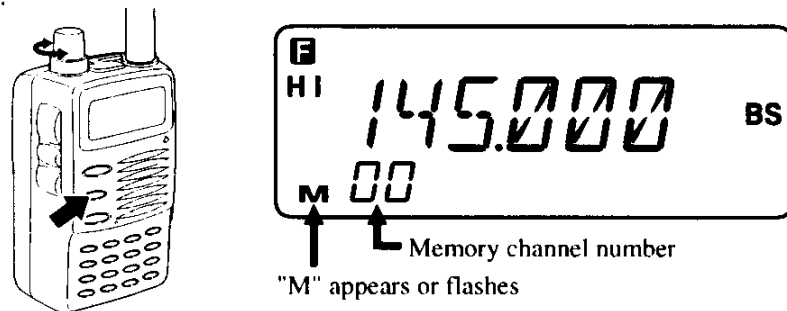

A flashing "M" indicates that the channel is not programmed yet. Once the channel is programmed, "M" stays firm. Rotate the Dial ; M00, M001, M002...appear as the dial is turned clockwise and MC2, MC1, M5b, M5A...appear as it is turned counter-clockwise.

**Note:** *At default status, no memory channels except CALL channels (MC1, MC2) are programmed.*

### ■ Programming a Memory Channel

All memory channels can be programmed with the following information:

- TX/RX frequency · Shift frequency and direction · CTCSS tone
- Tuning step · TSQ setting · DSQ setting
- Output power level · Alphanumeric/CH tag

### ● Memory Channel Programming

1. Return to VFO mode by pressing the **FUNC/LOCK** key to program the information mentioned above. Refer to the following sections. (i.e. Section 4 Functions and Section 5 Communicating) for instructions on how to program each function, with the exception of the Alphanumeric tag (refer page 33).
2. Press the **FUNC/LOCK** key to return to the memory mode, and then select one of the channels indicated with M00 to M199 by rotating the Dial. Press the **A (V/M MW)** key to complete the programming, a beep is heard and "M" icon disappears.

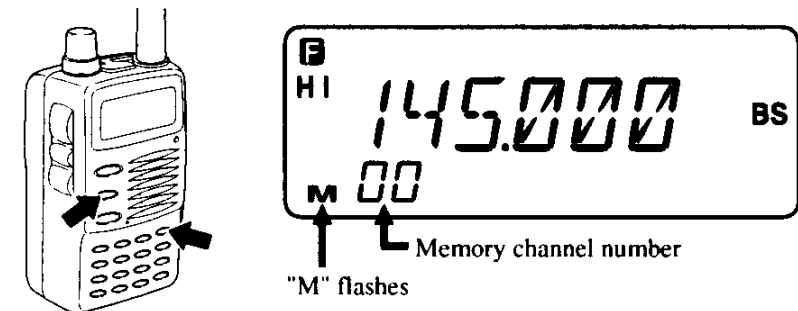

3. Repeat the sequence to store more memories. To replace the new information on a pre-stored channel, program new information in VFO mode, return to Memory mode and press the **A (V/M MW)** key.

**Note:** *Alphanumeric tag will not be automatically cancelled.*

### ● Programmed-Scan Channel Programming

There are 5 program scan banks with 10 pairing memory channels available. Each of the banks has an A and B channel to store the edge-frequencies of the program scan.

To program the pairing channels (i.e. 1a and 1b), use the same sequence that was used to store memory channels. In this feature Cross-Band scan is possible too. Section 4-1 on page 25 explains the scan mode and its operation.

### ● Call-Channel Programming

Refer page 24 for details.

### ■ Calling up a Programmed Memory Channel Number

Press the A(V/M/MW) key to select the Memory mode.

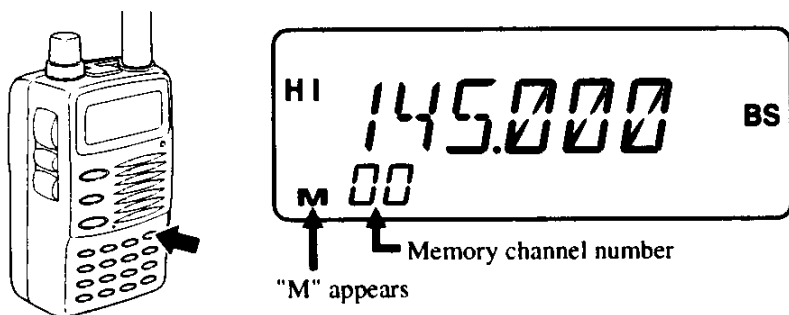

Rotate the Dial or press the ▲/▼ keys to call up a programmed memory channel number.

### ■ Clearing a Memory Channel

1. Press the A(V/M/MW) key to select the Memory mode.
2. Rotate the Dial or press the ▲/▼ keys to select the memory channel number that you wish to clear.

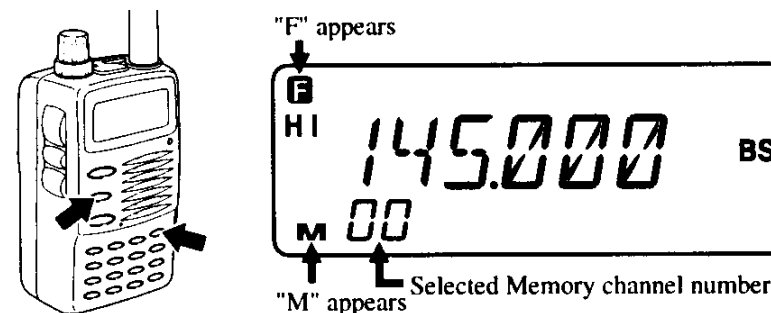

Clear a program channel in the same way.

3. Press FUNC/LOCK key, then the A(V/M/MW) key to clear the memory data. "M" appears on the display, then flashes.

**Note:** *It is not possible to set the memory channel skip while scanning.*

**Reference:** *If you clear the memory data by mistake, press FUNC/LOCK key while "M" is flashing, then press the A(V/M/MW) key. The clearing operation will be canceled and the memory data will be displayed again.*

**Note:** *It is not possible to clear the memory channels C1 or C2. To clear these channels, overwrite the data.*

## ■ Setting the Memory Channel Skip

1. Press the **A(V/M/MW)** key to select the Memory mode.
2. Press the **FUNC/LOCK** key, then the **3(SKIP)** key. Decimal point "." will disappear, and this memory channel will be skipped during memory scanning.

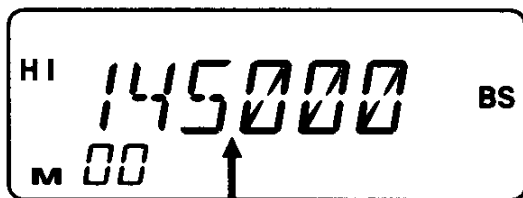
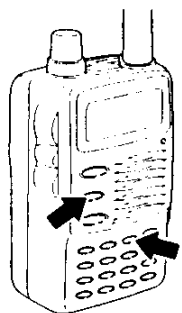

Decimal point disappears

3. To release the memory channel skip, press the **FUNC/LOCK** key, then the **3(SKIP)** key again. The decimal point "." will appear.

## ■ Memory Shift

When using the memory shift, the data of a specific memory channel can be transferred to the VFO mode.

1. In the memory mode, select the memory channel number that you wish to transfer to VFO mode.
2. Press the **FUNC/LOCK** key, then the **9(M → V)** key. The data of memory channel will be copied into the VFO channel, and the transceiver will switch to the VFO mode.

The various settings which are transferred follow the data of the memory channel.

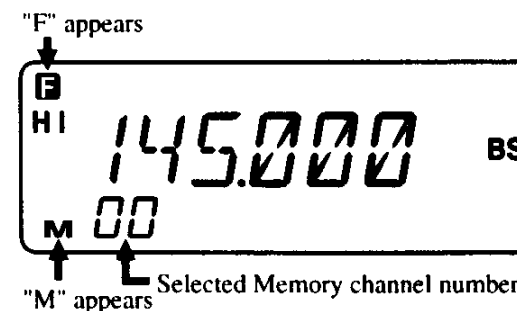
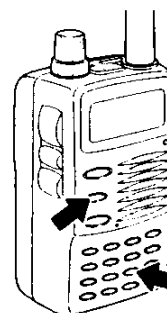



## 3-2 Call Channel

The call channel is the channel which is called up and operated in the call mode. There are two call channels; one for VHF, one for UHF. Call channel can also be used as a regular memory channel. The call channel allows you to easily recall an often-used-frequency.

Factory settings

C1:145.00MHz, C2:445.00MHz (DJ-V5T)

C1:145.00MHz, C2:433.00MHz (DJ-V5E)

### ■ Selecting a Call Channel

1. Press the C(CALL/STEP) key to select the call mode.
2. Press the BAND/SET key to select C1 or C2.

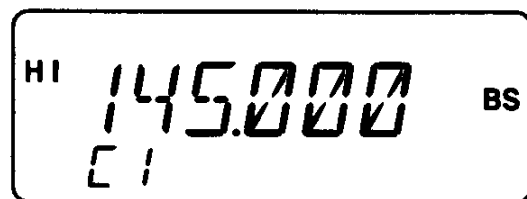
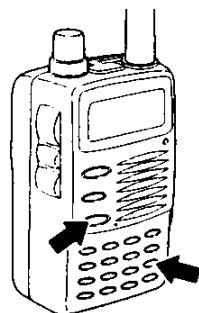

**Note:** *Regardless of the programmed data, the call channel C1 is automatically called up when VHF(DJ-V5T:144.000-147.995MHz, DJ-V5E:144.000-145.995MHz) is on the display, and the call channel C2 is automatically called up when UHF(DJ-V5T:420.000-449.995MHz, DJ-V5E:430.000-439.995MHz) is on the display in the VFO mode.*

### ■ Programming a Call Channel

1. Adjust the frequency that you wish to program in the VFO mode. Then press the FUNC/LOCK key.
2. Select a call channel (C1 or C2), then press the A(V/M) key.
3. The transceiver makes a beep and completes programming.

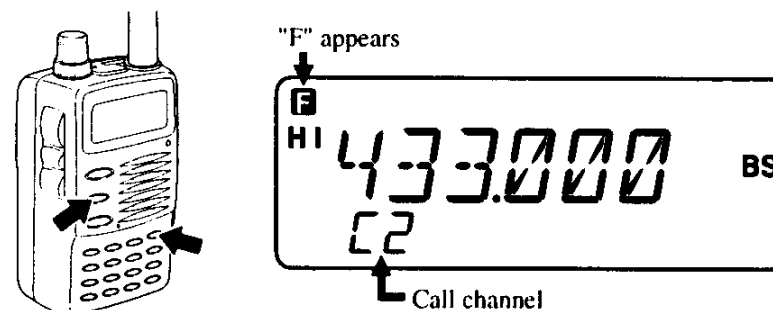

**Note:**

- *In the call mode, it is not possible to call up programmed channels other than C1 and C2.*
- *It is not possible to clear memory channels C1 or C2. If you want to clear these memory channels, overwrite the data.*

# 4 Functions

## 4-1 Scan Modes

The scan functions periodically vary the frequency or change memory channels to search for signals.

The DJ-V5 has three scan modes : Band scan, Programmed scan, and Memory scan modes.

Memory scan also has Skip scan.

### ● Band Scan

Scans the entire band in the VFO mode.

### ● Programmed Scan

Select a frequency range before scanning in the VFO mode.

Scans the channels programmed in the memory channel within a designated frequency range.

### ● Memory Scan

Scans the memory channels.

### ● Skip Scan

Scans the memory channels except those for which memory skip is set.

## ■ Band Scan and Programmed Scan

In order to activate Programmed-scan, the frequencies must be stored in memory channel bank 1A - 5B, as described on page 21.

1. In the VFO mode, press the **B (SCAN/TS)** key and hold. "BAND" or one of the programmed scan bank numbers appears on the display.
2. With the **B (SCAN/TS)** key still pressed, rotate the Dial to select the scan mode. As the Dial is turned, programmed bank numbers such as "BAND", "PRG-1A", PRG-1B"....."PRG-5B" appears on the display (the scan mode used the last time is displayed initially).

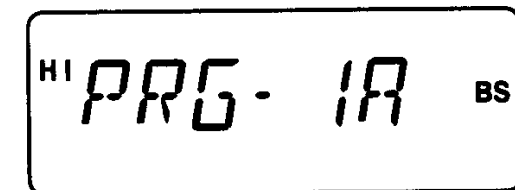
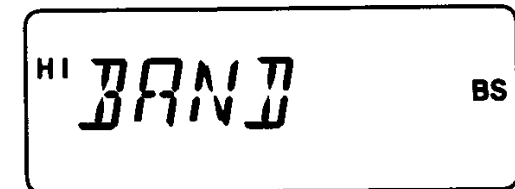

*Note: If the programmed scan banks are not set prior to this operation, PRG-XX" will not appear.*

3. Release the **B (SCAN/TS)** key to start scanning in the selected mode. The Scan direction depends on the direction of the last scan operation, at the designated tuning step. A decimal point will flash during the scan. To stop the scan, press the **PTT** key or the **B (SCAN/TS)** key.

4

**Note:** When nothing is programmed in memory, only "BAND" appears on the display, and it is not possible to select the program channel. When the B(SCAN/TS) key is released, a band scan will start.

**Reference:** Programming a Memory Channel (page 21)

### ■ Memory Scan and Skip Scan

In the memory mode, while the B(SCAN/TS) key is being pressed, "MEMORY" appears on the display.

Rotate the Dial to switch between the memory scan and skip scan. Turning the Dial either clockwise or counter-clockwise displays the following order:

"MEMORY" → "SKIP" → "MEMORY" → "SKIP" → ...

※ At first, the scan used the last time is displayed.

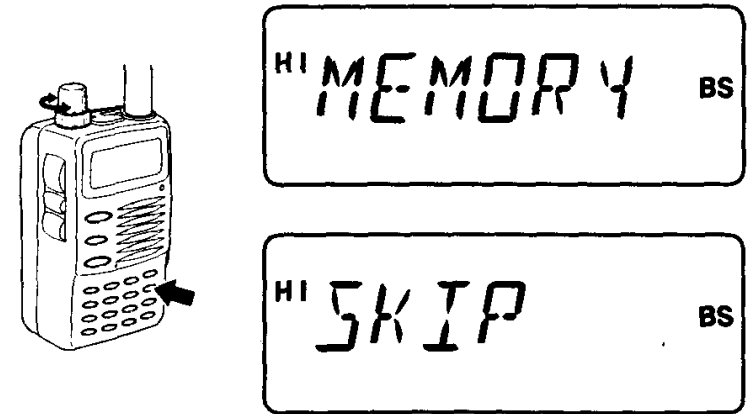

Release the B(SCAN/TS) key to start scanning. When MEMORY is selected, a memory scan starts. When SKIP is selected, skip scan starts.

When nothing is programmed in the memory channel, the unit makes a beep, and it is not possible to do either a memory scan or a skip scan.

The unit scans in order of the memory channel number, and in the direction of the last operation (up or down).

When "SKIP" is selected, release the **B(SCAN/TS)** key to scan the memory channels where a memory skip is not programmed. The unit scans in order of the memory channel number, and in the direction of the last operation (up or down).

*Reference: Setting the Memory Channel Skip (page 23)*

*Note: In the memory scan and skip scan channels, C1, C2, and 1A ~ 5B are not scanned.*

### Common Functions of All Scans

- While scanning, the "." (decimal point) flashes.
- While scanning, the tuning step is that set for each band. When the frequency reaches the upper (or lower) limit of the band range, it jumps to the lower (or upper) limit.
- While scanning, the scanning direction can be switched by rotating the Dial or pressing the ▲/▼ keys.
- While scanning, rotating the Dial or pressing any key except for the **LAMP**, **MONI(SQL)**, and the ▲/▼ keys, stops scanning.
- If scan stops at the middle, the next scan resumes from the frequency where it stopped.

### Setting Scan Resume Conditions

There are two scan resume conditions : Busy scan and Timer scan resume.

If the signal of the indicated frequency is picked up, the unit continues scanning depending on the scan resume condition.

When shipped from the factory or reset, Busy scan is set.

#### ● Busy Scan

Scanning stops while receiving, resumes 2 seconds after reception ends.

#### ● Timer Scan

Even during signal reception, the unit starts scanning 5 seconds after receiving on resumes 2 seconds after completing receiving.

#### ● Switching Busy Scan and Timer Scan

1. Press the **FUNC/LOCK** key, then the **B(SCAN/TS)** key. This switches the resume condition between Busy scan and Timer scan.
2. When Timer scan is selected, "TS" appears on the display.
3. When Busy scan is selected, "TS" disappears.

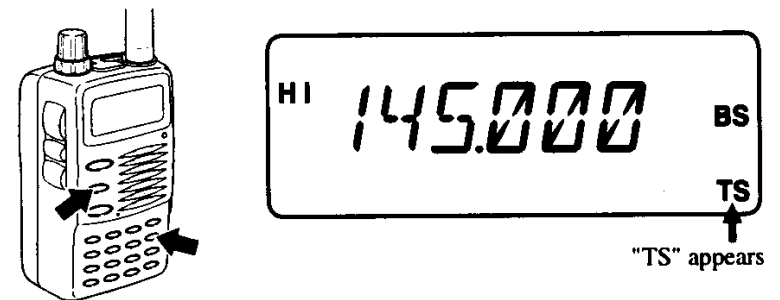

### ■ Scan Operation When Setting Tone Squelch and DTMF Squelch

- While using tone squelch, the transceiver stops scanning when the transceiver receives a signal. When the received tone is not the tone frequency that you have selected, the squelch does not unmute.
- DTMF squelch is nullified, and "DSQ" disappears while scanning. Even if the received DSQ code does not match the code that you have selected, you can hear the received signal.

## 4-2 Priority Watch

Priority Watch monitors a channel different from the indicated frequency.

Every 5 seconds, the transceiver switches from the indicated frequency to the priority channel.

If a signal is received on the priority channel, the transceiver makes a beep, and the reception time is extended to 2 seconds.

Type	Start mode	Priority channel (momentary reception)	Display Frequency (5 sec)
VFO priority watch	VFO	Memory	VFO
Memory priority watch	Memory	VFO	Memory
Call priority watch	Call	VFO, Memory*	Call

\*The frequency before calling the call channel is the priority channel.

*Note:* Priority watch works only with the combinations above.

### ■ Turning Priority Watch On

1. Select the operation mode of the priority channel that you wish to receive.(2 seconds scan)
2. Call up the mode that you wish to receive for 5 seconds (non-priority).
3. Press the **FUNC/LOCK** key, then the **1(PRIO)** key.
4. "PRIO" appears on the display, and Priority watch starts.

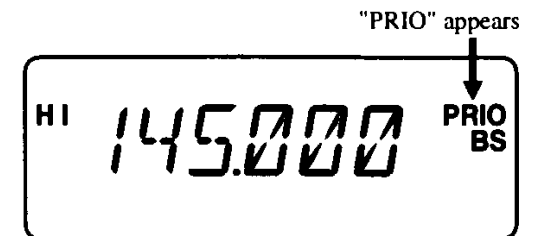
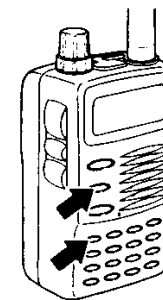

## ■ Simultaneous Operation of Priority Watch and Scans

On the five-second side of the VFO priority, rotate the Dial while the **B(SCAN/TS)** key is being pressed down to select the scan setting.

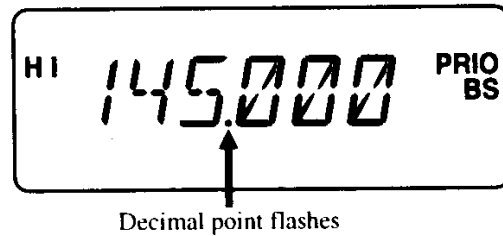
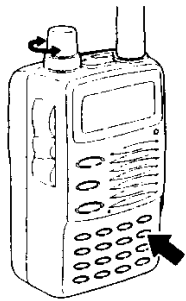

Scanning starts when releasing the **B(SCAN/TS)** key.

## ● Stop Scanning Only

During the operation on the five-second side, rotate the Dial or press any key to stop scanning, except for the **LAMP,MONI(SQL)**, **▲/▼**, and **1(PRIO)** keys.

Scanning stops and only priority watch remains active.

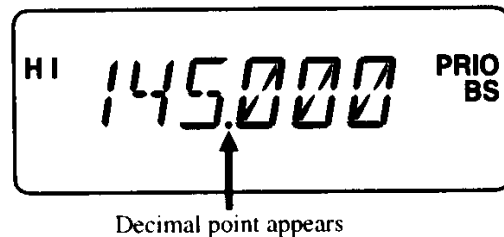
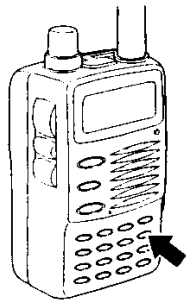

## ● Stopping Priority Watch Only

During the operation on the five-second side, press the **1(PRIO)** key. "PRIO" disappears from the display.

Priority watch stops, and only scan remains active.

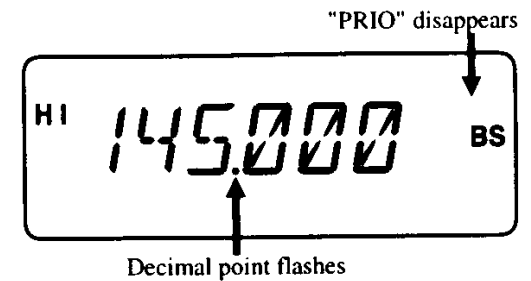
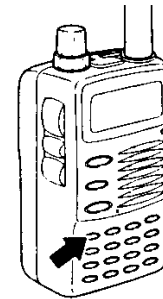

- Reference:*
- In the operating mode set on the five-second side, it is also possible to transmit by pressing **PTT** key. During the transmission, even if the five seconds pass, the transceiver will not switch to the priority channel.
  - On the five-second side of the VFO priority and memory priority, it is possible to change the frequency and memory channel with the Dial and **▲/▼** keys.

- Reference:*
- If you want to stop the scan and priority watch at the same time, press the **PTT** key when the priority channel side is selected.

- Note:*
- When tone squelch (**TSQ**) is selected during priority channel side operation, extension of reception on the operating mode of priority channel side is the same as the scan resume conditions of regular operation. (page 27)
  - While priority watch is operating, "D · SQ" disappears and DTMF squelch (**DSQ**) stops, even if it is on. To resume DTMF squelch (**DSQ**), turn priority watch off.

## 4-3 Repeater Operation

### ■ Repeater Shift

This function changes the transmission frequency in relation to the receiving frequency.

1. Press the **D(RPT)** key to change to the display for setting the Repeater Shift frequency. "00.600" appears on the display when VHF band is selected, while "05.000" appears when UHF band is selected.

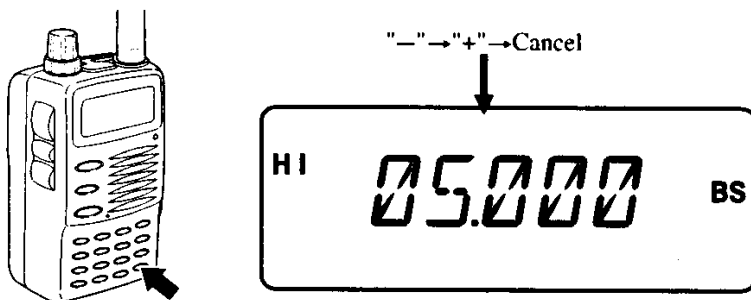

The default settings are: VHF : 0.6MHz, UHF : 5.0MHz

2. Each press of the **D(RPT)** key changes the setting as follows :  
- → + → cancel → - → + . . . . .
3. Adjust the frequency with the Dial or ▲/▼ keys.  
Range : 0 ~ 99.995MHz  
The frequency tuning step is that set for each band.  
When adjusting the frequency in 1 MHz steps, press the **FUNC/LOCK** keys, then rotate the Dial or press the ▲/▼ keys. If the frequency exceeds the upper (or lower) limit of the frequency range of the currently selected band, the frequency jumps to the lower (or upper) limit.
4. Press the **PTT** key to complete the setting of shift direction and shift frequency, and display the frequency.  
While the shift is working, transmitting is possible by pressing the **PTT** key. The transmission frequency will appear on the display.

**Note:** *If the transmission frequency is beyond the amateur band, it is not possible to transmit, and "OFF" appears on the display.*

### ■ Reverse

This function is for checking if it is possible to communicate without using a repeater.

1. Adjust the frequency for communication by using the shift.
2. While pressing the **0(REV/MODE)** key down, the frequency on the display changes to the programmed transmission frequency, and keeps receiving. "-" or "+" flashes on the display while receiving.
3. When releasing the **0(REV/MODE)** key, the frequency on the display returns to the receiving frequency, and the regular reception starts.

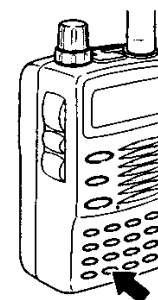

**Note:** *When the repeater shift is not programmed or the result of reverse is outside of the amateur band, the 0(REV/MODE) key is not responsive.*

## ■ Tone Burst

This function generates a tone burst at user-set frequency.

1. Press the **FUNC/LOCK** key, then the **D(RPT)** key to move to the tone burst frequency setting mode. The tone burst frequency appears on the display.
2. Set the tone burst frequency with the Dial or the **▲/▼** keys. The following tone burst frequencies are available.  
1750, 2100, 1000, 1450 (Hz)

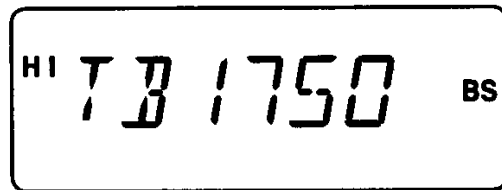
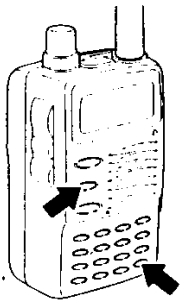

3. Press the **PTT** key to complete the setting.  
During tone burst transmission, MIC is muted. In this state, only the tone burst frequency is transmitted even if other tones are set.  
To transmit the tone burst frequency, press the **BAND/SET** key while the **PTT** key is being pressed.

## 4-4 Mode Settings

In setting mode, you can set six different functions of the DJ-V5. Every function is operated in the same way.

1. Press the **FUNC/LOCK** key, then the **BAND/SET** key to move to the setting mode.

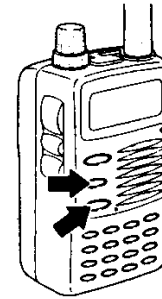

2. Select the function that you wish to set by using the **▲/▼** keys.
3. Change the function with the Dial.
4. Press the **PTT** key to complete the setting and return to the frequency display.

### ■ Beep Function

The beep that sounds when operating the transceiver can be turned off.  
Beep On : "BP-ON"  
Beep Off : "BP-OFF"

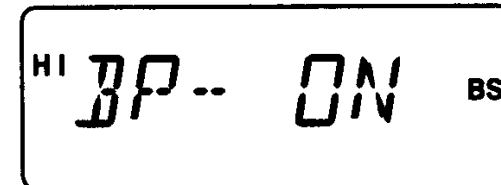

The default setting is BP-ON.



■ **Bell**

The bell informs you that you are being called by sounding a bell, and flashing the bell icon on the display.

- When the bell function is on, bell icon appears on the display. The bell icon flashes, and a bell sound rings when a signal is received.
- When using the bell at the same time as the tone squelch or DTMF squelch, a different bell rings.

Bell on : BELON

Bell off : BELOFF



The default setting is BELOFF.

*Note: When beep function is off, a bell sound does not ring even if the transceiver receives a signal. Instead, the bell icon flashes.  
Bell function automatically turns off by transmitting.*

■ **Auto Power Off (APO)**

This function automatically turns off the power if there is no operation for a specified period of time.

- An alarm goes off one minute before the transceiver turns off. The alarm also goes off just before turning off.
- Rotate the Dial to change the setting. The setting varies as follows:  
APO30(30 min) → APO60(60 min) → APO90(90 min)  
→ APOOFF → APO30(30 min) →...



The default setting is APOOFF.

■ **Battery Save (BS)**

The battery save function extends battery life. If there is no key operation for five seconds, the internal power of the transceiver rapidly cycles between on and off.

Internal power ON : OFF = 200ms : 400ms BS-0.4

Internal power ON : OFF = 200ms : 800ms BS-0.8

Internal power ON : OFF = 200ms : 1600ms BS-1.6

BS-0.4 → BS-0.8 → BS-1.6 → BS-OFF → BS-0.4 →...

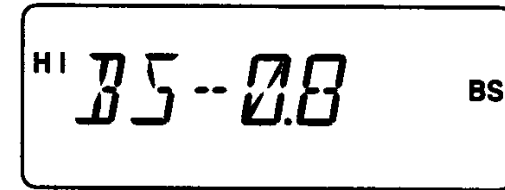

The default setting is BS-0.8.

■ **Setting the DTMF Transmission Delay Time**

Normally, DSQ codes are sent 850 ms after the PTT key has been pressed. This can be changed to 450 ms.

DT-850 → DT-450 → DT-850 →...

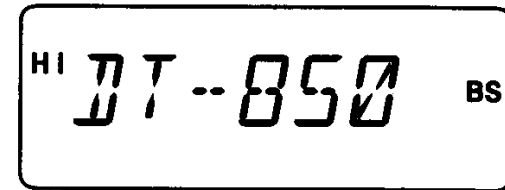

The default setting is DT-850.

## ■ Split

This function changes the transmission frequency in relation to the receiving frequency. The transceiver receives the currently displayed VFO frequency, and transmits the frequency selected from a memory channel.

When receiving in the memory mode, the transceiver receives and transmits the frequency selected from the memory channels.

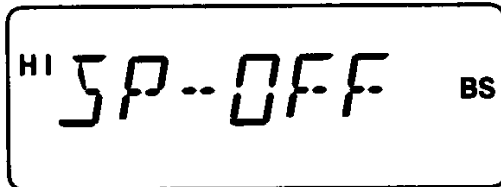

The default setting is SP-OFF

When split function is ON, decimal point "." flashes. Decimal point flashes while receiving, and it is displayed solidly while transmitting.

Use this function for Cross-band operation, too.

## 4-5 Other Functions

The DJ-V5 has the following supplementary functions.

### ■ Display Choices

There are two types of displays : Frequency display and Channel display.

#### ● Frequency Display

Displays the operating frequency. When the transceiver is shipped or reset , frequency display is selected.



#### ● Channel Display

Displays the memory channel number or the call channel number which is programmed.

If nothing is programmed in the memory channel, "CH 00" appears on the display.

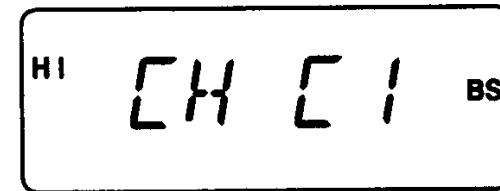

#### ● Switching Between the Frequency Display and Channel Display

Turn the power on while A(V/M/MW) key is being pressed.

The frequency display and channel display alternate every time this operation is performed.



## ■ Naming Memory Channels

The memory channel can be named, and these names are shown on the display. Each memory channel name can have 6 characters maximum. 48 different of alphanumeric characters are available : 0~9, A-Z, Space, (, ), +, -, =, \*, /, Δ, μ, Σ, and ∴.

1. Select the memory mode, and call up the memory channel that you wish to name.
2. Press the **FUNC/LOCK** key, then the **5 (NAME)** key to change the display to the memory channel naming mode.

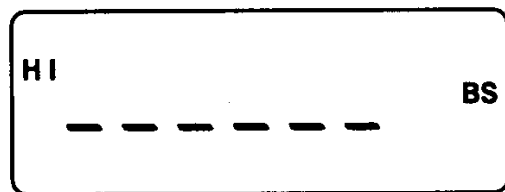
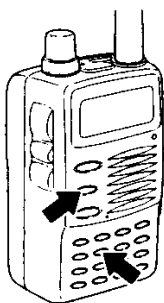

3. Select the characters with the Dial, and select the column with the ▲/▼ keys.

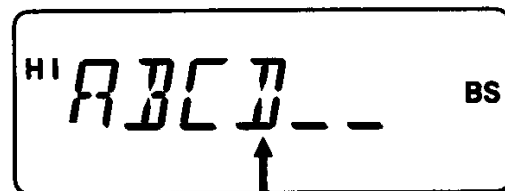
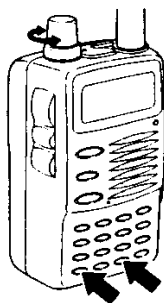

Selected column flashes

4. Press the **PTT** key to complete the setting and return to the memory name display.

To clear a memory name, press the **FUNC/LOCK** key, then the **C(CALL/STEP)** key.

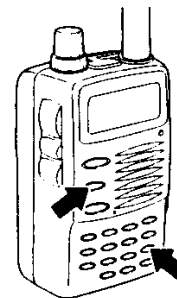

*Reference:* Even when the memory name display is selected, it is possible to indicate the currently operating frequency. Press the **8(T SQL)** key to indicate the frequency temporarily. When the shift direction is set, press the **0(REV/MODE)** key to turn the reverse function on and indicate the transmission frequency.

*Note:* When the channel display is selected, the memory channel number is indicated instead of the name.

## ■ Setting the Audio Modulation

1. Press the **FUNC/LOCK** key, then the **2(AUDIO)** key to move to the Audio adjusting mode.

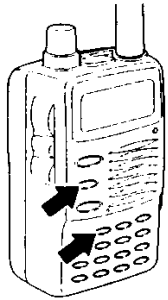

"HI" flashes  
The default setting is "HI."

2. Select Hi(high) or Lo(low) with the Dial, the **2(AUDIO)** key, or ▲/▼ keys.
3. Press the **PTT** key to complete the setting and return to the frequency display.

*Note: This function does not work when receiving WFM. When the battery save function is set and starts to work, the audio output shifts to Lo (low). Then, above setting becomes null.*

## ■ Keylock

Hold the **FUNC/SET** key down for one second.

The key icon appears on the display, and the keylock turns on.

Release the keylock in the same way.

The following keys can be used while the keylock is ON.

**PTT**, **MONI**, **SQL(MONI (SQL) key + Dial)**, (**FUNC/LOCK + MONI**), **LAMP**.

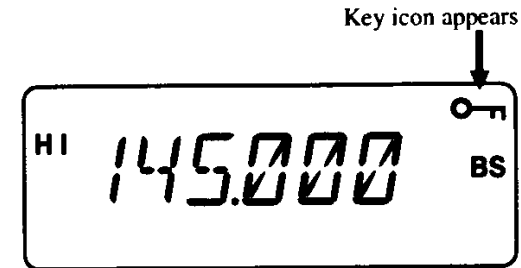
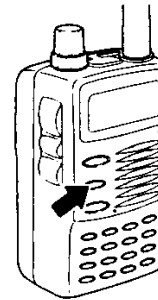

## ■ Lamp

- The DJ-V5 has lamps to light its display and keyboard.
- Press the **LAMP** key to turn them on. The lamps automatically turn off five seconds after pressing the **LAMP** key.
- The lamps keep lighting after any key operation and automatically turn off five seconds later.
- While the lamps are lit, press the **LAMP** key to turn the lamps off.
- If you press the **FUNC/LOCK** key, then the **LAMP** key, the lamps remain lit all the time even if power is turned off. To release this setting, press the **LAMP** key again.

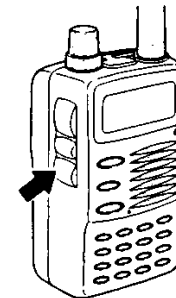

# 5 Communicating

## 5-1 Tone Squelch Frequency (CTCSS)

When using the tone squelch, and waiting to receive a signal, the squelch is unmuted only when the transceiver receives the tone frequency that you have selected for your station.

Tone squelch frequencies are assigned according to the international standards. 39 frequencies between 67 Hz and 250.3 Hz are available.

Tone encoder and Tone decoder list (39 frequencies, units : Hz)

67.0	69.3	71.9	74.4	77.0
79.7	82.5	85.4	88.5	91.5
94.8	97.4	100.0	103.5	107.2
110.9	114.8	118.8	123.0	127.3
131.8	136.5	141.3	146.2	151.4
156.7	162.2	167.9	173.8	179.9
186.2	192.8	203.5	210.7	218.1
225.7	233.6	241.8	250.3	

*Reference:* **Tone encoder frequency:**  
A frequency that adds a selected tone to a signal.  
**Tone decoder frequency:**  
A frequency for decoding a tone encoded signal  
These are used for unmuting the squelch during communication.

### ■ Setting Tone Encoder Frequency

1. Press the **FUNC/LOCK** key, then the **8(T · SQL)** key. "T" and the tone encoder frequency appear on the display.

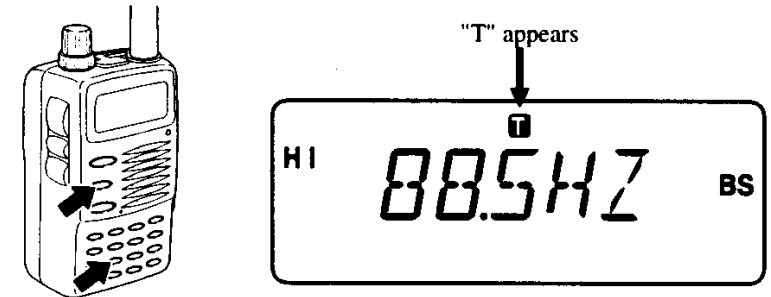

The default setting is 88.5 Hz.

2. Adjust the tone encoder frequency with the Dial or the **▲/▼** keys.
3. Press the **PTT** key to complete the setting and return to the frequency display.

## ■ Setting Tone Squelch Frequency

1. Press the **8(T · SQL)** key when the tone encoder frequency is indicated on the display.
2. "T · SQ" appears on the display. The common tone squelch frequency between the tone encoder and tone decoder is indicated on the display.

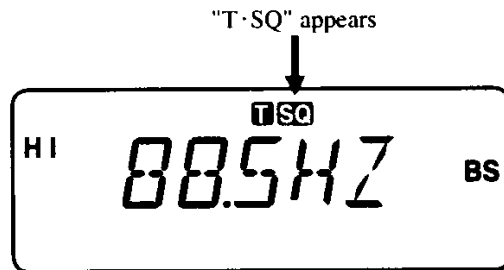

\*The default setting is 88.5 Hz.

3. Set the tone squelch frequency with the Dial or the **▲/▼** keys.
4. Press the **PTT** key to complete the setting and return to the frequency display.

*Reference:* 1 While the tone squelch frequency is indicated on the display, if the **8(T · SQL)** key is pressed, "OFF" appears on the display, and "T · SQ" disappears.

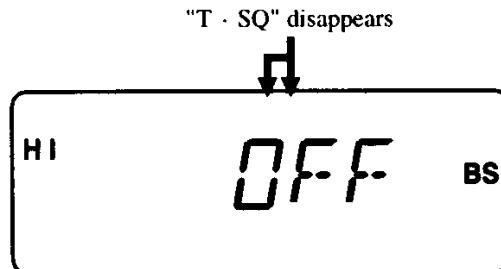

2 Press the **PTT** key to release the frequency setting.

*Note:* The tone frequency of the tone encoder and the tone frequency of the tone squelch may be different.

## ■ Transmitting and Receiving with a Tone Frequency

When "T" or "T · SQ" is indicated on the display, the tone signal is transmitted with the tone frequency.

When "T · SQ" is indicated on the display, the tone squelch unmutes only when tone signals match.

## 5-2 DTMF Squelch (DSQ)

This function unmutes the squelch by receiving a DSQ code programmed into a special purpose memory. This is an operation that is similar to the tone squelch.

The DSQ code is added to transmitted signals, and only stations that have a code that matches this code unmute their squelch.

### ■ Setting DSQ Code

1. Press the **FUNC/LOCK** key, then the **7(DSQ)** key. "DSQ" appears on the display.

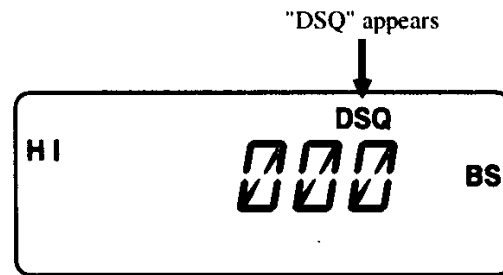

The default setting is 000.

2. Enter a three-digit number for the DSQ with keyboard.
3. Press the **PTT** key to complete the setting and return to the frequency display.

To revise the DSQ code, press the **FUNC/LOCK** key, then the **C(CALL/STEP)** key while the code is on the display. This returns the code to its default.

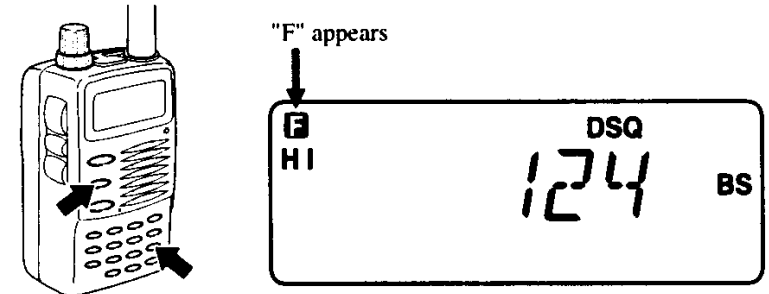

To turn the DSQ off, press the **FUNC/LOCK** key, then the **7(DSQ)** key while the DSQ code is on the display. "DSQ" disappears from the display.

### ■ Communicating Using DSQ Code

1. The squelch unmutes when receiving a signal which has the same three-digit code as the DSQ code that you programmed.
2. An alarm goes off, and "DSQ" flashes on the display.
3. Press the **PTT** key to transmit the three-digit code and respond to the transmitting station.

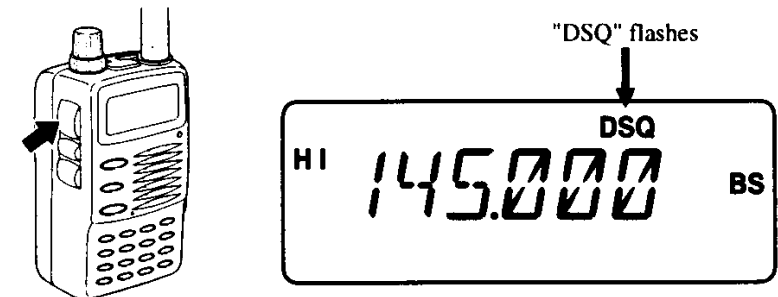

### ■ Attention When Using DSQ :

- When it is hard to receive the DSQ code, shorten the setting time of battery save in set mode, or turn battery save off. (page 32)
- When operating in DSQ mode, it is recommended that the battery save function be turned off. Alternatively, lengthen the wait time on the transmission side of DSQ code
- While Scan or Priority watch is working, DSQ setting is nullified, and "D · SQ" is not displayed.

## 5-3 Auto Dialer

This function automatically sends a pre-programmed DTMF code sequence.

### ■ Programming Dial Codes

1. Press the **FUNC/LOCK** key, then the **4(DIAL)** key. The auto dialer memory number appears on the display.

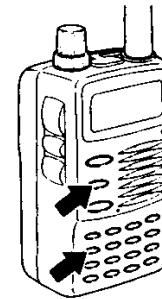

2. Select the auto dialer memory number from 0 ~ 7 with the Dial.
3. Enter a dial code with keyboard.  
The entered code appears at the right end, and the previously entered code moves to the left. The code can be up to 16 digits long, maximum.
4. Press the **PTT** key to complete the setting.

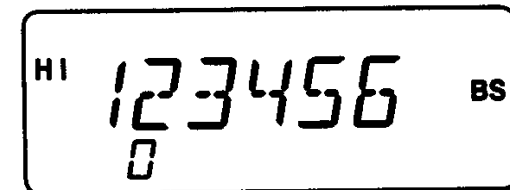
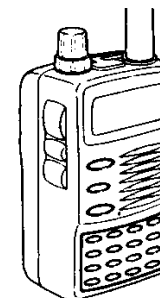

*Reference:* To move the digit, press the **FUNC/LOCK** key, then move the digit with the **Dial** or the **▲/▼** keys.  
It is not possible to enter the code when "F" is on the display.



## ■ Clearing the Dial Code

1. Press the **FUNC/LOCK** key, then the **4(DIAL)** key. The auto dialer memory number appears on the display.
2. Select an auto dialer memory number from 0 ~ 7 with the Dial.
3. Press the **FUNC/LOCK** key, then the **C(CALL/STEP)** key to clear.
4. Press the **PTT** key to complete the clearing operation.

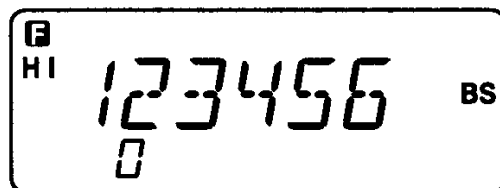
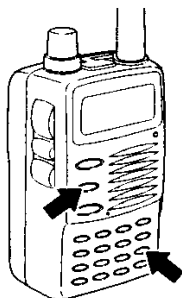

## ■ Sending the Auto Dialer Code

1. Press the **FUNC/LOCK** key, then **4(DIAL)** key. The display changes to the auto dialer display.
2. Select an auto dialer memory number with the Dial.
3. Press the **PTT** key to complete the setting.
4. Hold the **PTT** key down, and press the **FUNC/LOCK** key. The code will be transmitted automatically.

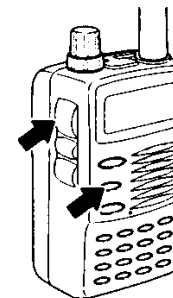

## ■ Outputting DTMF Codes Manually

Hold the **PTT** key down, and press any key on the keyboard. DTMF code correlating to the key that you press will be sent.

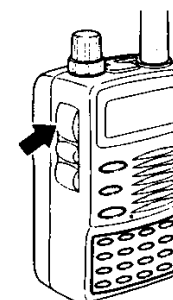

# 6 Maintenance and Reference

## ■ Troubleshooting

Please check the list below before concluding that the transceiver is faulty. If a problem persists, reset the transceiver. This can sometimes correct erroneous operation.

Symptom	Possible Cause	Action
Nothing appears on the display when you turn the power on.	Poor Ni-Cd battery pack or battery case connection.	Check that the battery pack (case) terminals are clean.
	Batteries are backward.	Check battery polarity.
	Dead battery.	Recharge or exchange batteries.
	You are releasing the key too quickly.	Hold the power switch down longer.
No speaker audio. No reception.	Volume too low	Adjust the volume.
	Squelch level too high	Adjust the squelch.
	Tone squelch is on	Turn off tone squelch.
	DSQ is on	Turn off DSQ.
	You are pressing the PTT key and transmitting.	Release PTT keys.
Frequency display is incorrect.	CPU error.	Reset
Won't scan.	Squelch is unmuted.	Set squelch so that noise is just muted.
Cannot run a programmed scan.	Programmed scan edges are not set correctly in memory.	Program upper and lower scan edges correctly.
Frequency and memory number do not change.	Keylock is on.	Turn off keylock.
	Transceiver is in the call mode.	Go to VFO mode.
Key entry not possible.	Keylock is on.	Turn off keylock.
One-touch repeater cannot be used.	Incorrect setting for one-touch repeater use.	Set the transceiver correctly for repeater use.
Cannot transmit. Display flashes or goes out when you transmit.	Battery is run down.	Recharge or exchange batteries
Cannot transmit. No reply when you transmit.	Not pressing PTT firmly enough.	Press the PTT key and confirm that TX/RX lamp lights red.
	You are off band. (when shift is set.)	Transmit within transmission frequency range.
	Incorrect frequency.	Match your frequency to receiving station frequency.

## ■ Resetting

When you reset the transceiver, all settings are returned to the initial factory settings. Existing memory channel settings will be lost.

1. Press the Power switch to turn the power on while the **BAND/SET** key is held down.  
Release the keys when "RESET \* " appears on the display.

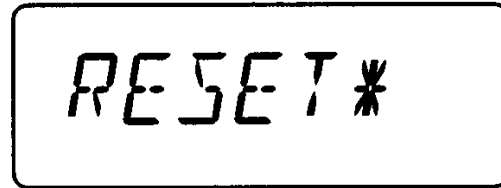
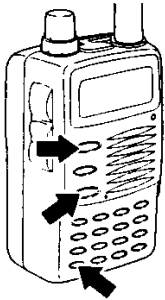

2. Press the \* (·/▼) key.  
The settings will be cleared automatically. Then they will return to the default settings and the transceiver will be in the VFO mode.

## ■ Factory Settings

VFO frequency	FM	DJ-V5T:88.100 MHz DJ-V5E:87.500 MHz
	VHF	DJ-V5T:145.000 MHz DJ-V5E:145.000 MHz
	UHF	DJ-V5T:445.000 MHz DJ-V5E:433.000 MHz
CALL frequency	C1	DJ-V5T:145.000 MHz DJ-V5E:145.000 MHz
	C2	DJ-V5T:445.000 MHz DJ-V5E:433.000 MHz
Programmed scan	None	
Memory channel	0-199ch Blank	
Tone, DSQ, APO, Keylock, Bell, Split, and Dial setting	OFF	
Shift range	VHF	0.6 MHz
	UHF	5.0 MHz
Tone frequency	88.5 MHz	
Tuning step	VHF/UHF	DJ-V5T:5kHz DJ-V5E:12.5kHz
	FM:	100kHz
Squelch level	1	
Scan resume conditions	Busy scan	
Transmit power	HI	
Battery save	ON(0.8 s)	
Beep	ON	

## Options

The following options are available for the DJ-V5.

EDH-29	:Battery case AA × 4pcs.
EBP-45N	:Rechargeable Ni-Cd battery pack (6.0V-700mAh)
EBP-46N	:Rechargeable Ni-Cd battery pack (9.6V-600mAh)
EDC-93	:Battery recharger (120V/AC input)
EDC-94	:Battery recharger (230V/AC input)
EDC-91	:Rapid recharger
EMS-8	:Remote control speaker microphone
EMS-9	:Speaker microphone
EMS-51	:Speaker microphone
EME-12	:Head set with VOX (headphones type)
EME-13	:Head set with VOX (inner type)
EME-15	:Tie-pin microphone with VOX
EME-4	:Earphone microphone
EME-16	:Earphone microphone
EME-17	:Earphone microphone
EME-6	:Earphone
EDC-36	:Cigarette lighter cable with filter (DC12V)
EDC-37	:DC cable for base station (DC12V)
EDC-43	:Cigarette lighter cable for recharging(DC12V)
ESC-35	:Softcase (for use with EBP-45N/46N)

### Reference of EMS-8(Remote control speaker microphone)

- ① **PTT** key :Same as the **PTT** key on the transceiver.
- ② **A** key :Can be allocated one of four functions.
- ③ **DOWN** key :Same function as rotating the transceiver's dial counter-clockwise.
- ④ **UP** key :Same function as rotating the transceiver's dial clockwise.

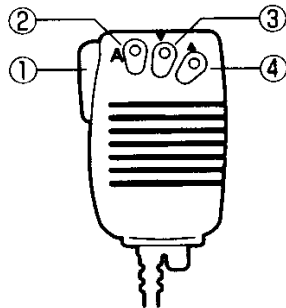

### A Key Function Allocation

1. Press the **FUNC/LOCK** key on the transceiver, then the **A** key on the microphone.
2. Select one of the following functions with the Dial or the ▲/▼ keys on the transceiver, or the **UP** or **DOWN** key.

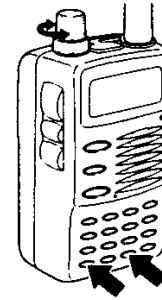

- 1:**LAMP** key
- 2:**MONI (SQL)** key
- 3:**A (V/M/MW)** key
- 4:**BAND/SET** key

The currently selected function appears on the display.

3. Press the **PTT** key on the transceiver, or the **A** key on the microphone, to return to the frequency display.

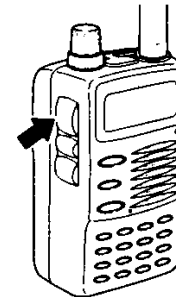

The **A** key will operate according to the function allocated to it.

## Packet Operation

Packet operation is used for data communication (from a computer, etc.).

### Packet Operation Connections

*Reference:* Connect the packet communication TNC (Terminal Node Controller) terminals to the SP ( $\phi$  3.5 mm plug) and MIC ( $\phi$  2.5 mm plug) connectors on the top of the transceiver.

- *Input level adjustment:* The transceiver has no MIC level adjustment circuit. Adjust the level on the TNC side.
- *Output level adjustment:* Use the volume dial on the top of the transceiver.

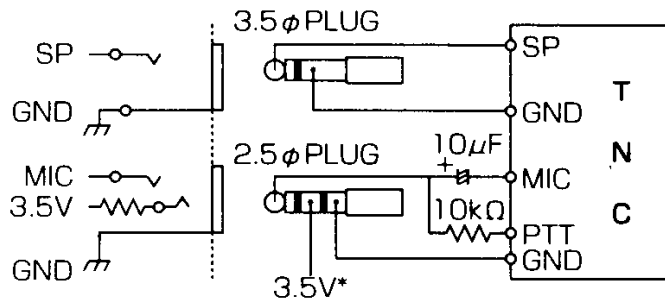

\* Power is supplied from internal 3.5V line through a 100  $\Omega$  resistor.

**⚠ Caution:** Refer to the TNC's instruction manual when connecting the TNC unit to other devices (personal computer etc.). If the transceiver, TNC unit and connected personal computer are too close together, noise between them may cause interference.

- Turn the battery save function off during packet operation.
- Confirm your frequency and your communicating partner's frequency. If the frequencies are OFF, the number of retries will be high, or communications may not be possible at all.
- Operate up to 1200 bps.

## Cloning

Using the cloning function, all setting information of one DJ-V5 (master) can be transferred to another DJ-V5 (slave).

1. Connect the mic jacks on both the master and slave transceiver.

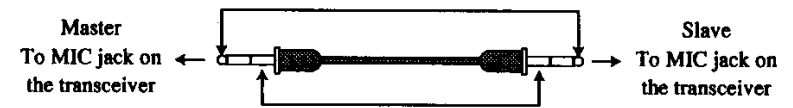

2. Turn on the power of both transceivers while the LAMP key is held down.

"CLONE" appears on the display of both transceivers.

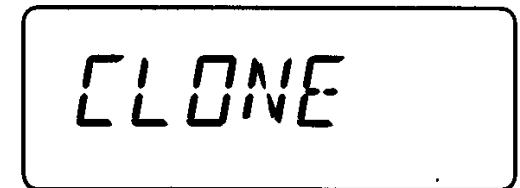
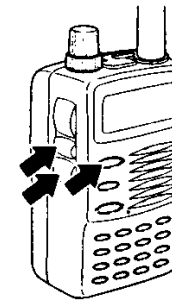

3. Press the MONI (SQL) key on the master transceiver.

"TX □□□□" appears on the master transceiver's display, and

"RX □□□□" on the slave transceiver's display.

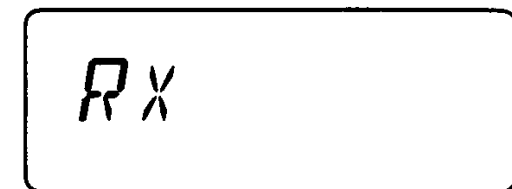
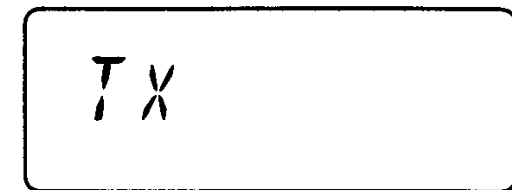

4. "PASS" appears on the both displays if the cloning completes correctly.

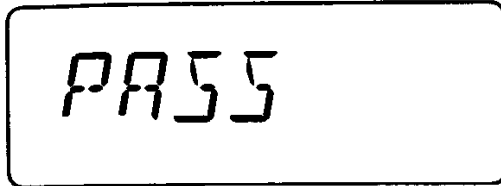

- If you want to clone the data to other transceivers, after completing one cloning operation, connect the master transceiver to another slave transceiver, and press the **MONI (SQL)** key on the master transceiver again.
- To return transceivers to normal use, turn the power off, then back on.

If incorrect data is transmitted in cloning, "ERROR" appears on both transceivers' displays.



If a communication error occurs, "COMERR" appears on both transceivers' displays.



When trying again, press the **MONI (SQL)** key on the master transceiver to resume cloning.

*Note:*

- *Do not disconnect the cable while cloning.*
- *All data in the slave transceiver will be updated if cloned. Be sure you want to change evrything before cloning.*
- *Do not press any key when transmitting data.*

## Transmission System

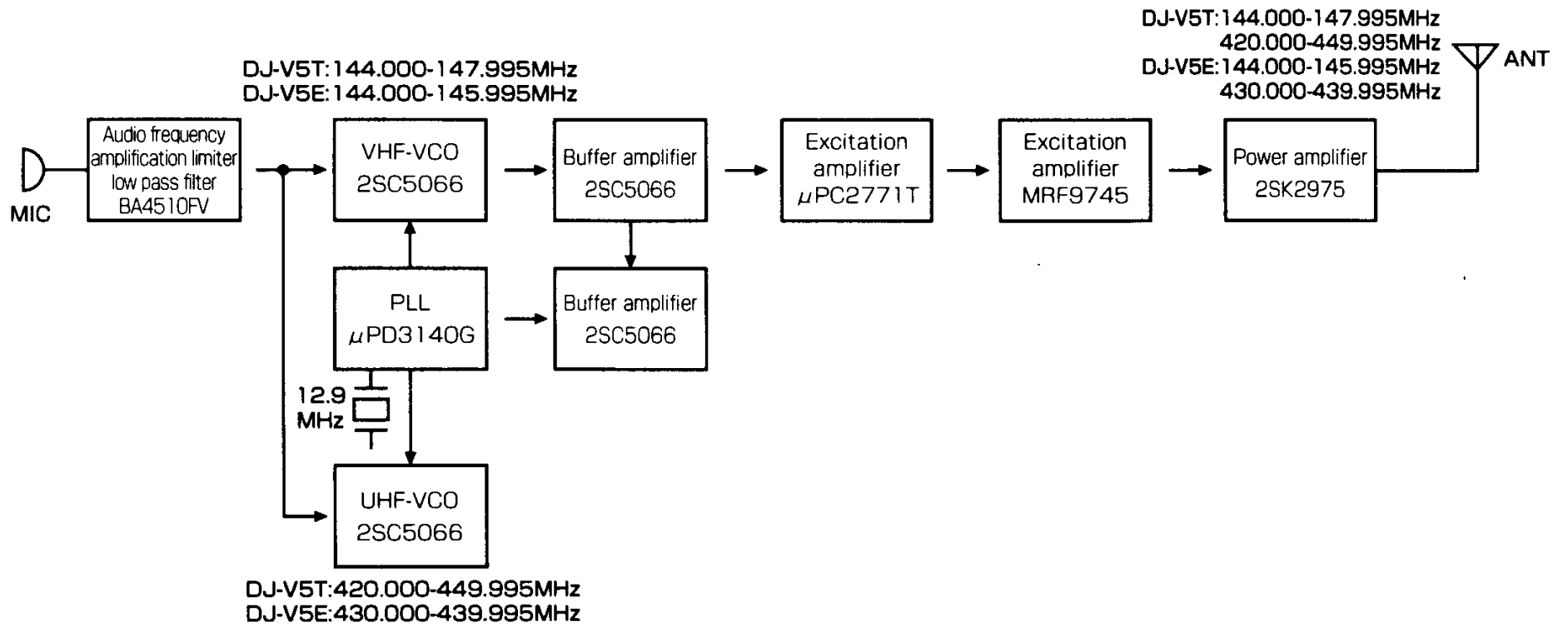

6

## Specifications

General		
Type	DJ-V5T	DJ-V5E
Receiving range	76-107.995MHz (Default:88.1MHz)	87.5-107.995MHz (Default:87.5MHz)
	144-147.995MHz	144-145.995MHz
	420-449.995MHz	430-439.995MHz
Transmitter range	144-147.995MHz	144-145.995MHz
	420-449.995MHz	430-439.995MHz
Modulation	F2, F3(FM), WFM(Reception)	
Frequency stability	$\pm 5\text{ppm}(-10^{\circ}\text{C}-+60^{\circ}\text{C})(+14^{\circ}\text{F}-+140^{\circ}\text{F})$	
Ant. impedance	50 $\Omega$	
Supply Voltage	Rating:DC 13.8 V Connection:DC 4.0-15.0V	
Ground	Negative ground	
Current consumption (DC 13.8 V, Average)	6W output:approx. 1.6A Rating output:approx. 220mA Squelch reception:approx. 70mA Battery save: approx. 20mA	
	Temperature range	
Dimension	W58×H97×D40.3mm (without projections, Battery case EDH-29inclusive) (2.28"×3.81"×1.58")	
Weight	Approx. 335g (Ant. battery case, 4 AA batteries inclusive) (0.74 lb, approx.)	

Transmitter		
Type	DJ-V5T	DJ-V5E
Power output	6W (1/0.5W)	
Modulation	Variable reactance	
Max. deviation	$\pm 5.0\text{kHz}$	
Spurious emission	-60dB or less	
Mic. impedance	Approx. 2k $\Omega$	

Receiver		
Type	DJ-V5T	DJ-V5E
System	Double-conversion superheterodyne	
First I.F.	FM:39.15MHz	
Second I.F.	FM:450kHz WFM:13.35MHz	
Sensitivity(12dBSINAD)	76-107.995MHz	87.5-107.995MHz
	WFM:0dB $\mu$	WFM:0dB $\mu$
	144-147.995MHz	144-145.995MHz
	FM:-16dB $\mu$	FM:-16dB $\mu$
	440-449.995MHz	430-439.995MHz
	FM:-15dB $\mu$	FM:-15dB $\mu$
Selectivity(except WFM)	-6dB/12kHz or over	
	-60dB/30kHz or less	
Spurious response	60dB or over	
AF output	500mW or over (8 $\Omega$ , 10% distortion factor, 13.8V)	
AF load impedance	8 $\Omega$	



# **ALINCO, INC.**

**Head Office:** "TWIN 21" MID Tower Building 25F  
1-61, 2-Chome, Shiromi, Chuo-ku, Osaka 540-8580 Japan  
Phone: 06-6946-8150 Fax: 06-6946-8175 Telex: 63086  
E-mail: 101243.1446@compuserve.com

**U.S.A.:** 438 Amapola Ave., Suite 130, Torrance, CA 90501-6201 U.S.A.  
Phone: 310-618-8616 Fax: 310-618-8758  
<http://www.alinco.com/>

**Germany:** Eschborner Landstrasse 55, 60489 Frankfurt am Main, Germany  
Phone: 069-786018 Fax: 069-789-60766