

ALINCO

VHF/UHF FM DUAL BAND HANDHELD TRANSCEIVER

DJ-560T/E

INSTRUCTION MANUAL

ALINCO ELECTRONICS INC.

438 Amapola Avenue, Unit 130, Torrance, CA 90501, U.S.A.
Phone: (213) 618-8616

1-1-1 Mishimae, Takatsuki city, Osaka 569, Japan

ALINCO ELECTRONICS INC.

TABLE OF CONTENTS

INTRODUCTION	3
1. ACCESSORIES	3
1-1. STANDARD ACCESSORIES	3
1-2. OPTIONAL ACCESSORIES	3
2. SPECIFICATIONS	4
3. CONTROL FUNCTIONS	5
3-1. TOP VIEW	5
3-2. FRONT, BACK and SIDE VIEWS	6
3-3. LCD DISPLAY	7
4. OPERATION	9
4-1. SELECTING THE MAIN (transmitting) BAND	9
4-2. OPERATIONAL MODES	9
4-3. FREQUENCY SELECTION	10
4-4. RECEIVING	11
4-5. TRANSMITTING	11
4-6. CALL CHANNEL	11
4-7. MEMORY	12
4-8. SCANNING	13
4-9. TONE BURST (DJ-560E ONLY)	14
5. FUNCTIONS	15
5-1. CHANNEL STEPS	15
5-2. SCANNING MODES	16
5-3. PRIORITY/DUAL WATCH FUNCTION	18
5-4. ENTERING AN OFFSET (SHIFT) FREQUENCY	19
5-5. SETTING A TONE FREQUENCY	20
5-6. SELECTING OFFSET (SHIFT) DIRECTION	21
5-7. REVERSE	21
5-8. TONE ENCODER AND TONE SQUELCH	22
5-9. DSQ FUNCTION I: PAGING	23
5-10. DSQ FUNCTION II (EXPANDED)	25
5-11. AUTOMATIC DIALER	27
5-12. AUTOMATIC BAND EXCHANGE (ABX)	28
5-13. BEEP AND BELL	28
5-14. MONO BAND	29
5-15. FREQUENCY LOCK (FL) AND KEY LOCK (KL)	29
5-16. PTT LOCK	29
5-17. LAMP	30
5-18. AUTOMATIC BATTERY SAVE (BS)	30
5-19. AUTOMATIC POWER OFF (APO)	30
5-20. SQUELCH (OFF)	30
5-21. RESET	31
5-22. VHF-UHF EXTERNAL SPEAKER JACK	31

INTRODUCTION

Congratulations, now you are the owner of one of our many "ALINCO" products. Your DJ-560T/E has been manufactured and tested very carefully at the factory and will give you satisfactory operation for many years.

1. ACCESSORIES

1-1. STANDARD ACCESSORIES:

Carefully unpack your transceiver and you will find the included with the transceiver.

- Ni-Cd Battery Pack (7.2 V, 700 mAh) EBP-10N
- AC Wall Charger for EBP-10N EDC-21 (120 V) for DJ-560T
EDC-17 (220/240 V) for DJ-560E
- Belt Clip
- Hand Strap
- Dual Band Rubber Flex Antenna

1-2. OPTIONAL ACCESSORIES:

- Ni-Cd Battery Pack (1.2 V, 700 mAh) EBP-12N
- AC Wall Charger for EBP-12N EDC-22 (120 V) for DJ-560T
EDC-18 (220/240 V) for DJ-560E
- Mobile DC Power Cable/Charger w/Noise Filter EDC-26
- Mobile DC Power Cable/Charger EDC-13
- Earphone EME-6
- Earphone/Microphone w/PTT EME-4
- Speaker/Microphone EMS-22
- Headset w/PTT/VOX EME-10
- Leatherette Case for DJ-560T/E w/EBP-10N ESC-11

2. SPECIFICATIONS

GENERAL

Frequency Coverage: See MODEL CHART
42 Channels (VHF/UHF 20 Channels Each & Independent Call Channels)

Signal Type: F3

Mic. Input Impedance: 2 k Ω

Speaker Impedance: 8 Ω

Power Supply Requirement: D.C. 7.2 V

Dimensions: 169 (H) \times 57 (W) \times 32 (D) mm
(6.65 \times 2.24 \times 1.23 inch)
Approx. 440 g (0.97 lbs.)

Weight:

TRANSMITTER

Output Power: 2 W with Standard EBP-10N
5 W with Optional EBP-12N

Modulation System: Variable reactance Frequency modulation
 \pm 5 kHz

Max. Freq. Deviation: Less than 60 dB below carrier

Tone Frequency: 67.0 to 250.3 Hz—38

DJ-560T—Subaudible Encoding Tone

DJ-560E—1,750 Hz Tone Burst

*CTCSS Decoder is included as standard Simplex.

Operation Mode:

Duplex: 5 kHz Steps (Minimum) between 0 and 9,995 MHz from receive frequency

*DTMF Encoder is included as standard

RECEIVER

Receiving System: Double-conversion superheterodyne

Sensitivity: 12 dB SINAD less than -15 dB μ

Intermediate Frequencies:

VHF	1st IF	55.05 MHz
	2nd IF	455 kHz
UHF	1st IF	58.125 MHz
	2nd IF	485 kHz

MODEL CHART

Type	DJ-560T	DJ-560E
Frequency Coverage (MHz)	VHF: 144,000–147,995 (TX) 130,000–173,995 (RX) UHF: 440,000–449,995 (TX) 400,000–519,995 (RX)	VHF: 144,000–145,995 (TX) 130,000–173,995 (RX) UHF: 430,000–439,995 (TX) 400,000–519,995 (RX)
Channel Spacing (kHz)	5, 10, 12.5, 20 and 25	5, 10, 12.5, 20 and 25
Tone Burst	Not Available	1,750 Hz
Subaudible	Included (Encode & Decode)	Included (Encode & Decode)
DTMF	Included (16 Buttons)	Included (16 Buttons)

3. CONTROL FUNCTIONS

3-1. TOP VIEW:

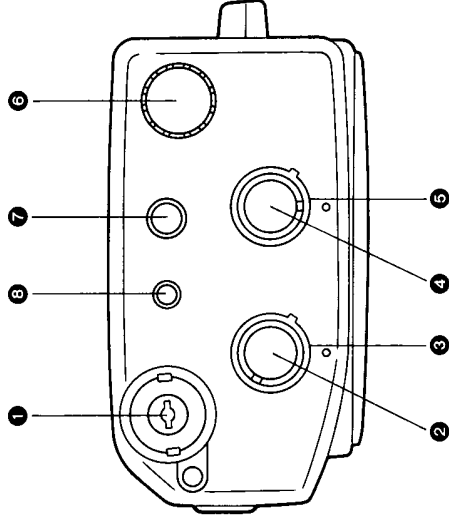

1 BNC Antenna Connector
Attach a suitable, low SWR 2 m/70 cm antenna to this connector.

2 VHF Volume Control
Rotate clockwise to increase VHF audio.

3 VHF Squelch Control
With no VHF signal present, adjust squelch control clockwise until background noise just disappears.

4 ON/OFF and UHF Volume Control
In the fully counterclockwise position, Power is OFF. Rotate clockwise to turn Power ON and to increase UHF audio.

5 UHF Squelch Control
Adjust the same as VHF squelch control (See 3 above).

6 Tuning Dial
Rotate in either direction to change VFO frequency by channel steps. Also changes Memory Channels in Memory mode.

7 Speaker Jack
An external speaker may be plugged into this jack. Built-in speaker is disabled when external speaker is in use.

8 MIC Jack
An external microphone may be plugged into this jack. Alinco optional accessories EME-4, EMS-2Z and EME-10 are recommended.

3-2. FRONT, BACK and SIDE VIEWS:

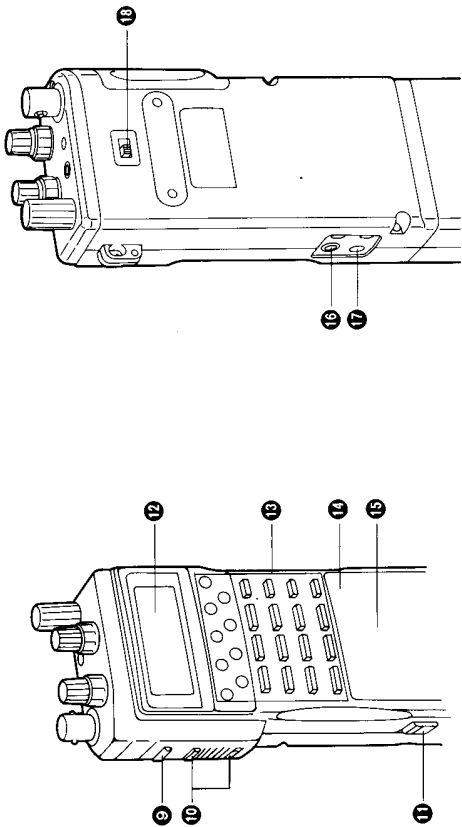

- ⑨ **Function Key**
The **FUNC** key accesses all secondary functions printed in green on the control key panel. Press and hold the **FUNC** key, "F" will appear on the LCD display, then press the desired command key. The **FUNC** key is also used to reset the DJ-560T/E (See 5-21).
- ⑩ **PTT (Press to Talk)**
Press and hold this button to transmit. Speak into microphone.
Note: On the DJ-560E the lower button transmits a Tone Burst, the upper button is the PTT (See 4-9). On the DJ-560T either button activates PTT.
- ⑪ **Battery Lock Button**
The battery lock button releases the battery from the radio. To attach the battery, position battery to the right until it locks in place. To remove the battery, slide up and hold the lock release button the slide the battery toward the charging jack side.
- ⑫ **LCD Display Panel** (See 3-3).
- ⑬ **Sixteen key multi-function command, control and DTMF keypad.**
- ⑭ **Microphone**
An electret condenser microphone is built in. When transmitting, speak into microphone from a distance of approximately 5".
- ⑮ **Speaker**
- ⑯ **VHF/UHF Dual External Speaker Jack** (See 5-22).
- ⑰ **DC IN Jack**
Plug an external 13.8 V power source into this Jack. Observe correct plug polarity. Alinco optional accessories EDC-13 or EDC-26 are recommended.
- ⑱ **H/L (High/Low) Transmit Power Switch**
"H" is High transmitter output power and "L" is Low transmitter output power.

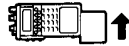

3-3. LCD DISPLAY

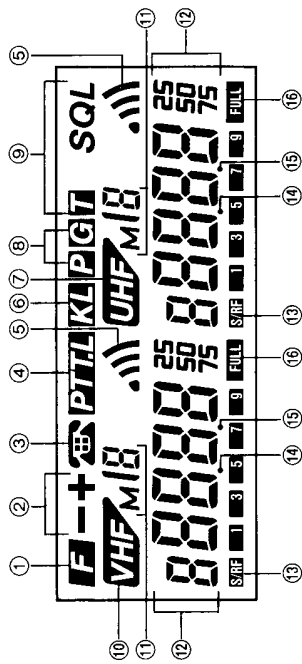

- ① **FUNCTION ("F")**
The **FUNC** key is used to access the secondary functions printed in Green on the command and control function keys. When the **FUNC** key is pressed the "F" symbol appears on the LCD display indicating that FUNCTION is active.
- ② **"+/-" TRANSMITTER OFFSET SHIFT**
To select automatic transmitter offset shift press and hold the **FUNC** key then press the **+** key until desired offset indicator appears on the LCD display. See 5-4 and 5-6.
- ③ **DIAL**
The "DIAL" symbol appears on the LCD display when the automatic telephone dialer function is activated. In this mode telephone numbers up to sixteen numbers, characters and letters may be stored and transmitted automatically. See 5-11.
- ④ **PTT.L (Press-To-Talk Lock)**
The "PTT.L" symbol indicates that the **PTT** switch is locked and the radio will not transmit even if the **PTT** switch is pressed accidentally. See 5-15.
- ⑤ **BELL**
The "BELL" symbol indicates that the BELL function is active. In this mode the "BELL" symbol flashes and an audible tone alert sounds when a signal is received. See 5-13.
- ⑥ **KL (Key Lock)**
When the KL function is active most of the command and control function keys are locked out and will not operate even if they are pressed accidentally. See 5-15.
- ⑦ **UHF**
This symbol indicates that UHF has been selected as the Main Band. See 4-1.
- ⑧ **DSQ (DTMF Squelch)**
In this mode the DSQ function is accessed. Various DTMF tone squelch functions may be selected and activated. See 5-9.
- ⑨ **T SQL (Tone Encoder/Tone Squelch)**
These symbols appear when the Tone Encoder and Tone Squelch functions are activated. See 5-8.
- ⑩ **VHF**
When this symbol appears VHF has been selected as the Main Band. See 4-1.



① **MEMORY CHANNEL**

This symbol indicates that the selected band is in Memory Mode and displays the memory channel number. (See 4-7).

⑫ **FREQUENCY**

Receive and transmit frequencies, offset and tone frequencies, channel steps, DSQ codes and dialer memory numbers are displayed in this area depending on the selected mode.

⑬ **S/RF**

In the receive mode the S/RF (Signal/RF) bars indicate received Signal strength. While transmitting the S/RF bars indicate transmitter RF power output.

⑭ **FREQUENCY DECIMAL POINT**

When receive, transmit or offset frequencies are displayed on the LCD the decimal point divides MHz and kHz.

⑮ **STONE FREQUENCY DECIMAL POINT**

When a Tone frequency is displayed the decimal point divides Hz and 0.1 Hz.

⑯ **FULL**

This symbol will appear whenever either received signal or transmitter power output are at their maximum.

4. OPERATION

4-1. SELECTING THE MAIN (transmitting) BAND

The DJ-560T/E can receive on both bands simultaneously. It transmits on the selected Main Band. All LCD displays, except the frequencies, indicate settings and key operations for the Main Band.

OPERATION

To select UHF as the Main (transmitting) Band, press the UHF key. The UHF will appear and UHF becomes the Main Band. VHF is selected as the Main Band by pressing the VHF key. The VHF will appear and VHF becomes the Main Band. At the initial factory setting, and after reset, VHF is the Main Band.

ABX OPERATION

The Main Band may also be selected automatically by activating ABX feature. In the ABX mode the sub-band becomes the Main Band by automatic switching when it becomes active. (See 5-12).

4-2. OPERATIONAL MODES

VFO MODE

Operating frequencies, key settings, functions, Band Scan, Program Scan and VFO Priority are selected in the VFO mode. To access the VFO mode from the Memory mode or the Call Channel mode press either the VFO key or the VFO key depending on which is the desired Main Band.

MEMORY MODE

Each band has 20 memories (0 through 19). In the Memory mode memory channels may be retrieved for use and the Memory Scan and Memory Priority modes may be activated. To access the Memory mode from the VFO or the Call Channel modes, press the MEM key.

CALL CHANNEL

Each band has one Call Channel. In this mode the Call Channels may be retrieved for use. Both Call Channels may be monitored simultaneously. To return to the VFO or the Memory modes press the VFO key.

4-3. FREQUENCY SELECTION

INITIAL SETTINGS

Initial factory channel step settings for the DJ-560T/E are 5 kHz for the US model and 12.5 kHz for the European model.

TUNING DIAL

Press the \odot or the \odot key to select the Main Band. Rotating the tuning dial clockwise increases the frequency one channel step for each click. Counterclockwise rotation decreases the frequency one channel step for each click.

If the **FUNC** key is pressed and held, the "F" will appear on the LCD and frequency will increase or decrease 1 MHz depending on direction of tuning dial rotation.

UP/DOWN KEYS

Channel Step

1. Press the \uparrow key once to increase frequency one channel step.
2. Press the \downarrow key once to decrease frequency one channel step.

100 kHz Step

1. Press the \uparrow key once to increase frequency 100 kHz
2. Press and hold the **FUNC** key, then press the \uparrow key once to decrease frequency 100 kHz.

1 MHz Step

1. Press the \uparrow key once to increase frequency 1 MHz.
2. Press and hold the **FUNC** key, then press the \uparrow key once to decrease frequency 1 MHz.

NOTE

When either the \uparrow or \downarrow keys is pressed and held, frequency will change continuously in the selected direction. When key is released after continuous frequency change has started, scanning by channel steps will begin. (See 4-8, Scanning Function).

KEY PAD DIRECT ENTRY

When frequency is selected by key pad direct entry, numbers will appear on the LCD display as they are entered on the key pad.

To enter frequency directly from key pad, press \odot or \odot to select desired Main Band then:

1. Enter the 100 MHz number. **VHF** or **UHF** will begin to flash depending on the selected Main Band.
2. Enter the 10 MHz number.
3. Enter the 1 MHz number.
4. Enter the 100 kHz number.
5. Enter the 10 kHz number. If radio is in 10 kHz or higher step, a beep will sound, the **VHF** or **UHF** will stop flashing and the entry is completed.
6. Enter the kHz number if the radio is in the 5 kHz step setting. A beep will sound, the **VHF** or **UHF** will stop flashing and the entry is completed.

CANCELLATION WHILE SELECTING

Press either the \odot or \odot key, whichever is the Main Band, to cancel key pad entry while selecting. The entry will be cancelled and the former frequency will be displayed. Entry may also be cancelled by pressing the **PTT** switch.

4-4. RECEIVING

1. Turn on power with the UHF volume control.
2. Adjust VHF and UHF volume controls to desired level.
3. Adjust both squelch controls until background noise disappears.
4. Select desired Main Band, then select frequency. When a signal is received the S/R/F signal level bars will appear, indicating received signal strength, and the voice will be heard.

4-5. TRANSMITTING

The DJ-560T/E transmits on the Main Band only.

Transmitting Procedure

1. Select VHF or UHF as the Main Band for transmitting.
2. Select the desired frequency.
3. Press and hold the **PTT** switch to transmit. Speak into microphone from a distance of approx. 5".
4. Release the **PTT** switch to return to receive.

Transmitter Power Output Selection

1. Select either High (H) or Low (L) transmit power with the H/L switch on the back of the radio.
2. Caution! To avoid UHF receive interference while transmitting on VHF ensure that the UHF frequency is not exactly three times the VHF frequency. For example, if VHF transmit frequency is 146.190 the UHF frequency should not be set at 438.570.

4-6. CALL CHANNEL

Each band has one Call Channel which is immediately accessible by pressing the \odot key. An often-used frequency of interest, such as a preferred local repeater, is usually programmed into the Call Channel.

The initial factory VHF Call Channel setting is 145.000 MHz. The initial factory UHF Call Channel settings are 445.000 MHz for the US model (DJ-560T) and 433.000 MHz for the European model (DJ-560E).

Entering A Frequency Into The Call Channel

1. Select the Main Band and enter the desired Call Channel frequency into the VFO.
2. Press and hold the **FUNC** key. "F" will appear on the LCD.
3. Press the \odot key. "C" will appear on the LCD indicating that the frequency is now stored in the Call Channel and the radio is now in the CALL mode.

Accessing The Call Channel

1. Select the desired Main Band.
2. Press the \odot key. "C" will appear on the LCD and the Call Channel will be accessed.
3. Press the \odot key again to return to the previous frequency and mode.
4. Caution! If the \odot key is pressed and held for more than five seconds, Call Dual Watch will begin. (See 5-3).





Changing The Frequency In The Call Channel

1. Select the desired Main Band.
2. Press the \odot key to retrieve the Call Channel.
3. Enter the new frequency. Repeat steps 2 and 3 under "Entering A Frequency Into the Call Channel" (above).

4-7. MEMORY

The DJ-560T/E has a total of 40 memories, 20 for each band. No frequencies are programmed into any memory as part of the factory initial settings. A flashing "M" on the LCD indicates nothing is programmed into that memory channel. The displayed frequency is in the VFO.

Entering A Frequency Into A Memory Channel

1. Select either VHF or UHF as the Main Band.
2. Press the  key to put the Main Band into Memory mode. "M" and a memory channel number (0-19) will appear. "M" will flash if nothing has been programmed into the displayed memory. A steady "M" indicates that the displayed frequency is stored in that Memory Channel number.
3. Press the  key until the desired Memory Channel number appears on the LCD display. The tuning dial may also be used to select a Memory Channel number in the Memory mode.
4. Return to VFO mode by pressing the appropriate Main Band key.
5. Enter frequency to be memorized into the VFO.
6. Enter other functions into the VFO (See next paragraph).
7. Press and hold the  key, then press the  key. The VFO frequency is now stored in the selected Memory Channel and the radio is in the Memory mode.

What Can Be Stored In Memory

1. Frequency
 2. Shift (offset) direction: plus (+), minus (-) or simplex.
 3. Subaudible tone encoder "T"
 4. Tone squelch "T SQL"
 5. Tone frequency
 6. Shift (offset) frequency
- All these functions can be stored in any Memory Channel and in either Call channel. Desired functions are entered into memory along with frequency when a Memory Channel number has been selected and the radio is in VFO mode before the  key is pressed. (See 5 and 6 above.)



4-8. SCANNING



Band Scan

In this mode the DJ-560T/E band scans by Channel Step, by 100 kHz steps or by 1 MHz steps. As the scan passes through any 500 kHz or 1 MHz point a tone will sound if the BEEP function is active.

Channel Step Scanning



Upward Scanning
1. Select the band to be scanned as the Main Band.

2. Press the  key. Frequency will cycle upward by channel steps as long as the  key is held.

3. When frequency up cycle begins release the  key. The frequency decimal point will flash indicating that scanning has begun. Scanning will not begin while  key is held.

4. When a signal is received scanning will stop and remain on that frequency.

5. To resume scanning rotate the tuning dial clockwise to start upward scan, counterclockwise to start downward scan.

6. To stop scanning press either the  or the  key.

Downward Scanning



1. Select Main Band to be scanned.
2. Press the  key and repeat Steps 3-6 above.

100 kHz Step Scanning

Upward Scanning

1. Select band to be scanned.
2. Press the  key.
3. Follow Steps 3-6 in Channel Step Scanning.

Downward Scanning



1. Press and hold the  key, the press the  key.
2. Follow Steps 3-6 in Channel Step Scanning.

1 MHz Step Scanning

Upward Scanning

1. Select band to be scanned.
2. Press the  key.
3. Follow Steps 3-6 in Channel Step Scanning.



Downward Scanning

1. Press and hold the  key, then press the  key.
2. Follow Steps 3-6 in Channel Step Scanning.

Changing A Memory Channel Frequency

1. Select the band in which the memory frequency is to be changed as the Main Band.
2. Press the  key to put the Main Band in Memory mode.
3. Select the Memory Channel number to be changed.
4. Return the Main Band to VFO mode.
5. Enter new frequency and functions into VFO.
6. Complete Step 7 under "Entering A Frequency Into A Memory Channel" (above).

Cancelling A Memory Channel Frequency

1. Select desired Main Band, then select Memory mode. Confirm "M".
2. Press and hold the  key, then press the  key. "M" will begin to flash indicating the Memory Channel is now empty. The former memory frequency is now the VFO frequency.

Memory Scan

In the Memory Scan mode only memories with stored frequencies are scanned. Empty memories and memories programmed to SKIP are ignored. If only one memory has a stored frequency Memory Scan will remain on that memory. The frequency decimal point flashes during scanning as it does in all SCAM modes.

Upward Scanning

1. Select the band to be scanned as the Main Band.
2. Press the \uparrow key.
3. While \uparrow key is held memories will cycle upward. When upward cycle begins release the \uparrow key. Frequency decimal point will flash indicating UP SCAN has begun. Scanning will not begin until \uparrow key is released.
4. When a signal is received scanning will stop and remain on that Memory Channel.
5. To resume scanning rotate the tuning dial clockwise to start upward memory scan, counterclockwise to start downward memory scan.
6. To stop Memory Scan press the \uparrow key.

Downward Scanning

1. Select band to be scanned.
2. Press and hold the \downarrow key, then press the \uparrow key.
3. Follow Steps 3–6 above.

Memory Skip

Memory skip allows any unwanted memories to be skipped during Memory Scanning.

Skipping A Memory

1. Press the \uparrow key to cycle through memory channels until the memory channel to SKIP appears.
2. Press and hold the \downarrow key, then press the \downarrow key.

The frequency decimal point will disappear and the unwanted memory channel will be skipped during Memory Scanning.

3. To restore a memory channel programmed to SKIP repeat Step 2. Frequency decimal point will reappear and the memory will be scanned.

4-9. TONE BURST (DJ-560E only)

Many European repeaters require a 1,750 Hz tone burst to access the repeater. To transmit a tone burst press the tone burst button.

5. FUNCTIONS

5-1. CHANNEL STEPS

Channel steps may be set independently for each band.

Setting Channel Steps

1. Select VHF or UHF as the Main Band.
2. Press and hold the \downarrow key, then press the \downarrow key.
3. With the \downarrow key depressed, the Channel Step will change each time the \downarrow key is pressed. Channel Steps may also be changed by rotating the tuning dial or by pressing the \downarrow key or the \downarrow key.
4. Channel Steps change in the following increments:

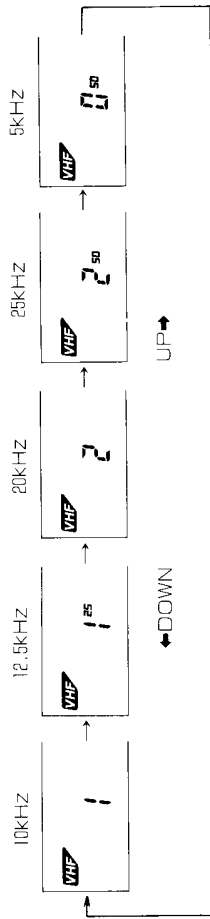

5. Press the \downarrow or the \downarrow key, whichever is the Main Band, or the \downarrow switch to return to the operating frequency. The Channel Step is now set.
6. Rotating the tuning dial or pressing the \downarrow or \downarrow keys will now change the VFO frequency by the set Channel Step. VFO band scan frequency will also change by the set channel step.

Actions

three available
reversed during
ing dial in the
r up scan and
an.

during upward
am Scan mode
0 kHz.
kHz, press the
key.
00 kHz.

canning modes
ng the  switch or the

Notes

the same time in
action. To scan
the first band to
Select desired
select the other
ired scan mode

y mode and in
one band does
If either or both
the radio was
canning modes
rned on again.

Priority Function

while scanning,
Priority. In this
e active at the
erefe with the

5-3. PRIORITY/DUAL WATCH FUNCTION

VFO Priority

In this mode a VFO frequency is received for three seconds and a Memory frequency is received for one second in a continuous cycle.

1. Select either VHF or UHF as the Main Band.
2. Press the VFO key to activate Memory mode.
3. Rotate the tuning dial or press the VFO key to select desired Memory channel number.
4. Press either the VHF or the UHF key to return to desired Main Band VFO.
5. Enter desired VFO frequency.
6. Press the PTT key to begin the Priority function. In this mode the radio listens alternately to the VFO frequency for three seconds and to the Memory frequency for one second.
7. When a signal is received on the Memory frequency a BEEP will be emitted, "  ". appears on the LCD display and the signal is held for three seconds.
8. To stop the Priority function press the PTT key in VFO mode.

Memory Priority

This mode is the reverse of VFO Priority. The Memory frequency is received for three seconds and the VFO frequency is received for one second.

1. Select either VHF or UHF as the Main Band.
2. Enter desired VFO frequency.
3. Press the VFO key to access the Memory mode.
4. Rotate the tuning dial or press the VFO key to select desired Memory Channel.
5. Press the PTT key to start the Priority function. The radio will listen alternately to the Memory channel for three seconds and to the VFO for one second in repeating cycles.
6. When a VFO signal is received a BEEP will be emitted, "  " appears on the LCD and the signal is held three seconds.
7. Press the PTT key to stop the Priority function.

Operations while Priority Function Is Active

In either VFO Priority or Memory Priority the transmitter may be activated on either frequency. Press the PTT switch when the desired frequency is displayed on the LCD. When the PTT switch is released the Priority function resumes.

Changing the VFO frequency or the Memory channel during the three second scan cycle.

1. Rotate the tuning dial or press either the VHF or UHF key to increase or decrease the VFO frequency or the Memory channel.

To Stop the Priority function press the PTT key or press the PTT during the one second cycle.

Simultaneous Priority On Both Bands

While the Priority function is active on either band Priority may be activated on the other band at the same time.

1. Press either the VHF key or the UHF key to select the band not in Priority.
2. Refer to 5-3, VFO Priority or Memory Priority, to set up and start the desired Priority mode on the second band.
3. Dual independent Priority will now function on both bands.
4. The transmitter will function on whatever frequency is displayed on the LCD during the Main Band cycle when the PTT is pressed. Wait for the desired transmit frequency to appear.
5. Press the PTT key again to stop dual Priority.

Simultaneous Priority And Scan

Either the VFO or the Memory channels may be scanned while the Priority/Dual Watch function is active. Scan may also be started before Priority is activated.

1. Start scan while either the VFO frequency or the Memory channel is displayed on the LCD. Whichever is displayed will begin to scan and the Priority function will continue while scanning.
2. The transmitter will function on whatever frequency is displayed on the LCD during the Main Band cycle when the PTT is pressed. Wait for the desired transmit frequency to appear.
3. Press the PTT key again to stop simultaneous Priority and Scan.

Call/Dual Watch

In this mode the Dual Watch cycles between the CALL frequency and another frequency selected from the VFO or the Memory channels.

1. Select the Main Band.
2. If a CALL frequency has not previously been stored in the CALL channel, select and store a CALL frequency (See 4-6).
3. Select either a VFO frequency or a Memory channel on the LCD.
4. Press the CALL key for more than 1/2 second. CALL Dual Watch will begin to cycle between the CALL channel and the selected VFO frequency or Memory channel.
5. Press the PTT switch to transmit on the displayed frequency.
6. The CALL Dual Watch function is cancelled by pressing the PTT or by pressing the CALL key again.

5-4. ENTERING AN OFFSET (SHIFT) FREQUENCY

Almost all repeaters operate in the duplex mode. They receive on one frequency and transmit on another frequency. The difference between these frequencies is the offset, or shift, frequency. The published repeater frequency is usually the repeater transmit frequency. This is the repeater frequency the repeater user selects on the LCD display.

The repeater user transmits on a frequency offset either above or below the repeater frequency. The standard offset for the 2 meter band is 600 kHz. For the 70 cm band the standard offset is 5 MHz. Offset direction varies according to established Band Plans.

Once the offset frequency and direction have been programmed into the DJ-560T/E they are automatically selected each time the PTT switch is pressed on either band.

1. To enter an offset frequency first select either VHF or UHF as the Main Band.
2. Press and hold the FUNC key, then press the OFFSET key. An offset frequency will be displayed on the LCD. The initial factory offset frequency settings are:

DJ-560T	DJ-560E
VHF: 600 kHz (0.60)	VHF: 600 kHz (0.60)
UHF: 5 MHz (5.00)	UHF: 7.6 MHz (7.60)

Only in rare instances will it be necessary to change these initial factory offset frequency settings.

3. When the desired offset frequency has been selected the LCD display is returned to the repeater frequency by pressing the Main Band key or the PTT switch.

Selecting An Offset Frequency

- Repeat Steps 1 and 2 above to display the offset frequency on the LCD.
- The factory initial setting for the selected Main Band will appear. For VHF the standard 600 kHz offset is shown as 0.60. The standard UHF 5 MHz offset appears as 5.00.
- Unless a non-standard offset frequency is required the factory settings may be left unchanged.
- Offset frequency may be changed by pressing either the \uparrow key or the \downarrow key for small incremental changes by the channel step at a time. The tuning dial may also be used to change frequency in either direction.
- For larger incremental frequency changes press either the Φ key or the Ψ key to increase frequency 100 kHz or 1 MHz each time the key is pressed.
- Press and hold the FUNC key then press either the Φ key or the Ψ key for larger incremental frequency decrease.
- To return to the displayed repeater frequency press either the Main Band key or the PTT switch.

5-5. SETTING A TONE FREQUENCY

Access to an increasing number of repeaters is restricted by requiring that a sub-audible tone be transmitted with the input signal to open the repeater. A repeater control operator and most repeater users can advise which of the 38 standard tones will activate a specific repeater.

- Select the Main Band then press and hold the FUNC key. "F" will appear on the LCD display.
- Press the \uparrow key. A Tone Frequency will appear.
- Select desired Tone Frequency by rotating the tuning dial or by pressing either the \uparrow key or \downarrow key.
- Press the FUNC key or the PTT key to return to the Main Band frequency.
- The Tone Frequency is now stored and will be transmitted with the repeater input frequency.

67.0	71.9	74.4	77.0	79.7	82.5
85.4	88.5	91.5	94.8	97.4	100.0
103.5	107.2	110.9	114.8	118.8	123.0
127.3	131.8	136.5	141.3	146.2	151.4
156.7	162.2	167.9	173.8	179.9	186.2
192.8	203.5	210.7	218.1	225.7	233.6
241.8	250.3				

Sub-audible Tone Chart

5-6. SELECTING OFFSET (SHIFT) DIRECTION

[See 5-4 for explanation of Offset (transmit offset frequency).]

- Select the desired Main Band.
- Press the FUNC key, then press the \uparrow key until the desired offset symbol appears on the LCD display.
- A "+" symbol indicates an UP transmitter offset.
- A "-" symbol indicates a DOWN transmitter offset.
- When neither a "+" nor a "-" symbol appears the transmitter is in the Simplex mode and will transmit on the receive frequency.
- If "FFF" appears in place of the frequency during transmit the selected offset frequency is out-of-band. The transmitter will not transmit. Reset the offset direction and frequency.

5-7. REVERSE

This function reverses the Transmit and Receive frequencies. The transmit frequency becomes the receive frequency and the receive frequency becomes the transmit frequency. The REVERSE function is useful to determine if the other station is within Simplex range. It is also used to set up the radio to operate on a repeater with the exact reverse frequencies of a repeater already in use or programmed into a Memory channel.

CAUTION!

- If the transmit frequency is out-of-band after the frequencies have been reversed, the transmitter will not transmit and a BEEP will sound.
- The radio cannot transmit on the following frequencies after REVERSE (10-0.1 kHz). It will transmit as follows:

Actual transmit frequency
***, *02.5 kHz
***, *07.5
***, *17.5
***, *22.5
***, *27.5
***, *32.5
***, *42.5
***, *47.5
***, *52.5
***, *57.5
***, *67.5
***, *72.5
***, *77.5
***, *82.5
***, *92.5
***, *97.5
***, *00.0 kHz
***, *05.0
***, *15.0
***, *20.0
***, *25.0
***, *30.0
***, *40.0
***, *45.0
***, *50.0
***, *55.0
***, *65.0
***, *70.0
***, *75.0
***, *80.0
***, *90.0
***, *95.0

5-8. TONE ENCODER AND TONE SQUELCH

The Tone Squelch function is standard on the DJ-560T/E. Tone Squelch and Tone Encoder work on the Main Band only.

Setting Tone Encode and Tone Squelch

1. Select desired Main Band.
2. Press the $\boxed{\text{TONE}}$ key. Tone settings will cycle each time the $\boxed{\text{TONE}}$ key is pressed as follows:

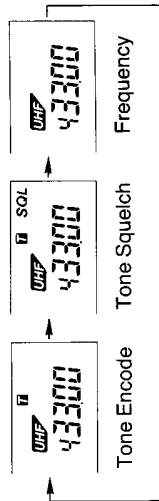

3. Caution! When the Tone Encode/Tone Squelch functions have been set they follow the Main Band. Individual Tone Encode/Tone Squelch frequencies may be selected for each band.

Setting The Tone Encoder

1. Select desired Main Band.
2. Press the $\boxed{\text{TONE}}$ key until "T" appears above the UHF frequency on the LCD display.
3. Press and hold the $\boxed{\text{TONE}}$ key, then press the $\boxed{\text{TONE}}$ key. A tone frequency will appear on the Main Band LCD display.
4. Select desired tone frequency by rotating the tuning dial in either direction or by pressing the $\boxed{\text{UP}}$ or $\boxed{\text{DN}}$ key.
5. Return to the Main Band by pressing either the Main Band key or the PTT switch.
6. The encoded tone frequency is now stored and will be transmitted with the transmitter output frequency when the "T" is present on the LCD display.
7. To stop the Tone Encoder function press the $\boxed{\text{TONE}}$ key until the "T" disappears from the LCD display. The encoded tone is not transmitted until "T" is returned to the LCD display.

Tone Squelch

This function is used to open the receiver squelch whenever another station transmits the tone frequency the DJ-560T/E is programmed to receive. In the Tone Squelch mode the listener may monitor a busy channel silently. Only signals transmitting the Tone Squelch frequency to which the listener's DJ-560T/E is set will open the squelch and be heard. Individual Tone Squelch frequencies may be selected for each band.

1. Select desired Main Band.
2. Press the $\boxed{\text{TONE}}$ key until "T SQL" appears above the UHF frequency on the LCD display.
3. Press and hold the $\boxed{\text{TONE}}$ key, then press the $\boxed{\text{TONE}}$ key. A tone frequency will appear on the Main Band display.
4. Repeat Steps 4 and 6 above.
5. The Tone Squelch frequency is now stored. Only signals transmitted with the selected Tone Squelch code will be heard.
6. Ensure that stations the listener wishes to hear are transmitting the correct Tone Squelch code or they will not be heard.
7. Stop Tone Squelch by pressing the $\boxed{\text{TONE}}$ key until "T SQL" disappears from the LCD.
8. All signals received on the monitored frequency will now be heard until Tone Squelch is deactivated.

5-9. DSQ FUNCTION I: PAGING

This mode is used for paging or code squelch.

Group Calling

Use this mode to call all members of a specific group.

Private Call in A Group

In this mode a single person in a group is called.

DSQ Codes

1. 3 Digit Group Code.
This code is common to all members of the group.
2. Single Digit "Own" Code.
This is a personal code to receive private calls in a group.
3. Single Digit "Others" Code.
This code is used to call a specific person in the group. It is the other person's private code.
4. Single Digit Monitor Code.
When "own" paging code is received the "other's" private code can be memorized.
5. 16 numbers, letters and symbols can be used for the codes. They are: $\boxed{0}$ \rightarrow $\boxed{9}$, \boxed{A} \rightarrow \boxed{D} , \boxed{E} and \boxed{F} . An "H" will appear on the LCD when \boxed{E} is entered and "M" appears when \boxed{F} is entered. \boxed{H} is used as a "Wild Card". (See 5-9, DSQ II).

Setting DSQ

1. Select the Main Band.
2. Press and hold the $\boxed{\text{FUNC}}$ key, then press the $\boxed{\text{TONE}}$ key. Either the symbol "P", the symbol "PG" or no symbol will appear on the LCD display. "P" represents Personal and "PG" indicates Personal and Group together. No symbol indicates out of DSQ mode.
3. Each time the "PG" key is pressed the DSQ mode symbols will cycle as follow:

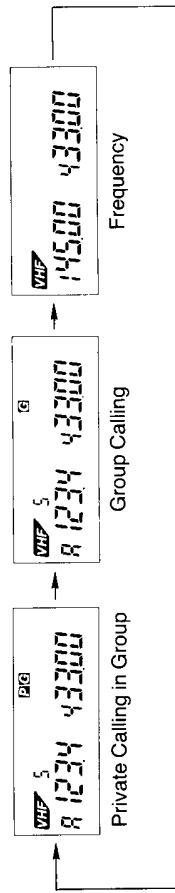

Setting A Private Call In A Group

Set "other's" single digit code.

Setting A Group Call

Set the three digit group code, then set own single digit code.

Storing The Settings

1. Select desired Main Band. The DSQ settings are now stored and the LCD display returns to the selected VHF or UHF frequency.
2. When the **PTT** is pressed the DSQ code is transmitted.

NOTE:

DSQ codes may be entered into both the VHF and the UHF bands. Once the DSQ function is set it is active on the Main Band.

Transmitting

Before Transmitting

1. Press and hold the **FUNC** key, then press the **PTT** key until "G" appears on the LCD display. The Group Calling Mode is active.
2. Enter a group code and own code.
3. Press the Main Band key. The DSQ code is now stored and the LCD display returns to the Main Band frequency.

Transmitting (Group Calling)

1. When the above setting is complete the DSQ code is transmitted automatically when the **PTT** is pressed. The transmitted DSQ code is shown here:

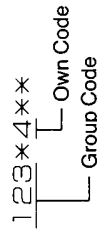

Transmitting (Private Calling In A Group)

1. Press and hold the **FUNC** key, then press the **PTT** key until the "P G" appears on the LCD display. Private calling in a group is now active.
2. Enter the "other's" code.
3. When the **PTT** is pressed the DSQ code is stored and the DSQ code is transmitted automatically. The transmitted DSQ code is shown here:

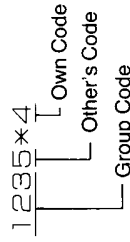

Receiving

To receive DSQ coded calls select either Group Calling, "G", or Private Calling In A Group, "P G".

Receiving (Group Call)

1. When the received DSQ code matches the Group Code "G" flashes on the LCD and a BEEP sounds to alert the listener to an incoming call.
2. When an incoming call is received the DSQ code is displayed on the LCD. The displayed code will be the Group code and "own" code. The "other's" code will also appear on the LCD.

Receiving (Private Call In A Group)

1. When an incoming DSQ coded call matches both the Group code and the "own" code "P G" will flash on the LCD and a BEEP will alert the listener to an incoming private call. The DSQ code will be displayed and the "other's" mode is active. The "other's" private code will be displayed.

Note:

If a received DSQ coded signal matches the DSQ code of the expanded DSQ (Function II) the mode will be DSQ II.

Transmitting the DSQ Code

When the **PTT** switch is pressed the selected DSQ code will be transmitted with the signal.

"Other's" Code Not Confirmed

When the "other's" private DSQ code is not confirmed an "E" will appear on the LCD display instead of an "G".

Releasing Alarm And Flashing Alert

Press any key to silence the alarm and stop the flashing alert.

5-10. DSQ FUNCTION II (Expanded)

In the expanded DSQ II mode three digit groups are used for all DSQ codes.

Pager, Group Calling

Calls all members of a specific group.

Pager, Private Calling

Calls a specific person.

Code Squelch

Used with a three digit code this function works the same as Tone Squelch.

DSQ 3 Digit Group Code

This code is common to all group members. It is also used for Code Squelch and is required for group calling.

DSQ 3 Digit Own Code

This is the user's private code. It is also used for Code Squelch and for private calling.

DSQ 3 Digit Others Code

This is the private calling code for a specific individual in the group. It is also used for Code Squelch.

Note:

DSQ II uses the same 16 numbers, letters and symbols as DSQ I (See 5-9).

Setting DSQ Codes

1. Select desired Main Band.
2. Press and hold the **FUNC** key, then press the **PTT** key. The DSQ code display mode is now active and a DSQ code will replace the Main Band frequency on the LCD. Do not release the **FUNC** key.
3. With the **FUNC** key still depressed each touch of the **DSQ SET** key will cycle the DSQ memory code from A through D as follows:

Memory Letter	Code
A Transmit Other's Code
B Transmit Group Code
C Own Code
D Monitor Other's Code

4. Select a memory then enter a DSQ code using the keypad.
5. Press desired Main Band key to store DSQ memory and code. The LCD display returns to frequency.

Selecting DSQ Mode

When a DSQ code has been entered the DSQ mode is selected by pressing the $\left[\begin{smallmatrix} \text{D.SQ} \\ \text{SET} \end{smallmatrix} \right]$ key repeatedly until the desired code symbol appears to the left of the Main Band frequency display.

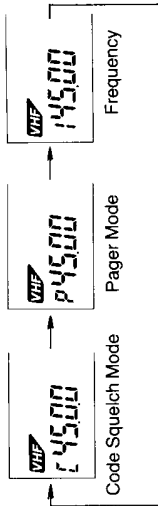

Note:

When the DSQ mode is set, if functions on the Main Band only. The selected settings remain the same whichever band is selected as the Main Band.

Operating Pager Before Transmit

- Press and hold the $\left[\begin{smallmatrix} \text{FUNC} \\ \text{D.SQ} \end{smallmatrix} \right]$ key, then press the $\left[\begin{smallmatrix} \text{D.SQ} \\ \text{SET} \end{smallmatrix} \right]$ key to select the DSQ Set mode.
- Enter the "other's" code to be transmitted, then enter the "group" code, then enter "own" code.
- Press desired Main Band key to store DSQ codes and return the LCD display to frequency.

Transmitting A Group Call

- Press and hold the $\left[\begin{smallmatrix} \text{FUNC} \\ \text{D.SQ} \end{smallmatrix} \right]$ key, then press the $\left[\begin{smallmatrix} \text{D.SQ} \\ \text{SET} \end{smallmatrix} \right]$ key to select the DSQ set mode. Do not release $\left[\begin{smallmatrix} \text{FUNC} \\ \text{D.SQ} \end{smallmatrix} \right]$ key.
- With the $\left[\begin{smallmatrix} \text{FUNC} \\ \text{D.SQ} \end{smallmatrix} \right]$ key still depressed press the $\left[\begin{smallmatrix} \text{D.SQ} \\ \text{SET} \end{smallmatrix} \right]$ to select Memory B (the Group calling mode).
- Press the Main Band key to store the DSQ mode and return the LCD display to frequency.
- When the $\left[\begin{smallmatrix} \text{PTT} \\ \text{D.SQ} \end{smallmatrix} \right]$ is pressed the DSQ code is transmitted automatically with the signal.



Receiving A Private Call

- Repeat Steps 1-3 above to activate the Pager mode.
- Repeat Step 4 above, this time selecting Memory B (own code).
- If the received DSQ coded signal matches the set DSQ "own" code "P" will flash, an alert BEEP will be emitted and the received "other's" code will be displayed.

Note:

If the received coded signal matches the "P G" pager code the "P G" page mode is selected automatically.

When "other's" code is not confirmed "E" will be displayed on the LCD instead of "P".

Press any key to stop the flashing LCD alarm and alert tone.

Code Squelch Operation

- Press and hold the $\left[\begin{smallmatrix} \text{FUNC} \\ \text{D.SQ} \end{smallmatrix} \right]$ key, then press the $\left[\begin{smallmatrix} \text{D.SQ} \\ \text{SET} \end{smallmatrix} \right]$ key to select the DSQ code setting mode.
- With the $\left[\begin{smallmatrix} \text{FUNC} \\ \text{D.SQ} \end{smallmatrix} \right]$ key still depressed press the $\left[\begin{smallmatrix} \text{D.SQ} \\ \text{SET} \end{smallmatrix} \right]$ key to select a DSQ Memory Channel. Any one of the four memories, A-D, may be used in the Code Squelch mode.
- Select a three digit Code Squelch code using the keypad.
- Press the $\left[\begin{smallmatrix} \text{PTT} \\ \text{D.SQ} \end{smallmatrix} \right]$ switch to return the LCD display to frequency.
- Press the $\left[\begin{smallmatrix} \text{D.SQ} \\ \text{SET} \end{smallmatrix} \right]$ key until "E" appears to the left of the frequency on the LCD display. Code Squelch mode is now active.
- When the $\left[\begin{smallmatrix} \text{PTT} \\ \text{D.SQ} \end{smallmatrix} \right]$ is pressed the Code Squelch code is transmitted automatically with the signal.
- If received Code Squelch signal matches the set Code Squelch code "E" will appear on the LCD, squelch will open and the incoming signal will be received.

Wild Card Function

The $\left[\begin{smallmatrix} \# \\ \text{D.SQ} \end{smallmatrix} \right]$ symbol is a wild card that may be substituted for any one of the numbers, letters or symbols used in DSQ codes. $\left[\begin{smallmatrix} \# \\ \text{D.SQ} \end{smallmatrix} \right]$ may also be used to represent all three code digits. $\left[\begin{smallmatrix} \# \\ \text{D.SQ} \end{smallmatrix} \right]$ may also replace the group code in group calling and the code squelch code in the Code Squelch mode.

For Example:

- Enter the group code "1 # 5".
- Select the Code Squelch mode.
- If the incoming coded call is any one of the following groupings the call will be received: "105 through 195", "1A5 through 1D5", "1*5" or "1#5".

Using The $\left[\begin{smallmatrix} \# \\ \text{D.SQ} \end{smallmatrix} \right]$ Symbol

- Press and hold the $\left[\begin{smallmatrix} \text{FUNC} \\ \text{D.SQ} \end{smallmatrix} \right]$ key, then press the $\left[\begin{smallmatrix} \text{D.SQ} \\ \text{SET} \end{smallmatrix} \right]$ to select the Group code. The Group code may be confirmed and the $\left[\begin{smallmatrix} \# \\ \text{D.SQ} \end{smallmatrix} \right]$ will card symbol will be replaced by a number, letter or symbol. The Group code is active and the radio can transmit or receive on the selected Group frequency.

Note:

The Wild Card function may also be used in DSQ Function 1. See 5-9.

5-11. AUTOMATIC DIALER

The DJ-560T/E offers one automatic dialer channel. The telephone number may be entered in either the VHF or the UHF frequency area. The stored telephone number is transmitted on whichever band is selected as the Main Band.

Entering A Telephone Number

- Press and hold the $\left[\begin{smallmatrix} \text{FUNC} \\ \text{D.SQ} \end{smallmatrix} \right]$ key, then press the $\left[\begin{smallmatrix} \text{D.SQ} \\ \text{SET} \end{smallmatrix} \right]$ key. The frequency display will be replaced by four dashes. The " " will flash indicating that the dialer memory is ready to accept the number to be stored.
- Up to sixteen numbers, letters and symbols may be entered, four at time in four groups. After each group of four is entered the second group will replace the first and so on.

- The entered number is stored by pressing the desired Main Band key or the **PTT** switch. The LCD display will return to frequency and the " " becomes steady indicating that the dialer memory contains a stored number.
- To change the stored number repeat Steps 1-3. The new number replaces the previously stored number.

Transmitting A Stored Telephone Number

- Verify that the " " appears on the LCD.
- Press and hold the **PTT** switch, then press the **FUNC** key. The stored telephone number will be transmitted.

Note:

If the repeater autopatch requires entry of an access code as part of the telephone number enter the code immediately ahead of the telephone number. The access code will be transmitted with the telephone number.

If the autopatch is accessed with a separate code before the telephone number is entered press the **PTT** switch, then enter the patch access code. When the dial tone is heard, press **PTT** switch then press the **FUNC** key to transmit the number.

Clearing The Automatic Dialer Memory

- To clear the automatic dialer memory press the **FUNC** key, then press the **OK** key. The automatic dialer memory is now accessed. Do not release the **FUNC** key.
- With the **FUNC** key still depressed press the **OK** key. The automatic dialer memory is now empty and the " " disappears from the LCD display.

5-12. AUTOMATIC BAND EXCHANGE (ABX)

When the Automatic Band Exchange function is active whichever band is receiving a signal becomes the Main Band. If both bands are quiet the first band to receive a signal becomes the Main Band.

- To activate the ABX function press the **ABX** key for more than one half second. If the **ABX** key is pressed for less than one half second the bands are exchanged but the function does not become automatic.
- If the Main Band is quiet and the sub-band becomes active the sub-band automatically becomes the Main Band.
- If the Main Band is active it remains the Main Band even if the sub-band becomes active.
- If the sub-band becomes active while the Main Band is receiving a signal the sub-band becomes the Main Band three seconds after the other band becomes quiet.
- The transmitter will function on whichever band is the Main Band when the **PTT** switch is pressed.
- To cancel the ABX function, press the **ABX** key again.

5-13. BEEP AND BELL

Selecting The BEEP ON/OFF And BELL Functions

- Press and hold the **FUNC** key, then press the **BEEP/BELL** key. Each time the **BEEP/BELL** key is pressed the display will cycle through the BEEP ON, BEEP OFF and BELL functions.
- Press the **BEEP/BELL** key until desired function appears.
- Press desired Main Band key or the **PTT** to store desired BEEP or BELL function and return to frequency display.

Note:

Throughout this manual reference is made to a BEEP being emitted when certain functions are activated. The BEEP will sound only if the BEEP function is ON.

Operating The Bell Function

The BELL function is a visual indicator that a signal is being received. It is useful when the Tone Squelch or Code Squelch functions are in use.

- Select the Main Band.
- Press and hold the **FUNC** key, then press the **BEEP/BELL** key until " " appears on the LCD display.
- The " " will appear on the LCD display.
- Press desired Main Band key or **PTT** to return to frequency.
- When a signal is received the " " will flash and an alert BEEP will sound.
- In the Tone Squelch or Code Squelch modes the " " will flash and a BEEP will sound when an incoming call matches the set Tone or Code Squelch codes.
- The BELL function may be set and activated on both bands at the same time. Perform Steps 1-4 on the Main Band then select the other band as the Main Band and repeat Steps 1-4. The BELL function is now active on both bands simultaneously.

5-14. MONO BAND

In the Mono Band mode the sub-band is completely disabled.

- Select desired Main Band.
- Press and hold the **FUNC** key, the press the **MONO** key. The sub-band frequency display will disappear and only the Main Band is active.
- In the MONO mode the disabled sub-band cannot receive a signal.
- To cancel the MONO mode and return to twin band operation press the **FUNC** key, then press the **MONO** key again.
- MONO may also be cancelled by pressing the sub-band selector key.

5-15 FREQUENCY LOCK (FL) AND KEY LOCK (KL)

When the Frequency Lock mode is selected frequencies of both bands are locked and cannot be altered. In the Key Lock mode most control and command keys are locked and do not work. These are useful features to prevent unauthorized functioning while the radio is in an unattended monitoring mode.

- Press and hold the **FUNC** key, then press the **FL** key.
- With the **FUNC** key still depressed, each time the **KL** key is pressed the LCD display will cycle through KL, FL ON and FL OFF.
- Select desired function. Display returns automatically to the frequency two seconds later.
- In the KL and FL ON modes all command and control keys are locked out with the exception of **PTT**, **MONO** and **PTT**.

5-16. PTT LOCK

In the PTT LOCK mode the **PTT** switch is disabled. Unintentional transmitting is prevented in this mode.

- Press and hold the **FUNC** key, then press the **PTT** key. The "PTT.L" symbol appears on the LCD display and the transmit mode is disabled.
- To cancel PTT LOCK press and hold the **FUNC** key, then press the **PTT** key again. The "PTT.L" symbol disappears from the LCD display and the transmit function is restored.

5-17. LAMP

Press the **LAMP** key to illuminate the LCD display. The lamp goes out automatically after five seconds. LAMP may also be cancelled by pressing the **LAMP** key again. To defeat the automatic OFF feature press and hold the **FUNC** key, then press the **LAMP** key. The LAMP will remain ON until it is turned off by pressing **LAMP**.

5-18. AUTOMATIC BATTERY SAVE (BS)

This very useful feature reduces unnecessary battery drain by alternating between listening and the Battery Save mode. If there is no operation for a period of about three seconds the BS mode will repeat the following cycle continuously:

1. Listen for a signal for about 400 mS.
2. Battery Save for about 800 mS.

BS OPERATION

1. To activate the "bS ON" function press and hold the **FUNC** key then press the **BS** key until "bS ON" appears on the LCD. The Battery Save function is now active.
2. The display returns to frequency after two seconds.
3. To cancel the "bS ON" function press and hold the **FUNC** key, then press the **BS** key until "bS OFF" appears on the display.

5-19. AUTOMATIC POWER OFF (APO)

The APO function prevents inadvertent waste of battery power when the radio is left ON unintentionally.

1. To activate APO press and hold the **FUNC** key, then press the **APO** key.
2. Select "APO ON" on the LCD display. The APO function is now active. After about thirty minutes of no activity, a BEEP is emitted and the LCD display disappears. Battery power is now OFF.
3. To turn radio ON again, turn OFF the power switch then turn on the power again. The APO function is still active and the radio will turn OFF again after about thirty minutes of no activity.
4. To cancel APO press the **FUNC** key, then press the **APO** key again until "APO OFF" appears on the LCD display.

5-20. SQUELCH (OFF)

Press and hold the **SQ** key to override squelch on the Main Band. In this mode weak signals below the squelch threshold may be heard.

5-21. RESET

1. With the power off, press and hold the **FUNC** key, then turn on the power. The radio will reset to initial factory settings as follows:

Reset Chart

	VHF	UHF
VFO frequency	145.00 MHz	445.00 MHz (DJ-560T) 433.00 MHz (DJ-560E)
Memory channel	1	1
Channel step	5 kHz (DJ-560T) 12.5 kHz (DJ-560E)	5 kHz (DJ-560T) 12.5 kHz (DJ-560E)
Shift direction	None	None
Offset frequency	0.6 MHz	5 MHz (DJ-560T) 7.6 MHz (DJ-560E)
Tone setting	None	None
Tone frequency	88.5 Hz	88.5 MHz
DSQ setting	None	None
Call frequency	145.00 MHz	445.00 MHz (DJ-560T) 433.00 MHz (DJ-560E)
40 memory channels	Empty	Empty

5-22. VHF-UHF EXTERNAL SPEAKER JACK

(See 3-2, #16)

The DJ-560T/E features an external speaker jack with separate terminals for VHF and UHF. When a stereo headset is used each band is heard separately, one in each earphone.

Separate external speakers may be plugged into this jack using a mini dual stereo adapter plug. VHF is heard on the Left channel and UHF is heard on the Right channel.

CAUTION!

Inserting a standard mono plug into this jack will short circuit the UHF channel. Use stereo plugs only.

NOTE:

Whenever this external jack is in use the audio jack on the top of the radio is disabled.