

VHF FM HANDHELD TRANSCEIVER

DJ-F1T/E/H

DJ-S1T/E DJ-F1TD/ED

DRY CELL PACK UNIT BATTERIES NOT INCLUDED

UHF FM HANDHELD TRANSCEIVER

DJ-F4T/E/H

DJ-S4T/E DJ-F4TD/ED

DRY CELL PACK UNIT BATTERIES NOT INCLUDED

INSTRUCTION MANUAL

Caution: Thai version does not have the connector for DTMF unit and DTMF function is not available.

ALINCO ELECTRONICS INC.

438 Amapola Avenue, Unit 130, Torrance, CA 90501, U.S.A.
Phone: (310) 618-8616

1-1-1 Mishimae, Takatsuki city, Osaka 569, Japan

TABLE OF CONTENTS

INTRODUCTION	1
1. ACCESSORIES	1
1-1 STANDARD ACCESSORIES.....	1
1-2 OPTIONAL ACCESSORIES.....	1
1-3 SETTING DRY CELL BATTERIES.....	2
1-4 CHARGING Ni-Cd BATTERY PACK.....	2
1-5 ATTACHING BATTERY PACK AND DRY CELL BATTERY CASE TO MAIN UNIT.....	3
1-6 REMOVING BATTERY PACK AND DRY CELL BATTERY CASE FROM MAIN UNIT.....	3
2. SPECIFICATIONS	4
3. CONTROL FUNCTIONS	5
3-1 TOP VIEW.....	5
3-2 FRONT, BACK, AND SIDE VIEW.....	6
3-3 LCD PANEL.....	8
3-4 FUNCTIONS OF KEYS.....	10
4. OPERATION: I	12
4-1 RECEIVING.....	12
4-2 TRANSMITTING.....	12
4-3 OPERATIONAL MODES.....	13
4-4 FREQUENCY SELECTION.....	14
4-5 CALL CHANNEL.....	14
4-6 MEMORY.....	15
4-7 SCANNING.....	17
4-8 CHANNEL STEP.....	20
4-9 SHIFT DIRECTION AND OFFSET FREQUENCY.....	21
4-10 SPLIT (odd offset) OPERATION.....	22
4-11 TONE ENCODER AND TONE SQUELCH.....	24
4-12 MEMORY SHIFT FUNCTION.....	26
4-13 PROGRAMMABLE VFO RANGE FUNCTION.....	28
4-14 DIAL CONTROL REVERSE FUNCTION.....	29
4-15 FREQUENCY LOCK (FL) AND PTT LOCK (PL).....	29
4-16 ONE TOUCH SQUELCH DE-ACTIVATION FUNCTION.....	30
4-17 LAMP.....	30
4-18 AUTOMATIC BATTERY SAVE (BS).....	30
4-19 ON/OFF OF BEEPER.....	30
4-20 RESET.....	31
4-21 TONE BURST (E VERSION ONLY).....	31

In this section, the operations using DTMF keys (Standard for F Series, Optional for S Series with ESK-1(B), [DTMF keypad]) are explained. For S Series, Optional DTMF Unit, EJ-10U is also necessary for the functions of 5-10 DSQ (Paging), 5-11 Digital Signal Message and 5-12 Automatic Dialer.

5. OPERATION: II	32
5-1 FREQUENCY SELECTION.....	32
5-2 RETRIEVING OF MEMORY CHANNEL.....	33
5-3 SCANNING.....	33
5-4 PRIORITY WATCH FUNCTION.....	35
5-5 SETTING OFFSET FREQUENCY.....	37
5-6 SETTING OF SHIFT DIRECTION AND SPLIT.....	38
5-7 REVERSE FUNCTION.....	39
5-8 SETTING OF TONE FREQUENCY.....	39
5-9 TONE ENCODER AND TONE SQUELCH.....	40
5-10 DSQ FUNCTION: PAGING.....	41
5-11 DIGITAL SIGNAL MESSAGE FUNCTION.....	46
5-12 AUTOMATIC DIALER FUNCTION.....	47
5-13 AUTOMATIC POWER OFF (APO) FUNCTION.....	49
5-14 MEMORY SHIFT FUNCTION.....	50
5-15 DIAL CONTROL REVERSE FUNCTION.....	50
5-16 ON/OFF OF BEEPER.....	50
6. REMOTE CONTROL MICROPHONE	51
7. ATTACHING OPTIONAL ACCESSORIES	52
7-1 DTMF UNIT EJ-10U AND TONE SQUELCH UNIT EJ-12U.....	52
7-2 DTMF KEY PAD ESK-1(B).....	53

INTRODUCTION

Thank you for purchasing the "ALINCO" transceiver. ALINCO radios and other products are ranked as some of the finest in the world. Your transceiver has been manufactured and tested very carefully at the factory and will give you satisfactory operation for many years. We are confident that you will be very satisfied with your choice of this fine ALINCO radio.

1. ACCESSORIES

1-1 STANDARD ACCESSORIES

Carefully unpack your transceiver and you will find the standard accessories included:

- ① Dry Cell Battery Case EDH-5 (DJ-S1T/E, S4T/E, F1TD/ED, F4TD/ED)
- ② Ni-Cd Battery Pack (7.2V 700mAh) EBP-16N (DJ-F1T/E, F4T/E Only)
- ③ Ni-Cd Battery Pack (12V 600mAh) EBP-18N (DJ-F1T/H Only)
- ④ AC Wall Charger EDC-24 (120V, DJ-F1T, F4T Only)
- ⑤ VHF Antenna EA-17 (DJ-F1T/E, S1T/E, F1TD/ED Only)
- ⑥ UHF Antenna EA-18 (DJ-F4T/E, S4T/E, F4TD/ED Only)
- ⑦ Belt Clip (with Screws) EBC-3
- ⑧ Hand Strap

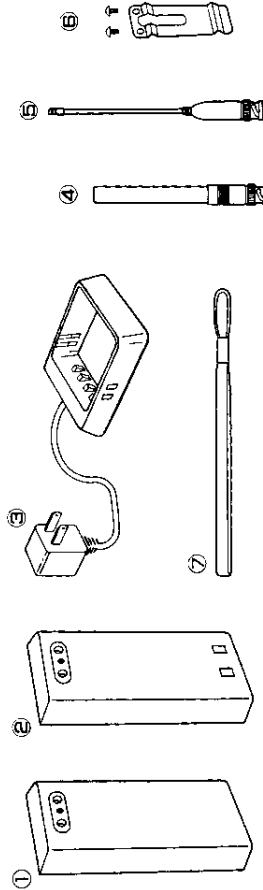

1-2 OPTIONAL ACCESSORIES

- Ni-Cd Battery Pack (7.2V 400mAh, Thin Type) EBP-14N
- Ni-Cd Battery Pack (12V 600mAh) EBP-18N
- AC/DC Quick Charger (1 Hour Type) EDC-34 (110V)/EDC-35 (220V)
- Mobile DC Power Cable/Charger w/Noise Filter EDC-36
- Mobile DC Power Cable/Charger EDC-43
- Earphone EME-6
- Earphone/Microphone w/PTT EME-4
- Earphone/Microphone w/PTT/VOX EME-11
- Headset w/PTT/VOX EME-10 (K)
- Remote Control Speaker/Microphone EMS-8
- Speaker/Microphone EMS-2Z
- Shoulder Belt w/Soft Case EBC-5
- Cable for Power Supply at 138V ESC-37
- Soft Case ESC-15
- DTMF Encoder/Decode Unit EJ-10U (Built-in for DJ-F1T/E, F4T/E)
- Tone Squelch Unit EJ-12U
- DTMF Key Pad ESK-1 (B) (Built-in for DJ-F1T/E, F4T/E)

1-3 SETTING DRY CELL BATTERIES TO CASE

- ① Remove the cover of the dry cell battery case
- ② Set 6 AA Dry Cell Batteries in accordance with the directions indicated in the case
- ③ Attach the cover to the case

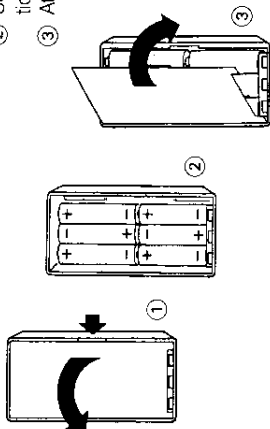

1-4 CHARGING Ni-Cd BATTERY PACK

Installation

Slide the ribs on both side of the battery pack into the grooves of the charger, then insert it until it is put in the corner holes.

Note:

1. The required charging time for fully discharged EBP-16N with EDC-24/EDC-25 is about 15 hours.
2. Any of EBP-16N, Optional EBP-14N, and EBP-18N can be charged with EDC-24/EDC-25 and can be quick charged with Optional EDC-34/EDC-35.

Cautions

1. The battery pack is not charged when shipped. It must be charged before using.
2. Although the battery pack can be charged while it is attached to the main unit, turn off the power of the transceiver while charging. Operating the transceiver while charging will cause a damage.
3. Never charge the battery packs of other makes with the charger and never charge the battery pack with the charger of other makes.
4. Charging should be conducted in the temperature range of 0°C to 45°C, as incomplete charging or deterioration of battery performance may occur if charged outside this range.
5. Do not modify, dismantle, incinerate or immerse the battery pack and the charger in water as this may be dangerous. Be careful not to drop the battery pack and the charger or subject them to any severe shocks.
6. Never put a metal object or a wire into the battery pack and the charger and never short-circuit their terminals, as they may cause damage to the equipment or lead to heating of the battery which may cause burns.

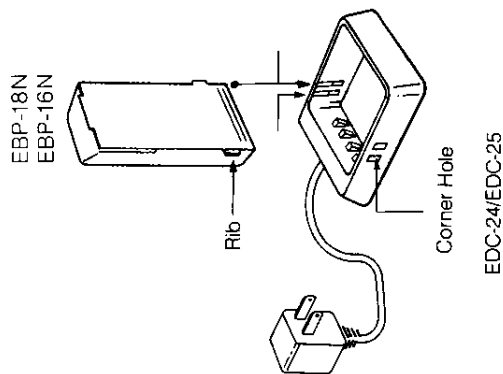

2. SPECIFICATIONS

■ GENERAL

Frequency Coverage

F1T, S1T & F1TD: TX: 144,000-147,995 MHz
 RX: 138,000-173,995 MHz
 (AM Mode 118 — 136 MHz after Modification)
 F1E, S1E & F1ED: TX: 144,000-145,995 MHz
 RX: 144,000-145,995 MHz

F4T, S4T & F4TD: TX: 440,000-449,995 MHz
 RX: 410,000-470,000 MHz
 F4E, S4E & F4ED: TX: 430,000-440,000 MHz
 RX: 430,000-440,000 MHz

Memory Channel

40 Channels + 1 Call Channel

5, 10, 12.5, 15, 20, and 25 kHz

F1T/E & S1T/E: 600 kHz

F4T & S4T: 5 MHz

F4E & S4E: 7.6 MHz

(Resettable by 5 kHz [Minimum] between 0 and 15,995 MHz)

F3E (FM)

150 Ω nominal

rated 9V

2 k Ω nominal

8 Ω nominal

110 (H) x 53 (W) x 37 (D) mm (4.3 x 2.1 x 1.5 inch)

(with Battery Pack EBP-16N or Dry Cell Battery Case)

(without Projections)

F1T/E & F4T/E: Approx. 375 g (13.2 oz) with Battery Pack EBP-16N

F1T/H & S4T/E: Approx. 415 g (14.6 oz) with Battery Pack EBP-18N

S1T/E & S4T/E: Approx. 370 g (13 oz) with Dry Cell Battery Case

Negative

Weight

Ground

■ TRANSMITTER

Output Power

with Battery Pack EBP-16N

Hi	Mid	Low
2 W (F1T/E & S1T/E)	1 W	0.1 W
1.5 W (F4T/E & S4T/E)		

with Battery Pack EBP-18N or at 13V

Hi	Mid	Low
5 W	1 W	0.1 W

with Dry Cell Battery Pack at 9V

Hi	Mid	Low
2.5 W (F1T/E & S1T/E)	1 W	0.1 W
2 W (F4T/E & S4T/E)		

Variable Reactance Frequency Modulation

± 5 kHz

Less than 60 dB below carrier

Built-in Electret Condenser

■ RECEIVER

Receiving System

Double-conversion superheterodyne

Sensitivity 12 dB SINAD less than -15 dB μ

Intermediate Frequencies 1st 230.5 MHz

2nd 455 kHz

- Unnecessarily prolonged charging (overcharging) may result in deterioration of battery performance.
- The battery pack should be stored in a dry place with a temperature range of -20°C to $+45^{\circ}\text{C}$. Temperatures outside this range or extremely high levels of humidity may lead to leaking of the battery liquid or resting of the metal components of the batteries.
- Never charge the battery pack under the direct rays of the sun, near heater, or in a dusty or humid environment.
- Normally the battery pack can be charged up to 300 times. However, the battery pack can be considered to be exhausted if the period of use drops off markedly despite being charged for the aforementioned time. When this happens, a new pack should be used.

1-5 ATTACHING BATTERY PACK AND DRY CELL BATTERY CASE TO MAIN UNIT

- Unlock the Battery Lock Button Hook as indicated in fig. a-1.
- Put the rib of the battery pack or the case into the grooves of the main unit and attach the pack or case as indicated by the arrow.
- Lock the Battery Lock Button Hook as indicated in fig. a-2.

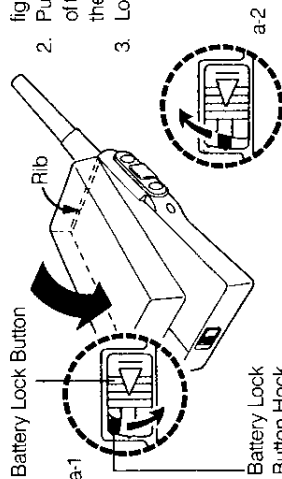

1-6 REMOVING BATTERY PACK AND DRY CELL BATTERY CASE FROM MAIN UNIT

- Unlock the Battery Lock Button Hook as indicated in the above fig. a-1.
- Slide the Battery Lock Button as indicated in fig. a-4 and hold, then remove the pack or the case as indicated by the arrow in fig. a-3.

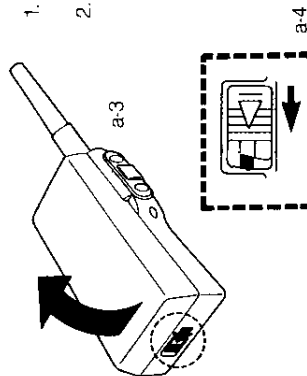

3. CONTROL FUNCTIONS

3-1 TOP VIEW

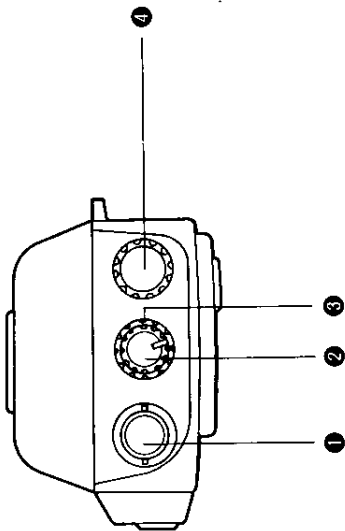

- 1 BNC Antenna Connector** Attach 50 Ohms antenna to this connector.
- 2 ON/OFF Volume Control** in the fully counterclockwise position, Power is OFF. Rotate clockwise to turn on Power and increase audio.
- 3 Squelch Control** When no signal is present in the receive mode, adjust this squelch control clockwise until back ground noise just disappears.
- 4 Dial** This dial is used to change frequency by channel step in VFO Memory mode. It can also be used to change memory number in Memory mode. When the radio is in Dial Control Reversed Mode, the dial is used to change frequency in Memory mode (Flashing "M" mode) and memory number in VFO mode.

3-2 FRONT, BACK, AND SIDE VIEW

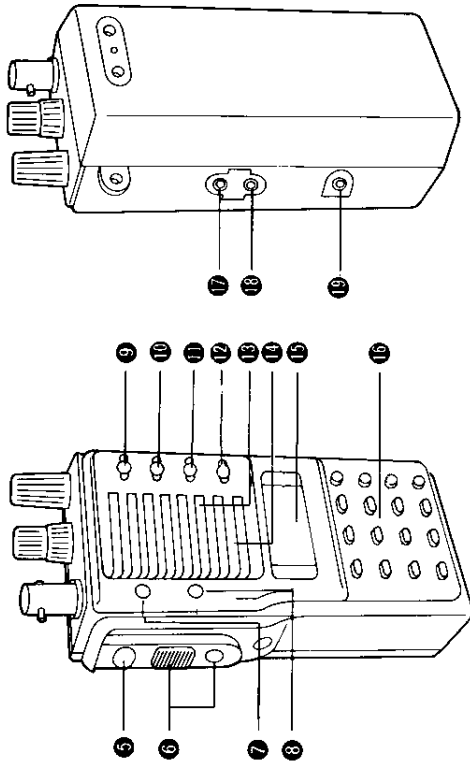

5 Function [F] Key

This key is used to access all secondary functions (printed in blue).

Press the [F] key and hold, then press the desired command key. Also this key is used to reset the unit. (See 4-20 Reset)

6 PTT (Press to Talk)

Press this button for transmission and speak into the microphone.

Note: On the DJ-F1E, F4E, S1E, and S4E, the lower button transmits a Tone Burst; the upper button is the PTT (See 4-21 Tone Burst).
On the DJ-F1T, F4T, S1T, S4T, either button activates PTT.

7 LAMP Key

Press this key; The LCD read out will be lit for 5 seconds. Press and hold the [LAMP] key and press the [MONI] key. The LCD read out will be lit until the [MONI] key is pressed again.

8 MONI, BS Key

1. Press this key to disengage squelch. Release the key to reengage squelch.

2. Press and hold the [MONI] key then press the [BAT] key for Battery Save function (See 4-18 Automatic Battery Save)

9 CALL, SET Key

Press this key to put the radio in the CALL Channel mode. "CALL" will appear on the LCD. Press the key again and the unit will return to VFO or Memory mode. To cancel the CALL mode, press the [CALL] key or the [MONI] key. Press and hold the [CALL] key and press the [MONI] key to put the unit in SET MODE. (See 4-3 (3) Set Modes).

10 V/M, MW Key

Press the **V/M** key. **V** and **M** will appear alternately on the LCD. **V** indicates that the unit is in the VFO mode and **M** indicates that the unit is in the memory mode. Press and hold the **F** key then press the **V/M** key to write a frequency and other data into the Memory Channel.

11 SCAN, STEP Key

Press this key to start SCAN function. There are two basic functions (1) Memory Scan, and (2) VFO Scan. VFO Scan includes BAND & PROGRAM scanning capabilities. Press and hold the **F** key then press the **SCAN** key (This function will work in any mode: Memory, VFO or CALL, it will not work in any scan mode) to select a Channel step.

12 PO, FL/PL (Frequency Lock/PTT Lock) Key

This key is to change transmission power. There are three steps of transmission power (High/Mid/Low). Press and hold the **F** key and the **PO** key. The **MON** will appear on the LCD. In this function the PTT, the **MON** and the **AVT** keys are acceptable. No other keys are acceptable. Press and hold the **F** key and press the **PO** key again. Then the **PL** will appear on the LCD. The PTT key will not be accepted. All keys are acceptable to operate except the PTT. To release this function, take the same procedures as above.

13 Speaker

14 Microphone

An electret condenser microphone is built-in. Speak into the microphone at a distance of approx. "5" when transmitting.

15 LCD

16 Key front touch pad (Standard for DJ-FIT/E and F4T/E, Optional for DJ-S1T/E and S4T/E).

17 Speaker Jack

This jack is for an External Speaker.

18 MIC Jack

This jack is for an extension microphone. ALINCO's optional accessories (EME-4, EME-11, EMS-2Z or EMS-8) are recommended.

19 DC IN Jack

This jack is for accessing the outside 13.8 V power source. ALINCO's optional accessories (EDC-36, EDC-37 or EDC-43) are recommended.

3-3 LCD PANEL

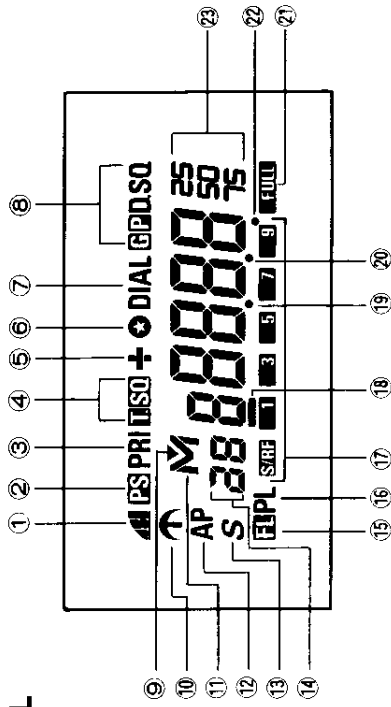

1 RF Power Indicator

Power level is indicated by 3 bars on the LCD panel.

2 PS (Program Scan)

The **PS** will appear on the LCD when the program scanning is activated.

3 PRI (Priority)

The **PRI** will appear on the LCD when the Priority function is activated. (Optional for DJ-S1T/E, S4T/E)

4 T, SQ

The **T** will appear when the unit is in Tone Encoder (Optional for E version) setting mode. The **SQ** will appear when the unit is in Tone Squelch (Optional for all models) setting mode.

5 "+/-" or "-"

"+" or "-" appears to indicate shift direction when transmitting at an offset frequency.

6 " * " (Transmit Shift)

Lights when split function is active.

7 " * " (Split indicator)

8 DIAL

Press and hold the **F** key then press the **DIAL** key. **DIAL** will flash on the LCD without the frequency. The unit can store up to 16 digits (numbers) or characters (letters, including " * " and " # ") (Optional Function for S Series).

9 DSQ (DTMF Squelch)

Press the **DSQ** key. **DSQ** will appear on the LCD. (See 5-10 DSQ function) (Optional Function for S Series).

MEMORY Skip

Press and hold the **F** key, then press the **MEM** key. " * " will appear above the **M** (Memory) during memory scan. The memory number with will be skipped (Optional function for S Series).



⑩ **Timed Scan Indicator**
()

When it is on, the Timed Scan is activated. When it is off, the Busy Scan will be activated.

⑪ **V/M (VFO/Memory)**

Press the  key. V and M will appear alternately on the LCD. V indicates that the unit is in the VFO mode and M indicates that the unit is in the memory mode. Flashing M indicates that a frequency is not stored in the memory number yet.

⑫ **AP (Automatic Power Off) Indicators**

Press and hold the  key then press the  key. AP will appear on the LCD. The unit will automatically shut off its power after pre-programmed time (See 5-13 AP function) (Optional function for S Series).

⑬ **S (Battery Save)**

The " **S** " will appear when Battery Save function is activated.

⑭ **Memory Number**

This unit has 40 memory capacity (0 through 39), and one Call channel. When the Call channel is activated, memory channel number will be replaced by " **C** ".

⑮ **FL (Frequency Lock)**

The "  " will appear when the Frequency Lock function is activated.

⑯ **PL (PTT Lock)**

The " **PL** " will appear when the PTT Lock function is activated.

⑰ **S/RF (Signal/Radio Frequency)**

Indicates signal strength during receiving, and the RF level during transmission.

⑱ **" - " (Digital Signal Message)**

The " **-** " symbol will appear when Digital Signal Messages are stored.

⑲ **Frequency Decimal Point**

When receive, transmit or offset frequency is displayed on the LCD the decimal point divides MHz and kHz. The decimal point will flash when the unit is in the SCAN mode.

⑳ **Tone Frequency Decimal Point**

When Tone frequencies are displayed the decimal point divides Hz and 0.1 Hz. When Channel Steps are displayed the decimal point divides kHz and 0.1 kHz.

㉑ **Full**

This symbol will appear whenever either received signal or transmitter power output are at their maximum.

㉒ **" . " (Unlock Dot)**



When a display/frequency is unlocked, this dot will be displayed on the LCD.

㉓ **Frequency**



Receive and transmit frequencies, offset and tone frequencies, channel steps, DSQ codes and dialer memory numbers are displayed in this area depending on the selected mode.

3-4 FUNCTIONS OF KEYS

1. Standard Functions

Keys	Without Pressing the  key	With Pressing the  key
ON/OFF Volume Control	ON/OFF of the Power	Reset Function
PTT	Upper	Transmitting
	Lower	<ul style="list-style-type: none"> • Transmitting (DJ,F,T, F4T, S1T, S4T) • Transmitting 1,750 Hz Tone (DJ,F,E, F4E, S1E, S4E)
Dial	<ul style="list-style-type: none"> • UP/DOWN of Frequency by Channel Step • Selection of Memory Channel 	<ul style="list-style-type: none"> • Automatic Dialer Function (DJ,F,T, F4T, S1T, S4T) • Transmitting 1,750 Hz Tone (DJ,F,E, F4E, S1E, S4E) • UP/DOWN of Frequency by 1 MHz
LAMP	ON/Automatic OFF of Lamp	ON/OFF of Lamp
MONI	BS	One Touch Squelch Deactivation
CALL	SET	Retrieving of CALL Frequency
V/M	MW	<ul style="list-style-type: none"> • Selection of VFO Frequency and Memory Frequency • Writing VFO Frequency into Memory Channel • Lock Function of Memory and CALL Frequency
SCAN	STEP	Memory Scan and Program Scan Function
PO	FL/PL	Selection of Output Power
		Selection of Channel Step
		ON/OFF of Frequency Lock Function and PTT Lock Function

2. Functions in SET MODE (After pressing +)

Keys	Without Pressing the  key	With Pressing the  key
LAMP	ON/OFF of Beeper	Setting of Programmable VFO Range
MONI	BS	Selection of Busy Scan and Timed Scan
CALL	SET	OFF of SET MODE
V/M	MW	OFF of SET MODE
SCAN	STEP	Setting of Shift direction, Split frequency, and Offset Frequency
PO	FL/PL	Setting of Tone Encoder (Optional for E version) and Tone Squelch (Optional) Functions
Optional for S Series	1	Frequency Programming from 1 MHz
	2	Selection of Interval between Pressing PTT and Transmitting of DTMF Code
	3	Transmitting of DTMF Code  when PTT is released

4. OPERATION I

4-1 RECEIVING

1. Turn on Power with the volume control.
 2. Adjust the volume control to desired level.
 3. Adjust the **SOL** control until white noise is off.
 4. Select desired frequency (See 4-4 Frequency Selection).
- When a signal is received, the " **SIG** " signal level bar will appear, and the voice will be heard.

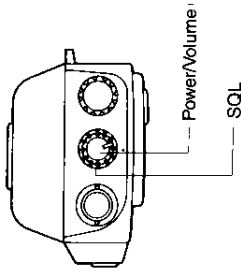

4-2 TRANSMITTING

(1) Transmitting Procedure

1. Select the desired frequency (See 4-4 Frequency Selection).
2. Press the PTT key to set a transmitting mode. " **SIG** " will appear on the LCD.
3. Holding the PTT key, talk to the microphone. (Approx. 5" distance)
4. Release the PTT key to resume a receiving mode.

Note: If the PTT key is pressed outside the TX frequency range, " **OFF** " will appear on the LCD and you can not transmit.

(2) Transmitter Power Output Selection

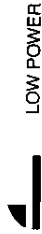

LOW POWER

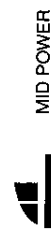

MID POWER

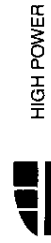

HIGH POWER

Note: If the temperature of the unit goes up, the output power will be lower to protect the unit. (F47/E)

3. DTMF Keys (Optional for S Series)

Keys	Without Pressing the F key	With Pressing the F key
1 SHIFT	Entering of 1	Setting of Shift direction and Split
2 OFF SET	Entering of 2	Setting of Offset frequency
3 REV	Entering of 3	Reverse Function
4 TONE	Entering of 4	Setting of Tone frequency
5 SKIP	Entering of 5	ON/OFF of Skip function in Memory Scan
6 T. SQ	Entering of 6	Setting of Tone Encoder/Tone Squelch
7 BEEP	Entering of 7	ON/OFF of Beeper
8 TMS	Entering of 8	Selection of Busy Scan and Timed Scan
9 APO	Entering of 9	ON/OFF of Automatic Power Off
0 DCHG	Entering of 0	Dial Control Reverse Function
▲ #	<ul style="list-style-type: none"> • UP of Frequency by Channel Step (SCAN Start) • UP of Memory Channel No. • Entering of # (DTMF Code) 	<ul style="list-style-type: none"> • UP of Frequency by 100 kHz
▼ *	<ul style="list-style-type: none"> • DOWN of Frequency by Channel Step (SCAN Start) • DOWN of Memory Channel No. • Entering of * (DTMF Code) 	<ul style="list-style-type: none"> • DOWN of Frequency by 100 kHz
PRI A	<ul style="list-style-type: none"> • Priority Function • Entering of A (DTMF Code) 	<ul style="list-style-type: none"> • Setting of Dial No.
B	<ul style="list-style-type: none"> • Entering of B (DTMF Code) 	<ul style="list-style-type: none"> • Setting of DSQ Code
CLR C	<ul style="list-style-type: none"> • Returning to the former Frequency • Entering of C (DTMF Code) 	<ul style="list-style-type: none"> • Cancellation of Code in Automatic Dialer Function • Memory Shift Function
G P D DSO MESS	<ul style="list-style-type: none"> • Setting of DSQ Mode • Entering of D (DTMF Code) 	<ul style="list-style-type: none"> • Display of Digital Signal Message

4-3 OPERATIONAL MODES

(1) Operational Modes

1. VFO Mode

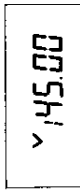

2. Memory Mode

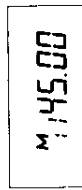

3. Call Mode

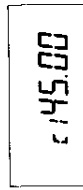

4. Steady Mode

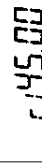
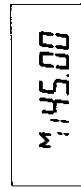

5. Flashing Mode

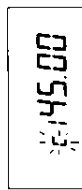

(2) Selection of Operational Modes

Operating frequencies, key settings, and functions are selected, and Band Scan, Program Scan and VFO Priority are activated in the VFO mode.

In the Memory mode, memory channels are retrieved. The transceiver has 40 memories (0 through 39). There are two types of mode: steady "M" on the LCD, and flashing "M" on the LCD. Memory Scan and Memory Priority can also be activated in this mode. Band Scan can be activated in the flashing "M" mode.

The Call Channels can be activated in this mode. There are two types of mode: steady "C" on the LCD, and flashing "C" on the LCD. You can activate the Call Priority in this mode. You can also activate the Band Scan in the flashing "C" mode.

It indicates that the frequency shown on the LCD has been written into the Memory Channel and the frequency is locked. Holding the [F] key, press the "M" key to set the flashing mode.

In the flashing light mode, the frequency in the Memory Channel can be changed. Band Scan can be selected in the flashing mode as in the VFO mode. Holding the [F] key, press the "M" key to write the changed frequency into memory. The flashing mode will be shifted to the steady mode.

1. Press the "M" key in VFO mode to get Memory mode.
2. Press the "M" key either in VFO mode or in Memory mode to get Call mode.
3. Press the "M" key to resume VFO mode or Memory mode.
4. Press the "M" key to resume VFO mode or Memory mode.
5. Press the "M" key in Memory mode to get VFO mode.

(3) Set Modes

1. The third function (Without pressing the [F] key) and the fourth function (With pressing the [F] key) of each key can be activated in this mode. Those functions are not printed on the keys (See 3-4-2. Function in Set Mode).
2. Holding the [F] key, press the "M" key. A beep sound will be heard to indicate that the unit is in Set mode. The Set mode is released by the same process.

4-4 FREQUENCY SELECTION

Initial factory channel step settings are 5 kHz for T version and 12.5 kHz for E version.

Tuning Dial

Rotating the tuning dial clockwise increases the frequency one channel step for each click. Counterclockwise rotation decreases the frequency one channel step for each click. If the [F] key is pressed and held, frequency will increase or decrease by 1 MHz depending on direction of tuning dial rotation.

4-5 CALL CHANNEL

The transceiver has one Call Channel which is immediately accessible by pressing the "M" key. An often-used frequency of interest, such as a preferred local repeater, is usually programmed into the Call Channel.

The initial factory Call Channel settings are 145.000 MHz for FIT/E and S17/E, 445.000 MHz for F4T and S4T, and 433.000 MHz for F4E and S4E.

(1) Accessing the Call Channel

1. Press the "M" key. "C" will appear on the LCD and the Call Channel will be accessed.
2. Press the "M" key again or the "M" key to return to the previous frequency and mode.

(2) Changing the frequency in the Call Channel

1. Press the "M" key to retrieve the Call Channel.
2. Press and hold the [F] key, and press the "M" key. A beep sound will be heard and "C" starts flashing.
3. Enter a desired frequency.
4. Press and hold the [F] key, press the "M" key.
5. A beep sound will be heard again and "C" stops flashing.
6. The frequency is now stored in the Call Channel and the radio is now in the CALL mode.

MEMORY

has a total of 40 memories. The initial factory Memory Channel settings are 145.000 MHz for F4T and S4T, and 433.000 MHz for F4E and S4E, for all memory channels.

Setting the Memory

1. Press the M key to get Memory Mode. Flashing "M" or Steady "M" will be appeared.
2. The tuning dial may be used to select a Memory Channel number in the Memory Mode.

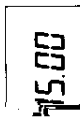

Setting a frequency Memory Channel

1. Press the M key to get Memory Mode.
2. Using the tuning dial, select a desired Memory Channel number.
3. Return to VFO Mode by pressing the M key.
4. Enter a desired frequency to be memorized into the VFO.
5. Press and hold the F key, then press the M key. A beep sound will be heard. The VFO frequency is now stored in the selected Memory Channel.
6. Set the radio in Memory Mode by pressing the M key. "M" will appear on the LCD and the frequency is stored.

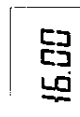
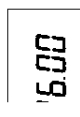
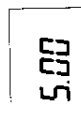

Setting a Memory Channel Frequency

1. Press the M key to put the radio in Memory Mode.
2. Select the Memory Channel number to be changed.
3. When "M" is flashing, skip to step 5.
4. Press and hold the F key, then press the M key. A beep sound will be heard, and "M" will start flashing.
5. Reverse the function of the dial (See 4-14 or 5-15 Dial Control Reverse Function).
6. Select a frequency to be memorized by rotating the dial.
7. Press and hold the F key, then press the M key. A beep sound will be heard and "M" will be steady. The VFO frequency is stored now.

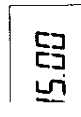
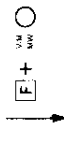
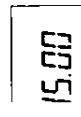

Reverse the function of the dial

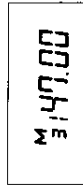
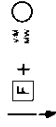
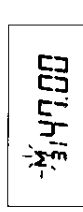

(4) Copying data in a Memory Channel to the other Memory Channel

1. Retrieve the Memory Channel whose data will be copied.
2. Press and hold the F key, then rotate the dial to select a desired Memory Number to be memorized the data. Only the Memory Number changes. Do not release the F key.
3. Holding the F key, then press the M key. A beep will be heard, and the procedure is completed.

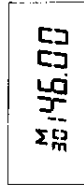
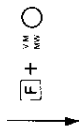
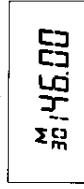
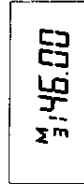

(5) What can be stored in Memory

1. Frequency
2. Shift (offset) direction; plus (+), minus (-) or split selection.
3. Subaudible tone encoder, tone squelch selection.
4. DSQ
5. Subaudible tone frequency
6. Shift (offset) frequency

All these functions can be stored in any Memory Channel. Desired functions are entered into memory along with frequency when a Memory Channel number has been selected and the radio is in VFO mode before the M key is pressed.

4-7 SCANNING

(1) Band Scan

Scans all frequency in a band

1. Press the SCAN STEP key. The frequency decimal point will flash indicating that scanning starts.
2. When a signal is received scanning will stop and remain on that frequency.
3. To resume scanning rotate the tuning dial clockwise to start upward scan, counterclockwise to start downward scan.
4. To stop scanning press either the SCAN STEP key, the V/M key, or the PTT key.

(2) Scans Memory

(2) Memory Scan

Scans Memory Channels
Memory Scan can be used in Memory Mode, and the Memory Channel will be skipped when "M" is flashing.

1. Press the V/M key to put the radio in Memory Mode.
2. Press the SCAN STEP key. The frequency decimal point will flash indicating that scanning starts.
3. When a signal is received scanning will stop and remain on that Memory Channel.
4. To resume scanning rotate the tuning dial clockwise to start upward memory scan, counterclockwise to start downward memory scan.
5. To stop Memory Scan, press either the SCAN STEP key, the V/M key, or the PTT key.

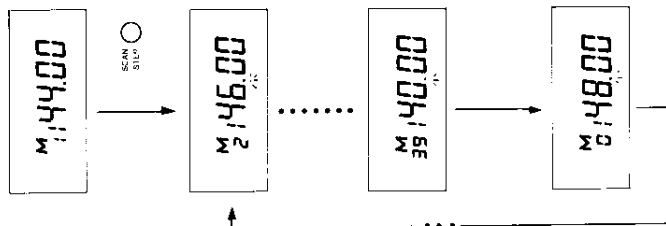

(3) Scanning Mode

Busy Scan

When a signal is received scanning stops and remains on the busy channel. Two seconds after the signal ceases scanning resumes.
(The initial factory scanning setting is the Busy Scan).

Timed Scan

Selecting a Scanning Mode

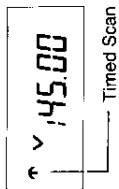

1. Press and hold the SCAN STEP key, then press the CALI SET key. A beep indicates that the unit is in the Set Mode.
2. Press the V/M key once. The " " will appear on the LCD. The unit will scan by Timed Scan.
3. Press the SCAN STEP key again. The " " will disappear. The unit will scan by Busy Scan.
4. Press the V/M key to release the Set mode. A beep indicates that the Set Mode is off.

(4) Program Scan

This function allows the unit to scan between two desired (H/L) frequencies in the VFO mode.

Setting Scanning Limits

Select Upper Limit

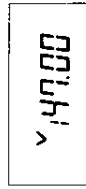

Memory Mode

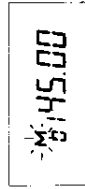

Select "H"

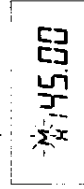

VFO Mode

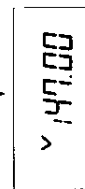

Memory "H"

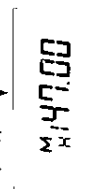

1. Select the desired upper frequency.
2. Press the V/M key to put the radio in Memory Mode.
3. Select the Memory Channel "H" by the dial. Rotate the downward from the Memory Channel 0, and the Memory channel "H" can be obtained.
4. Press the V/M key to resume the VFO mode.
5. Holding the SCAN STEP key, press the V/M key. Now the Upper Limit frequency is stored.
6. In the same manner enter the Lower Limit frequency into Memory Channel "L". To obtain the Memory Channel "L", turn the dial downward from the Memory Channel "H".

Program Scanning Operation

1. Press the **SCAN STEP** key in the VFO Mode.

2. "PS" will appear on the LCD, and a frequency decimal point starts flashing. This indicates that Program Scanning is activated.

3. Follow steps 2-4 in Band Scan operation.

Note: Only Band Scan will be activated when the same frequency is programmed into Memory Channel "H" and "L" or when the frequency in the Memory Channel "L" is higher.

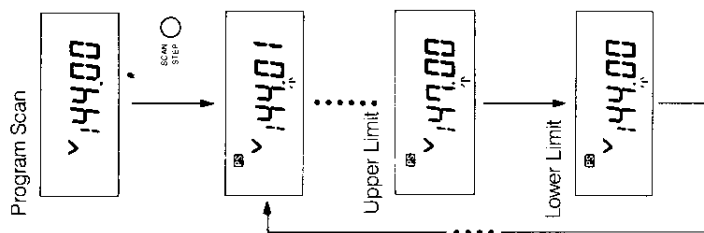

4-8 CHANNEL STEP (1) Setting Channel Step

1. Holding the **F** key, press the **SCAN STEP** key, the Channel Step will appear on the LCD.
2. Rotate the Dial clockwise or counterclockwise to change the Channel Step.
3. Press either the **MEM** key or the **PTT** key to release the mode. Or holding the **F** key, press the **SCAN STEP** key, the mode can also be released.
4. Rotating the tuning dial will now change the VFO frequency by the set Channel Step. VFO Band Scan frequency will also change by the set Channel Step.

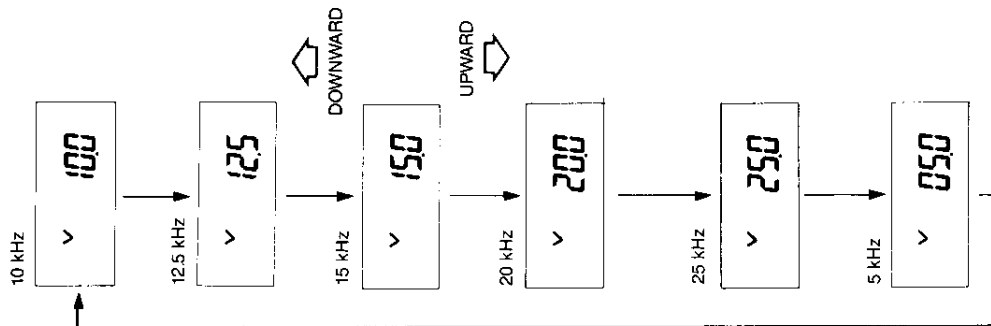

4-9 SHIFT DIRECTION AND OFFSET FREQUENCY

Almost all repeaters operate in the duplex mode. They receive on one frequency and transmit on another frequency. The difference between these frequencies is the offset, or shift frequency. The published repeater frequency is usually the repeater transmit frequency. This is the repeater frequency the repeater user selects on the LCD display.

The repeater user transmits on a frequency offset either above or below the repeater frequency.

Once the offset frequency and direction have been programmed into the transceiver they are automatically selected each time the PTT key is pressed.

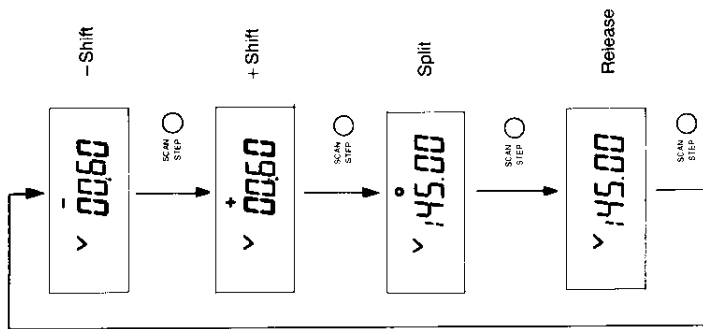

1. Holding the [E] key, press the CAL SET key. A beep will be heard to indicate that the unit is in the Set Mode.
2. Every time you press the SCAN STEP key, Shift Direction changes as the chart.
3. Press the VW key to release the Set Mode.

Entering an Offset (Shift) Frequency



1. Press the SCAN STEP key in the Set Mode. "+" or "-" will appear on the LCD.
An offset frequency will be indicated.
The initial factory offset frequency settings are 600 kHz for F1T/E and S1T/E, 5 MHz for F4T and S4T, and 7.6 MHz for F4E and S4E.
The Offset Frequency can be selected between 0 and 15.995 MHz.

2. Offset Frequency may be changed by rotating the Dial for small incremental changes by the channel step at a time.
3. For larger incremental frequency changes holding the [E] key, and rotate the Dial to increase or to decrease frequency 1 MHz each time.
4. To return to the displayed repeater frequency, press the VW key. A beep will be heard and the Set Mode will be released.

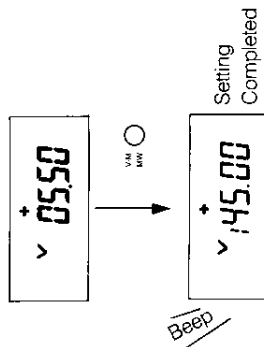

Selecting Offset (Shift) Direction

1. Holding the [E] key, then press the CAL SET key to put the radio in the Set Mode.
2. Press the SCAN STEP key until the desired offset symbol appears on the LCD.
3. A "+" symbol indicates an UP transmitter offset.
4. A "-" symbol indicates a DOWN transmitter offset.
5. When neither "+" nor a "-" symbol appears the transmitter is in the Simplex mode and will transmit on the receive frequency.
6. If "OFF" appears in place of the frequency during transmit, the selected offset frequency is out-of-band. The transmitter will not transmit. Reset the offset direction and the frequency.

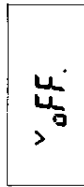

4-10 SPLIT (ODD OFFSET) OPERATION

This function allows you to operate the unit by independent frequencies of receiving and transmitting.

(1) Setting of Split Operation

1. Holding the [E] key, press the CAL SET key. A beep will be heard, and the unit is in the Set Mode.
2. Press the SCAN STEP key to get " " on the LCD.
3. Press the VW key to complete the procedure.

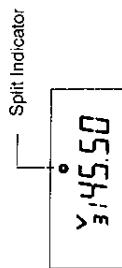

(2) Split Operation

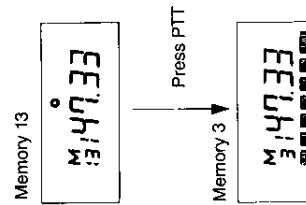
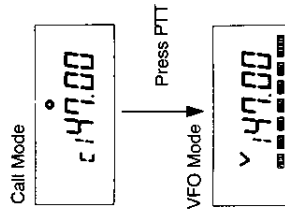
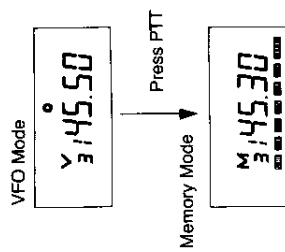

- in VFO Mode
 Receive Frequency: VFO Frequency
 Transmit Frequency: Memory Frequency

- in Call Mode
 Receive Frequency: Call Frequency
 Transmit Frequency: VFO or Memory Frequency

- in Memory Mode
 Memory Channel 0 — 9 A pair
 Memory Channel 10 — 19 A pair
 Memory Channel 20 — 29 A pair
 Memory Channel 30 — 39 A pair

Note: Prior to the Split Operation in the Memory Mode or the Call Mode, the pairs above need to be set.

4-11 TONE ENCODER AND TONE SQUELCH

- Both Tone Encoder and Tone Squelch are optional for E version. EJ-12U (Tone Squelch Unit) is necessary.
- Tone Squelch is optional for T version. Optional EJ-12U (Tone Squelch Unit) is necessary.

Setting Tone Encode and Tone Squelch

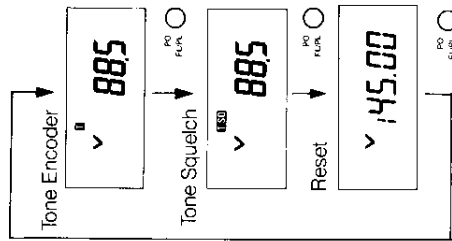

- Holding the **[E]** key, then press the **[CALL SET]** key. A beep will be heard, and the unit is in the Set Mode.
- Press the **[FREQ]** key. Tone settings will cycle each time the **[FREQ]** key is pressed as the chart (for T version, Tone Squelch Setting appears when EJ-12U is equipped.)
- Press the **[MEM]** key to release the Set Mode.

(1) Setting a Tone Frequency

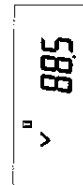

Access to an increasing number of repeaters is restricted by requiring that a sub-audible tone be transmitted with the input signal to open the repeater. A repeater control operator and most repeater users can advise which of 38 standard tones will activate a specific repeater.

- Holding the **[E]** key, the press the **[CALL SET]** key. A beep will be heard, and the unit is in the Set Mode.
- Press the **[FREQ]** key to get "T" on the LCD. A Tone Frequency will also appear.
 The initial factory tone frequency setting is 88.5 Hz.
- Select a desired Tone Frequency by rotating the Dial.
- Press the **[MEM]** key to complete the setting.

Sub-audible Tone Chart (unit: Hz)

67.0	71.9	74.4	77.0	79.7	82.5
85.4	88.5	91.5	94.8	97.4	100.0
103.5	107.2	110.9	114.8	118.8	123.0
127.3	131.8	136.5	141.3	146.2	151.4
156.7	162.2	167.9	173.8	179.9	186.2
192.8	203.5	210.7	218.1	225.7	233.6
241.8	250.3				

(2) Setting the Tone Encoder

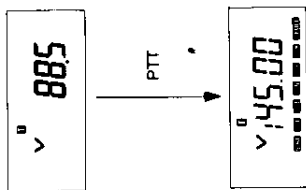

1. Press the FREQ key in the Set Mode. A tone frequency will also appear on the LCD.
2. Select a desired tone frequency.
3. Return to the transmit frequency by pressing the VW key.
4. Press the PTT key to transmit.

(3) Tone Squelch

This function is used to open the receiver squelch whenever another station transmits the tone frequency the transceiver is programmed to receive. In the Tone Squelch Mode the listener may monitor a busy channel silently. Only signals transmitting the same Tone Squelch Frequency can be received.

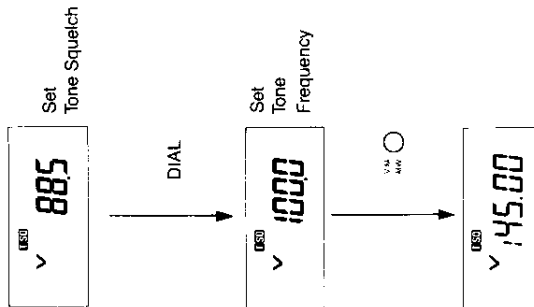

1. Press the FREQ key in the Set Mode. A tone frequency will also appear on the LCD.
2. Repeat Steps 2 and 3 above.
3. The Tone Squelch Frequency is now stored. Only signals transmitted with the selected Tone Squelch code will be heard.
4. Ensure that stations the listener wishes to hear are transmitting the correct Tone Frequency or they will not be heard.

(4) Tone Scan (EJ-12U is necessary)

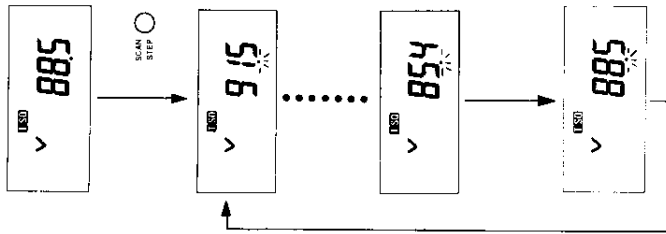

1. Press the FREQ key in the Set Mode. " FREQ " and the Tone Frequency will appear on the LCD.
2. Press the SCAN STEP key, and the frequency decimal point will flash. Then Tone Scan will start.
3. While scanning, if a signal is received and its Tone coincides with yours, the scanning will stop.
4. To resume scanning upward rotate the dial clockwise. To resume it downward rotate the dial counterclockwise.
5. To release Tone Scan press either the SCAN STEP key or the VW key.
6. Press the VW key to display the receive frequency.

4-12 MEMORY SHIFT FUNCTION

This function allows you to copy Memory Data and Call Channel Data into VFO. VFO data can be copied into Call Channel.

Setting

1. Holding the E key, press the CALL key. A beep will be heard, indicating that the unit is in the Set Mode.
2. Holding the E key, press the VW key. Data will be copied.
3. Press the VW key to return to the original frequency.

Memory Shift

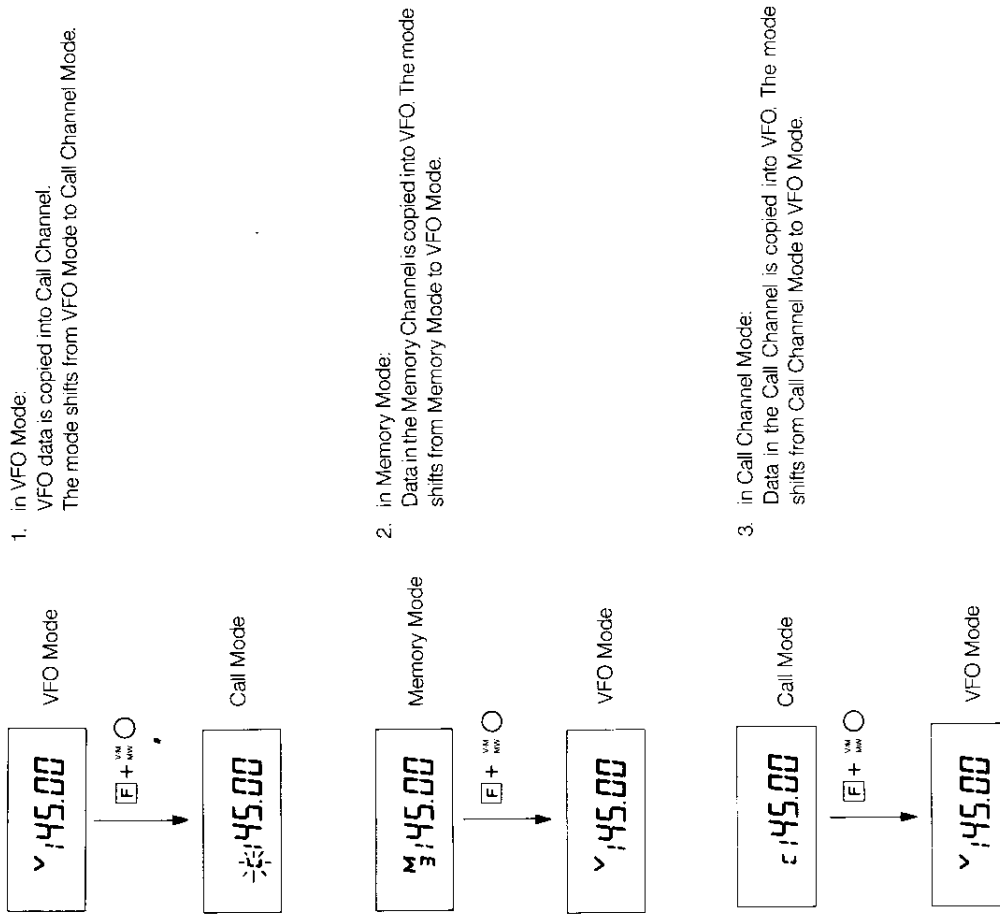

- Operation frequency range can be set, as desired.
- Holding the $[E]$ key, press the CALL key. A beep will be heard to indicate that the unit is in the Set Mode.
 - Holding the $[E]$ key, press the AMP key. " L " as a Memory Number will appear on the LCD and " M " or " " will disappear.
 - Rotate the dial to select the desired lower frequency.
 - Holding the $[E]$ key, press the MEM key. A beep will be heard indicating that the frequency is stored.
 - Press the CALL key to change " L " into " H " on the LCD.
 - Repeat the 3 and 4 to set the higher frequency.
 - Press the MEM key to complete the setting.

Setting

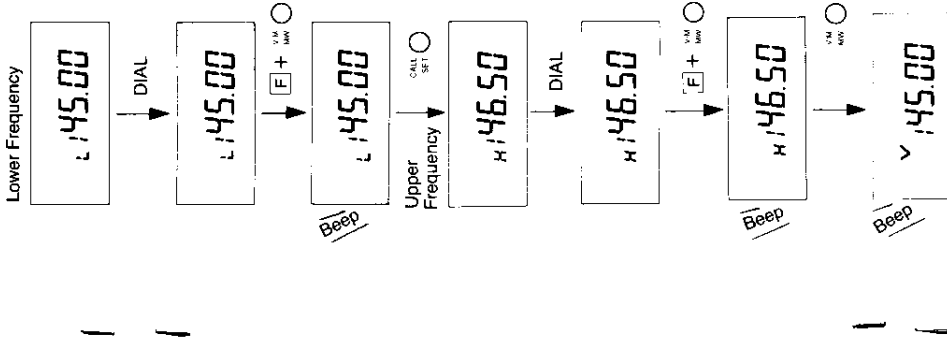

Note: When a frequency goes down lower than the VFO lower frequency, it will skip to the VFO higher limit frequency. When a frequency goes up higher than the VFO higher frequency, it will skip to the VFO lower limit frequency.

Releasing

To release the function, repeat the steps (1, 2 and 4) above.

4-16 ONE TOUCH SQUELCH DE-ACTIVATION FUNCTION

Press and hold the ^{MONT} _{BS} key to illuminate the LCD. In this mode weak signals below the squelch threshold may be heard.

4-17 LAMP

Press the ^{LAMP} key to illuminate the LCD. The lamp goes out automatically after five seconds. Lamp may also be cancelled by pressing the ^{LAMP} key again. To defeat the automatic Off feature press and hold the ^{LAMP} key, then press the ^{LAMP} key. The Lamp will remain On until it is turned off by pressing the ^{LAMP} key.

4-18 AUTOMATIC BATTERY SAVE (BS)

This very useful feature reduces unnecessary battery drain by alternating between listening and the Battery Save Mode. If there is no operation for a period of about five seconds the BS will repeat the following cycle continuously:
1. Listen for a signal for about 300 mS.
2. Battery Save for about 700 mS.

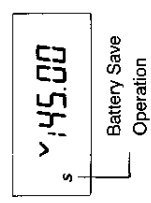

BS Operation

To activate the BS function, press and hold the ^{MONT} _{BS} key, then press the ^{MONT} _{BS} key. "S" will appear on the LCD. To cancel the BS function repeat the same step.

4-19 ON/OFF OF BEEPER

1. Press and hold the ^{MONT} _{BS} key, then press the ^{CALL} _{SET} key.
2. A beep will be heard indicating that the unit is in the Set Mode.
3. Each time the ^{LAMP} key is pressed the beep will cycle On and Off.
4. Press the ^{CALL} _{SET} key to release the Set Mode.

Note: Throughout this manual reference is made to a Beep being emitted when certain functions are activated. The Beep will sound only if the Beep function is On.

4-14 DIAL CONTROL REVERSE FUNCTION

This function allows you to change Memory Channel in VFO Mode or to change Frequency in Flashing M Mode.

1. Holding the ^{FL} key, then press the ^{CALL} _{SET} key. A beep will be heard indicating that the unit is in the Set Mode.
2. Holding the ^{FL} key, then press the ^{STEP} _{DOWN} key.
3. Press the ^{CALL} _{SET} key, the setting will be completed and the Set Mode will be released.

Setting

1. in VFO Mode
Repeating the steps (1-3) above allows you to change Memory Channel by rotating the dial.
2. in Flashing M Mode
Repeating the steps (1-3) above allows you to change frequency by rotating the dial.

Releasing the function

1. Repeat the steps (1-3) above again to release the function.

4-15 FREQUENCY LOCK (FL) AND PTT LOCK (PL)

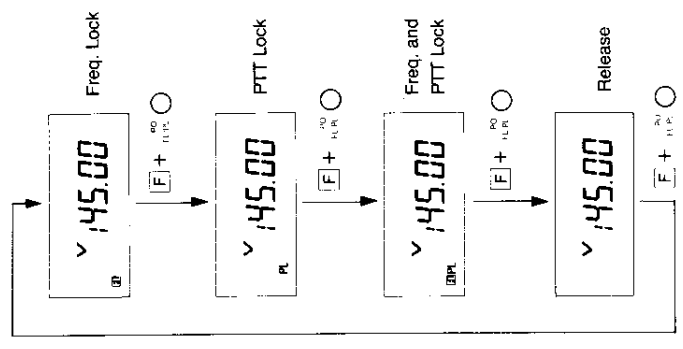

When the Frequency Lock mode is selected frequency is locked and cannot be altered. In the PTT Lock Mode the PTT switch is disabled. These are useful features to prevent unauthorized functioning or unintentional transmitting.

1. Holding the ^{FL} key, then press the ^{MONT} _{BS} key.
2. With the ^{FL} key still depressed, each time the ^{MONT} _{BS} key is pressed the LCD will cycle through FL, PL, FL and PL, and FL/PL off.
3. In the FL ON Mode, the frequency can not be changed and all control keys are locked out with the exception the PTT key, the ^{LAMP} key, the ^{MONT} _{BS} key, the ^{FL} key + the ^{MONT} _{BS} key.

5. OPERATION II

4-20 RESET

With the power off, press and hold the [F] key, then turn on the power. The unit will reset to initial factory settings as follows:

Reser Chart

	DJ-F17/E S17/E	DJ-F47/E S47/E
VFO Frequency	145.00 MHz	445.00 MHz (T version) 433.00 MHz (E version)
Memory Channel		1
Channel Step	5 kHz (T version) 12.5 kHz (E version)	
Shift Direction	None	
Offset Frequency	600 kHz	5 MHz (T version) 7.6 MHz (E version)
CTCSS Setting	None	
Tone Frequency	88.5 Hz	
DSQ Setting	None	
Call Frequency	145.00 MHz	445.00 MHz (T version) 433.00 MHz (E version)
Memory Frequency	145.00 MHz	445.00 MHz (T version) 433.00 MHz (E version)

4-21 TONE BURST (E VERSION ONLY)

Press the lower PTT key, 1.750 Hz Tone will be transmitted.

In this section, the operations using DTMF keys (Standard for F Series, Optional for S Series with ESK-1, [DTMF keypad]) are explained. For S Series, Optional DTMF Unit, E-J-10 is also necessary for the functions of 5-10 DSQ (Paging), 5-11 Digital Signal Message and 5-12 Automatic Dialer.

5-1 FREQUENCY SELECTION

There are two other ways to enter frequency other than the Dial (See 4-4 Frequency Selection).

(1) Key Pad Direct Entry

You can enter frequency by number keys (0-9).
Setting

1. Enter the number of 100 MHz.
2. Enter the number of 10 MHz.
3. Enter the number of 1 MHz.
4. Enter the number of 100 kHz.
5. a) Enter the number of 10 kHz. If the Channel Step is 10 kHz or higher, a beep will be heard to indicate the entry is done.
b) If the channel Step is 5 kHz, enter the number of 1 kHz, a beep will be heard to indicate the entry is done.

Note: When the programmed Channel Step is:

- 5 kHz Entry of 1 kHz is necessary. Only the $\overset{0}{\text{0}}$ key and the $\overset{0}{\text{0}}$ key are available at 1 kHz.
- 12.5 kHz Entries of the $\overset{0}{\text{0}}$ key and the $\overset{0}{\text{0}}$ key are not available.
- 15 kHz Entries of the $\overset{0}{\text{0}}$ key, the $\overset{0}{\text{0}}$ key, and the $\overset{0}{\text{0}}$ key at 10 kHz are not available.
- 20 kHz Only the $\overset{0}{\text{0}}$ key, the $\overset{0}{\text{0}}$ key, the $\overset{0}{\text{0}}$ key, and the $\overset{0}{\text{0}}$ key are available at 10 kHz.
- 25 kHz Only the $\overset{0}{\text{0}}$ key, the $\overset{0}{\text{0}}$ key, the $\overset{0}{\text{0}}$ key, and the $\overset{0}{\text{0}}$ key are available at 10 kHz.

6. To cancel the entry data press either the $\overset{0}{\text{0}}$ key or the PTT key, the frequency will return to the former one.

Changing the setting of entry

Frequency entry should be started from 100 MHz digit, however, you can change it from 1 MHz digit.

1. Holding the [F] key, press the $\overset{0}{\text{0}}$ key to put the radio in the Set Mode.
2. Press the $\overset{0}{\text{0}}$ key.
3. By pressing the $\overset{0}{\text{0}}$ key to release the Set Mode.
4. Repeat the steps of 1-3 to return the original setting.

(2) Up/Down Key Entry

1. Press the key, frequency will be increased by the Channel Step.
 2. Press the key, frequency will be decreased by the Channel Step.
 3. Holding the key, press the key, Frequency increases by 100 kHz.
 4. Holding the key, press the key, Frequency decreases by 100 kHz.
- Note:** If you hold these keys for 1-3 seconds, the radio will go into the Band Scan Mode with the exception of 100 kHz Up/Down Mode.

5-2 RETRIEVING OF MEMORY CHANNEL

(1) Retrieving with Key Pad

Memory Mode

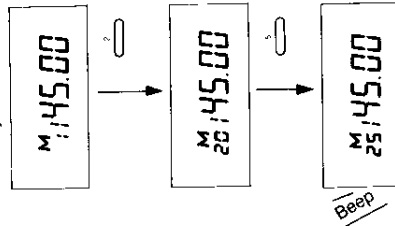

1. Enter two digits of Memory Channel Number by Key Pad. (Ex.)
Memory # 5 Enter "0", "5"
Memory # 16 Enter "1", "6"
2. After entering the first digit, press the key or the PTT key, the Memory Channel will return to the former one.

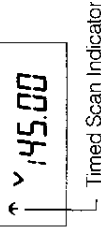

(2) Selection of Scanning Mode

1. Pressing the key, press the key, " " will appear on the LCD.
The unit will scan by Timed Scan.
 2. Pressing the key, press the key again, " " will disappear. The unit will scan by Busy Scan.
- The Modes can be switched while scanning.

(3) Memory Skip

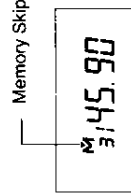

- Memory Skip allows any unnecessary Memory Channels to be skipped during Memory Scanning.
1. Press the key to put the radio in the Memory Mode.
 2. Select an unnecessary Memory Channel.
 3. Holding the key, press the key.
 4. " " will appear above " M " on the LCD.
 5. To restore a memory channel programmed to Skip repeat Step 3.

(4) Operation while Scanning

Switching the Scanning direction

1. Rotate the dial clockwise or press the key to switch the direction upward.
2. Rotate the dial counterclockwise or press the key to switch the direction downward.

Switching the Scan Mode (Timed Scan and Busy Scan)

Release the Scanning

- Press the key or the key or the PTT key.

(2) Retrieving with Up/Down Key

5-3 SCANNING (1) UP/DOWN key Band Scan

can be activated in the VFO Mode, the Flashing " " Mode, and the Flashing " M " Mode. In the Flashing " M " Mode, the dial function must be reversed (See 5-15).

Memory Scan

can be activated in the Memory Mode.

5-4 PRIORITY WATCH FUNCTION

(1) VFO Priority

In this mode a VFO frequency is received for 5 seconds and a Memory Frequency is received for 0.5 second in a continuous cycle.

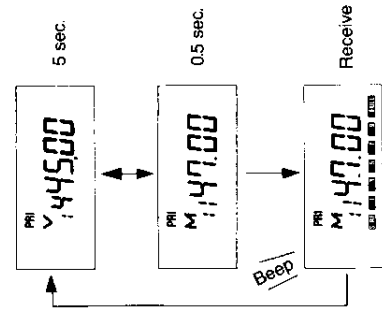

1. Press the **V/M** key to put the radio in the Memory Mode.
2. Select a desired Memory Channel Number.
3. Press the **PRI** key to return to VFO Mode.
4. Enter desired VFO frequency.
5. Press the **PRI** key to start the Priority function. In this mode the radio listens alternately to the VFO frequency for 5 seconds and to the Memory frequency for 0.5 second.
6. When a signal is received on the Memory Frequency a Beep will be heard and the signal is held for 3 seconds.
7. To stop the Priority function press the **PRI** key in the VFO Mode.

"**PRI**" on the LCD will be disappeared.

(2) Memory Priority

This mode is the reverse of VFO Priority.

The Memory Frequency is received for 5 seconds and the VFO Frequency is received for 0.5 second.

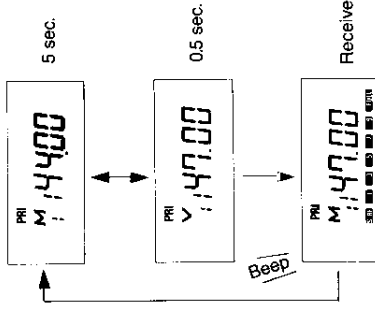

1. Press the **V/M** key to put the radio in the VFO Mode.
2. Enter a desired VFO frequency.
3. Press the **V/M** key to put the radio in the Memory Mode.
4. Select a desired Memory Channel.
5. Press the **PRI** key to start the Priority function. In this mode the radio listens alternately to the Memory frequency for 5 seconds and to the VFO frequency for 0.5 second.
6. When a signal is received on the VFO frequency a Beep will be heard and the signal is held for 3 seconds.
7. To stop the Priority function press the **PRI** key in the Memory Mode.

"**PRI**" on the LCD will be disappeared.

(3) Call Priority

In this mode Call Watch cycles between the Call Channel Frequency and another frequency selected from the VFO or the Memory Channel.

1. Press the **V/M** key to put the radio in either VFO Mode or Memory Mode.
2. Select either a desired VFO frequency or a desired Memory Channel on the LCD.
3. Press the **CALL** key to put the radio in Call Channel Mode.
4. Press the **PRI** key to start Call Priority function.
5. "**PRI**" will appear on the LCD.
6. In this mode the radio listens alternately to the Call Channel Frequency for 5 seconds and to the VFO or Memory Channel Frequency for 0.5 second.
7. When a signal is received on the VFO frequency (or the Memory frequency) a beep will be heard and the signal is held for 3 seconds.
8. To stop the Call Priority function press the **PRI** key in Call Channel Mode.

"**PRI**" on the LCD will be disappeared.

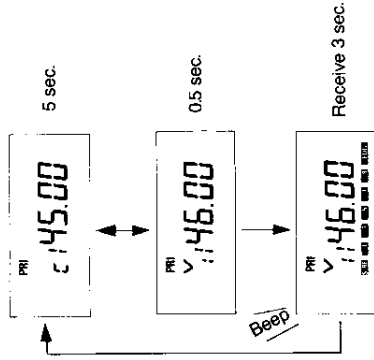

(4) Operations while Priority Function is active

Transmit during the 5 seconds scan cycle

1. In every Priority the transmitter may be activated on each frequency.
2. Press the PTT when the desired frequency is displayed on the LCD. When the PTT is released the Priority function resumes after 5 seconds.

Transmit during the 0.5 second scan cycle

1. When the desired frequency is displayed on the LCD, you can press the PTT to transmit; however, it results to stop the Priority Function.

Changing the VFO Frequency or the Memory Channel during the 5 seconds scan cycle

1. Rotate the dial to increase or decrease the VFO Frequency or the Memory Channel.

Releasing the Priority Function

To stop the Priority Function press either the **PRI** key or the **V/M** key during the 5 seconds cycle or press the PTT key during the 0.5 second cycle.

(5) Simultaneous Priority and Scan

A. Scan can be started during the 5 second scan cycle while the Priority function is active.

1. While VFO Priority Function:
 - a. Program Scan
Press the $\text{PRG} \text{STEP}$ key in the VFO Mode.
 - b. Band Scan
Release the BAND (100) key in the VFO Mode within 3 seconds after frequency repeat is started.
2. While Memory Priority Function:
 - a. Memory Scan
Press the $\text{MEM} \text{STEP}$ key in Memory Mode.
Release the MEM (100) key in Memory Mode with 3 seconds after frequency repeat is started.
3. Release while Simultaneous Priority and Scan
 - a. Press the $\text{PRL} \text{OK}$ key, only the Priority function will be released.
 - b. Press the $\text{SCAN} \text{STEP}$ key, only the Scanning function will be released.
 - c. Press the $\text{VFO} \text{STEP}$ key or press the PTT key during the 0.5 second cycle, both the Priority and the Scanning will be released.

B. Priority can be started while Scanning

1. While Program Scanning or Band Scanning in VFO
Press the $\text{PRL} \text{OK}$ key to start VFO Priority.
2. While Memory Scanning
Press the $\text{PRL} \text{OK}$ key to start Memory Priority.

5-5 SETTING OFFSET FREQUENCY

The difference between the transmit frequency and the receive frequency while operation using a repeater is called Offset Frequency.

(1) Setting Mode of Offset Frequency

1. Pressing the F key, press the OFF key, an Offset frequency will be displayed on the LCD. The initial factory settings and the settings after reset are 600 kHz for F1/E and S1/E, 5 MHz for F4T and S4T, and 76 MHz for F4E and S4E.
The Offset frequency can be selected between 0 and 15995 MHz.
2. Press the VFO key or the PTT key to release the setting mode.

(2) Selecting Offset frequency By Channel Step

Rotate the dial clockwise or press the VFO key to increase the Offset frequency by the Channel Step. Rotate the dial counter-clockwise or press the VFO key to decrease it by the Channel Step.

Pressing the F key, press the VFO key to increase the Offset frequency by 100 kHz or press the VFO key to decrease it by 100 kHz.

Pressing the F key, rotate the Dial to increase or decrease the Offset frequency by 1 MHz.

5-6 SETTING OF SHIFT DIRECTION AND SPLIT

Pressing the F key, press the SHIFT key. Each time the key is pressed, the Shift direction will change as the chart. See 4-10 for Split operation.

If " **OFF** " appears in place of the frequency during transmit, the selected offset frequency is out-of-band. The transmitter will not transmit. Reset the offset direction and frequency.

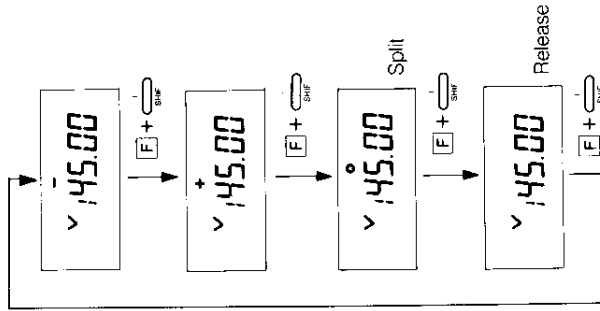

5-7 REVERSE FUNCTION

The function reverses the Transmit and Receive frequencies. The function is useful to determine if the other station is within Simplex range and you can communicate with the station without the repeater.

(1) Reverse of Shift Direction

Pressing the \boxed{F} key, press the REV key. The Transmit and Receive frequencies will be reversed and the direction will be reversed.

Note: If the Reversed frequency is out of the band, the function will not work and beep will be heard.

(2) Reverse of Split

- Pressing the \boxed{F} key, press the REV key. The Transmit and Receive frequencies will be reversed.
- Only the PTT key, the REV key, the REV key, the REV key, and the \boxed{F} key + the REV key are available while Split Reverse. If other keys are pressed, a beep will be heard and the Split Reverse will be released.

5-8 SETTING OF TONE FREQUENCY

A desired Tone frequency can be selected among 38 Standard Tone with this function.

- Pressing the \boxed{F} key, press the TONE key, a Tone frequency will be appeared on the LCD.
- Press the REV key or rotate the dial clockwise to increase the Tone frequency. Press the REV key or rotate the dial counterclockwise to decrease it.
- Press the REV key or the PTT key, the setting mode will be released.

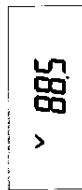

Sub-audible Tone Chart (Unit: Hz)

67.0	71.9	74.4	77.0	79.7	82.5
85.4	88.5	91.5	94.8	97.4	100.0
103.5	107.2	110.9	114.8	118.8	123.0
127.3	131.8	136.5	141.3	146.2	151.4
156.7	162.2	167.9	173.8	179.9	186.2
192.8	203.5	210.7	218.1	225.7	233.6
241.8	250.3				

5-9 TONE ENCODER AND TONE SQUELCH

- Both Tone Encoder and Tone Squelch are optional for E version. EJ-12U (Tone Squelch Unit) is necessary.
- Tone Squelch is optional for T version.

Pressing the \boxed{F} key, press the REV key. Tone settings will cycle each time the REV key is pressed as the chart. See 4-11 for Tone Encoder and Tone Squelch functions.

Tone Scan (EJ-12U is necessary).

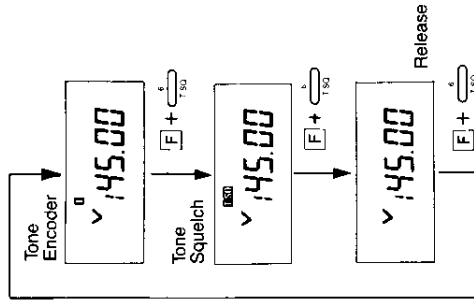

- Pressing the \boxed{F} key, press the REV key, "145.00" will appear on the LCD.
- Pressing the \boxed{F} key, press the TONE key, a Tone frequency will appear on the LCD.
- Press the REV key, the frequency decimal point will flash and Tone Scan will start.
- While scanning, if a signal is received and its Tone coincides with yours, the scanning will stop.
- To resume scanning upward rotate the dial clockwise or press the REV key. To resume it downward rotate the dial counterclockwise or press the REV key.
- Press the REV key again or the REV key, the scanning will be released.

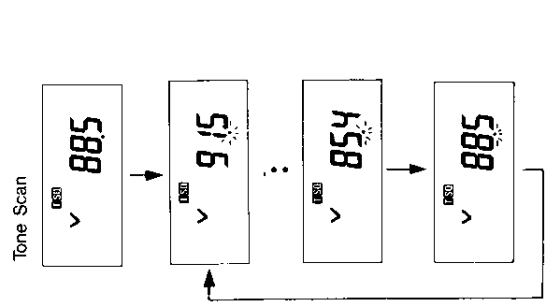

5-10 DSQ FUNCTION: PAGING

Optional DTMF Unit Eu-10U is also necessary for S Series. This mode is used for paging or code squelch.

(1) Paging Function Group Calling

Use this mode to call all members of a specific group.

Private Call in a group

In this mode a single person in a group is called.

Private Call

In this mode a single person is called.

(2) Code Squelch Function

By transmitting a frequency with three digits code the unit will be operating the same function as a tone squelch function.

(3) DSQ Code

- Three Digit Group Code
This code is common to all members of the group. This code is also used as a Code Squelch.
- Three Digit "Own" Code
This is a personal code to receive private calls.
- Three Digit "Other's" Code
This code is used to call a specific person. It is the other person's "Own" code.

16 numbers, letters and symbols can be used for the codes.

They are:

An "H" will appear on the LCD when "X" is entered and "B" appears when "#" is entered. " # " is used as a "Wild Card" (See (8) in this section).

(4) Setting DSQ Code

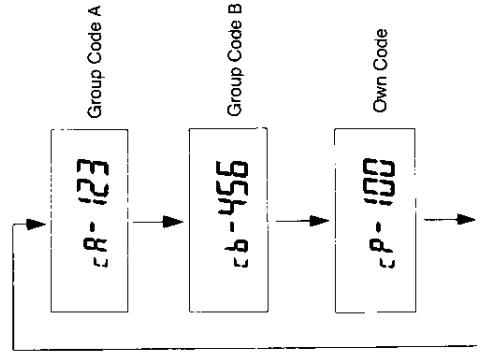

- Press and hold the [F] key, then press the [G] or [B] key. DSQ Code will appear on the LCD.
- By rotating the dial clockwise, the DSQ Code will cycle as the chart.

- A: Group Code A
B: Group Code B
P: Own Code
Y: Other's Code

1M: Digital Signal Message 1

2M: Digital Signal Message 2

- Holding the [E] key, pressing the [M] or [M] key will also cycle as the chart.

4. Enter three digit DSQ codes into the Codes.

Enter two digit DSQ Codes into the Digital Signal Message. To cancel the code holding the [F] key and press the [M] or [M] key.

- Press the [M] or [M] key to return to display frequency, the setting mode will be released.

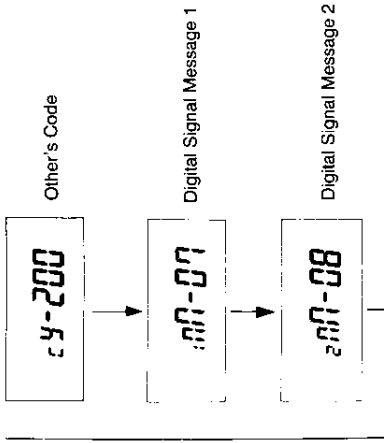

(5) Setting DSQ

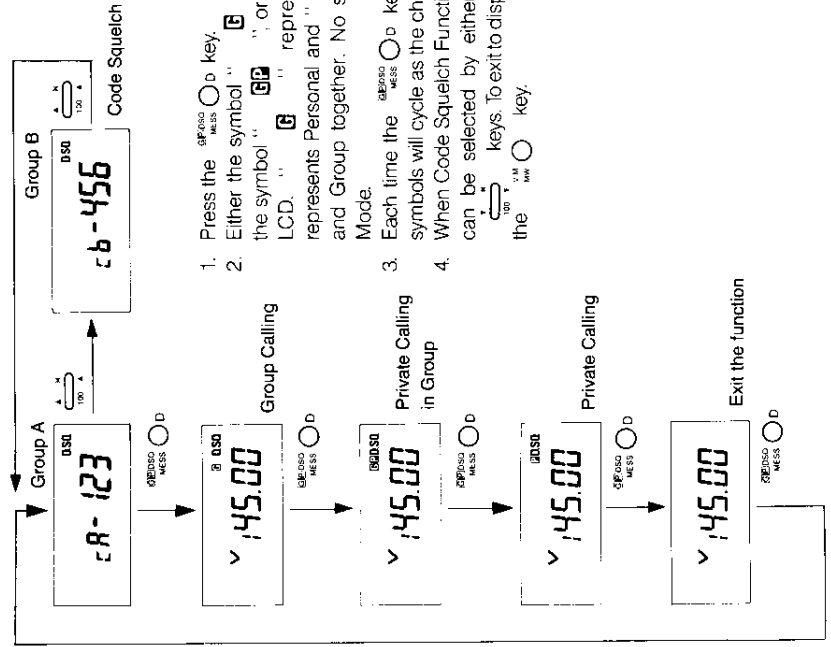

- Press the [M] or [M] key.
- Either the symbol "C" or the symbol "B" will appear on the LCD. "C" represents Group. "B" represents Personal and "CB" indicates Personal and Group together. No symbol indicates out of DSQ Mode.
- Each time the [M] or [M] key is pressed the DSQ Mode symbols will cycle as the chart.
- When Code Squelch Function is set, Group Code A or B can be selected by either the Dial or the [M] or [M] keys. To exit to display operation frequency press the [M] or [M] key.

(6) Operation of Paging

< TRANSMITTING >
Before Transmitting

1. Holding the **F** key, press the **DSQ SET** key to put the radio in the DSQ Code setting mode.
2. Set Group Code, Own Code, Others Code.
3. Press the **MEMO** key to return to the operation frequency.

Group Code A
cA-123

Own Code
cP-100

Other's Code
cY-200

Transmitting (Group Calling)

1. Press the **MEMO** key to display Group Code on the LCD.
2. By rotating the Dial, select either Group Code A, or Group Code B.
3. Press the **DSQ** key until "G" and "DSQ" appear on the LCD.
4. When the above setting (1-3 Before Transmitting) is complete the DSQ code is transmitted automatically when the PTT key is pressed. The transmitted DSQ code is shown here:
1 2 3 * 1 0 0

Select Group Code
cA-123

Set Group Calling
v 145.00

Transmitting (Private Calling in a Group)

1. Press the **MEMO** key to display Group Code.
2. By rotating the Dial, select either Group Code A, or Group code B.
3. Press the **DSQ** key until "G" and "DSQ" appear on the LCD.
4. When the PTT key is pressed the DSQ code is transmitted automatically. The transmitted DSQ code is shown here:
1 2 3 2 * 1

Select Group Code
cA-123

Set Private Calling in a Group
v 145.00

Transmitting (Private Calling)

1. Press the **MEMO** key until "P" and "DSQ" appear on the LCD.
2. When the PTT key is pressed the DSQ code is transmitted automatically. The transmitted DSQ code is shown here:
2 0 0 * 1 0 0

Private Calling
v 145.00

< RECEIVING >

To receive DSQ coded calls select either Group Calling, "G" or Private Calling, "P", or Private calling in a Group, "GB".

Receiving (Group Call)

1. When the received DSQ code matches the Group Code "G" flashes on the LCD and a Beep sounds to alert the listener to an incoming call.
2. When an incoming call is received the DSQ code is displayed on the LCD. The displayed code will be the Group code.

cA-123

Receiving (Private Call in a Group)

1. When an incoming DSQ coded call matches both the Group code and the highest digit of the "Own Code" "GB" will flash on the LCD and a Beep will alert the listener to an incoming private call. The DSQ code will be displayed on the LCD.

cA-123

Receiving (Private Call)

1. When an incoming DSQ coded call matches the Own code "G" will flash on the LCD and a Beep sounds to alert the listener to an incoming call.
2. The "Other's Code" will be displayed on the LCD.

cY-200

Transmitting the DSQ code

When the PTT key is pressed the selected DSQ code will be transmitted with the signal.

When "Other's" Code is not confirmed

cA-123

(7) Code Squelch Operation

1. Press and hold the **F** key, then press the **DSQ SET** key to select the DSQ code setting mode.
You can select either Group Code A or Group Code B.
2. Enter a three digit Code Squelch code using the key pad.
3. Press the **MEMO** key to return the LCD to frequency.
4. Press the **DSQ** key until "DSQ" appear on the LCD.
5. When the PTT key is pressed the Code Squelch code is transmitted automatically with the signal.

Select Code Squelch Code
cB-456

Set Code Squelch
cB-456

Receiving
cB-456

6. If received Code Squelch signal matches the set Code Squelch code "DSQ" will flash on the LCD and a Beep sounds to alert the listener to an incoming signal.
7. The Group Code will be displayed on the LCD.
8. Press the **MEMO** key to return the LCD to frequency.

(8) Wild Card Function

The " # " (" B ") symbol is a wild card that may be substituted for any one of numbers, letters or symbols used in DSQ codes. " # " may also be used to represent all three code digits. " # " may also replace the group code in group calling and the code squelch code in the Code Squelch mode.

Example:

1. Enter the Group Code A " 1 # 5 ".
2. Select the Code Squelch mode.
3. If the incoming coded call is any one of the following groupings the call will be received: "105 through 195", "1A5 through 1D5", " 1 * 5 " or " 1 # 5 ".

- Note:**
1. The time delay to transmit the DSQ code after the PTT key is pressed is about 450 mSec.
 2. Transmission time of the DSQ code is about 360 mSec.
 3. To activate the DSQ function properly adjust squelch control clockwise until " **DSQ** " will disappear on the LCD.
 4. LCD should display the operating frequency while DSQ function is activated.

(9) Selecting time delay

You can select the time delay to transmit the DSQ code after pressing the PTT key.

1. Holding the **[F]** key, then press the **[SET]** key to put the radio in Set Mode.
2. Press the **[OFF/SET]** key to change the time delay from approx. 450 mSec. to approx. 750 mSec.
3. Press the **[MEM]** key to return to display operating frequency.
4. By the same steps the delay can be returned to approx. 450 mSec.

(10) Transmitting DTMF Signal **[C]** Function

This function allows you to transmit a DTMF tone (" **[C]** ") automatically for a bit of time after the PTT is released.

1. Holding the **[F]** key, then press the **[SET]** key to put the radio in Set Mode.
2. Press the **[MEM]** key.
3. Press the **[MEM]** key to complete the step.
4. When the PTT key is released from transmitting, the DTMF tone (" **[C]** ") will be automatically transmitted for a bit of time indicating that the transmission is over.
5. By the same steps, the functions can be released.

5-11 DIGITAL SIGNAL MESSAGE FUNCTION

This function allows you to send or receive messages consists of 2 digit code in Paging mode. Optional DTMF Unit EJ-10U is necessary for S Series.

(1) Setting transmit message

Two messages can be stored in the transmitter memory.

1. Holding the **[F]** key, then press the **[DSQ/SET]** key to put the radio in DSQ Code set mode.
2. Rotate the Dial to select a message memory channel.
3. Enter the two digit message code.
4. Press the **[MEM]** key to release the setting mode.

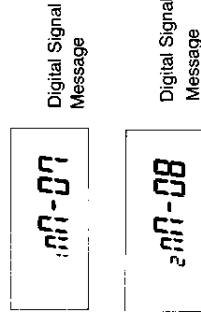

Transmitting Digital Signal Message

1. Set a transmitting message.
2. Set Paging Function. (See to 5-10 (6) Operation of Paging). (Paging).



PTT ON - PTT + **[SET]** or **[MEM]**

3. Press the PTT key to transmit the DSQ code.
 4. Holding the PTT key, press either the **[SET]** key or the **[MEM]** key.
- The transmitted Digital Signal Message code is shown here:

0 7 **[RECEIVING]** Digital Signal Message 1

Pressing the **[SET]** key: Digital Signal Message 1
Pressing the **[MEM]** key: Digital Signal Message 2

Receiving Digital Signal Message

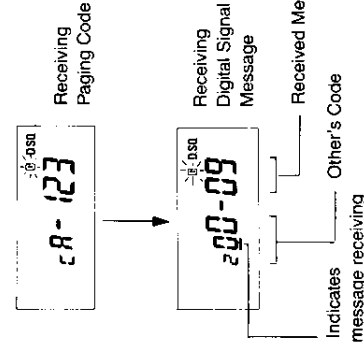

1. Set Paging Function.
2. In the Paging Function mode when the " # " code and two digit DTMF code are received after Other's Code" are sent from sender, "Other's Code" and Digital Signal Message will display on the LCD.
3. " # " will also appear on the LCD.

Releasing Alarm and Flashing Alert

1. Press the **MEM** key to silence the alarm and stop the flashing alert. LCD will display operation frequency.
2. Press any key except the **MEM** key to silence the alarm.

Digital Signal Message Memory

1. You can store up to three received digital signal messages in the memory.
2. The first 2 channels store the messages in received order.
3. The third channel stores the latest one.
3. No same messages are stored again.

Displaying Digital Signal Message Memory

1. Holding the **F** key, then press the **MEM** key. The latest message will appear on the LCD.
2. Rotate the Dial clockwise/counterclockwise to display next/previous message on the LCD display.
3. Press the **MEM** / **MEM** key to do the same as above.

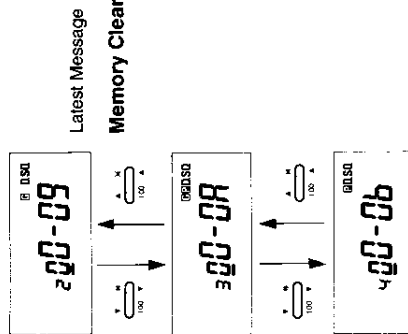

Memory Clear

1. Holding the **F** key, then press the **MEM** key. The memory will be cleared.
2. When all memories are cleared "—" on the LCD will disappear.
3. LCD displays operation frequency.

Release of Display mode

Press the **MEM** key, the mode will be released and the frequency will appear on the LCD.

Transmitting while Digital Signal Message is Displayed

While a Digital Signal Message is displayed, press the PTT key, a signal will be transmitted in the displayed DSQ setting (Pager). Other's code will be changed to the displayed other's code. The frequency will be displayed.

Entering a Telephone Number

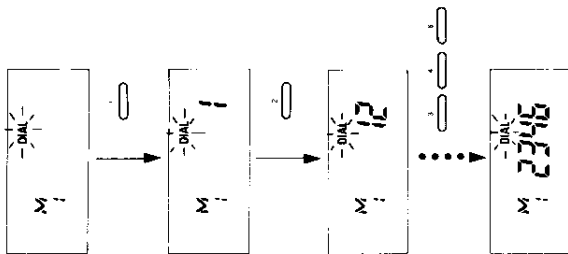

1. Holding the **F** key, then press the **DIAL** key. The unit is in Dial No. Entering Mode, and "DIAL" will flash.
2. Rotate the dial clockwise/counterclockwise to increase/decrease the memory number.
3. Dial Memory 1-3..... Automatic Dialer Memory Dial Memory 4..... DTMF Monitor Memory
4. 16 numbers, letters and symbols can be used for the codes.
5. You cannot enter the code into Dial Memory 4.
6. The entered number is stored by pressing the **DIAL** key. The LCD will return to frequency and "DIAL" becomes steady indicating that the dialer memory contains a stored number.

Modification of Dial No. while entering

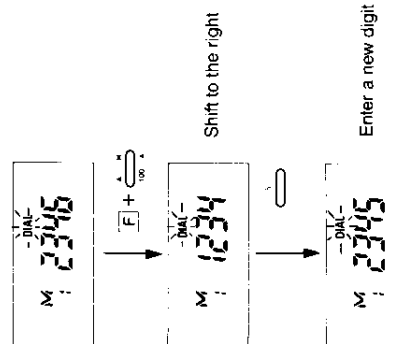

1. Pressing the **F** key, press the **DIAL** key. Each time the **DIAL** key is pressed, the code shift to the right by 1 digit.
 2. Pressing the **F** key, press the **DIAL** key to shift the code to the left by 1 digit.
 3. Press the **DIAL** key or the **DIAL** key until the digit that should be modified disappears.
 3. Enter a new digit. The code will shift to the left by 1 digit and the new digit will appear.
- EX. ① "1, 2, 3, 4, 6" were entered "2, 3, 4, 6" are displayed.
 ② "6" should be modified to "5".
 ③ Shift the code until "1, 2, 3, 4" are displayed.
 ④ Enter "5".

5-12 AUTOMATIC DIALER FUNCTION

The F Series offers four automatic dialer channel. Optional DTMF Unit, EJ-10U is necessary for S Series. Telephone numbers can be entered in these memory. One of these memories is used for DTMF monitoring.

Clearing of Entered Code

Pressing the **[F]** key, press the **MEM** key, the entire entered code in the channel will be cleared.

Transmitting a stored Telephone Number

1. Holding the **[F]** key, then press the **MEM** key.
2. Rotate the dial to select Dial Memory No. to transmit.
3. Press the **PTT** key to return to the frequency.
4. Holding the **PTT** key, press the **[F]** key.
5. The selected telephone number will be transmitted automatically.
The intervals between each transmitted dialing number are approx. 60 mSec.

DTMF Monitoring Function

This function allows you to decode the DTMF code in Dial Memory 4 on the LCD.

1. Set either DSS mode or DIAL mode.
2. If the unit receives DTMF code it will be displayed on the LCD.

Displaying decoded DTMF Code

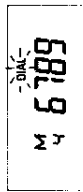

1. Holding the **[F]** key, then press the **MEM** key.
2. Rotate the Dial to select Memory Channel No. 4.
3. Holding the **[F]** key, then press the **DTMF** key. The decoded code will be shifted to the right.
4. Holding the **[F]** key, then press the **DTMF** key. The decoded code will be shifted to the left.
5. Press the **MEM** key to return to the frequency.
6. After reversing the Dial control (See 5-15) in the Dial No. Entering mode (**[F]** + **MEM**), the code can be shifted by the dial. Follow the same steps to return the dial control to change Memory No.

5-13 AUTOMATIC POWER OFF (APO) FUNCTION

The APO function prevents inadvertent waste of battery power when the radio is left ON unintentionally.

Setting APO

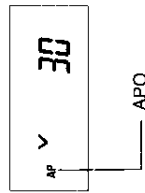

1. Holding the **[F]** key, then press the **AP** key. "AP" will appear on the LCD.
The initial factory APO timer setting is 30 Minutes.
2. By rotating the Dial, APO timer can be set in the range of 5 to 60 minutes by 5 minutes step.
3. Press the **MEM** key to activate the APO function.
4. To cancel APO pressing the **[F]** key, press the **MEM** key again. "AP" on the LCD will disappear.

Automatic Power Off

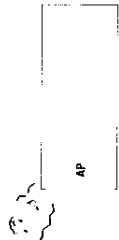

1. After the set time of APO of no activity passes, a beep will be heard and the LCD goes off except "AP".
Battery power is now OFF, then "AP" will disappear.
2. To turn radio ON again, turn OFF the power switch then turn ON the power again.
3. APO function will be cancelled.

5-14 MEMORY SHIFT FUNCTION

1. Pressing the **[F]** key, press the **MEM** key, the data will be copied to CALL channel and the radio will be in CALL mode.
2. Pressing the **[F]** key, press the **MEM** key, the data will be copied to VFO and the radio will be in VFO mode.
3. Pressing the **[F]** key, press the **MEM** key, the data will be copied to VFO and the radio will be in VFO mode.

5-15 DIAL CONTROL REVERSE FUNCTION

Pressing the **[F]** key, press the **REV** key, the function of the dial in the mode will be reversed as follows and by the same step it will return to the original function.

VFO Mode

Frequency Selection → Memory Channel No. Selection

Memory (Flashing M) Mode

Memory Channel No. Selection → Frequency Selection

Dial No. Setting Mode

Dial Memory No. Selection → Dial No. Shift

5-16 ON/OFF OF BEEPER

1. Pressing the **[F]** key, press the **BEEP** key, no beep will be heard even if any key is pressed.
2. Pressing the **[F]** key, press the **BEEP** key again, beep will work.

6. REMOTE CONTROL MICROPHONE (Optional Speaker/Microphone EMS-8 is necessary.)

The operation of Optional EMS-8 is explained in this section.

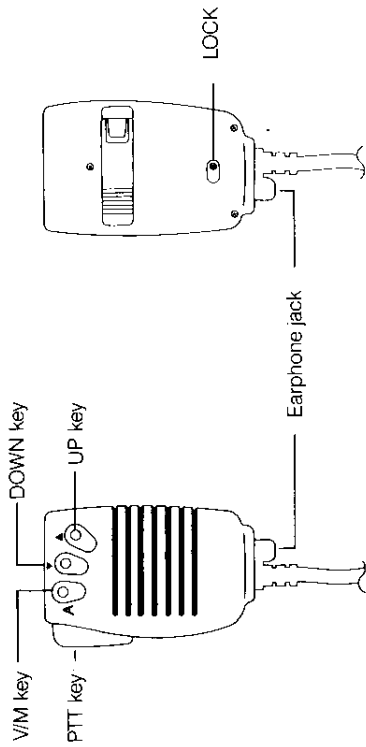

- V/M key** Selection of VFO mode and Memory Mode Completion of the settings
- UP key** Increases frequency or Memory channel No.
- DOWN key** Decreases frequency or Memory channel No.
- LOCK** Locks the V/M key, the UP key, and the DOWN key on the EMS-8.

- Note**
- ① Holding the UP/DOWN key for 1-3 second will start Scanning.
 - ② Frequency Lock function of the main unit can not work in the EMS-8.
 - ③ Connecting or disconnecting of EMS-8 to the main unit while the power is on may change the frequency and the Memory channel No. Connect or disconnect it to the main unit after the power is turned off.

7. ATTACHING OPTIONAL ACCESSORIES

7-1 DTMF UNIT EJ-10U (Standard for F Series) AND TONE SQUELCH UNIT EJ-12U

1. Remove the 5 screws in the Fig. 1.

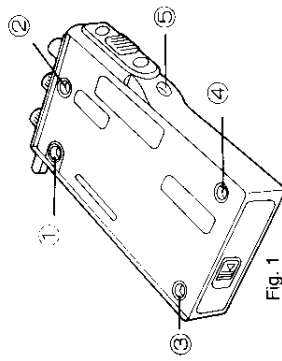

Fig. 1

2. Holding the Battery Pack (Dry Cell Battery Case) Lock as indicated by Arrow 1, in Fig. 2, open the unit by holding the antenna connector as Fig. 2. The unit will be as Fig. 3.

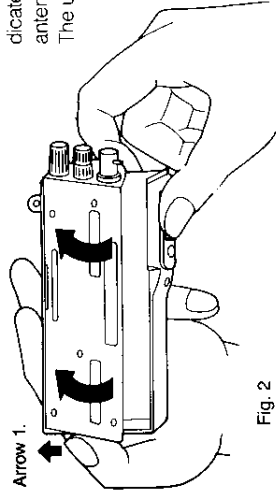

Fig. 2

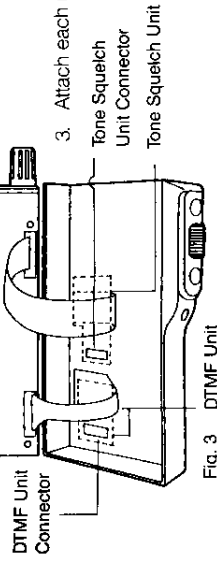

Fig. 3

3. Attach each unit to its place indicated in Fig. 3.

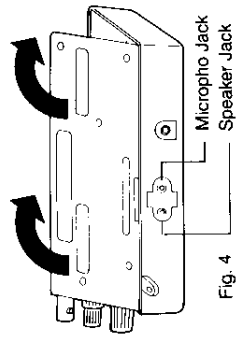

Fig. 4

4. Insert the speaker jack and the microphone jack in their holes and close the unit as Fig. 4.

5. Attach the 5 screws removed in 1.

7-2 DTMF KEY PAD ESK-1 (B)
(Standard for F Series)

1. Follow the steps 1 and 2 in 7-1.
2. Remove the 2 screws in Fig. 5 and 6.
3. Remove the cover as in Fig. 5 (Push the cover through the screw hole with a sharp-pointed object.)
4. Attach the keypad to the unit as in Fig. 7.
5. Attach the 2 screws removed in 2.
6. Follow the steps 4 and 5 in 7-1.

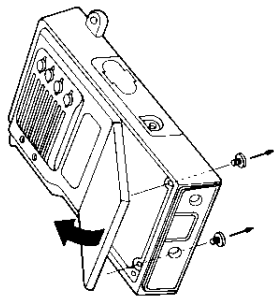

Fig. 5

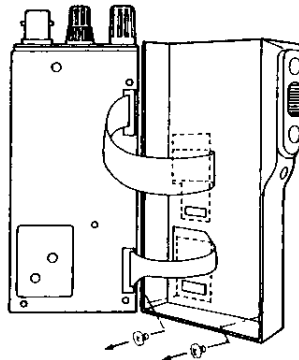

Fig. 6

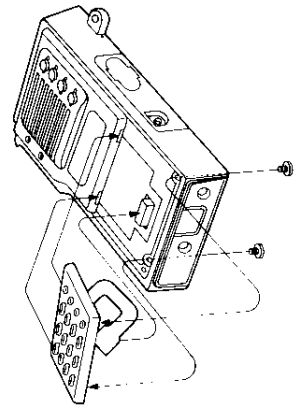

Fig. 7