

ALINCO

RECEIVER

DJ-X1

INSTRUCTION MANUAL

ALINCO ELECTRONICS INC.

438 Amapola Avenue, Unit 130, Torrance, CA 90501, U.S.A.

Phone: (310) 618-8616

1-1-1 Mishimae, Takatsuki city, Osaka 569, Japan

ALINCO ELECTRONICS INC.

TABLE OF CONTENTS

INTRODUCTION	pg. 1	5-5 SCAN	pg. 24
1. PRIOR TO OPERATION	pg. 1	① VFO Scan.....	pg. 24
2. ACCESSORIES	pg. 2	② Searching.....	pg. 25
2-1 STANDARD ACCESSORIES.....	pg. 2	③ Program Scan.....	pg. 26
2-2 OPTIONAL ACCESSORIES.....	pg. 2	④ Memory Scan.....	pg. 28
2-3 SETTING DRY CELL BATTERIES TO CASE.....	pg. 3	⑤ Mode Select Scan.....	pg. 29
2-4 ATTACHING DRY CELL BATTERY CASE OR BATTERY PACK (OPTIONAL) TO MAIN UNIT.....	pg. 3	⑥ Timed Scan.....	pg. 30
2-5 REMOVING DRY CELL BATTERY CASE OR BATTERY PACK (OPTIONAL) FROM MAIN UNIT.....	pg. 4	⑦ Scanning Speed.....	pg. 30
2-6 ATTACHING BELT CLIP.....	pg. 4	⑧ Memorizing Signal-Received Frequencies.....	pg. 31
3. SPECIFICATIONS	pg. 5	5-6 PRIORITY FUNCTION.....	pg. 31
4. CONTROL FUNCTION	pg. 6	① VFO Priority.....	pg. 31
4-1 KEYS, KNOBS, AND CONNECTOR.....	pg. 6	② Memory Priority.....	pg. 32
4-2 JACKS.....	pg. 10	5-7 BATTERY SAVE FUNCTION.....	pg. 32
4-3 LCD.....	pg. 11	① ON/OFF of Battery Save Function.....	pg. 32
5. OPERATION	pg. 13	② Changing the Lengths of Listening and Battery Save Mode.....	pg. 33
5-1 RECEIVING.....	pg. 13	5-8 AUTOMATIC POWER OFF FUNCTION.....	pg. 33
① Operational Mode.....	pg. 13	5-9 LAMP.....	pg. 34
1) VFO Mode.....	pg. 13	① ON/OFF of Lamp.....	pg. 34
2) Memory Mode.....	pg. 13	② Automatic Lamp Function.....	pg. 34
3) Call Channel Mode.....	pg. 13	5-10 FUNCTIONS LOCK FUNCTION.....	pg. 35
② Frequency Selection.....	pg. 13	5-11 ON/OFF OF BEEPER.....	pg. 35
1) Dial Entry.....	pg. 14	5-12 RESET.....	pg. 36
2) UP/DOWN Key Entry.....	pg. 14		
3) Key Pad Direct Entry.....	pg. 15		
③ Modulation Mode.....	pg. 16		
1) Automatic Modulation Mode Selection Function.....	pg. 16		
2) Modulation Mode Selection.....	pg. 16		
④ Volume Control.....	pg. 17		
⑤ Squelch.....	pg. 17		
1) Setting Squelch Level.....	pg. 17		
2) One Touch Squelch Deactivation Function.....	pg. 17		
5-2 CHANNEL STEP.....	pg. 17		
Channel Step Selection.....	pg. 17		
5-3 MEMORY.....	pg. 18		
① Entering A Frequency And Its Modulation Mode Into A Memory Channel.....	pg. 19		
② Retrieving A Memory Channel.....	pg. 21		
③ Memory Shift Function.....	pg. 23		
5-4 CALL CHANNEL.....	pg. 23		
① Entering A Frequency And Its Modulation Mode Into Call Channel.....	pg. 23		
② Retrieving The Call Channel.....	pg. 24		

INTRODUCTION

Thank you for purchasing the "ALINCO" Wide Band Receiver DJ-X1. ALINCO receivers and other products are ranked as some of the finest in the world. Your receiver has been manufactured and tested very carefully at the factory and will give you satisfactory operation for many years. We are confident that you will be very satisfied with your choice of this fine ALINCO receiver.

1. PRIOR TO OPERATION

Cautions

- Never operate the unit under the direct rays of the sun, near heater, or in a dusty or humid environment.
- Use ALINCO's optional accessory EDC-36 (Mobile DC Power Cable/Charger with Noise Filter) for operation with car power source.

Notes

- As the unit is a wide band receiver and the unit may receive its own signals of inner oscillation circuit, signals may not be received or noise may come out at some frequencies.
- When an outer antenna and/or RF amplifier are/is used with the unit or when a strong signal is near the unit, receiving may be interrupted.

2. ACCESSORIES

2-1 STANDARD ACCESSORIES

Carefully unpack your receiver and you will find the standard accessories included:

- ① Dry Cell Battery Case..... EDH-5
- ② Low Band Antenna EA-17
- ③ High Band Antenna EA-18
- ④ Belt Clip (with Screws) EBC-3
- ⑤ Hand Strap

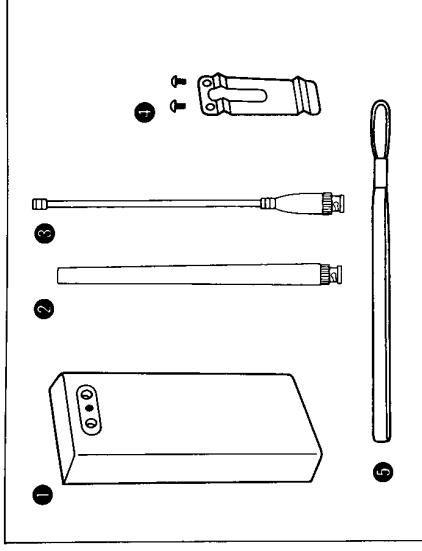

Note:

Select a suitable antenna depending on the frequency.

Low Band Antenna ②: 0.5 ~ 150 MHz
High Band Antenna ③: 100 MHz ~

2-2 OPTIONAL ACCESSORIES

The following optional accessories are available for DJ-X1.

- Ni-Cd Battery Pack (7.2V 700 mAh) EBP-16N
- Ni-Cd Battery Pack (7.2V 400 mAh, Thin Type) EBP-14N
- AC Wall Charger EDC-24 (120V)
EDC-25 (220V)
EDC-34 (120V)
EDC-35 (220V)
- AC/DC Quick Charger (1 hour Type) EDC-36
- Mobile DC Power Cable/Charger w/Noise Filter EDC-43
- Mobile DC Power Cable/Charger EDC-43
- Earphone EME-6
- Shoulder Belt w/Soft Case EBC-5
- Cable for Power Supply at 138V EDC-37

2-3 SETTING DRY CELL BATTERIES TO CASE

- 1 Remove the cover of the dry cell battery case
- 2 Set 6 AA Dry Cell Batteries in accordance with the directions indicated in the case
- 3 Attach the cover to the case

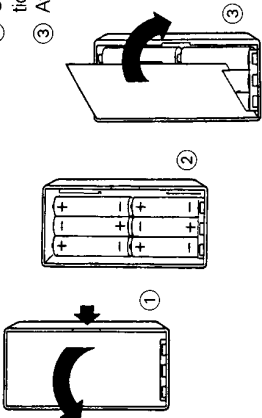

2-5 REMOVING DRY CELL BATTERY CASE OR BATTERY PACK (OPTIONAL) FROM MAIN UNIT

1. Unlock the Battery Lock Button Hook as indicated in the fig. a-1.
2. Slide the Battery Lock Button as indicated in fig. a-4 and hold, then remove the pack or the case as indicated by the arrow in fig. a-3.

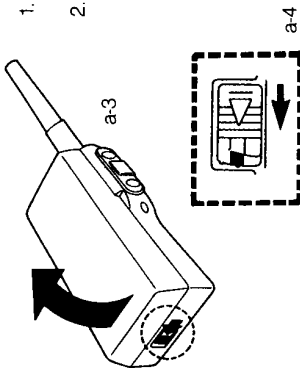

2-4 ATTACHING DRY CELL BATTERY CASE OR BATTERY PACK (OPTIONAL) TO MAIN UNIT

1. Unlock the Battery Lock Button Hook as indicated in fig. a-1.
2. Put the rib of the battery pack or the case into the grooves of the main unit and attach the pack or case as indicated by the arrow.
3. Lock the Battery Lock Button Hook as indicated in fig. a-2.

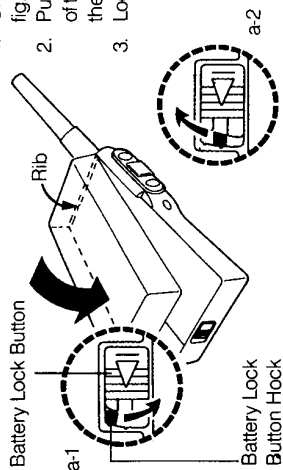

2-6 ATTACHING BELT CLIP

Attach the belt clip with the supplied screws to the back of the dry cell battery case or battery pack (optional) as the figure.

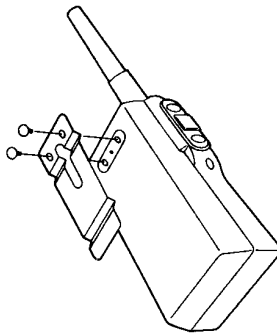

OL FUNCTIONS

OBS, AND, CONNECTOR

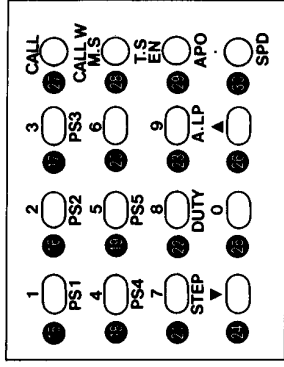
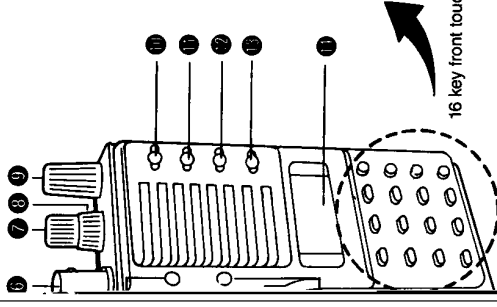

[F] Key

This key is used to access all secondary functions. Press the [F] key and hold, then press the desired command key or rotate the Dial (9), the frequency will change by 100 kHz (See 5-2(1)-1). Also this key is used to reset the unit (See 5-12 RESET).

[F1] Key

Press this [F1] key and hold, then rotate the Dial (9), the frequency will change by 1 MHz (See 5-1(2)-1 Dial Entry).

[F2] Key

Press this [F2] key and hold, then rotate the Dial (9), the frequency will change by 10 MHz (See 5-1(2)-1 Dial Entry).

Key

Press this key, the LCD (8) and the 16 key front touch pad will be lit (See 5-9(1) ON/OFF of Lamp).

Press the [F] key and hold, then press this LAMP/BEEP key, no beep will be heard even if any key is pressed (See ON/OFF OF BEEPER).

Press this key and hold to disengage squelch. Release the key to reengage squelch (See 5-1(5)-2 One Touch Squelch Deactivation Function).

Press the [F] key and hold, then press this MONI/BS key for Battery Save function (See 5-7(1) ON/OFF of Battery Save Function).

- 6 BNC Antenna Connector**
Attach a suitable antenna to this connector (See 2-1 STAN-DARD ACCESSORIES).
- 7 ON/OFF, Volume Control**
In the fully counterclockwise position, power is OFF. Rotate clockwise to turn on Power and increase audio.
- 8 Squelch Control**
When no signal is present, adjust this Squelch Control until the back ground noise just disappears (See 5-1-⑤-1) Setting Squelch Level).
- 9 Dial**
This dial is used to change frequency in VFO mode or memory channel in Memory mode.
- 10 MODE/MB Key**
Press this key to select a modulation mode (See 5-1-③-2) Modulation Mode Selection).
Press the **[F]** key and hold, then press this MODE/MB key to select a memory group (See 5-3 MEMORY).
- 11 V/M/MW Key**
Press this key, "**v**", "**v**" and "**M**" will appear alternately on the LCD. "**v**" indicates that the unit is in VFO mode and "**M**" indicates that the unit is in Memory mode.
Press the **[F]** key and hold, then press this V/M/MW key to enter a frequency and a modulation mode into a Memory channel (See 5-3-① Entering A Frequency And Its Modulation Mode Into A Memory Channel) or to shift the data in a Memory channel to VFO mode (See 5-3-③ Memory Shift Function).
- 12 SCAN/SKIP Key**
Press this key to start scanning (See 5-5 SCAN).
Press the **[F]** key and hold, then press this SCAN/SKIP key to select memory channels to be skipped while memory scanning (See 5-5-④ Memory Scan).
- 13 PRI/FL Key**
Press this key to start Priority function (See 5-6 PRIORITY FUNCTION).
Press the **[F]** key and hold, then press this PRI/FL key to activate or deactivate Functions Lock function (See 5-10 FUNCTIONS LOCK FUNCTION).
See 4-3 LCD.
- 14 LCD**
- 15 1/PS1 Key**
Press this key to enter "1".
Press the **[F]** key and hold, then press this 1/PS1 key to start the Program Scanning between the two pre-programmed frequencies (L1 and U1, Lower frequency 1 and Upper frequency 1) (See 5-5-③ Program Scan).
- 16 2/PS2 Key**
Press this key to enter "2".
Press the **[F]** key and hold, then press this 2/PS2 key to start Program Scanning between L2 and U2.
- 17 3/PS3 Key**
Press this key to enter "3".
Press the **[F]** key and hold, then press this 3/PS3 key to start the Program Scanning between L3 and U3.
- 18 4/PS4 Key**
Press this key to enter "4".
Press the **[F]** key and hold, then press this 4/PS4 key to start the Program Scanning between L4 and U4.
- 19 5/PS5 Key**
Press this key to enter "5".
Press the **[F]** key and hold, then press this 5/PS5 key to start the Program Scanning between L5 and U5.
- 20 6 Key**
Press this key to enter "6".
- 21 7/STEP Key**
Press this key to enter "7".
In VFO mode, press the **[F]** key and hold, then press this 7/STEP key to display the pre-set channel step (See 5-2 Channel Step).
- 22 8/DUTY Key**
Press this key to enter "8".
Press the **[F]** key and hold, then press this 8/DUTY key to change the receiving time and the Battery Saving time of the Battery Save function (See 5-7-② Changing the Lengths of Listening and Battery Save Mode).
- 23 9/A.LP Key**
Press this key to enter "9".
Press the **[F]** key and hold, then press this 9/A.LP key to activate or deactivate the Automatic Lamp function (See 5-9-② Automatic Lamp Function).
- 24 ▲ Key**
Press this key to increase the frequency or the Memory channel.
Also this key is used for Searching function (See 5-5-② Searching).
- 25 0 Key**
Press this key to enter "0".
Press the **[F]** key and hold, then press this 0 key to activate or deactivate the Automatic Modulation Mode Selection function (See 5-1-③-1) Automatic Modulation Mode Selection Function).
- 26 ▼ Key**
Press this key to decrease the frequency or the Memory channel.
Also this key is used for Searching function (See 5-5-② Searching).

27 CALL/CALL W Key

Press this key to retrieve Call channel (See 5-4-2) Retrieving the Call Channel).
Press the [F] key and hold in VFO mode, then press this CALL/CALL W key to enter the frequency and the mode into the Call channel (See 5-4-1 Entering A Frequency And Its Modulation Mode Into Call Channel).

28 M.S/T.S Key

Press this key to start the Mode Select scanning (See 5-5-6 Mode Select Scan).
Press the [F] key and hold, then press this M.S/T.S key to select the Timed scanning (See 5-5-6 Timed Scan).

29 EN/APO Key

Press this key after number keys are pressed to complete direct frequency entry (See 5-1-2-3) key Pad Direct Entry).
Press the [F] key and hold, then press this EN/APO key, Automatic Power Off function will be activated (See 5-8 AUTOMATIC POWER OFF FUNCTION).

30 ./SPO Key

Press this key to enter "." (decimal point) when a frequency is entered directly with the number keys (See 5-1-2-3 Key Pad Direct Entry).
Press the [F] key and hold, then press this ./SPO key to select a desired scanning speed (See 5-5-7 Scanning Speed).

4-2 JACKS

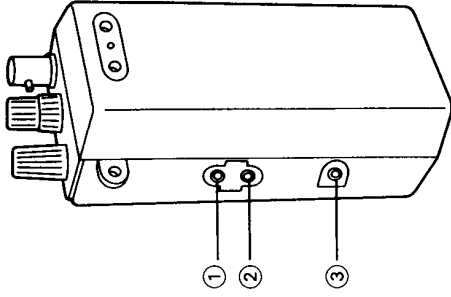

1 Speaker Jack

This jack is for an External Speaker.
Audio volume can be controlled by the volume control knob.

2 Line Out Jack

This jack is for recording.
Audio volume can be controlled by the volume control knob.

3 DC IN Jack

This jack is for accessing the outside power source. ALINCO's optional accessories (EDC-36, EDC-37, or EDC-43) are recommended.

4-3 LCD PANEL

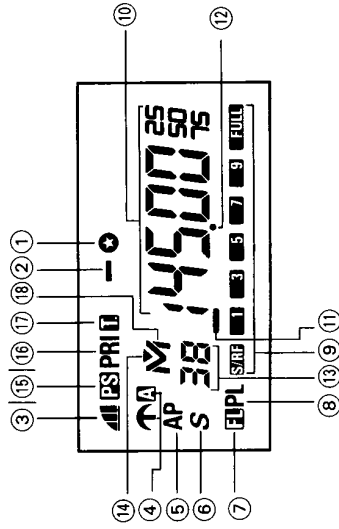

① **BS (Battery Save) Indicator**

The " **B** " will appear when Battery Save function is activated (See 5-7-① ON/OFF of Battery Save Function).

② **Battery Saving Time Indicator**

While Battery Save function is activated, the " **—** " will appear when the combination of 400m second receiving and 600m second battery saving is selected (See 5-7-② Changing the Lengths of Listening and Battery Save Mode).

③ **Scanning Speed Indicator**

Scanning speed is indicated by 3 bars.

..... 10 channels/second

..... 15 channels/second

..... 20 channels/second

(See 5-5-⑦ Scanning Speed).

④ **Modulation Mode Indicator**

" **A** " will appear when a signal is received in AM mode. " **M** " will appear when a signal is received in Narrow FM mode. Both " **M** " and " **A** " will appear when a signal is received in Wide FM mode (See 5-1-③-2) Modulation Mode Selection).

⑤ **AP (Automatic Power Off) Indicator**

The " **AP** " will appear when Automatic Power Off function is activated (See 5-8 AUTOMATIC POWER OFF FUNCTION).

⑥ **Memory Skip Indicator**

When this " **S** " appears in Memory mode, the channel will be skipped while memory scanning (See 5-5-④ Memory Scan).

⑦ **FL (Functions Lock) Indicator**

The " **FL** " will appear when Functions Lock function is activated (See 5-10 Functions Lock Function).

⑧ **PL (Automatic Lamp Function) Indicator**

The " **PL** " will appear when Automatic Lamp function is activated (See 5-9-② Automatic Lamp Function).

⑨ **S/RF (Signal/Radio Frequency) Indicator**

The " **S/RF** " will appear when a signal is received and the bars indicate the received signal strength.

⑩ **Frequency**

Receive frequencies and channel steps are displayed in this area.

⑪ **+ 1000 MHz Indicator**

The " **—** " will appear when the frequency is the one displayed in the area of ⑩ + 1000 MHz.
Example: **-145.00 - 1145 MHz**

⑫ **Frequency Decimal Point**

When a receive or channel step frequency is displayed, the decimal point divides MHz and 0.1 MHz. While scanning, the decimal point flashes.

⑬ **Memory Channel Number**

The figure indicates the memory channel number. When the Call channel is activated, the memory channel Number will be replaced by " **L** ".

⑭ **Memory Group Indicator**

When the " **▼** " appears, the memory group is sub-group or scanning group (See 5-3 MEMORY).

⑮ **PS (Program Scan) Indicator**

The " **PS** " will appear while program scanning is selected (See 5-5-③ Program Scan).

⑯ **PRI (Priority) Indicator**

The " **PRI** " will appear when priority function is activated (See 5-6 PRIORITY FUNCTION).

⑰ **Timed Scan Indicator**

The " **T** " will appear while timed scanning is selected (See 5-5-④ Timed Scan).

⑱ **V/M (VFO/Memory), Receiving Mode Indicator**

The " **▼** " will appear when the unit is in VFO mode. The " **M** " will appear when the unit is in Memory mode (See 5-1-① Operational Mode).

5. OPERATION

5-1 RECEIVING

To receive a signal, its frequency and appropriate modulation mode should be selected. The signal can not be received clearly without selecting them correctly. As the unit has Automatic Modulation Mode Selection function, appropriate modulation mode is selected automatically in often-used frequency bands (See 5-1-3-1) Automatic Modulation Mode Selection Function).

① Operational Modes



VFO Mode



Memory Mode



Call Channel Mode

The unit has three operational modes, VFO mode, Memory mode, and Call Channel mode. The right mode should be selected for each operation.

- 1) **VFO mode**
Press the VFO key so that "V" appears on the LCD, the unit will be in VFO mode.
In VFO mode, the frequency can be changed continuously.
- 2) **Memory mode**
Press the MEM key so that "M" appears on the LCD, the unit will be in Memory mode. Memory function memories data in memory channels and retrieve the data.
In Memory mode, a desired memory channel can be retrieved.

③ Call Channel mode

Call Channel is a kind of memory channel and it can be retrieved at a touch. Press the CALL key, "C" will appear on the LCD, the unit will be in Call Channel mode, and Call Channel will be retrieved.

② Frequency Selection

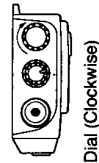
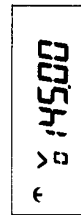

Dial (Clockwise)

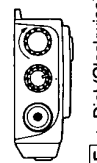
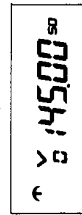

[F] + Dial (Clockwise)

There are three ways to enter frequency, with the dial, with the DIAL key and the DIAL key, and the direct entry with the number keys.

- 1) **Dial Entry**
 1. Rotating the tuning dial clockwise increases the frequency one channel step (See 5-2 CHANNEL STEP) for each click. Counterclockwise rotation decreases the frequency one channel step for each click.
 2. Press the [F] key and hold, then rotate the tuning dial clockwise/counterclockwise, the frequency will increase/decrease by 100 kHz irrespective of the channel step.
 3. Press the [F1] key and hold, then rotate the tuning dial clockwise/counterclockwise, the frequency will increase/decrease by 1 MHz.
 4. Press the [F2] key and hold, then rotate the tuning dial clockwise/counterclockwise, the frequency will increase/decrease by 10 MHz.

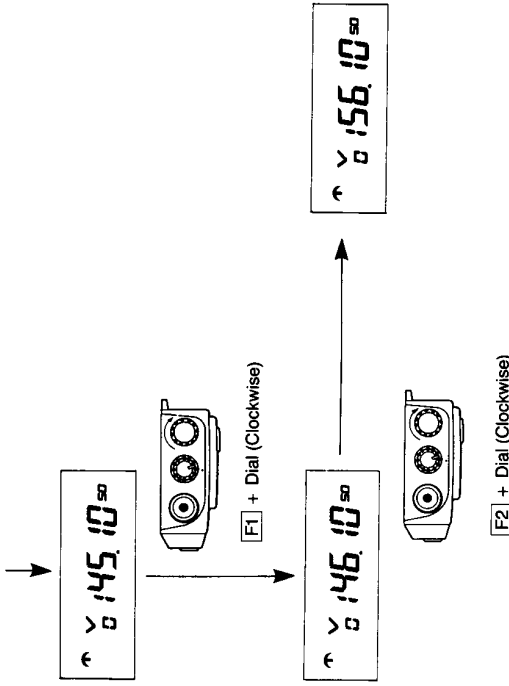

2) UP/DOWN Key Entry

1. Press the UP key, the frequency will increase by the channel step.
2. Press the DOWN key, the frequency will decrease by the channel step.

Note: If the UP key or the DOWN key is pressed and held for about a second, searching function will be started (See 5-5-2 Searching). If the UP / DOWN key is pressed and held for two seconds or longer, the frequency will continue to increase/decrease until the key is released.

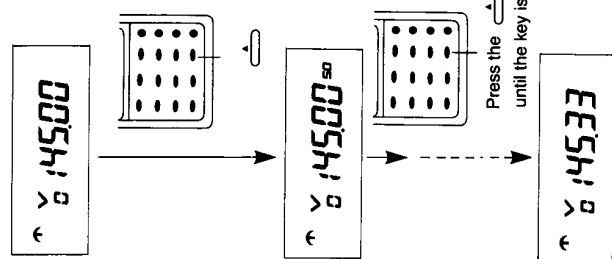

3) Key Pad Direct Entry

Frequencies can be entered by the number keys (0 ~ 9 and the decimal point).

1. Press the number key(s) of a desired frequency.
2. Press the EN_{APO} key.

Example:

400 MHz
Press the PS4 key, the EN_{APO} key (twice), and the EN_{APO} key.

145.12 MHz

Press the PS1 key, the PS4 key, the PS2 key, the PS5 key, the PS1 key, the PS2 key, the PS1 key, the PS2 key, and the EN_{APO} key.

3. Press the EN_{APO} key and the SP0 key first, to enter a frequency less than 1 MHz.

Example:

500 kHz

Press the EN_{APO} key, the SP0 key, the PS5 key, the EN_{APO} key (twice), and the EN_{APO} key.

4. While entering a frequency, press the E key, the entering will be cancelled.

- Note:** • When a frequency of 10 MHz or over is entered, 5 kHz can not be entered.

Example: 15.235 MHz (The channel step = 5 kHz)

Press the PS1 key, the PS2 key, the PS5 key, the PS2 key, the PS3 key, the PS2 key, the EN_{APO} key, and the EN_{APO} key.

15.23 MHz will be entered. Then rotate the dial clockwise for one click or press the EN_{APO} key, the frequency will be 15.235 MHz.

- When the entered frequency does not fit the channel step, the frequency may be changed to fit the channel step.

③ Modulation Mode

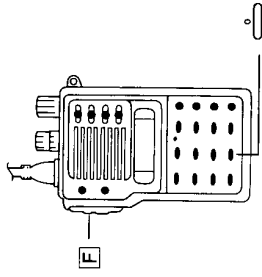

1) Automatic Modulation Mode Selection Function

When a desired frequency is selected in VFO mode, its appropriate modulation mode will be selected automatically by this function.

The function can be de-activated.

1. Press the E key and hold, then press the EN_{APO} key, the function will be de-activated.
2. Press the E key and hold, then press the EN_{APO} key again, the function will be activated.

Modulation Mode Selected By the Function

0.100 MHz ~	29.995 MHz: AM
30.000 MHz ~	75.995 MHz: NFM
76.000 MHz ~	89.995 MHz: WFM
90.000 MHz ~	107.995 MHz: NFM
108.000 MHz ~	137.995 MHz: AM
138.000 MHz ~	1299.995 MHz: NFM

Note: • At initial factory setting and after reset, the function is activated.

- If the modulation mode of a frequency in your area (country) does not fit the above chart, the function should be deactivated and the right mode should be selected.

2) Modulation Mode Selection

Press the MODE_{MB} key, the modulation mode will be changed. Each time the MODE_{MB} key is pressed the mode will cycle through AM, NFM, and WFM as the chart.

" A " appears in AM mode.

" N " appears in NFM mode.

Both " A " and " N " appear in WFM mode.

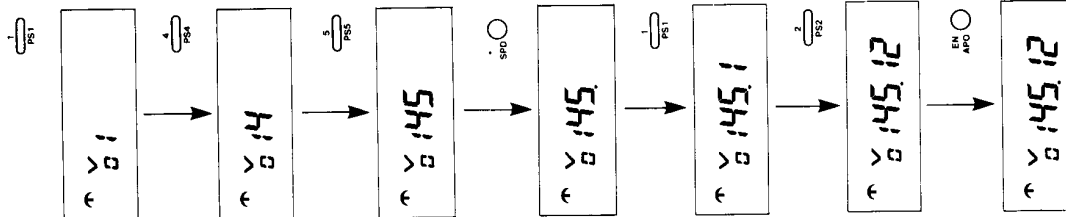
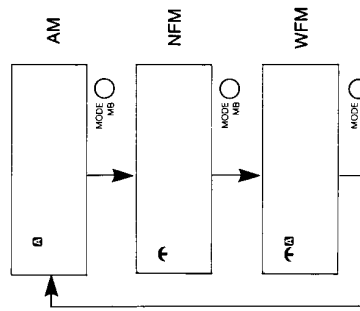

④ Volume Control

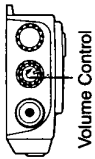

Rotate the volume control clockwise to increase audio to a desired level.

⑤ Squelch

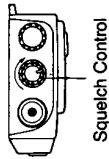

While receiving in NFM or WFM and no signal is received, noise is heard. By squelch function the noise ceases.

1) Setting Squelch Level

1. In NFM select a frequency at which no signal is received.
2. Rotate the squelch control clockwise until the noise just disappears.

Note: Squelch level may change depending on the modulation mode.

2) One Touch Squelch Deactivation Function

Press and hold the **MON** **BS** key to override squelch. While the **MON** **BS** key is pressed, weak signals below the squelch threshold may be heard. Release the **MON** **BS** key to activate squelch again.

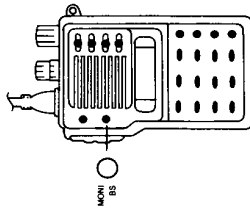

5-2 CHANNEL STEP

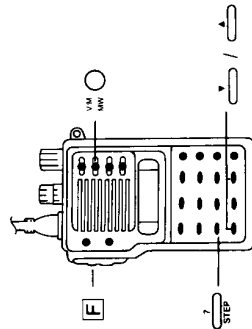

Channel Step Selection

1. Set the unit in VFO mode.
2. Press the **F** key and hold, then press the **STEP** key, the programmed step will be displayed on the LCD.
3. Rotate the dial or press the **MON** **BS** key or the **MON** **BS** key so that the desired step appears on the LCD.
4. Press the **MON** **BS** key, the frequency will appear on the LCD.

Note: ● If the channel step is changed to 12.5 kHz from the other steps or to the others from 12.5 kHz, the programmed frequency may be changed.

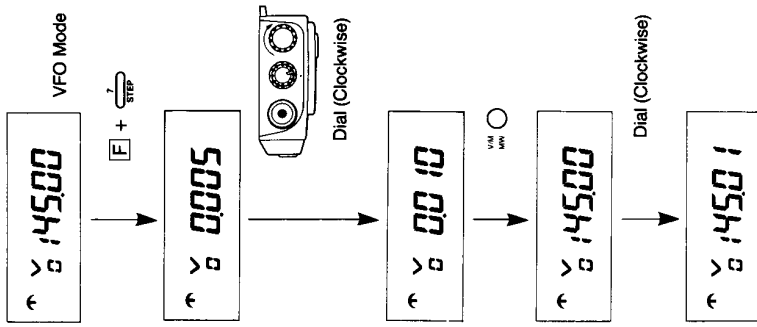

5-3 MEMORY

By this function, often-used frequencies of interest and their appropriate modulation modes can be memorized in the memory channels and retrieved.

The unit has 100 memory channels in total. They are divided into three groups, the main group, the sub group, and the scanning group. The main group has 40 channels (Channel 0 ~ Channel 39). The sub group also has 40 channels (Channel 0 ~ Channel 39). The scanning group has 20 channels (Channel 0 ~ Channel 9, Channel L1 ~ Channel L5, and Channel U1 ~ Channel U5) and they are used for scanning (See 5-5-③ Program Scan and 5-5-⑥ Memorizing Signal-Received Frequencies).

To enter a frequency and its modulation mode into a memory channel or retrieve a desired memory channel, the group should be selected first then the channel should be selected.

1 Entering A Frequency And Its Modulation Mode Into A Memory Channel

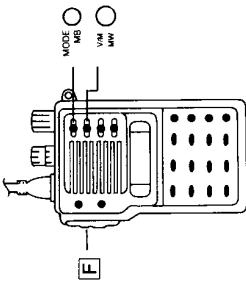

1. Set the unit in VFO mode.
2. Select a desired frequency and its modulation mode to be memorized.
3. Press the [F] key and hold, then press the MODE/MR key to select a desired group. Pressing the [F] key, each time the MODE/MR key is pressed, the group will rotate as chart.

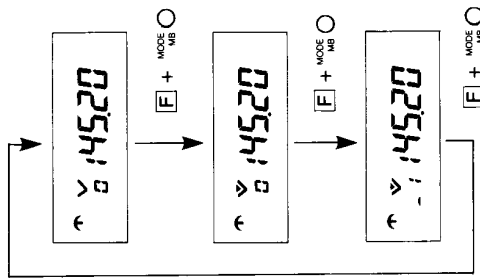

Main Group: Only "v" appears.

Sub Group: "v" and "v" appear.

Scanning Group: "v", "v", and "v" or "L" or "U" appear.

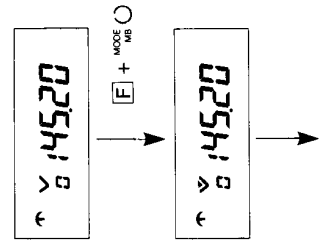

4. Press the [F] key and hold, then press the key (to increase the memory channel No.) or the key (to decrease the memory channel No.) to select a desired memory channel No. Pressing the [F] key each time the key / key is pressed, the memory channel No. will rotate as the charts.



Main and Sub Group

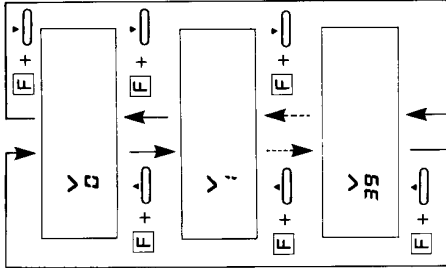

Scanning Group

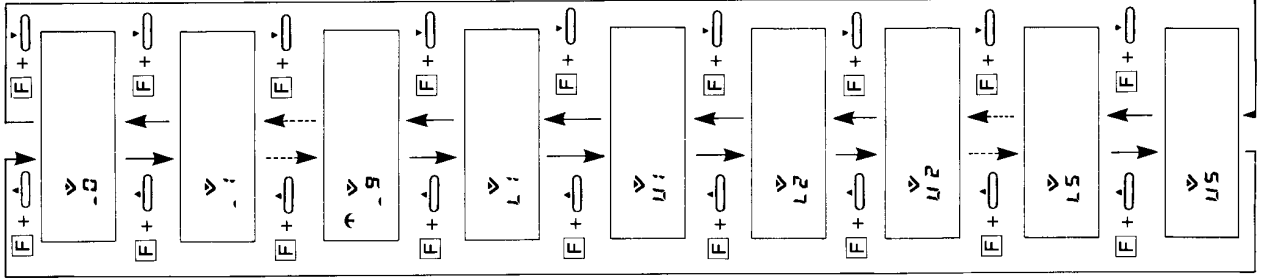

② Retrieving A Memory Channel

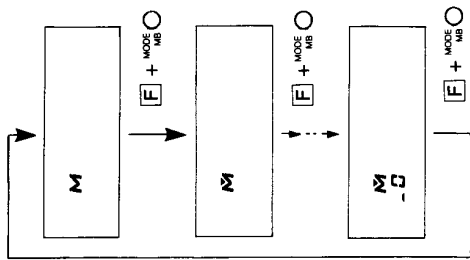

5. Press the **F** key and hold, then press the **MODE MB** key. The entering will be completed.

1. Press the **MODE MB** key to set the unit in Memory mode.

2. Press the **F** key and hold press the **MODE MB** key to select a desired group.

Pressing the **F** key, each time the **MODE MB** key is pressed, the group will rotate as the chart.

Main Group: Only "M" appears.

Sub Group: "M" and "▼" appear.

Scanning Group: "M", "▼", and "—" or "L" or "U" appear.

3. Rotate the dial or press the **↻** key or the **↺** key to select a desired memory channel No. to be retrieved. Rotating the dial clockwise or pressing the **↻** key will increase the channel No., and rotating the dial counterclockwise or pressing the **↺** key will decrease the channel No. as the chart.

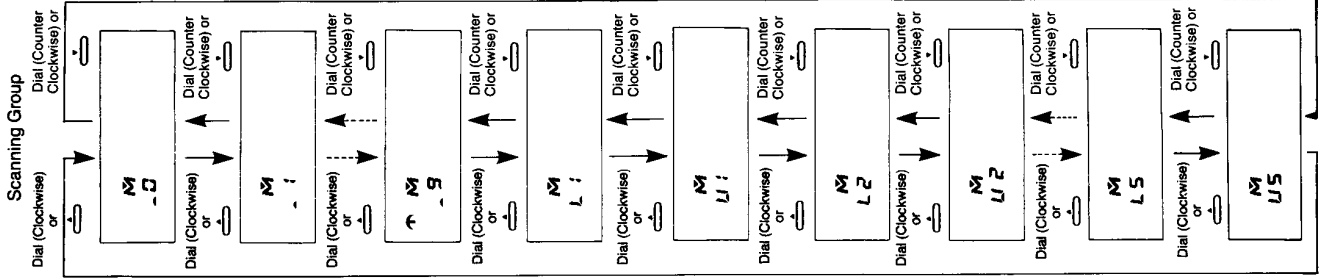
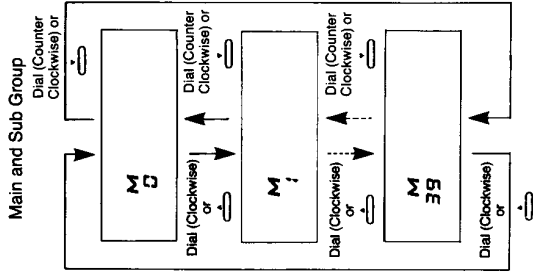

- The frequency and the modulation mode memorized in the channel will appear on the LCD and the retrieving will be completed.

③ Memory Shift Function

- By this function, the frequency and the modulation mode memorized in memory channels can be copied to VFO mode.
- In Memory mode select a desired memory channel No. of which the frequency and the modulation mode to be copied.
 - Press the **[F]** key and hold, then press the **[MEM]** key, the frequency and the modulation mode will be copied to VFO mode.
 - Press the **[MEM]** key, the unit will be in VFO mode.

5-4 CALL CHANNEL

In addition to the 100 memory channels, the unit has one Call channel. Call channel is a kind of memory channel. A frequency and its modulation can be memorized in the call channel. As the Call channel can be retrieved at a touch, the most often-used frequency and its modulation mode of interest are usually memorized in the Call channel.

① Entering A Frequency And Its Modulation Mode Into Call Channel

- Set the unit in VFO mode.
- Select a desired frequency and its modulation mode to be memorized.
- Press the **[F]** key and hold, then press the **[CALL W]** key. The frequency and the modulation mode will be memorized in the Call channel.

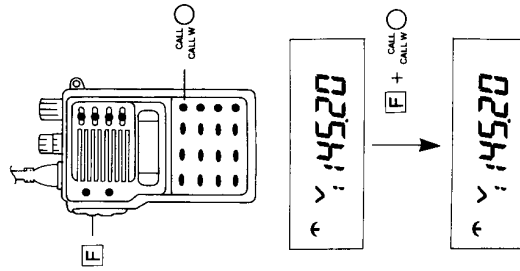

② Retrieving The Call Channel

- In either VFO mode or Memory mode, press the **[CALL W]** key, the Call channel will be retrieved and "CALL W" will appear instead of number. The frequency and the modulation mode indicator(s) memorized in the Call channel will also appear on the LCD.
- When the Call channel is retrieved from VFO mode, press the **[CALL W]** key again, the unit will return to VFO mode.
- When the Call channel is retrieved from Memory mode, press the **[CALL W]** key again, the unit will return to Memory mode.

5-5 SCAN

This function is used to find a frequency or to listen to some frequencies continuously.

The unit has the following five scanings basically.

- In VFO mode { ① VFO Scan
② Searching
③ Program Scan
- In Memory mode { ④ Memory Scan
⑤ Mode Select Scan

In Memory Scan, desired memory channels to be skipped can be set in addition to scanning of all memory channel.

Three scanning speeds are available for all five scanning.

Timed scanning (See 5-5-⑥ Timed Scan) is available for VFO Scan, Program Scan, Memory Scan, and Mode Select Scan.

This function scans all frequencies by the pre-set channel step from 0.100 MHz to 1299.995 MHz in VFO mode.

- Set the unit in VFO mode.
- Select a scanning direction by the dial or the **[<]** / **[>]** key.
- Press the **[SCAN SWP]** key, the decimal point will flash and the scanning will start.
- While scanning, the direction can be changed by the dial or the **[<]** / **[>]** key.
- While scanning, press the **[SCAN SWP]** key again, the scanning will stop.
- While scanning and automatic modulation mode selection function activating, the mode and the channel step will be changed automatically.
- While scanning, if a signal is received at a frequency, the scanning will pause. Two seconds after the signal ceases, the scanning will resume.

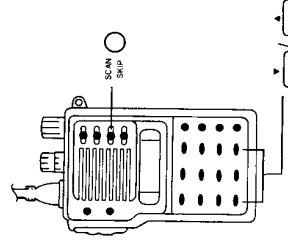

① VFO Scan

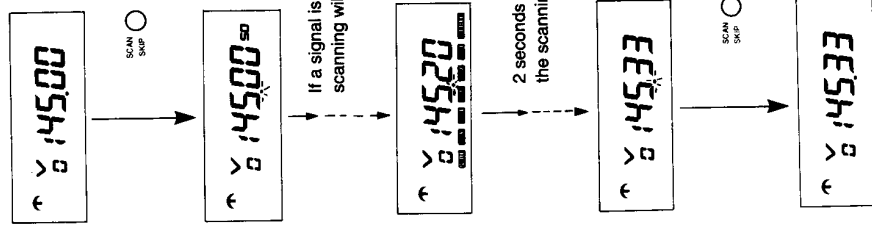

② Searching

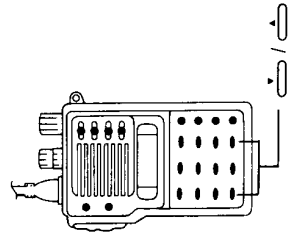

- This function is similar to VFO Scan and searches all frequencies in VFO mode. However, if a signal is received while searching, the searching will stop and not resume.
1. Set the unit in VFO mode.
 2. Press and hold the \leftarrow key or the \rightarrow key according to the desired direction for approximately one second. Searching will start.
 3. If a signal is received while searching, searching will stop at the frequency.
 4. If the \leftarrow / \rightarrow key is pressed and held for two seconds or longer, the frequency will continue to change until the key is released.
 5. While searching, the direction can be changed by the dial.

③ Program Scan

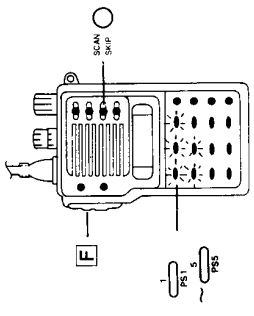

Select a desired lower limit frequency.

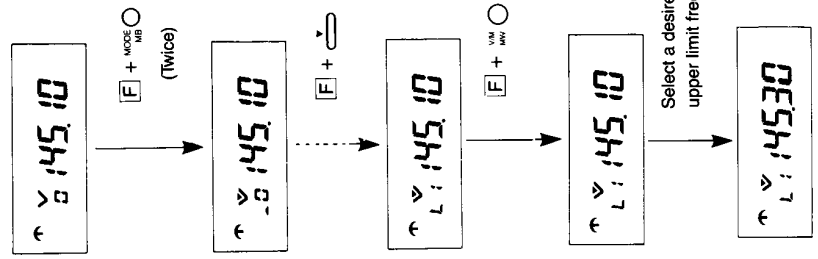

6. While searching, press the \leftarrow / \rightarrow key, the searching will stop.
- This function scans frequencies by the channel step between two programmed memory channels (L1 and U1, L2 and U2, ... L5 and U5).
1. Enter frequencies into memory channels L1, U1, L2, U2, ... L5, and U5).
 2. Set the unit in VFO mode.
 3. Select a desired direction by the dial or the \leftarrow / \rightarrow key.
 4. Press and hold the $\left[\text{F}\right]$ key, then press the \leftarrow / \rightarrow key, scanning between the two frequencies of Channel L1 and U1/L2 and U2/ ... L5 and U5 will start.
 5. While scanning, press the $\left[\text{SCAN SKIP}\right]$ key, or the $\left[\text{V}\right]$ / $\left[\text{L}\right]$ key, or the $\left[\text{PS1}\right]$ - $\left[\text{PS5}\right]$ key, the scanning will stop.
 6. While scanning, the direction can be changed by the dial or the \leftarrow / \rightarrow key.
 7. If a signal is received while scanning, the scanning will pause at the frequency. Two seconds after the signal ceases, the scanning will resume.
- Note:** When Program Scanning is started at a frequency out of its range, the scanning will start at the frequency of the channel L or U.

④ Memory Scan

This function scans the frequencies memorized in the memory channels within the memory group.

1. Set the unit in Memory mode.
2. Select a desired direction by the dial or the / key.
3. Press the key, the scanning will start.
4. While scanning, press the key again, the scanning will stop.
5. While scanning, the direction can be changed by the dial or the / key.
6. If a signal is received while scanning, the scanning will pause at the frequency. Two seconds after the signal ceases, the scanning will resume.

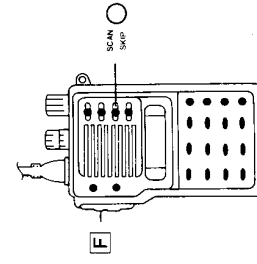
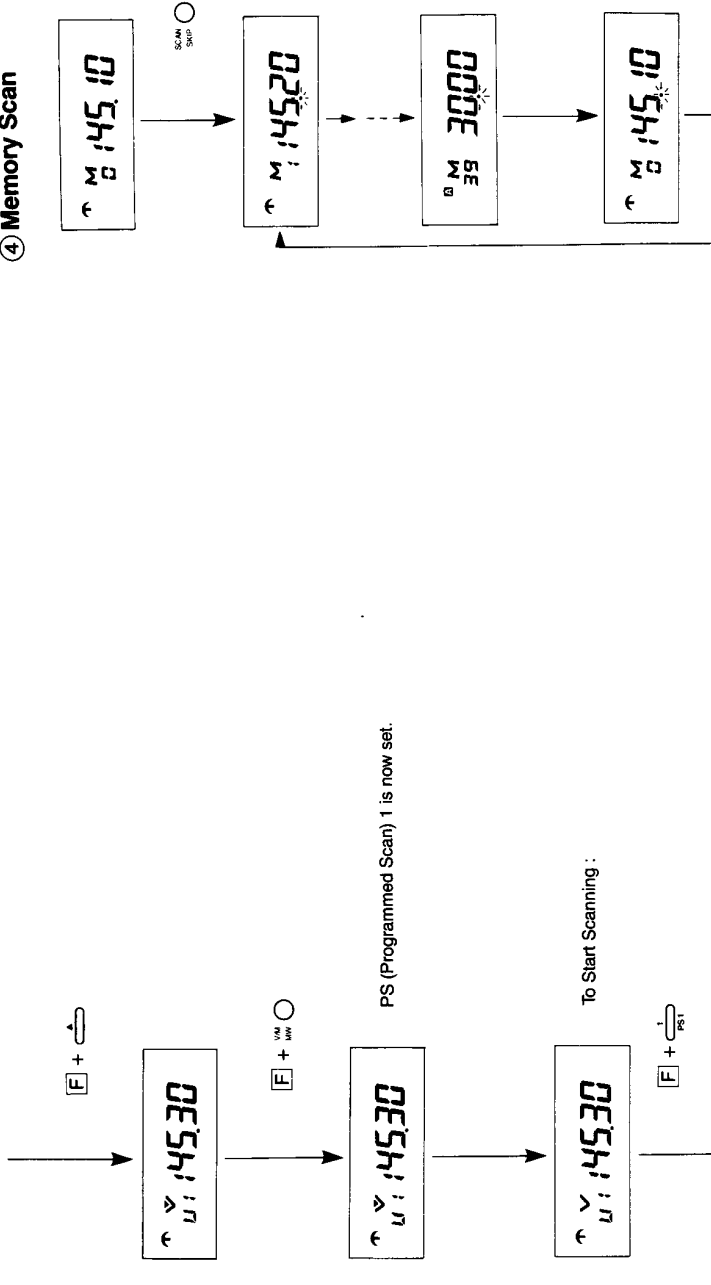

Memory Skip Indicator

While Memory scanning, desired pre-programmed channel(s) can be skipped.

1. In Memory mode, select a channel to be skipped.
2. Press the key and hold, then press the key, "S" will appear on the LCD. While Memory scanning, the memory channel will be skipped.
3. Repeat 1. and 2. to set more channels to be skipped.
4. Retrieve a memory channel to be skipped. Press and hold the key, then press the key, "S" will disappear.

The channel will not be skipped while Memory scanning.

⑤ Mode Select Scan

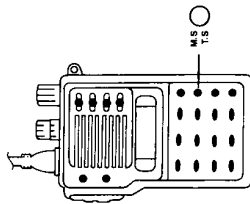

This function scans memory channels in which the same modulation mode as the starting channel are programmed within the group.

1. Set the unit in Memory mode.
2. Select a desired direction by the dial or the / key.
3. Press the key, the scanning will start.
4. While scanning, press the key, the scanning will stop.
5. While scanning, the direction can be changed by the dial or the / key.
6. If a signal is received while scanning, the scanning will pause at the frequency. Two seconds after the signal ceases, the scanning will resume.

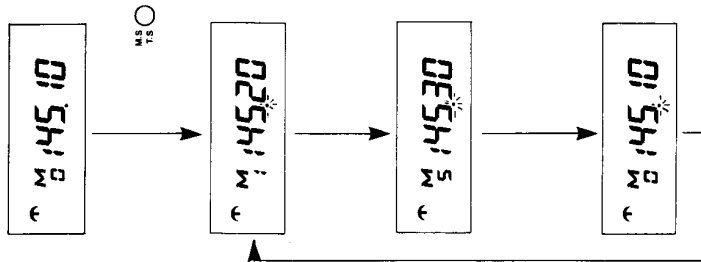

⑥ Timed Scan

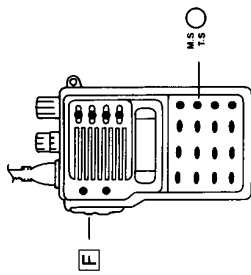

In VFO Scanning, Program Scanning, Memory Scanning, and Mode Select Scanning, if a signal is received, the scanning will pause and two seconds after the signal ceases the scanning will resume.

While Time Scan function is activating in the above scanings, if a signal is received, the scanning will pause and after five seconds the scanning will resume irrespective of the signal condition.

1. Press the key and hold, then press the key. " " will appear on the LCD and Timed Scan function will be activated.
2. Press the key and hold, then press the key again. " " will disappear and Timed Scan function will be de-activated.



Note: At initial factory setting and after reset, Timed Scan is activated.

⑦ Scanning Speed

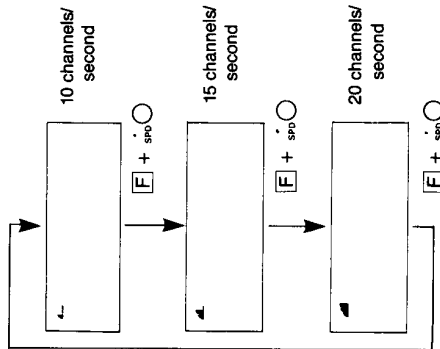
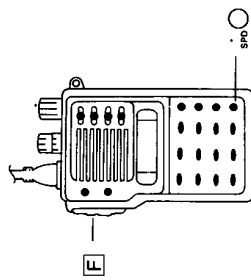

All scanning functions scan 10 channels or 10 frequencies per seconds. The scanning speed can be changed to 15 or 20 channels or frequencies per second.

Press the key and hold, then press the key. Each time the key is pressed, the speed will cycle as the chart.

Note: When the speed of 15 or 20 channels/frequencies per second selected, weak signals may not be received.

⑧ Memorizing Signal-Received Frequencies



— 0 ~ 9

If a signal is received while scanning, the scanning will stop or pause at the frequency and the frequency will be memorized in memory channel automatically.

The frequencies are memorized in channel_0 to channel_9 in turn. Then, they are memorized in channel_0 to channel_9 in turn again. When a frequency is memorized, pre-memorized one is cancelled.

5-6 PRIORITY FUNCTION

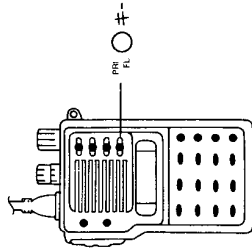

By this function, two different frequencies (one in VFO mode and other in a memory channel) are received alternately. The unit has two priority functions (VFO priority and Memory priority).

② Memory Priority

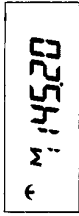

5 seconds

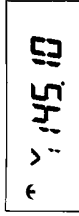

1 second

This function is the reverse of VFO priority. A memory frequency is received for five seconds and a VFO frequency is received for one second in a continuous cycle.

1. Set the unit in VFO mode. Select a desired frequency (and a modulation if needed) to receive in VFO mode.
2. Press the \overline{M} key to set the unit in Memory mode.
3. Select a desired memory channel to receive.
4. Press the \overline{PR} key. Memory priority function will be activated.
5. If a signal is received at the VFO frequency, it will be received for five seconds. After five seconds, the Memory frequency will be received irrespective of the signal condition.
6. While the Memory function activating, press the \overline{PR} key, the function will be de-activated and the unit will be in Memory mode.

5-7 BATTERY SAVE FUNCTION

This function reduces unnecessary battery drain by alternating between listening and the Battery Save Mode. If there is no operation and no signal is received for about five seconds, the function will repeat the following cycle continuously.

- 1) Listen for a signal for about 200 mS.
- 2) Battery Save for about 800 mS.

① VFO Priority

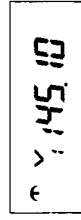

5 seconds

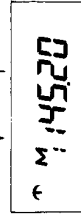

1 second

By this function, a VFO frequency is received for five seconds and a Memory frequency is received for one second in a continuous cycle.

1. Press the \overline{M} key to set the unit in Memory mode.
2. By the dial or the \overline{D} / \overline{F} key, select a desired memory channel to receive.
3. Press the \overline{M} key to set the unit in VFO mode.
4. Select a desired frequency (and the modulation mode if needed) to receive in VFO mode.
5. Press the \overline{PR} key. VFO priority function will be activated.
6. If a signal is received at the frequency in the memory channel, it will be received for five seconds. After five seconds, the VFO frequency will be received irrespective of the signal condition.
7. While the VFO priority function activating, press the \overline{PR} key, the function will be de-activated and the unit will be in VFO mode.

① ON/OFF of Battery Save Function

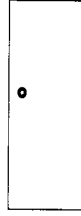
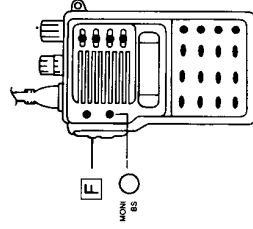

BS (Battery Save) Indicator

1. Press the \overline{F} key and hold, then press the $\overline{MON BS}$ key. " " will appear on the LCD and the function will be activated.
2. Press the \overline{F} key and hold, then press the $\overline{MON BS}$ key again. " " will disappear and the function will be de-activated.

② Changing the Lengths of Listening and Battery Save Mode

1. Press the [F] key and hold, then press the $\frac{LAMP}{BEEP}$ key. " _ " will appear by " _ " on the LCD and the cycle will be the following.
 - 1) Listen for a signal for about 400 mS.
 - 2) Battery Save for about 600 mS.
2. Press the [F] key and hold, the press the $\frac{LAMP}{BEEP}$ key again. " _ " will disappear, and the cycle will be original one.

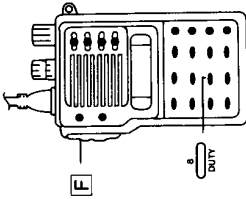

Battery Saving Time Indicator



5-9 LAMP ON/OFF of Lamp

1. Press the $\frac{LAMP}{BEEP}$ key, the LCD and the 16 keys on the front touch pad will be illuminated.
2. After five seconds, the lights will go out automatically.
3. While the lights are on, press the $\frac{LAMP}{BEEP}$ key, the lights will go out.

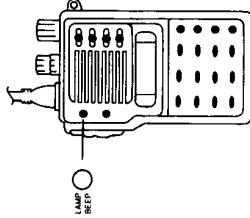

5-8 AUTOMATIC POWER OFF FUNCTION

This function prevents inadvertent waste of battery power when the radio is left ON unintentionally for about 30 minutes.

1. Press the [F] key and hold, then press the $\frac{AP}{O}$ key. " AP " will appear on the LCD and the function will be activated.
2. If no signal is received and there is no operation for about 30 minutes, the unit will pause.
3. After the unit pauses, rotate the dial or turn off the power and turn on the power again to release the pausing.
4. While the function activating, press the [F] key and hold, then press the $\frac{AP}{O}$ key. " AP " will disappear and the function will be de-activated.

Note: Even while the unit is pausing by the function, it consumes the battery power. Turn off the power when the unit is not used.

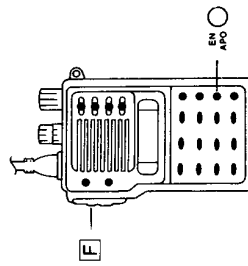

AP (Automatic Power Off) Indicator



② Automatic Lamp Function

While this function is activated if any key is pressed, the lights will be on.

1. Press the [F] key and hold, then press the $\frac{PL}{A.L.P}$ key. " PL " will appear on the LCD and the function will be activated.
2. If any key is pressed, the lights will be on for five seconds.
3. While the function is activated, press the [F] key and hold, then press the $\frac{PL}{A.L.P}$ key. " PL " will disappear and the function will be released.

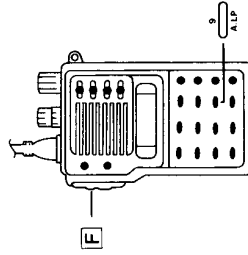

PL (Automatic Lamp Function) Indicator



5-10 FUNCTIONS LOCK FUNCTION

This function prevents wrong operations while waiting for receiving a signal.

1. Press the **[F]** key and hold, then press the **PR FL** key. The Functions Lock indicator "FL" will appear on the LCD and the function is activated.
2. While the function is activated, only three functions (Release of the Functions Lock, Lamp function, and One Touch Squelch De-activation function) can be activated.
3. While the function is activated, press the **[F]** key and hold, then press the **PR FL** key. The Functions Lock will be released.

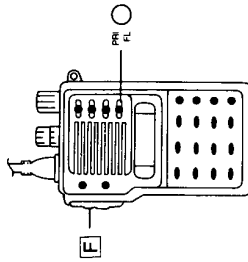

FL (Functions Lock) Indicator



5-11 ON/OFF OF BEEPER

When any key is pressed or the digits of 100 kHz, 10 kHz and 1 kHz become 000 or 500, a beep will be heard. The beeper can be de-activated.

1. Press the **[F]** key and hold, then press the **LAMP BEEP** key, no beep will be heard.
2. Press the **[F]** key and hold, then press the **LAMP BEEP** key again, beeper will work.

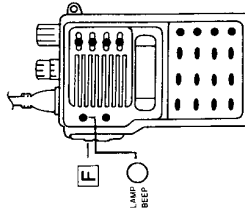

5-12 RESET

With the power off, press and hold the **[F]** key, then turn on the power. The unit will reset to initial factory setting as follows:

Operational Mode: VFO Mode
 Frequency: 145.000 MHz
 Memory Group: Main Group
 Memory Channel: Channel 0
 Scan: Timed Scan
 Automatic Modulation Mode
 Selection Function:

ON Channel Steps and Modulation Modes	
0.100MHz~	0.520MHz : 5kHz AM
0.522MHz~	1.629MHz : 9kHz AM
1.630MHz~	29.995MHz : 5kHz AM
30.000MHz~	75.995MHz : 5kHz NFM
76.000MHz~	89.995MHz : 50kHz WFM
90.000MHz~	107.995MHz : 5kHz NFM
108.000MHz~	137.995MHz : 5kHz AM
138.000MHz~	1299.995MHz : 5kHz NFM