

ALINCO

VHF/UHF FM MOBILE TRANSCEIVER

DR-570T/E

INSTRUCTION MANUAL

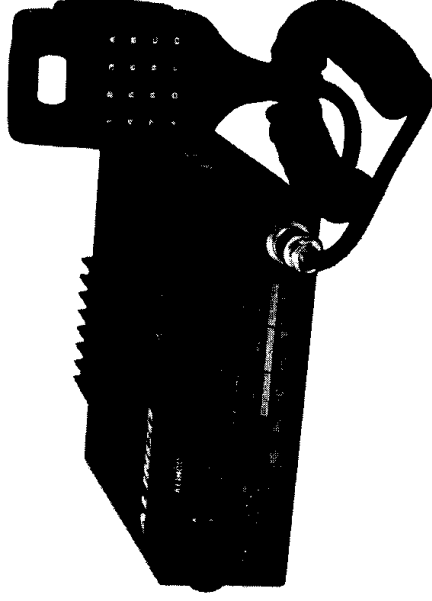

DR-570T

ALINCO ELECTRONICS INC.

20705 S. Western Ave., Suite 104, Torrance Ca. 90501, U.S.A.
Phone: (213) 618-8616

1-1-1 Mishimae, Takatsuki city, Osaka 569, Japan

ALINCO ELECTRONICS INC.

TABLE OF CONTENTS

1. Accessories	2
2. Introduction	3
3. Operation	4
Controls and Functions	4
Functions	11
Receive	18
Transmit	21
Master Reset	24
4. Installation	25
5. Specifications	26

1. ACCESSORIES

Carefully unpack your transceiver and you will find the following accessories included with the transceiver.

● Microphone	x1
● D. C. Power Cord	x1
● Space fuse (15A)	x2
● Installing angle joint	x1
● M5x20 mm Screw	x4
● M5x20 mm Mounting Screw	x4
● M5 Nut	x4
● M5 Flat Washer	x4
● M5 Spring Washer	x4
● Screws for Bracket	x4

INTRODUCTION

The ALINCO Model DR-570T/E is a dual band transceiver offering big value in a small package. The independent main band and sub-band operation permits full duplex operation, offers 20 memory channels (10 per band), high/low power, four scanning functions, full reverse operation at a touch, priority, call and ABX functions. The 37 selectable sub-audible encode tone frequencies can be called for encode or encode/decode (tone squelch CTCSS) thus permitting private access usage. The front panel is easy to read and understand. The LCD lets the operator know at a glance which functions are in operation. The built in duplexer has a single antenna output for a dual band antenna. Beep and bell tones can be added or deleted as desired. ALINCO has listened to the consumer and in response has created the versatile 570T/E which is truly user friendly with minimal effort. We hope you will enjoy many happy operating hours with the 570T/E.

3. OPERATION

3-1. CONTROLS AND FUNCTIONS

3-1-1. Front Panel

The primary functions of the ALINCO DR-570T/E are printed in white on the face of the transceiver. Many of the function keys offer two separate functions. In such cases, the secondary function is printed in amber. To access the secondary functions, first press the FUNCTION key, (the 'F' indicator will light on the display) then the desired function key. In this manual, the primary functions keys appear in all capital letters; the secondary function keys appear in all capital letters within parenthesis. Indicator lights, as they appear on the display are all capital with a single quote (').

The DR-570T/E controls and indicators are as follows:

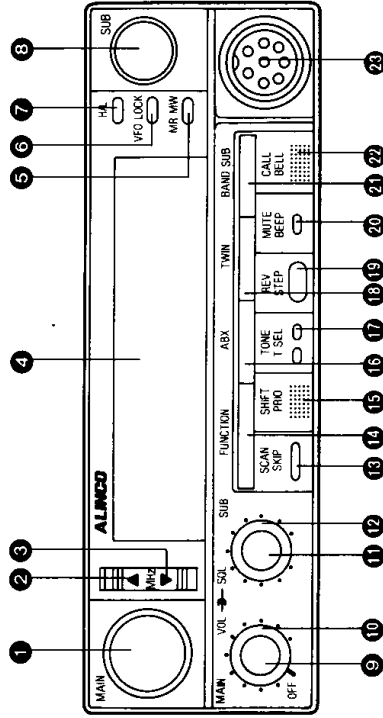

1 Main Band Dial

The main band dial is rotated either clockwise or counterclockwise to select the transmit/receive frequencies, memory channels, frequency steps, sub-audible encode tone frequencies and frequency shifts (offsets).

2 MHz UP Key

Utilized only in the VFO mode, the MHz UP key increments the VFO frequency one MHz each time it is pressed. If the key is pressed and held, the frequency will increment one MHz in rapid succession.

3 MHz DOWN Key

Utilized only in the VFO mode, the MHz DOWN key operates essentially the same as the MHz UP key (No. 2, above), but the frequency decrements one MHz.

4 LCD Panel

The LCD panel shows functional information during transceiver operation. Refer to Section 3-1-2 for information on each indicator light.

5 MR (MW) Key

The MR key accesses the memory mode in which preselected frequencies, shifts, and sub-audible encode tones can be recalled (after being programmed). To programme the memory channels, see Section 3-2-2.

6 VFO (LOCK) Key

The VFO key accesses the VFO mode which permits the operator to select a frequency and type of operation desired.

The (LOCK) key disables all the keys except for the PTT (Push-to-talk) and VFO keys. See 3-2-3 for operating instructions.

7 H/L Key

The H/L key toggles between high and low power. Push in for low power (5 Watts). High power is 45 Watts for VHF and 35 Watts for UHF.

8 SUB-band Dial

The SUB-band dial is rotated either clockwise or counterclockwise to select sub-band receive frequencies, memory channels, frequency steps, and sub-audible encode tone frequencies.

9 Power Switch/MAIN VOL (Main Volume) Knob

Turn knob clockwise to turn transmitter power on; fully counterclockwise to turn the power off. The MAIN VOL knob also controls the volume for main band operation. Turn clockwise to increase volume, counterclockwise to decrease volume.

10 MAIN SQL

(Main Band Squelch) Knob
The MAIN SQL knob controls the squelch circuit for main band operation. Turn knob fully counterclockwise, then turn knob clockwise until white noise disappears. Main band squelch is now set.

11 SUB VOL

(Sub-band Volume) Knob
The SUB VOL knob controls the volume on the sub-band. Turn clockwise to increase volume, counterclockwise to decrease volume.

12 SUB SQL

(Sub-band Squelch) Knob
The SUB SQL knob controls the squelch circuit for sub-band operation. Turn knob fully counterclockwise, then turn knob clockwise until white noise disappears. The sub-band squelch is now set.

13 SCAN (SKIP) Key

The SCAN key controls the scan function, toggling scan on and off. The following four scan functions are available: Program Scan, Memory Scan, VFO Scan, Open Channel Scan. See Section 3-3-2 for operating instructions.

The (SKIP) key selects which memory channels are to be skipped during the scanning operation. See 3-2-5 for operating instructions.

14 FUNCTION KEY

The FUNCTION key controls access to the secondary functions which are shown in amber on the face of the transceiver. See Section 3-2 for operating instructions.

15 SHIFT (PRIO) KEY

The SHIFT key controls the transmit frequency shift for repeater and simplex operation. Each time the key is pressed, the type of shift will change as follows:

Simplex→(-) Shift→(+) Shift→
*Split Operation

See Section 3-4-2, No. 1 for operating instructions.

The (PRIO) key activates the priority function. The VFO frequency is monitored for five seconds and then shifts for one second to the selected memory channel. See Section 3-2-7 for operating instructions.

16 ABX KEY

The ABX key controls the ABX function which exchanges the main band and sub-band automatically when the squelch circuit is open or senses a signal on the sub-band. See Section 3-3-4 for operating instructions.

17 TONE (T. SEL) KEY (DR-570E: Option)

The TONE key turns on/off the sub-audible encode tone and tone squelch functions. Each time the key is pressed, the function changes in the following sequence:

Tone off (nothing displayed)—Tone on ('T')—Tone squelch off ('CTCSS')

Display Indicators:

T = encoding function only, sub-audible encode tone is transmitted

CTCSS = encoding and decoding. Requires another operator with CTCSS capability to access the transceiver (or open the squelch) while CTCSS is active.

See Section 3-2-6 for operating instructions.

The (T. SEL) key programmes the sub-audible encode tone frequency to be transmitted when TONE function is selected. See 3-2-6 for operating instructions.

18 TWIN KEY

The TWIN key toggles the sub-band on and off. See Section 3-3-5 for operating instructions.

19 REV (STEP) KEY

The REV key reverses (or exchanges) the transmit/receive frequencies during duplex operation. The transceiver will transmit on the programmed receive frequency and receive on the programmed transmit frequency (reverse repeater operation). See Section 3-4-2 for duplex operation. The REV key is also used in the Open Channel Scanning function. See Section 3-3-2, D, for scanning operation.

The (STEP) key is utilized to choose the frequency increments/decrements for the VFO. See Section 3-2-1 for operating instructions.

20 MUTE (BEEP) KEY

The MUTE key reduces the sub-band volume approximately 20 dB. To activate mute, press MUTE key once. (The 'MUTE' indicator will light on the display.) To terminate, press MUTE key, returning the volume setting. (The 'MUTE' indicator light will extinguish.)

The (BEEP) key enables/disables the various "beep" tones which occur during transceiver operation. See Section 3-2-4 for operating instructions.

21 BAND (SUB) KEY

The BAND key exchanges the main and sub-bands each time it is pressed.

The (SUB) key puts the transceiver into the sub-band operation. See Section 3-2-9 for operating instructions.

22 CALL (BELL) KEY

The CALL key transfers memory channel 0 (the call channel) to the display. See Section 3-3-1, No. 3 for operating instructions. The (BELL) key activates tones when the squelch circuit is opened or a signal is detected on the frequency. Even if the volume is turned down, the 'bell' tones will chime alerting the operator to traffic on the frequency.

23 Microphone Connector

Used for connecting microphone or packet TNC. (For packet operation, refer to the packet equipment manuals.)

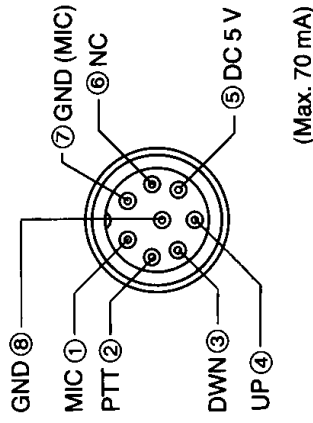

3-1-2. LCD Panel

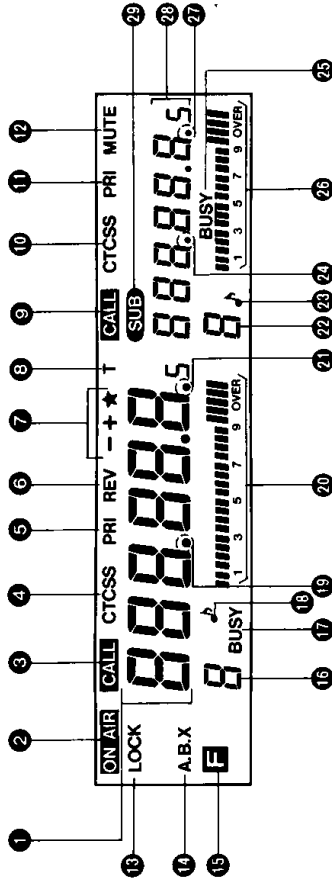

- 1 Main Band Frequency Indicator**
Displays main band transmit/receive frequencies, channel step and sub-audible encode tone frequencies.
- 2 'ON AIR' Indicator**
Lights during transmit mode.
- 3 Main Band 'CALL' Indicator**
Lights when main band call function is active.
- 4 Main Band 'CTCSS' Indicator**
Lights when main band tone squelch function is active.
- 5 Main Band 'PRI' Indicator**
Lights when main band priority function is active.
- 6 Reverse 'REV' Indicator**
Lights when reverse function is active.
- 7 Duplex ('-', '+', '*') Indicators**
Lights when duplex functions are active (- for negative shift, + for positive frequency shift and * for dual split shift).
- 8 Tone 'T' Indicator**
Lights when sub-audible encode tone is active.
- 9 Sub-band 'CALL' Indicator**
Lights when sub-band call function is active.
- 10 Sub-band 'CTCSS' Indicator**
Lights when sub-band tone squelch function is active.
- 11 Sub-band 'PRI' Indicator**
Lights when sub-band priority function is active.
- 12 'MUTE' Indicator**
Lights when mute function is active.
- 13 'LOCK' Indicator**
Lights when lock function is active.
- 14 'A.B.X.' Indicator**
Lights when ABX function is active.

- 15 Function 'F' Indicator**
Lights when the FUNCTION key is pressed for secondary function operation.
- 16 Main Band Memory Channel Number Indicator**
Displays the main band channel number currently active.
- 17 Main Band 'BUSY' Indicator**
Lights when main band squelch circuit is open or a signal is present.
- 18 Main Band Bell ('♪') Indicator**
Flashes when main band bell function is active.
- 19 Main Band MHz Decimal Point (':') Indicator**
Serves several functions for main band operation.
A. In transmit/receive operation, the frequency displayed to the left of the decimal is in MHz.
B. If sub-audible encode tone frequency is displayed, the frequency is displayed to the left of the decimal is in Hertz.
C. When scan function is active, decimal indicator flashes.
D. When memory skip is active, the indicator light extinguishes.
- 20 Main Band S/RF Meter**
Indicates main band signal strength during receive and RF output level during transmit.
- 21 Main Band kHz Decimal Point (':') Indicator**
Flashes during the open channel, main band scanning function.

- 22 Sub-band Memory Channel Number Indicator**
Displays the sub-band channel number currently active.
- 23 Sub-band Bell ('♪') Indicator**
Flashes when the sub-band bell function is active.
- 24 Sub-band MHz Decimal Indicator**
Serves several functions for sub-band. See No. 19, Main Band MHz Decimal Indicator.
- 25 Sub-band 'BUSY' Indicator**
Lights when sub-band squelch is open or a signal is present.
- 26 Sub-band S Meter Indicator**
Indicates signal strength of the sub-band receive signal.
- 27 Sub-band kHz Decimal Point (':') Indicator**
Flashes during the open channel, sub-band band scanning function.
- 28 Sub-band Frequency Indicator**
Displays sub-band receive frequencies, channel step and sub-audible encode tone frequencies for sub-band.
- 29 Sub-band 'SUB' Indicator**
Lights when sub-band functions are active.

3-1-3. Rear Panel

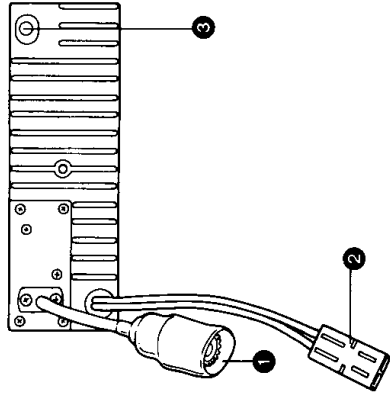

1 Antenna Terminal Connector

Is utilized for both bands. This unit is fitted with an internal duplexer with a 50 ohm impedance.

2 Power Supply Connector

Connects with the power cord to the power supply. The red lead of the power cord is positive and must be connected to the (+) side of the supply/battery. the black lead is negative and must be connected to the (-) side of the supply/battery.

CAUTION:

Failure to connect the transceiver properly will result in damage to transceiver.

3 External Speaker Jack

A miniature jack connector for an 8 ohm external speaker.

3-1-4. Microphone

(DR-570E)

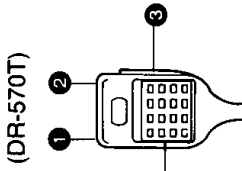
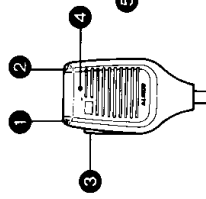

1 2 Microphone UP/DOWN

Keys

The microphone UP/DOWN keys, when pressed, change transmit/receive frequencies, memory channels, frequency step and sub-audible encode tone frequency selections. Press and hold for continuous operation.

3 PTT (Push-to-Talk) Key

Press for transmit operation.

4 LED

Lights on transmission.

5 DTMF keyboard

3-2. FUNCTIONS

Many of the transceiver keys offer two individual functions. The function in white is the primary function. To activate the primary functions, press the desired key. To access the amber, secondary commands, first press FUNCTION key. The 'F' indicator on the LCD will light up confirming that the unit is prepared for all secondary commands. Next, select and press the desired function key.

NOTE:

To cancel the FUNCTION key, press FUNCTION key again and the 'F' indicator light will extinguish.

3-2-1. Frequency Step Selection

The frequency step selection function selects the frequency increments desired by the operator for VFO operation. When the main band or sub-band dial is rotated "one click" or the microphone UP/DOWN keys are pressed once, the frequency will increment or decrement in the amount of the frequency step selection. (Operation for main band and sub-band is exactly the same.)

Example:

If 5 kHz is chosen, the frequency will step from 144.800 to 144.805 to 144.810 to 144.815...etc.

If 10 kHz is chosen, the frequency will step from 144.800 to 144.810 to 144.820...etc.

1. Press VFO key to activate the VFO mode.
2. Press FUNCTION key. (The 'F' indicator will light on the display.)
3. Press (STEP) key.
4. The current band channel step frequency in use will be displayed on the band frequency indicator.
5. When the main band (or sub-band) dial is rotated clockwise one click (or the microphone UP key is pressed once), the main band channel step will change in the following sequence.

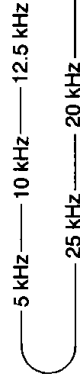

NOTE:

When the main band dial is rotated counterclockwise one click (or the microphone DOWN key pressed once) during this operation, the sequence is reversed.

3-2-2. Memory Storage

The ALINCO DR-570T has 20 memories, 10 for each band. The information that can be stored in each memory channel includes TX/RX frequencies, shift condition and encode/decode frequency. The channels are numbered 0-9. To access the stored memory, press MR key and rotate the main band (or sub-band) dial or press microphone UP/DOWN keys until the desired channel number appears on the display. (Operation for main band and sub-band is exactly the same.)

NOTE:

When programming the memory channels, be aware that some memory channels function in other capacities, such as:

MEMORY CHANNEL NO.	FUNCTION
0	CALL function (see Section 3-3-1, No. 3)
7-8	VFO scan frequencies (see Section 3-3-2, No.6)
9	Transmit frequency for dual split shift function (see 3-4-2, No.3)

To program the memory:

1. Press MR key and select the memory channel to be programmed.
2. Press VFO key and to select frequency to be stored in memory.
3. At this time, if desired, select the **desired shift** (see 3-4-2, No. 1 and 2) or **sub-audible encode** tone frequency (see 3-2-6, No. 1).
4. Press FUNCTION key. (The 'F' indicator will light on the display.)
5. Press (MW) key and the selected information will be written to the desired memory channel.

To clear programmed memory:

1. Reprogram new information (repeat steps above) for each individual memory channel.
2. See 3-5, Master Reset to clear all memories. Caution should be exercised using this function.

3-2-3. Lock Function

The lock function disables all the keys (on the transceiver and the microphone) with the exception of the PTT key and VFO key.

To activate key lock:

1. Press FUNCTION key. (The 'F' indicator will light on the display.)
2. Press (LOCK) key. (The 'LOCK' indicator will light on the display.)

To terminate the lock function:

1. Press VFO key again. (The 'LOCK' indicator light will extinguish.)

3-2-4. Beep Tone

The beep tone function offers the operator the option to suppress the transceivers beep tones. The (BEEP) key toggles on and off the beep tone function.

NOTE:

To activate the bell function, beep tones must also be active.

To activate beep tones:

1. Press FUNCTION key. (The 'F' indicator will light on the display.)
2. Press (BEEP) key. (An audible 'beep' will sound to indicate that the beep tones are active.)

To terminate the beep tone:

1. Press FUNCTION key. (The 'F' indicator will light on the display.)
2. Press (BEEP) key. (No beep will sound indicating that the beep function has been terminated.)

3-2-5. Memory Skip

The memory skip function causes the selected memory to be skipped during the scanning function. (Operation for main band and sub-band is exactly the same.)

To activate memory skip:

1. Press MR key, putting the transceiver into the Memory mode.
2. Select the memory channel with either the main band (or sub-band) dial or microphone UP/DOWN keys.
3. Press FUNCTION key. (the 'F' indicator will light on the display.)
4. Press (SKIP) key. The MHz decimal point indicator light will extinguish. The memory skip function for that memory channel will be active.

To cancel memory skip and insert skipped memory(ies) back into the scanning rotation:

1. Stop SCAN function (if active).
2. Step up or down to the memory number to be re-inserted.
3. Press FUNCTION key. (The 'F' indicator will light on the display.)
4. Press (SKIP) key. (The MHz decimal point indicator will light on the display and the unit will now scan that memory.)

3-2-6. Sub-audible Encode Tone Frequency Set-up, Encoding (T), Tone Squelch (CTCSS)

(DR-570E: Option)

The sub-audible encode tone frequency set-up function establishes the desired sub-audible encode tone frequency to be used in transmit for encode only and encode/decode functions.

The encode only function transmits the sub-audible encode tone each time the transmitter is keyed. (Sometimes required for repeater operations.)

The tone squelch (CTCSS) function is an encode/decode operation. The transceiver will operate in a muted state until a signal (from another transmitter) is received with the proper tone. At that time, the squelch circuit will be open. This permits a selected monitoring situation.

The TONE key turns on/off the sub-audible encode tone and tone squelch (encode/decode) functions. Each time the key is pressed the function changes in the following sequence:
Tone off (nothing displayed) — Tone on (T)
— Tone squelch off (CTCSS)

Display Indicators:

T = encoding function only, sub-audible encode tone is transmitted.

CTCSS = encoding and decoding. Requires another operator with CTCSS capability to access the transceiver (or open the squelch) while CTCSS is active.

(Operation for main band and sub-band is exactly the same.)

1. To access sub-audible encode tone frequency selection function:

1. Press FUNCTION key. (The 'F' indicator will light on the display.)
2. Press (T. SEL) key. (The sub-audible encode tone frequency currently in use will appear on the display.)
3. Select the desired sub-audible encode tone frequency by rotating the main band (or sub-band) dial or pressing the microphone UP/DOWN keys. The DR-570T offers 37 different sub-audible encode tone frequencies listed below.

Subaudible Tone Chart

Hz	Hz	Hz	Hz	Hz	Hz
67.0	85.4	107.2	131.8	162.2	203.5
71.9	88.5	110.9	136.5	167.9	210.7
74.4	91.5	114.8	141.3	173.8	218.1
77.0	94.8	118.8	146.2	179.9	225.7
79.7	100.0	123.0	151.4	186.2	233.6
82.5	103.5	127.3	156.7	192.8	241.8
					250.3

NOTE:

Pressing any other keys than those designated in the instructions, will terminate the sub-audible encode tone frequency set-up operation and the receive frequency indicator will return to the display.

To terminate this function:

1. Press TONE (T. SEL) again.

2. To activate the encode only:

1. Select the desired sub-audible encode tone (see No. 1, sub-audible encode tone frequency selection).
2. Press TONE key. (The 'T' indicator will light on the display.)

To terminate encode only function:

1. Press TONE key two more times or until tone indicators ('T', 'CTCSS') extinguish.

3. To activate the tone squelch (CTCSS) function:

1. Select the desired sub-audible encode tone (see No. 1, sub-audible encode tone frequency selection).
2. Press TONE key twice. (The 'CTCSS' indicator will light on the display.)

NOTE:

While in this function, to receive a transmission from another station, the other operator must transmit the same sub-audible encode tone.

To terminate the tone squelch (CTCSS) function:

1. Press TONE key one more time or until the tone indicators ('T', 'CTCSS') extinguish.

3-2-7. Priority Function

While the priority function is active, the transceiver will receive the VFO frequency for five seconds and the selected memory channel for one second. When a signal is received on the priority channel (memory channel), the beep tone will sound, alerting the operator. To respond to the priority channel, the operator must press either the FUNCTION key or the SHIFT (PRIO) to terminate the priority function. (Operation for main band and sub-band is exactly the same.)

NOTE:

The priority function activated for both main band and sub-band offer the operator the ability to monitor four frequencies simultaneously. If this operation is chosen, the sub-band priority must be set first. Wait 10 seconds for the sub-band functions to automatically revert to main band and set main band priority.

To activate the priority function:

1. Press MR key and select the desired "priority" channel.
2. Press VFO key and select the desired frequency for use.
3. Press FUNCTION key. (The 'F' indicator will light on the display.)
4. Press (PRIO) key. (The 'PRIO' indicator will light on the display and priority function operation will begin.)
5. To access or use the "priority" channel, press (PRIO) key. This terminates the priority function. (The 'PRIO' indicator will extinguish.)
6. To return to priority operation, repeat steps 1 and 2.

To terminate the priority function:

1. Press FUNCTION key. (The 'F' indicator will light on the display.)
2. Press (PRIO) key. (The 'PRIO' indicator will extinguish.)

3-2-8. Bell Tones

The (BELL) key activates tones when the squelch circuit is opened or a signal is detected on the frequency. Even if the volume is turned down, the 'bell' tones will chime alerting the operator to traffic on the frequency.

NOTE:

To activate the bell function, beep tones must also be active (see Section 3-2-4).

To activate bell tones:

1. Press FUNCTION key. (The 'F' indicator will light on the display.)
2. Press (BELL) key. (The 'BELL' indicator will flash on the display.)

To terminate the bell tones:

1. Press FUNCTION key. (The 'F' indicator will light on the display.)
2. Press (BELL) key. (The flashing 'BELL' indicator light will extinguish.)

3-2-9. Sub-band Functions







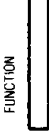

NOTE:

If no action is taken 10 seconds after activating the SUB-band function, the 'SUB' indicator light will extinguish and operation will return to the main band.

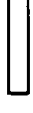
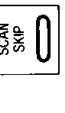
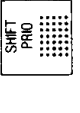
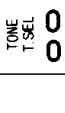
1. Press FUNCTION key. (The 'F' indicator will light on the display.)
2. Press (SUB) key. (The 'SUB' indicator will light on the display.)
3. While the sub-band operation, the microphone UP/DOWN keys are active for the sub-band.
4. The chart below explains all of the operations available when in sub-band operation.

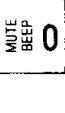
To terminate sub-band operation and return to main band operation:

1. Press FUNCTION key. (The 'F' indicator will light on the display.)
2. Press (SUB) key. (The 'SUB' indicator light will extinguish.)

Keys	White key Functions	Amber Key Function (After Pressing FUNCTION Key)
	Sub-band memory channel number indicator lights on display. (The 'F' indicator lights on the display.)	Sub-band functions return to normal (Main Band Operation).
	Same operation as when using main band.	Same operation as when using main band.
	'SUB' indicator light extinguishes. Main band is operational.	'SUB' indicator light extinguishes. Main band is operational.
	Same operation as when using main band.	'SUB' indicator light extinguishes. Main band is operational.
	Scans sub-band.	Activates skip channels for sub-band.
	Sets up direction and presence of shift in frequency band which has been set up in the sub-band.	Sets up priority channels in the sub-band. Method of operation identical to the main band operation.
	Activates CTCSS and sub-audible encode tone set-up for sub-band.	Sets up the tone frequency for sub-band operation.
	Activates reverse operation for sub-band.	Sets up channel step increments for sub-band.
	Same operation as when using main band.	Same operation as when using main band.
	Call channel function for sub-band.	Establishes sub-band bell function for sub-band.
	Puts sub-band into VFO mode.	Same operation as when using main band.
	Puts sub-band into memory mode.	Writes memory frequency information to sub-band.

3-3. RECEIVE

3-3-1. Frequency Set

1. VFO Mode

When the main band (or sub-band) dial is rotated clockwise one click, the frequency increases one increment (see 3-2-1 to establish increment of frequency). The frequency decrements if the main band (or sub-band) dial is rotated counterclockwise. The same is true for the microphone UP/DOWN keys. If the UP/DOWN key is pressed continuously, the change is more rapid. When the frequency changes as shown below, audible 'Beep' tones will sound.

- 500 kHz
- 1 MHz
- When shifting from the upper frequency limit to the lower frequency.
- When shifting from lower frequency limit to upper frequency.
- When it coincides with the memory write-in frequency.

2. Memory Mode

When the main band (or sub-band) dial is rotated clockwise, the memory channel increments one channel per click. The frequency decrements if the dial is rotated counterclockwise. When the microphone UP key is pressed, the memory channel increments one channel. When the microphone DOWN key is pressed, the memory channel decrements one channel. When either of the microphone UP/DOWN keys are pressed continuously, the change is more rapid. (See Section 3-2-2 for memory storage.)

3. Call Channel

The call channel is memory channel 0; it can be accessed directly at any time during transceiver operation. (Operation for main band and sub-band is exactly the same.)

To access the call channel:

1. Press CALL key. (The 'CALL' indicator and the contents of memory channel 0 will light on the display.) Call channel function is now active.

To terminate call channel:

1. Press VFO or MR key. (The 'CALL' indicator will extinguish.)

3-3-2. SCAN Operation

The SCAN key toggles the scan function on and off. The following four modes of scan function are available: Program scan, memory scan, VFO scan, and open channel scan. (Operation for main band and sub-band is exactly the same.)

A. Program Scan

Program the frequency range to be scanned into memory channels 7 and 8. (It does not matter which frequency is high or low. See 3-2-2 for memory setting instructions.)

NOTE:

If, when the SCAN key is pressed, the frequency displayed is outside the range of memory 7 and 8, scanning will begin at the displayed frequency (up or down). The scanning will continue to the end of the band and start at the other end of the band. During the next pass, scanning will be confined to the range of memory 7 and 8.

B. Memory Scan

While in the memory mode, the memory channels are scanned in memory order (unless memory channels are locked out by the memory skip function, see 3-2-5).

C. VFO Scan

When memory channels 7 and 8 are each set to the ends of the VFO band, the full VFO band will be scanned. (See Section 3-2-2 for memory setting instructions.)

D. Open Channel Scan

If the REV key is pressed, during scan operation, open channel scan is active. This function is directly opposite to the normal scan operation (busy scan). Scanning will pause at the open, or unoccupied, frequency. During open channel scan, the MHz decimal point and the KHz decimal point indicators will flash simultaneously.

To activate the scan function:

NOTE:

If transceiver is in CTCSS function ('CTCSS' indicator is lit on the display), only signals which are transmitting the set sub-audible code tone frequency will open the squelch circuit. See 3-2-6 Tone Squelch Function (CTCSS).

1. Set squelch. (see Section 3-2-1, No. 10)

2. Press SCAN key once. The frequency (and memory—if applicable) indicator will appear scanning on the display. The MHz decimal indicator will flash on the display. The scanning function will be active. Scanning is done in upward increments. For details on Program scan, Memory scan, VFO scan, and Open channel scan, see A-D, above. For downward scanning, see step No. 4.
3. When a signal is detected on the frequency currently shown on the display, the scanning will stop for five seconds on the frequency before resuming. To stop the function at any frequency, press SCAN key again and scanning will be terminated. (Should the signal cease, scanning will be resumed two seconds after loss of signal.)
4. To scan downward, press microphone DOWN key or rotate main band (or sub-band) dial counterclockwise. To return to upward scanning, press microphone UP key or rotate main band (or sub-band) dial clockwise.

To terminate the scan function:

1. Press SCAN key again. The display will return to normal.

NOTE:

Pressing the PTT key (transmitting) will also terminate the scanning function.

3-3-3. Tone Squelch Function

See 3-2-6 Sub-audible Encode Tone Frequency Set-up, Encoding, and Tone Squelch Function (CTCSS), No. 1 and 3 for operating instructions.

3-3-4. ABX (Auto Band Exchange) Function

When in the ABX function is active, a detected incoming signal on the sub-band will activate an automatic exchange between the main band and the sub-band.

NOTE:

While the bands are exchanged, the frequency cannot be altered.

To activate ABX function:

1. Press ABX key. (The 'A.B.X.' indicator will light on the display.)
2. When an incoming signal is detected on the sub-band, the main band and sub-band will exchange. (The 'A.B.X.' indicator will flash on the display.) This condition will remain as long as the sub-band signal is present.
3. Transmitting in this condition will automatically terminate the ABX function. (The 'A.B.X.' indicator light will extinguish.) The frequencies will remain 'switched'.
4. Unless the transmit mode is activated, the frequencies will return to normal (switch back) three seconds after loss of signal.

To terminate ABX function:

1. Press ABX key again. (The 'A.B.X.' indicator light will extinguish.)

NOTE:

Transmitting while in ABX will automatically terminate the ABX function. (The 'A.B.X.' indicator light will extinguish.)

3-3-5. Single Band/Dual Band Simultaneous Reception

The TWIN key toggles the sub-band on and off.

To activate and extinguish the sub-band:

1. Press TWIN key. (The sub-band frequency and memory indicator lights will extinguish.)

To terminate (and return the sub-band):

1. Press TWIN key. (The sub-band frequency and memory indicators will reappear on the display.)

TRANSMIT

Transmitting is done from the main band only. The sub-band is receive only operation. They are basically two transmit modes, simplex and duplex. Simplex mode is transmitting and receiving on the same frequency. Duplex mode is transmitting on one frequency and receiving on another frequency. Duplex is the common mode of operation for repeaters. When in the transmit function (either mode), the 'ON AIR' indicator lights on the display.

3-4-1. Simplex Mode

1. Verify that the shift indicators ('-', '+', '+') do not appear on the display. (If they do, press SHIFT key until they disappear.)
2. Select the desired frequency on the main band.
3. Depress the microphone PTT key and speak facing the microphone.
4. When the PTT key is released, the transceiver returns to the receive condition.

3-4-2. DUPLEX Mode

In duplex mode, receiving and transmitting are done on two separate frequencies. The DR-570T has the following three types of duplex operation: Automatic shift [minus shift (1), plus shift (2), and dual split shift (3)], reverse shift (4) and cross band full duplex (5). When activating the automatic frequency shifts, the operator chooses the receive frequency and the transceiver shifts (per programming) the transmit frequency.

There are three possible types of automatic frequency shifts: minus (-) shifts, plus (+) shift and dual shift. The actual amount of frequency shift is automatically established. For 144 MHz, the frequency shift is 600 kHz; for 450 (430) MHz, the frequency shift is 5 MHz. The reverse shift is simply a reversing of the automatic shifts (see No. 4). Cross band full duplex is transmitting on one band and receiving on the other (see No. 5).

Be careful to choose a frequency shift which will remain within the amateur radio frequencies. The DR-570T will not transmit outside the amateur radio frequency boundaries.

NOTE:

If an attempted out-of-band transmission is attempted, the 'OFF' indicator will light on the display and the transceiver will not transmit.

1. Minus (-) Shift

1. Press SHIFT key once. (The '-' indicator will light on the display.)
2. Depress the microphone PTT key, and speak facing the microphone.
3. When the PTT key is released, the transceiver returns to the receive condition.

Transmissions will now automatically occur below (lower frequency) the chosen receive frequency. The frequency indicator will display the transmit frequency during transmissions and will return to the receive frequency after transmission has ceased.

Example:

- 144.88 receive frequency with a minus shift causes the transceiver to transmit on 144.28 (600 kHz below the receive frequency).

To terminate the minus shift function, press SHIFT key three times or until the shift indicator lights (-, +, *) extinguish.

2. Plus (+) Shift

1. Press SHIFT key two times. (The '+*' indicator will light on the display.)

NOTE:

If moving from a minus shift (-), press SHIFT key only once.

2. Press the microphone PTT key, and speak facing the microphone.
3. When the PTT key is released, the transceiver returns to the receive condition.

Transmissions will now automatically occur above (higher frequency) the chosen receive frequency. The frequency indicator will display the transmit frequency during transmissions and will return to the receive frequency after transmission has ceased.

To terminate the plus shift function, press SHIFT key two times or until the shift indicator lights (-, +, *) extinguish.

3. Dual (*) Split Shift

1. Enter the desired transmit frequency into memory channel 9. (See Section 3-2-2 for memory channel instructions.)
2. Select the desired receive frequency.
3. Press SHIFT key three times. (The '* ' indicator will light on the display.)

NOTE:

If moving from the (+) shift, press SHIFT key only once.

4. Depress the microphone PTT key, and speak facing the microphone.
5. When the PTT key is released the transceiver returns to the receive condition.

Regardless of the chosen receive frequency, transmissions will now automatically occur on the frequency stored in memory channel 9. The frequency indicator will display the transmit frequency during transmissions and will return to the receive frequency after transmission has ceased.

To terminate the Shift function, press SHIFT key once or until the shift indicator lights (-, +, *) extinguish.

4. Reverse Function

While in any of the automatic frequency shift duplex modes (3-4-2 No. 1, 2, or 3, above), the operator may elect to reverse, or exchange, the receive and transmit frequencies.

To activate the reverse function:

1. Press REV key. (The 'REV' indicator will light on the display.)

The frequency indicator will display the exchange receive frequency. When in the transmit mode, the exchange transmit frequency will be displayed.

To terminate the reverse function:

1. Press REV again. The 'REV' indicator light will extinguish.

5. Cross Band Full Duplex Mode

The cross band full duplex is simultaneous receiving and transmitting. By utilizing the sub-band for receive and main band simplex mode for transmit, it is possible to simultaneously transmit and receive.

NOTE:

If the chosen receive frequency is exactly three times the transmit frequency, the receive sensitivity becomes extremely poor.

Example: 147.000 and 441.000 (U.S. version)

To activate cross band full duplex:

1. Select the transmit frequency by rotating the main band dial or by pressing the microphone UP/DOWN keys.

2. Verify that the shift indicators ('-', '+', '*') do not appear on the display. (If they do, press SHIFT key until they disappear.) This puts the transceiver in simplex mode.
3. Select the receive frequency by rotating the sub-band dial.
4. Adjust the SUB VOL (sub-band volume) knob for comfortable listening.

3-4-3. Sub-audible Encode Tone Encoder

See 3-2-6 Sub-audible Encode Tone Frequency Set-up, Encoding, and Tone Squelch Function (CTCSS), No. 1 and 2 for operating instructions.

INSTALLATION

3-5. MASTER RESET

CAUTION:

This will erase ALL INFORMATION entered or stored in memory. All memories, main band and sub-band, will be erased.

In the event that the LCD display is not correct, or to erase all information entered or stored into the memory, proceed with the following steps:

1. With the FUNCTION key continuously depressed, turn the power off and on.
2. The frequency formerly displayed will disappear and the call frequency (memory channel 0) will be displayed.
3. When reset occurs, the setup values will be as shown in the table below:

	Main Band (E)	Sub-Band (E)
Indicated Frequency	145.000	445.000 (433.000 MHz)
Memory Channel	1	1
Channel Step	5 kHz (12.5 kHz)	5 kHz (12.5 kHz)
Offset direction	None	None
Offset frequency	600 kHz	5 MHz (7.6 MHz)
Sub-audible Encode Tone Encoder	None	None
Tone Frequency*	88.5 Hz	88.5 Hz
Memory Channel Frequency	145.000	445.000 (433.000 MHz)

*Not applicable in US

MOBILE INSTALLATION

1. Location

The transceiver may be installed in any position in your car, where the controls and microphone are easily accessible and safe operation of the vehicle or the performance of the set will not be interfered with. Refer to the diagrams for installation of the Mounting Bracket:

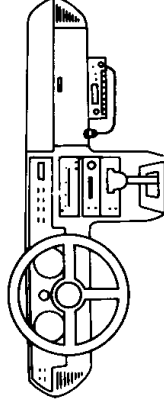

2. Power Requirements

The transceiver can be operated from any regulated 12 or 13.8 V negative ground source. For mobile use, power connections should be made directly to the battery to minimize the possible ignition noise pickup.

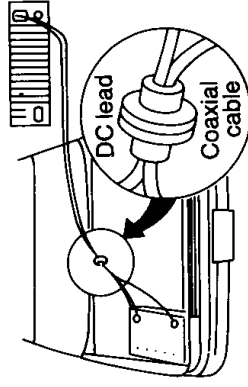

BASE STATION INSTALLATION

For fixed base operation, a 13.8 V D.C. Power Supply capable of providing at least 15 A continuously is required. Connect the red lead of the power cable to the Positive (+) terminal, and the black lead to the Negative (-) terminal of the D.C. Power Supply.

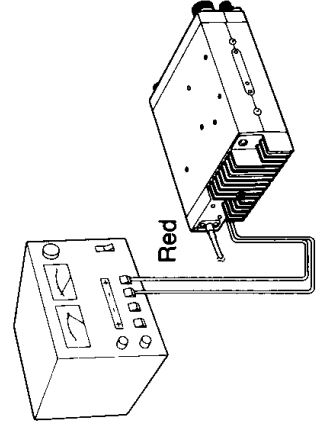
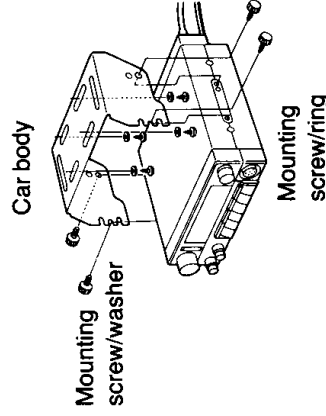

5. SPECIFICATIONS

■ General

Frequency Coverage 144.0~148.0 MHz (DR-570T)
440.0~450.0 MHz
144.0~146.0 MHz (DR-570E)
430.0~440.0 MHz

Antenna Impedance 50 ohms unbalanced

Power Supply

Requirement 13.8 Volts D.C.

Current Drain at 13.8 V Receiving

Squelched: does not exceed 500 mA

Transmitting

High: 45 W approx. 9.8 A at VHF

35 W approx. 10.3 A at UHF

Dimension 150 mm (W) × 50 mm (H) × 173 mm (D)
(6" × 2" × 6^{15/16"})

Weight Approx. 1.7 kgs. (3.75 lbs.)

■ Transmitter

Output Power High: 45 Watts at VHF, 35 Watts at UHF

Low: Approx. 5 Watts at both bands

Emission Mode 16F3

Modulation System Variable Reactance F.M.

Max. Frequency Deviation ±5 kHz

Spurious Emission More than 60 dB below carrier

Microphone Electret Condenser Microphone

Operating Mode Simplex

Duplex: ±600 kHz from receive

frequency at VHF

: ±5, 1.6, 7.6 MHz from receive

frequency at UHF

(Odd offsets programmable)

DTMF Encoder Built-in

■ Receiver

Receiving System Superhetrodyne, dual conversion

Modulation Acceptance 16F3

Intermediate Frequency 1st 10.7 MHz 2nd 455 kHz at VHF

1st 30.825 MHz 2nd 455 kHz at UHF

Sensitivity 12 dB SINAD less than 0.16 μV

Selectivity More than ±6 kHz at -6 dB

Less than ±12 kHz at -60 dB

Audio Power Output More than 1.5 Watts (8 ohms-10% Distortion)

Speaker Impedance 8 ohms