



PROFESSIONAL MONITOR RECEIVER

AR-3000A

INSTRUCTION MANUAL



- BLANK -

Introduction:

Thank you for purchasing the AR3000A wide-range receiver. The AR3000A is a highly sophisticated piece of equipment using the very latest in electronics design and technology. It is important that you carefully read this handbook and familiarise yourself with the receiver before placing it into operation.

The AR3000A has been passed through stringent quality control testing at the factory and should provide many, many hours of pleasurable listening.

The last section of this handbook carries a brief guide of operational techniques to help you gain the very best from the receiver.

Accessories supplied:

1. AC Adaptor (240V for the UK)
2. 12V DC lead
3. Telescopic whip aerial
4. English language handbook



Every effort has been made to make this manual correct and up to date. Due to continuous development of the receiver and by error or omissions anomalies may be found and this is acknowledged.

Most apparent faults are due to accidental miss-operation of the receiver, carefully read all of the manual before deciding to return the receiver for repair.

Although carefully designed, this receiver (like all receivers) suffers from a degree of internal noises known as spurious. They are a product of the receiver's circuitry and do not represent a fault.

Due to the lock and unlock characteristics of the PLL (Phase Lock Loop) frequency control system employed, an audible 'click' may be noticed while tuning certain bands or modes. This is normal for the AR3000A (and many other receivers) and does not represent a fault.

This manual is protected by copyright AOR Ltd 1992. No information contained in this manual may be copied or transferred by any means without the prior written consent of AOR Ltd.

(C) 1991, 1992 AOR Ltd. Japan.

INDEX:

(1) Major features	4
(2) Precautions	6
(3) Installation and connections	7
3-1 When used with 12V DC	7
3-2 When used with AC mains	7
(A) When used with the telescopic aerial	7
(B) When used with an indoor aerial	8
(C) When used with an external aerial	8
(4) Controls and functions	9
4-1 Display unit	9
4-2 Front panel	10
4-3 Rear panel	13
(5) Operation	14
5-1 Basic operations	14
5-2 Operation in each specific receive mode	15
(A) Dial mode	15
A-1 Direct frequency selection from Ten-keypad	15
A-2 Manual tuning by main rotary tuning knob	18
(B) Dial search mode	20
(C) Program search mode	22
C-1 Frequency selection by program search	22
C-2 Setting delay time	23
(D) Memory channel mode	24
D-1 Writing memory channel data	24
D-2 Frequency selection by memory channel	26
(E) Memory scan mode	27
E-1 Squelch control	27
E-2 Frequency selection by memory scan	27
E-3 Memory pass channels	28
E-4 Cancelling memory channels	29
(E) Priority channel mode	30
F-1 Frequency selection by priority channel	30
F-2 Setting priority interval time	31
5-3 Function key	32
(A) Step key	32
(B) Step adjust key	33
(C) Shift key, shift set key	34
(D) Pause key	35
D-1 Setting pause time	35
D-2 Pause scan	36

(E)	Frequency pass key	37
E-1	Entering pass frequencies	37
E-2	Confirming the entry of pass frequencies	37
E-3	Deleting pass frequencies	38
E-4	Entering pass frequencies from the keypad	38
(F)	Real time clock facility	39
F-1	Clock time set key	39
F-2	Clock display key	40
(G)	Sleep timer operation	40
G-1	Sleep time set key	40
G-2	Sleep time On/Off key	41
(H)	Alarm facility	42
H-1	Alarm time set key	42
H-2	Alarm time On/Off key	43
(6)	Useful tips for operating the AR3000A	44
6-1	Headphone and earphone connection	44
6-2	External loudspeaker connection	44
6-3	Automatic tape recording	45
6-4	Facsimile reception	46
6-5	Satellite reception	47
6-6	Computer remote control via PC	48
(A)	Initial setting	48
(B)	RS232C mode	49
(C)	Input command	49
(D)	Enter commands	50
(E)	Output command	51
(7)	Specification	52
(8)	References	53
8-1	Internal spurious signals	53
8-2	S-Meter (Signal strength meter)	53
8-3	Default setting	53
8-4	Microprocessor reset	54
(9)	Trouble shooting	55
(10)	Optional accessories	56

(1) Major features.

(1) Major features.

Your listening horizons are truly extended by the AR3000A. The frequency coverage is extremely broad ranging from 100 kHz all the way up to 2036 MHz without any gaps in the range. The receiver offers the widest range on the market place today with a high level of performance and versatility from longwave through shortwave, VHF and onward to the upper reaches of UHF and SHF.

Not only will the AR3000A cover this extremely wide range, it will allow listening on any mode: NFM, WFM, AM, USB, LSB and CW.

Single Side Band (SSB) is a general term given to two additional modes of operation USB (Upper Side Band) and LSB (Lower Side Band).

SSB is used by many services especially on the shortwave bands (including Oceanic Airband, Marine, Amateur band) in order to extend the operational coverage of their radio transceivers. It's inclusion in the AR3000A isn't just an added bonus but a positive asset.

A very high level of RF performance has been achieved by using 13 band pass filters before the GaAsFET RF amplifiers unlike other receivers which may largely rely on broad band amplifiers. This ensures high sensitivity throughout the range with outstanding dynamic range and freedom from intermodulation effects.

Tuning rates are selectable from an ultra-fine 50 Hz step for SSB and CW right the way up to 999.95 kHz for the TV bands and Band-2. Two front panel buttons, $\times 10$ increase and $\times 5$ decrease allow step adjustment by a single key stroke, this further increases versatility and operational pleasure. A 'free running' rotary tuning control provides the very best method of user interface especially when listening in the SSB modes.

The large and comprehensive front panel Liquid Crystal Display (LCD) has an ideal 12 o'clock viewing angle for best visibility. A multitude of information is displayed including Search, Scan,

Frequency, Signal strength, RF attenuator, Memory bank changeover etc. Illumination is provided to increase visibility in areas of low level lighting. The display includes a real time clock for accurate log keeping, there is also a timer and record output for unattended operation.

400 memory channels are provided in 4 banks ×100 channels. Each memory channel will retain Mode, Frequency, RF attenuator setting, Lockout status and Step size. The first channel of each memory bank may be used as a priority channel, thus providing four channels in total. All memory and search programmed information is retained by an internally fitted lithium battery.

Four search banks have been provided, each bank may be programmed by the user to operate anywhere within the receiver's frequency range. As an aid to searching, 100 individual frequencies may be locked out of each search bank to prevent the receiver from stopping on unwanted or continuously occupied frequencies. Enhanced programmable hold and variable pause facilities have been provided within the search, scan and priority modes, this ensures the very highest level of versatility.

Search and scan speed has a maximum possible rate of 50 increments per second although 30 would be typical.

An RS232C port is provided enabling remote control via most computers (commercial PC-based software available). Control facilities include: Frequency, Receiver mode, Frequency steps, Write to / from memory, Signal strength, RF attenuator, Memory bank select etc. A rear panel switch changes control between the keypad and RS232C port.

Available options include:

DA3000 wide band discone aerial 25 - 2000 MHz.

WA5000 active wide band compact aerial 30 kHz - 2000 MHz

LA-320 longwave - shortwave active desktop loop aerial

MM1 mobile mounting bracket

ACEPAC3A PC computer control software

(2) Precautions.

(2) Precautions.

Power requirements.

The AR3000A is designed for operation only from a nominal 12 V DC supply. Always use the correct power supply or cable (provided), making sure to observe the correct polarity for positive and negative connections.

For home use a power supply must be used, it must have a 12 - 14 V DC regulated output and be capable of supplying in excess of 300mA.

The AR3000A is supplied with both DC power lead and AC adaptor (with the correct voltage for the designated market area) as standard accessories for mobile and home use.

Disconnect the AC adaptor from the AC mains supply if the receiver is not being used. Take care to avoid spillage or leakage of liquids into the receiver and AC adaptor. Special care should be taken to prevent liquid entering via the power jack.

Installation.

Do not use or leave the receiver in direct sunlight. It is best to avoid locations where excessive heat, humidity, dust and vibration are expected. Always treat the receiver with care.

Aerial.

For reception of weak signals and external aerial is highly recommended. Various suitable aerials are available from AOR as optional accessories in both discone and active formats. When erecting an external aerial take care not to interfere with nearby power and telephone cables.

Look after your receiver.

Always use a soft dry cloth to gently wipe the set clean. Never use chemicals such as benzine or thinners which will damage the plastic outer case and parts.

(3) Installation and connections.

3-1 When used with DC power source.

Use the supplied DC lead to connect the receiver to a 12V DC power source. The utmost care must be taken to ensure the correct polarity of positive and negative connections. The receiver may be seriously damaged if the polarity is reversed. For mobile use, a fused cigar lighter plug may be fitted to the lead (a 2A fuse is recommended).

The MM1 mobile mounting bracket is available as an optional accessory. (The red lead is positive and the black negative).

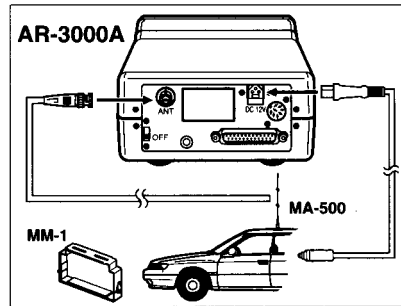

3-2 When used with a mains power supply.

The AR3000A is supplied with an AC mains adaptor as a standard accessory. The input voltage of this device will be appropriate for the specific market place. Do not use other AC adaptors as damage to the receiver may result. In in doubt, please consult your supplier.

It is essential to choose the correct aerial to suit your listening environment.

(A) Using the supplied telescopic aerial.

The telescopic whip aerial is ideal for portability and areas of strong signals. The length of the aerial may be altered to improve reception on specific frequencies and bands. Generally speaking, once above VHF the higher the frequency, the shorter the aerial needs to be.

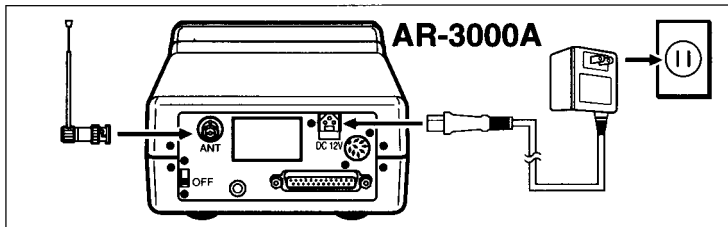

(3) Installation and connections.

(B) Using an indoor aerial.

Indoor aerials cannot perform as well as external aerials mounted in clear space. Generally speaking, loft mounted aerials produce disappointing results. The optional LA320 desk-top active loop aerial will enhance the receive performance over the longwave to shortwave bands.

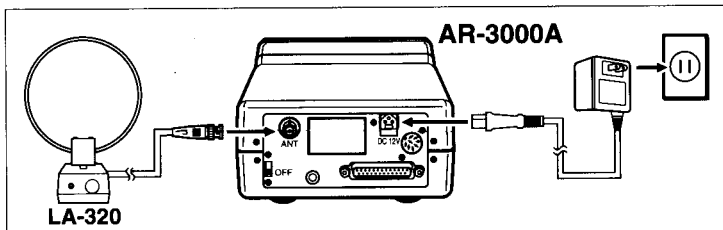

(C) Using an external aerial.

External aerials produce the best results. Aerials should be mounted as high as possible and in clear space. Do keep the coaxial cable run as short as possible to avoid excessive signal loss.

If the location is in an area of high signal strength, the external aerial may produce overloading. This will not damage the receiver but may lead to many signals 'mixing' together causing hissing noises or blocking the reception of certain frequencies. The AR3000A is fitted with a switchable attenuator to help reduce the effects of signal overloading.

An internally switchable shortwave preamplifier (which is active only between 100kHz and 30MHz) is fitted into the AR3000A and is set to the 'On position' when leaving the factory. This makes the receiver extremely sensitive and ideal when connected to short lengths of wire.

Much better reception can be obtained by the connection of a long wire aerial, shortwave dipole or active aerial such as the WA5000.

In these cases it is better to switch the preamplifier Off in order to prevent overload due to the many strong signals present on the shortwave bands from mixing together in the receiver's circuitry.

To switch the preamplifier Off continue with the following:

Switch the receiver Off and disconnect from the power supply. Remove the bottom case then the top case (2 screws near the front feet and 4 screws on the rear of the receiver).

Locate the two small slide switches on the top printed circuit board. Both switches work together as a pair, slide them into the Off position. Reassemble the cases, connect the power supply and switch On.

If you are unfamiliar with modern circuit layout consult your dealer.
Do not touch and other part of the receiver, this will invalidate any warranty and could course serious damage.

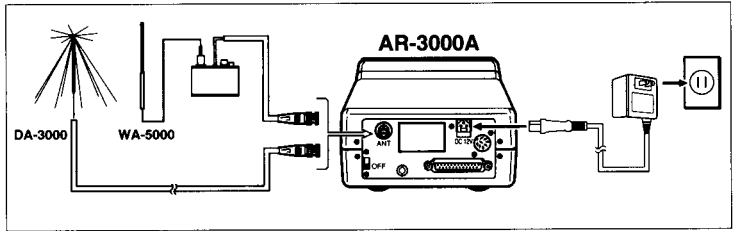

4-1 Legends on the LCD.

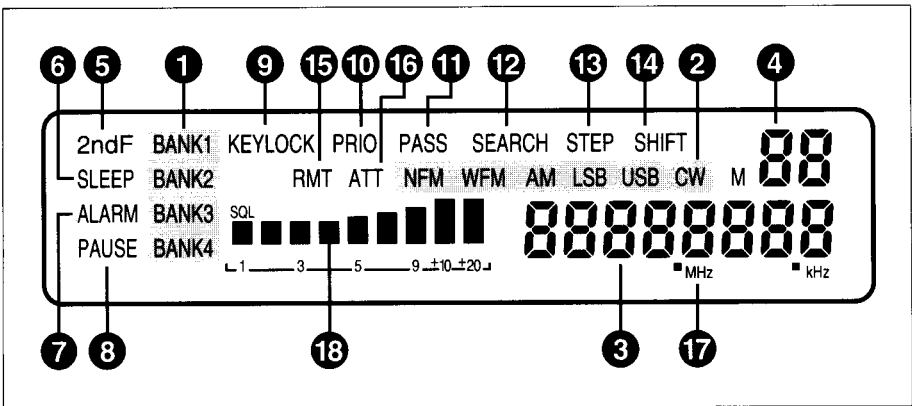

- | | |
|--|---|
| 1 <BANK (1,2,3,4)> display | 11 <PASS> display |
| 2 MODE <NFM> <WFM> <AM> <LSB> <USB> <CW> display | 12 <SEARCH> display |
| 3 Frequency display | 13 <STEP> Frequency (<x10mode>) display |
| 4 Memory display | 14 <SHIFT> display |
| 5 <2nd F> display | 15 <RMT> display |
| 6 <SLEEP> display | 16 <ATT> display |
| 7 <ALARM> display | 17 Slow tuning rate display |
| 8 <PAUSE> display | 18 Signal strength display |
| 9 <KEYLOCK> display | |
| 10 <PRIO> display | |

4-2 Front panel control functions.

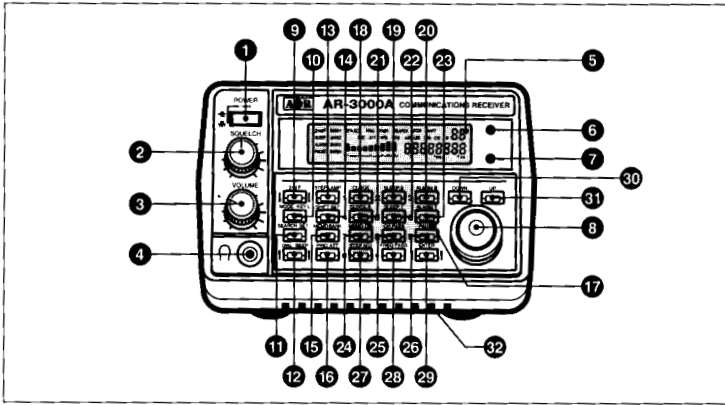

- | | |
|-------------------------------------|-----------------------------|
| 1 Power switch | 17 TEN key P12 |
| 2 Squelch control P27 | 18 1 key (CLOCK key P39) |
| 3 Volume control | 19 2 key (SLEEP key P41) |
| 4 Headphones (earphone) jack | 20 3 key (ALARM key P43) |
| 5 LCD unit | 21 4 key (CLOCK key P38) |
| 6 Step frequency x10mode key P12 | 22 5 key (SLEEP T key P40) |
| 7 Slow tuning rate key P12 | 23 6 key (ALARM T key P42) |
| 8 Main tuning knob P12 | 24 7 key (MEMO DEL key P39) |
| 9 2nd F key P11 | 25 8 key (CH PASS key P28) |
| 10 Mode key P11 (KEY. L P11) | 26 9 key (PAUSE key P35) |
| 11 SEARCH key P22 (SET key P22, 23) | 27 0 key (STEP ADJ key P33) |
| 12 Dial key P15 (BEEP key P11) | 28 . key (FREQ PASS key) |
| 13 STEP key P32 (LAMP key P11) | 29 ENTER key P12 |
| 14 SHIFT key P32 (SET key P34) | 30 DOWN key P12 |
| 15 MEMO key P26 (BANK key P11) | 31 UP key P12 |
| 16 PRIO key P30 (ATT key P11, 31) | 32 Built-in speaker |

* The functions shown inside brackets denote the secondary functions which can be activated by pressing the 2nd F key. For details of each function, please refer to the pages as indicated above.

Primary functions are printed in yellow/gold.
Secondary functions are printed in white.

9 - [2nd F] Second function key

Press this key and the <2nd F> indicator appears on the LCD.

The second function facility is activated when this key is pressed.

10 - [KEY L] Key lock key

This key is used to disable the operation of the keypad (to prevent accidental changes in operation such as frequency). This is a second function key, when the key lock is activated the <KEY L> indicator appears on the LCD. Repeat the sequence to cancel the keylock.

11 - [MODE] Mode key

This key is used to select the receiving mode. Available modes are: NFM, WFM, AM, LSB, USB & CW. When the mode key is pressed the LCD will blank except for the mode indicator. Press either the [UP] or [DOWN] keys until the desired mode is displayed (you may also rotate the main tuning control to select mode in place of the up/down keys). Press [ENTER] to complete the sequence and finalise mode entry.

12 - [BEEP] Beep key

Beep tones are used to confirm keypad operation and are emitted from a small beeper unit located on the reverse of the keypad. This is a second function key and may be used to turn the beep On and Off.

13 - [LAMP] Lamp key

Illumination is provided behind the LCD for areas of low level lighting. This is a second function key and may be used to switch the LCD back-light On and Off.

15 - [BANK] Bank key

This key changes the selected bank between bank 1, 2, 3 and 4.

This is a second function key, to operate press the [2nd F] key followed by [BANK], the <BANK> indicator on the LCD will start flashing. Press either the [UP] or [DOWN] key until the desired bank number is shown. Press [ENTER] to complete the sequence and finalise bank selection.

16 - [ATT] Attenuator key

The attenuator is a useful control designed to reduce the effect of signal overload when receiving strong signals. When the attenuator is switched On, the sensitivity of the receiver is reduced. This is a second function key, when the attenuator is activated, the <ATT> indicator will be shown on the LCD. Press this key to activate the attenuator, pressing a second time cancels the attenuator.

If this key is pressed and held for more than one second, the interval set mode is selected. (see page 31).

17 - Ten keys [0] to [9] and [.] keys

The ten keys are used to enter numeric information, i.e. receiving frequency, memory channel, frequency increment etc. The [.] key represents a decimal point at the MHz when entering a frequency and a kHz when entering a frequency step increment.

29 - [ENTER] key

This key is used to complete the information input sequences of receiving frequency, receiving mode, search/memory channel, shift-frequency and frequency increment.

30 - [DOWN] key

31 - [UP] key

Within the context of this manual, these two individual keys are literally placed together and described as [UP/DOWN] keys. Whenever the [Up/DOWN] keys appear as part of a keying sequence, either key may be used.

The [UP/DOWN] keys are used to manually step the receive frequency both forward or backward, depending on operational mode this is also true for memory channel stepping, receiving mode, search/memory banks and shift-frequency.

In DIAL mode, press and hold this key for more than one second to enter dial search mode.

Press the [MEMO] key then press the [UP/DOWN] key for more than one second to enter memory scan mode. (see pages 20 and 27 respectively).

6 - x10 key

Press this key to increase the frequency increment by a rate of ten (to a maximum of 995.95kHz). When activated the <STEP> indicator appears on the LCD. Press the key a second time to restore the normal frequency increment rate.

7 - Slow key

Press this key to reduce the frequency tuning rate by one fifth (to a minimum of 50Hz). When activated the (MHz) indicator disappears from the LCD. Press the key a second time to restore the normal frequency increment rate.

8 - Main tuning knob

The free running rotary tuning knob is used to select the receiving frequency, memory channel, bank and receiving mode. The rotary tuning control provides the very best method of user interface especially when tuning on the USB, LSB and CW receiving modes. The rotary tuning control is particularly useful when tuning around and locating receive signals while the [UP/DOWN] keys are More useful for selecting receiving mode and bank.

4-3 Rear panel controls and functions.

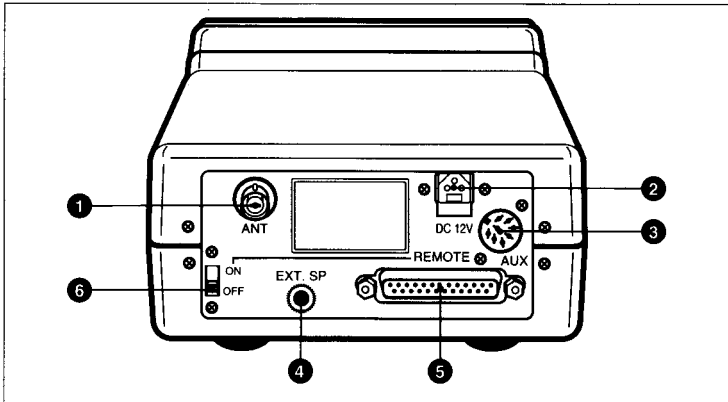
**1 - [ANT] Antenna (aerial) socket**

Connect an appropriate aerial (antenna) to this 50 OHM standard BNC socket. The telescopic whip aerial may be used for monitoring strong signals.

2 - [DC 12V] DC power input socket

The AR3000A is designed to operate only from a nominal 12V DC supply. Always use the supplied AC adaptor, or the supplied DC lead when used with a regulated 12V DC power supply or car battery. Never connect the receiver directly to the mains supply or serious damage may result with the added risk of personal injury. When using the DC lead, ensure correct connection polarity. RED is positive and BLACK is negative, failure to observe this could result in damage to the receiver.

3 - [AUX] DIN socket for tape recording (Page 45)

Connect a tape recorder to this 8 pin DIN socket.

4 - [EXT SP] External speaker socket (page 44)

The AR3000A is fitted with an internal loudspeaker unit. An external loudspeaker of 8 OHM impedance may be connected to this 3.5mm mono Jack socket, when connected the internal loudspeaker will be disabled.

5 - [REMOTE] RS232C Socket for PC remote control (Page 48)

The AR3000A may be controlled via a PC and other computers by connection to this 25 way 'D-type' socket.

6 - [ON/OFF] Remote On/Off switch

When this switch is turned on, all the functions of the AR3000A will be inoperative except for the On/Off power switch, volume control and squelch control even if a PC is not connected or switched on. When switched on, the AR3000A is expecting control via the RS232C remote connection.

(5) Operating the receiver.

(5) Operating the receiver.

5-1 Basic operation

- 1 Connect an appropriate aerial to the rear panel BNC aerial socket. The selection of the aerial depends upon your location and specific requirements. If in doubt please consult your dealer.
- 2 Connect the AR3000A to an appropriate DC power source using either the supplied AC adaptor or DC lead. Never connect the receiver directly to the mains supply.
- 3 Before turning On the power switch, set the volume control to the 10 o'clock position, the squelch to the 12 o'clock position and ensure the rear remote RS232C switch is in the Off position.
- 4 Turn On the power switch. Ensure none of the following descriptions are shown on the LCD when powered on for the first time:-
<KEYLOCK> (Page 20), <RMT> (Page 46) and <PAUSE> (Page 36).
Clear the descriptions from the LCD if displayed by referring to the respective pages as indicated above.

When the above procedure is complete the receiver is ready to accept frequency input and mode. As with an modern microprocessor controlled equipment, the AR3000A has enormous potential and capabilities. In order to achieve the maximum use of the receiver's performance and features, it is important to fully familiarise yourself with it's operation through the use of this handbook.

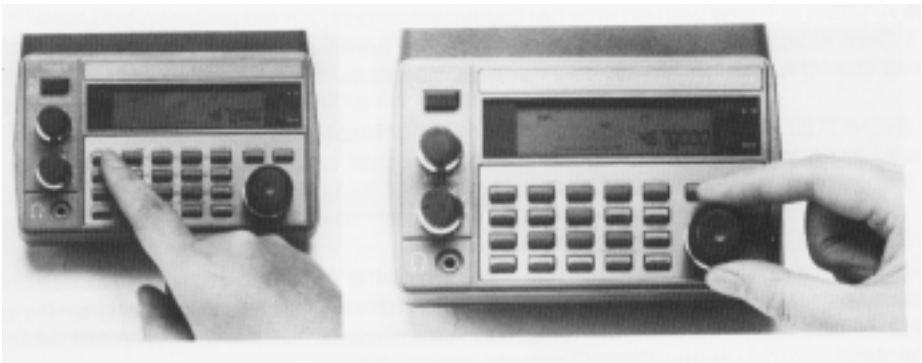

5-2 Operating modes.

(A) Dial mode.

In dial mode you may select frequencies for immediate listening. frequency entry is performed after pressing the [DIAL] key. Selection of receive frequency may be made by numeric entry via the 'Ten-keys', [UP/DOWN] keys or by rotating the main tuning knob.

A-1 Direct frequency entry via Ten-keys

Known specific receive frequencies may be directly entered via the Ten keys, this is particularly useful for already known frequencies such as BBC Radio 2 (88.3 MHz) etc.

Example 1:

Select the medium wave service of BBC Radio 1 on 1053kHz AM.

1 Press [DIAL]

2 Press [MODE]

Press [UP/DOWN] or rotate the main tuning knob until (AM) appears on the LCD. To accept the selection press [ENTER]. (Remember, always press [ENTER] to complete the keying sequence).

3 Press [STEP] [9] [ENTER] in that sequence.

This is not essential at this time, however as medium wave stations are allocated 9 kHz apart the receiver will be correctly set for further tuning of other stations using the main tuning knob (Page 32). If you wish to listen only to 1053kHz without further tuning around you may ignore this sequence.

4 Press [1] [.] [0] [5] [3] [ENTER] in that sequence.

The receiver is now correctly tuned to 1053kHz in AM mode.

* Always press [.] at the MHz eg. [.] [5] [9] [4] for 594kHz, finish the sequence by pressing [ENTER].

Press [4] [.] [7] [2] [2] [ENTER] for 4.722MHz.

If you make a mistake when keying in frequencies press [ENTER] and restart the sequence again.

(5) Operating the receiver.

Example 2:

Select a commercial airband frequency 133.7MHz AM.

1 Press [DIAL]

2 Press [MODE]

Press [UP/DOWN] or rotate the main tuning knob until (AM) appears on the LCD. To accept the selection press [ENTER].

3 Press [STEP] [2] [5] [ENTER] in that sequence.

This is not essential at this time, however it will select a channel spacing of 25kHz for the commercial airband, the receiver will be correctly set for further tuning of other stations using the main tuning knob (Page 32). If you wish to listen only to 133.7MHz without further tuning around you may ignore this sequence.

4 Press [1] [3] [3] [-.] [7] [ENTER] in that sequence.

The receiver is now correctly tuned to 133.7MHz in AM mode.

If you make a mistake when keying in frequencies press [ENTER] and restart the sequence again.

Example 3:

Select the VHF Band 2 service of BBC Radio 2 on 88.3MHz WFM.

1 Press [DIAL]

2 Press [MODE]

Press [UP/DOWN] or rotate the main tuning knob until (WFM) appears on the LCD. To accept the selection press [ENTER].

3 Press [8] [8] [-.] [3] [ENTER] in that sequence.

The receiver is now correctly tuned to 88.3MHz in WFM mode.

Example 4:

Select the 2m Amateur Band FM mobile calling frequency 145.5MHz NFM.

1 Press [DIAL]

2 Press [MODE]

Press [UP/DOWN] or rotate the main tuning knob until (NFM) appears on the LCD. To accept the selection press [ENTER].

3 Press [1] [4] [5] [.] [5] [ENTER] in that sequence.

The receiver is now correctly tuned to 145.5MHz in NFM mode.

Example 5:

Select the 40m Amateur Band 7.085MHz LSB.

1 Press [DIAL]

2 Press [MODE]

Press [UP/DOWN] or rotate the main tuning knob until (LSB) appears on the LCD. To accept the selection press [ENTER].

3 Press [STEP] [.] [0] [5] [ENTER] in that sequence.

This is to enter a very fine tuning step of 50Hz (0.05kHz) which is required for accurate tuning of SSB (USB, LSB & CW) in order to produce more natural sounding audio. The step size is entered as kHz so requires [.] prior to the step size selection when the figure is below 1 kHz.

Ignore this selection if you only wish to monitor one single frequency such as the European VOLMET weather transmission on 5.505MHz USB.

4 Press [7] [.] [0] [8] [5] [ENTER] in that sequence.

The receiver is now correctly tuned to 7.085MHz in LSB mode. You may now tune around the band using the main tuning knob, the step size is a fine 50Hz.

(5) Operating the receiver.

A-2 Manual tuning by the use of the main tuning knob.

This method of frequency selection is the most traditional approach to locating signals. It is often used when you wish to locate new or unknown frequencies or to check the activity within certain frequency bands such as Amateur bands or shortwave broadcast.

The control provides the very best 'user interface' with the receiver, the free running rotary main tuning control provides a smooth feel especially good for tuning in the SSB modes.

Note: In AM/USB/LSB/CW receiving modes, the squelch control will be automatically momentarily cancelled when the main tuning knob is rotated.

Example 1:

Tuning around the 20m Amateur Band on USB with a 50Hz step increment (tuning step size).

1 Press [DIAL]

2 Press [MODE]

Press [UP/DOWN] or rotate the main tuning knob until (USB) appears on the LCD. To accept the selection press [ENTER].

3 Press [STEP] [.] [0] [5] [ENTER] in that sequence.

This is to enter a very fine tuning step of 50Hz (0.05kHz).

4 Press [1] [4] [.] [1] [ENTER] in that sequence.

The receiver is now correctly tuned to the 20m Amateur band in USB mode with an increment of 50Hz.

5 You may now tune around the band by slowly rotating the main tuning knob. Rotate clockwise to increase the displayed frequency (and tunes the receiver upward), rotate anti-clockwise to decrease the displayed frequency (and tunes the receiver downward).

Turn the SQUELCH control fully anti-clockwise should the audio start to splutter or become intermittent.

Press the [x10] key to increase the frequency increment by a factor of 10 times (500Hz in this example). The (STEP) indicator will appear on the LCD when the function is selected. To return to a 50Hz increment press the [x10] key once again, the (STEP) indicator will disappear. The maximum selectable step size by any means is 995.95kHz.

The [x5] key will not function in this example as the smallest increment size of 50Hz is already selected. Depending whether you have selected USB or LSB the incoming tone will appear to increase or decrease with the clockwise or anti-clockwise rotation of the main tuning knob.

Example 2:

Tuning around the VHF commercial WFM band (88-108MHz) WFM.

- 1 Press [DIAL]
- 2 Press [MODE]
Press [UP/DOWN] or rotate the main tuning knob until (WFM) appears on the LCD. To accept the selection press [ENTER].
- 3 Press [STEP] [5] [0] [ENTER] in that sequence.
This is to select a 50kHz increment which is of most use in the VHF WFM band (the signals are very wide band).
- 4 Press [8] [8] [ENTER] in that sequence.
There is no need to use the [.] key is you are entering a frequency as a whole MHz.
- 5 You may now tune around the band by slowly rotating the main tuning knob. Rotate clockwise to increase the displayed frequency (and tunes the receiver upward), rotate anti-clockwise to decrease the displayed frequency (and tunes the receiver downward).

Turn the SQUELCH control fully anti-clockwise should the audio start to splutter or become intermittent.

Note: If you key in a frequency using the Ten-keys that is not devisable by the selected increment step, the receiver will not receive on the correct frequency if switched Off - On again.

(5) Operating the receiver.

(B) Dial search mode.

In dial mode, the receiver will automatically start searching for signals when the [UP/DOWN] key is pressed and held for more than one second.

The frequency increments are selectable in 50Hz steps between 50Hz and 995.95kHz.

Example 1:

Search from 594kHz upward with a 9kHz increment in AM mode.

1 Press [DIAL]

2 Press [MODE]

Press [UP/DOWN] or rotate the main tuning knob until <AM> appears on the LCD. To accept the selection press [ENTER]. (Remember, always press [ENTER] to complete the keying sequence).

3 Press [STEP] [9] [ENTER] in that sequence.

This is to set an increment of 9 kHz for the medium wave band.

4 Press [.] [5] [9] [4] [ENTER] in that sequence.

This places the receiver on the start frequency of 594kHz.

Always press [.] at the MHz eg. [.] [5] [9] [4] for 594kHz, finish the sequence by pressing [ENTER].

If you make a mistake when keying in frequencies press [ENTER] and restart the sequence again.

5 Press the [UP] key and keep it depressed for more than one second.

The <SEARCH> indicator will appear on the LCD and the receiver will start searching upward for signals. Should the receiver fail to search, rotate the SQUELCH control clockwise until the background noise is cancelled, this will enable the search facility to operate.

If you press the [x10] key, the <STEP> indicator will be displayed on the LCD and the search increment will be increased by a factor of 10 (to 90kHz in this example). Pressing the key a second time restores the original increment size.

If you press the [x5] key, the increment will be decreased by a factor of 5 (to 1.8kHz in this example). Pressing the key a second time restores the original increment size.

6 Press [DIAL] to stop searching. To restart the search press and hold the [UP/DOWN] key again.

Example 2:

Search on the 70cm (433MHz) Amateur band with a 25kHz increment in NFM mode.

1 Press [DIAL]

2 Press [MODE]

Press [UP/DOWN] or rotate the main tuning knob until <NFM> appears on the LCD. To accept the selection press [ENTER].

(Remember, always press [ENTER] to complete the keying sequence).

3 Press [STEP] [2] [5] [ENTER] in that sequence.

This is to set an increment of 25 kHz for the 70cm Amateur band.

4 Press [4] [3] [3] [ENTER] in that sequence.

This places the receiver on the start frequency of 433MHz.

If you make a mistake when keying in frequencies press [ENTER] and restart the sequence again.

5 Press the [UP] key and keep it depressed for more than one second.

The <SEARCH> indicator will appear on the LCD and the receiver will start searching upward for signals. Should the receiver fail to search, rotate the SQUELCH control clockwise until the background noise is cancelled, this will enable the search facility to operate.

If you press the [x10] key, the <STEP> indicator will be displayed on the LCD and the search increment will be increased by a factor of 10 (to 250 kHz in this example). Pressing the key a second time restores the original increment size.

If you press the [x5] key, the increment will be decreased by a factor of 5 (to 5kHz in this example). Pressing the key a second time restores the original increment size.

6 Press [DIAL] to stop searching. To restart the search press and hold the [UP/DOWN] key again.

(5) Operating the receiver.

(C) Program search mode.

There are four programmable search ranges in total, one in each of the four memory banks. Each search range may be programmed with start frequency, end frequency, increment (between 50Hz and 999.95kHz) and mode.

C-1 Frequency selection by program search

First you need to select a memory bank (1, 2, 3 or 4). To select memory bank 1 press [2nd F] [BANK] in sequence. Press the [UP/DOWN] key until <BANK1> is displayed on the LCD then press [ENTER] to accept the selection.

Example 1:

Program search on the commercial airband 118-138MHz using a 25kHz increment and AM mode.

- 1 Press [2nd F] [SEARCH SET] in sequence. The <SEARCH> indicator will appear and start flashing on the LCD. Press the [UP/DOWN] key until <AM> is displayed on the LCD then press [ENTER].
- 2 The <STEP> indicator should now be flashing on the LCD. Press [2] [5] [ENTER] to select an increment of 25kHz.
- 3 The <L> indicator will now appear on the LCD requesting entry of the low (start) frequency. Press [1] [1] [8] [ENTER] to select the start frequency.
- 4 The <H> indicator will now appear on the LCD requesting entry of the high (end) frequency. Press [1] [3] [8] [ENTER] to select the end frequency.

The <P> indicator appears on the LCD and the receiver automatically starts searching for signals. Should the receiver fail to search, rotate the SQUELCH control clockwise until the background noise is cancelled, this will enable the search facility to operate.

The search will stop when a signal is found. To restart the search while the signal is still present, either slightly rotate the main tuning knob or press the [UP/DOWN] key.

- 5 To stop the program search press [SEARCH]. To restart the program search press [SEARCH] again.

These parameters are now stored in the receivers memory, they are maintained by a battery backup so will not be lost even if you switch the set Off/On again.

To start a previously stores program search, select the appropriate memory band and press [SEARCH].

Example 2:

Program search on UHF 70cm Amateur band 433-434MHz using a 25kHz increment and NFM mode.

- 1 Press [2nd F] [SEARCH SET] in sequence. The <SEARCH> indicator will appear and start flashing on the LCD. Press the [UP/DOWN] key until <NFM> is displayed on the LCD then press [ENTER].
- 2 The <STEP> indicator should now be flashing on the LCD. Press [2] [5] [ENTER] to select an increment of 25kHz.
- 3 The <L> indicator will now appear on the LCD requesting entry of the low (start) frequency. Press [4] [3] [3] [ENTER] to select the start frequency.
- 4 The <H> indicator will now appear on the LCD requesting entry of the high (end) frequency. Press [4] [3] [4] [ENTER] to select the end frequency.

The <P> indicator appears on the LCD and the receiver automatically starts searching for signals. Should the receiver fail to search, rotate the SQUELCH control clockwise until the background noise is cancelled, this will enable the search facility to operate.

The search will stop when a signal is found. To restart the search while the signal is still present, either slightly rotate the main tuning knob or press the [UP/DOWN] key.

- 5 To stop the program search press [SEARCH]. To restart the program search press [SEARCH] again.

C-2 Set the delay time

The search and scan can be made to resume automatically using a predetermined delay in time from when the current signal disappears. The 'delay time' is adjustable between 0 and 9 seconds. This can be useful for monitoring different types of transmission especially simplex.

Example:

Set the delay time for 3 seconds

- 1 Press [2nd F] then press and hold the [SEARCH SET] for more than one second, the <DELAY> flashing indicator will appear on the LCD.
- 2 Press [3] [ENTER] in sequence to select a delay time of 3 seconds.

(5) Operating the receiver.

(D) Memory channel mode

The AR3000A has 400 memory channels (4 banks of 100 channels) which can store such information as receiving frequency, receiving mode, RF attenuator setting and lockout status. Memory contents are retained by a built-in lithium battery even if the receiver is switched off and disconnected from the power source.

D-1 Memory storage

The 100 memory channels are allocated in four banks, which are numbered as 00 to 99. Memory channel 00 is designated as 'priority channel' (See Page 30).

Example 1:

Store a keyed-in frequency of 150.85MHz NFM directly into memory channel 01 of bank 2.

- 1 Press [2nd F] [BANK] in sequence. Press [UP/DOWN] until the <BANK2> indicator is displayed on the LCD then press [ENTER].
- 2 Press [DIAL]
- 3 Press [MODE] Press the [UP/DOWN] key until the <NFM> indicator is displayed on the LCD then press [ENTER].
- 4 Press [STEP] [2] [5] [ENTER] in sequence to select a frequency increment of 25kHz (if you select an increment at this time, you may later tune from this frequency in dial mode with the desired increment already set).
- 5 Press [2nd F] [STEP ADJ] so that the <kHz> indicator on the LCD does not flash (repeat if necessary). This is a safe-guard to ensure the receiver will step through it's range with the correct frequency increment. (Page 33).
- 6 Press [1] [5] [0] [.] [0] [5] [ENTER] in sequence.
- 7 Press [ENTER] The <MCH> indicator will appear and flash on the LCD to confirm that the receiver is ready to accept memory channel data.

Should you wish to abandon the process press [DIAL] and the receiver will return to dial mode.

- 8 Press [0] [1] [ENTER] in sequence. The procedure is now complete. 150.825 MHz NFM has been stored into memory channel 01 of memory bank number 2.

Example 1:

Store a frequency picked up in search mode - 129.7MHz AM directly into memory channel 05 of the current memory bank.

For information regarding search mode see Example 1 on page 22 items 1 to 4.

Assuming the search has stopped at 129.7MHz

5 Press [DIAL] The (SEARCH) indicator should disappear from the LCD.

6 Press [ENTER] The (MCH) indicator will appear and flash on the LCD to confirm that the receiver is ready to accept memory channel data.

Should you wish to abandon the process press [DIAL] and the receiver will return to dial mode.

7 Press [0] [5] [ENTER] in sequence. The procedure is now complete. 129.7 MHz AM has been stored into memory channel number 05 of the current memory bank.

(5) Operating the receiver.

D-2 Memory channel recall

The idea of a memory channel is to enable you to quickly select and listen to a specific frequency previously stored. You may manually recall any channel from a memory bank by using the Ten-keys. The same function can be achieved through the use of the main tuning knob or [UP/DOWN] key.

Example 1:

Recall memory channel 01 of bank 2 by the Ten-key pad.

- 1 Press [2nd F] [BANK] in sequence. Press the [UP/DOWN] key until (BANK2) is selected on the LCD then press [ENTER]. This has selected memory bank number 2.
- 2 Press [0] [1] [MEMO] in sequence. this selects memory channel number 01. The selected frequency is now recalled and is monitored.

Example 2:

Use of the main tuning knob or [UP/DOWN] key to recall a memory channel.

- 1 Press [MEMO] this places the receiver into memory select.
- 2 Either rotate the main tuning knob or press the [UP/DOWN] key until the desired memory channel number is displayed on the left of the LCD. The memory channel may be monitored without further action.
- 3 If you wish to tune away from a memory channel press [DIAL] to revert the operation to dial mode. You may now use the main tuning knob or [UP/DOWN] key to tune the receiver.

You may choose to automatically search for active frequencies by placing the receiver into dial search mode. To enter dial search mode press [DIAL] then press and hold the [UP/DOWN] key for more than one second (Page 20).

(E) Memory channel scan mode.

The memory channels may be automatically scanned in order to quickly check for activity of known pre-programmed specific frequencies. Only one of the four memory banks can be scanned at a time (maximum of 100 memory channels). Memory channels which do not contain data will be skipped as will those which have been 'locked out'.

E-1 Adjust the squelch control

The adjustment of squelch is most important, it affects the operation of search and scan as well as making prolonged monitoring more comfortable. The squelch control can be considered as setting the level of signal required to stop the scan/search process and allow transmissions to be heard.

In the fully anti-clockwise position, the squelch is 'open' and no scan/search can take place. All levels of in-range transmission will be heard with background noise audible between transmissions.

Starting from the fully anti-clockwise position, rotate the control clockwise until the background noise from the speaker is just cut off. This is the most sensitive setting of the squelch control and is known as the 'threshold'. At this setting bursts of noise may stop the receiver from scanning or searching, for this reason it is advisable to slightly advance the squelch control to avoid this situation. The correct setting will be easily found by experience. This also applies to all other sections of this operating manual relating to the scan and search operations.

E-2 Scanning memory channels

Example:

Scan all active memory channels in memory bank 2.

- 1 Press [2nd F] [BANK] in sequence. Press the [UP/DOWN] key until (BANK?) is displayed on the LCD then press [ENTER]. This is to select memory bank number 2.
- 2 Press [MEMO] This selects memory recall.
- 3 Press and hold the [UP/DOWN] key for more than one second to start memory scan. the (M) indicator will flash on the LCD to remind you that you have entered memory scan mode.
- 4 Should the receiver stop scanning (or refuse to scan), press and hold the [UP/DOWN] key for more than one second to force the receiver to resume scan even if a signal is still present.
- 5 Press [MEMO] to cancel memory scan.

(5) Operating the receiver.

E-3 Memory channel pass (=lockout').

This facility allows you to temporarily remove a memory channel from the scan list without actually having to remove the data from the memory bank. This can be useful for temporarily removing continually active channels when you do not wish to monitor them.

Example 1:

Pass channels 01 and 05 from memory bank number 2.

- 1 Press [2nd F] [BANK] in sequence. Press the [UP/DOWN] key until <BANK2> is indicated on the LCD then press [ENTER]. This has selected memory bank 2.
- 2 Press [0] [1] [MEMO] in sequence to recall memory channel 01.
- 3 Press [2nd F] [CH PASS] in sequence. The <PASS> indicator appears on the LCD to show that channel number 01 has been 'locked out'.
- 4 Either rotate the main tuning knob or press the [UP/DOWN] key to select memory channel number 05.
- 5 Press [2nd F] [CH PASS] in sequence. The <PASS> indicator appears on the LCD to show that channel number 05 has been 'locked out'.

Memory channel 01 and 05 will now be locked out of memory bank number 2. These channels will now be 'skipped' when the bank is scanned.

To reinstate the memory channels, repeat the above process to remove the <PASS> indicators from the appropriate memory channels.

Example 2:

To cancel the lockout of channel 01 of memory bank 2.

- 1 Press [2nd F] [BANK] in sequence. Press the [UP/DOWN] key until <BANK2> is indicated on the LCD then press [ENTER]. This has selected memory bank 2.
- 2 Press [0] [1] [MEMO] in sequence to recall memory channel 01.
- 3 Press [2nd F] [CH PASS] in sequence. The <PASS> indicator disappears from the LCD to show that channel number 01 has been unlocked.

E-4 Erasure of memory contents.

The stored data may be erased from a memory using the following procedure:

First recall the memory channel onto the LCD then press [2nd F] followed by [MEMO.DEL]

Example:

Erase the memory content of channel 01 of bank 2.

- 1 Press [2nd F] [BANK] in sequence. Press the [UP/DOWN] key until (BANK2) is displayed on the LCD then press [ENTER]. this is to select memory bank 2.
- 2 Press [0] [1] [MEMO] in sequence to recall memory channel number 01.
- 3 Press [2nd F] [MEMO.DEL] in sequence to erase the memory contents.

It is also possible to clear all memory channels by resetting the microprocessor. Switch off the main power switch. Hold down keys [3] and [6] together, switch on the main power switch while holding keys [3] and [6]. Now release the keys, the microprocessor will reset. Memory banks 2, 3 and 4 will be cleared and memory bank 1 will be loaded with factory default frequencies. (Page 54).

(5) Operating the receiver.

(F) Priority channel

Memory channel number 00 of each memory bank is specially designated as Priority channel. As there are four memory banks, there are four priority channels in total.

F-1 Activating priority channel

In order to use the priority feature, memory channel 00 must first be programmed. You should store both the frequency and mode of a transmission you wish to 'keep an eye on' such as a distress frequency like 121.5MHz AM etc.

When you have stored an interesting frequency into memory channel 00, press [PRIO] once. The <PRIO> indicator will appear on the LCD and memory channel 00 will be automatically 'checked' for activity in a predetermined interval whether a signal is received or not. If no transmission is found on memory channel 00, the receiver will return where-ever it came from whether in search, scan or dial mode.

If the priority function locates a transmission on memory channel number 00, the receiver will remain on channel 00 until the transmission ends.

Further pressing of the [PRIO] key toggles the priority facility On/Off. If you wish to stay on memory channel 00 for continuous monitoring press [MEMO] once.

Remember, the AR3000A has four priority channels, one in each bank. Only the priority channel of the currently selected memory bank may be used.

Example:

Store 145.5MHz NFM in memory channel 00 for priority monitoring.

- 1 Press [MODE] Press the [UP/DOWN] key unit <NFM> is indicated on the LCD then press [ENTER]. This selects the mode.
- 2 Press [STEP] [2] [5] [ENTER] in sequence to select a frequency increment of 25kHz.
- 3 Press [1] [4] [5] [-] [5] [ENTER] in sequence to enter the desired frequency.

- 4 Press [ENTER] [0] [0] [ENTER] in sequence. This completes the entry of 145.5MHz NFM into memory channel 00.
- 5 Press [PRIO]. This selects priority operation, the <PRIO> indicator appears on the LCD to confirm that priority operation has been activated.
- 6 To cancel the priority channel mode, press [PRIO] again. Should you wish to monitor the priority channel continuously press the [MEMO] key.

F-2 Adjusting the interval time.

The time interval between each sampling (checking) of the priority channel can be programmed. The range is between 1 and 19 seconds. Should you choose a figure of 10, then memory channel 00 (the priority channel) will be sampled every 10 seconds.

Example:

To select an interval of 3 seconds.

- 1 Press [2nd F] then press and hold the [ATT] key for more than one second. The <P-int> indicator flashes on the LCD.
- 2 Press [3] [ENTER] to select a 3 second interval.

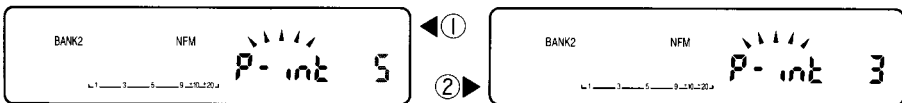

(5) Operating the receiver.

5-3 Function key

(A) [STEP] key.

The AR3000A provides selectable frequency increments for tuning and searching in 50Hz steps in the range of 50Hz to 999.95kHz. You should choose the most appropriate frequency increment according to the frequency band you wish to monitor. eg. 25kHz for VHF-UHF Amateur band, Airband and VHF Marine, 50kHz for VHF WFM etc.

Example 1:

Select a 12.5kHz increment (step).

- 1 Press [STEP] The <STEP> indicator appears and flashes on the LCD to confirm selection.
- 2 Press [1] [2] [.] [5] [ENTER] in sequence. Remember, a decimal point is entered at the kHz position.



Example 2:

Select a 50Hz increment (step).

- 1 Press [STEP] The <STEP> indicator appears and flashed on the LCD to confirm selection.
- 2 Press [.] [0] [5] [ENTER] in sequence. You will notice that a decimal point is inserted before entry at the kHz position.

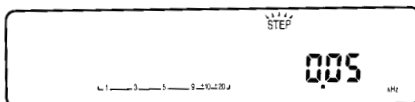

(B) [STEP ADJ] Step adjust key.

In search or dial mode, this facility enables the receiver to step in 'round increments' (such as 10kHz or 25kHz) but carry an odd trailing frequency offset. This can be useful for monitoring the UK CB FM frequencies which have a 10kHz increment but a 1.25kHz trailing frequency offset.

eg. The search is required to start from 27.6012 (which is the closest frequency you can enter from the keypad) and have a 10kHz increment... 27.6012, 27.6112, 27.6212, 27.6312 etc Also the cellular band uses a 25kHz increment but a 12.5kHz trailing frequency offset.

eg. The search is required to start from 935.0125MHz and have a 25kHz increment... 935.0125, 935.0375, 935.0625, 935.1125 etc

When this facility is disengaged, like most other receivers, the AR3000A will start searching in the specified increment but will cancel the trailing frequency offset.

eg. For cellular... 935.0125 then 935.025, 935.050, 935.075, 935.100 etc. i.e. reverting to the nearest 25kHz step.

Note: (a) If you disengage the step adjust facility before entering program search, you will have to reprogramme the program search again or change the increment in order to return to the correct trailing frequency offset.

(b) The [FREQ PASS] facility does not function when [STEP ADJ] is engaged.

Example 1:

Activate the step adjust facility starting from 100.01MHz in 25kHz steps using dial mode.

- 1 Press [STEP] [2] [5] [STEP] in sequence to select the step.
- 2 Press [2nd F] [STEP ADJ] in sequence to activate the step adjust facility. The (kHz) indicator of the LCD will flash to confirm operation.
- 3 Press [1] [0] [0] [.] [0] [1] [ENTER] to select the start frequency.
- 4 Either press the [UP/DOWN] key or rotate the main tuning knob. Frequencies will change as: 100.010, 100.035, 100.060, 100.085 etc.

Example 2:

To cancel the step adjust facility.

- 1 Assuming the step adjust facility is engaged as above press the [2nd F] [STEP ADJ] keys in sequence. The (kHz) indicator of the LCD stops flashing to confirm the facility has been disengaged.
- 4 Either press the [UP/DOWN] key or rotate the main tuning knob. Frequencies will change as: 100.010, 100.025, 100.050, 100.075 etc.

(5) Operating the receiver.

(C) [SHIFT] Shift key, [SHIFT SET] shift set key.

This facility is especially useful for monitoring duplex frequencies, this means two stations who communicate by simultaneous transmission on two different frequencies often using repeater stations. Examples are VHF Marine, public service, cellular and VHF-UHF Amateur radio.

Within each band, the offset is usually constant making it possible to pre-determine and pre-program the required frequency shift. This makes it possible to monitor both sides of a conversation by pressing just one key [SHIFT] to change frequency.

Example 1:

To shift - 0.6MHz (600kHz down) from the present frequency i.e. for 2m Amateur band reception of repeater input frequency.

- 1 Press [2nd F] [SHIFT SET] [DOWN] [.] [6] [ENTER] in sequence.
This sets the required offset quantity and direction of shift.
A decimal point is inserted at the MHz point.
- 2 Press [SHIFT] The <SHIFT> indicator appears on the LCD to confirm operation. The receive frequency has also moved downward by 0.6MHz.
- 3 Press [SHIFT] again to return to the original frequency. The <SHIFT> indicator disappears from the LCD to indicate the facility has been cancelled.

Should you wish to use the same shift offset and direction again, you need only press the [SHIFT] key when required.

Example 2:

To shift + 1.6MHz (1.6MHz upward) from the present frequency i.e. for 70cm Amateur band reception of repeater input frequency.

- 1 Press [2nd F] [SHIFT SET] [UP] [1] [.] [6] [ENTER] in sequence.
This sets the required offset quantity and direction of shift.
A decimal point is inserted at the MHz point.
- 2 Press [SHIFT] The <SHIFT> indicator appears on the LCD to confirm operation. The receive frequency has also moved upward by 1.6MHz.
- 3 Press [SHIFT] again to return to the original frequency. The <SHIFT> indicator disappears from the LCD to indicate the facility has been cancelled.

Should you wish to use the same shift offset and direction again, you need only press the [SHIFT] key when required.

(D) [PAUSE] Pause key.

This facility allows the receiver to resume search and scan using a pre-determined time delay (pause time) even if a receive signal is still present. This applies to the dial search mode, program search mode and memory channel scan mode. It is particularly useful for general monitoring off air traffic and for checking band occupancy.

D-1 Setting the pause time.

The programming of pause time can be selected by pressing the [2nd F] key followed by [PAUSE] , inputting a value between 1 and 60 seconds then pressing [ENTER]

Example:

Set a 3 second pause time.

- 1 Press [2nd F] then press and hold the [PAUSE] key for more than one second. The flashing (PAUSE) indicator appears on the LCD to confirm operation.

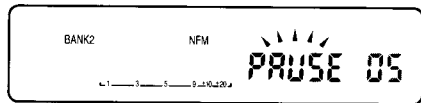

- 2 Press [3] [ENTER] in sequence to select the pause time in seconds. This completes the sequence and the flashing (PAUSE) indicator disappears from the LCD.

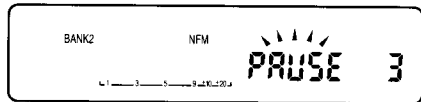

(5) Operating the receiver.

D-2 Activating the pause scan.

Pause scan (as described on page 35) can be activated by pressing the [2nd F] and [PAUSE] keys in sequence. The (PAUSE) indicator appears on the LCD accompanied by the decimal points at both the MHz and kHz alternatively flashing to confirm operation.

Example:

Activate the pause scan facility in memory scan mode (assuming a 3 second pause time already set. Page 35).

- 1 Press [2nd F] [PAUSE] in sequence. The (PAUSE) indicator appears on the LCD to confirm that the pause scan mode is ready to operate.
- 2 Press [MEMO] then press and hold the [UP/DOWN] key for more than one second. The (M) indicator appears on the LCD to confirm that the pause scan mode is engaged. The receiver stops on a busy channel and resumes scanning to the next busy channel even if the received signal is still present.

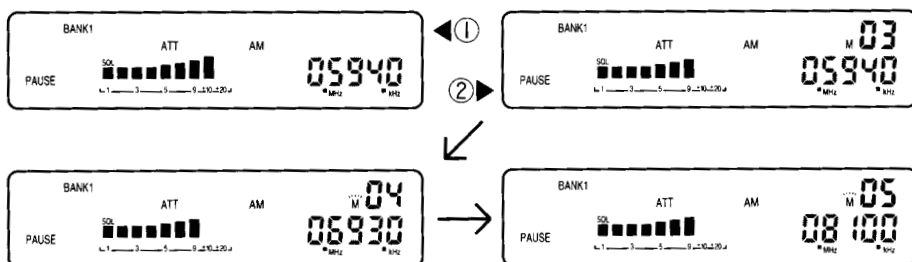

- 3 If you wish to continuously monitor a busy channel, you may temporarily disengage the pause scan mode by pressing [DIAL] once. To restart the pause scan mode press [DIAL] again.

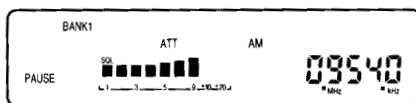

- 4 To cancel the pause scan mode completely, press [2nd F] [PAUSE] in sequence. The (PAUSE) indicator will disappear from the LCD and only memory scan mode will be engaged.

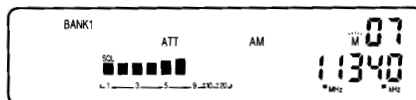

(E) [FREQ PASS] Frequency pass key.

This facility allows the receiver to bypass specific unwanted frequencies while in search mode. These may include continuously occupied channels, interference or spurs etc.

Up to 100 frequencies for each search bank may be specified in the frequency pass list giving a total of 400 channels. Please note however, this facility does not operate in direct tuning mode (dial mode) nor manual tuning mode nor when [STEP ADJ] mode is engaged.

E-1 Register frequencies to be bypassed.**Example:**

While in search mode, you may wish to bypass the currently displayed frequency on the LCD:

- 1 Press [2nd F] [FREQ PASS] in sequence. The receiver will automatically register the frequency into the pass list accompanied with a pass channel number which the AR3000A's microprocessor has randomly chosen (from channel 00 to 99).
- 2 Repeat this process up to 100 times for each search bank should you wish to bypass more than one specific frequency.

E-2 Recalling the pass frequencies.

All pass channels (frequencies registered as pass frequencies) may be displayed.

- 1 Press [2nd F] then press and hold the [FREQ PASS] key for more than one second. The <PASS> indicator flashes on the LCD to confirm operation.
- 2 Keep pressing [ENTER] to scroll through all the pass channels.
- 3 Press [DIAL] to escape from this review mode.

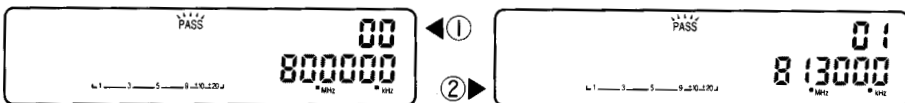

(5) Operating the receiver.

E-3 Deleting pass frequencies.

Frequencies may be deleted from the pass list one channel at a time.
To delete a pass channel:

- 1 Press [2nd F] then press and hold the [FREQ PASS] key for more than one second. The <PASS> indicator flashes on the LCD to confirm operation.

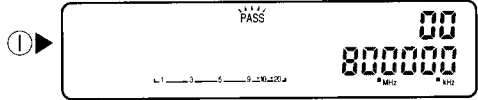

- 2 Keep pressing and releasing the [ENTER] key until the chosen frequency (pass channel) to be deleted is shown.
- 3 Press [0] [ENTER] to delete the presently displayed pass channel. The next pass channel appears on the display.

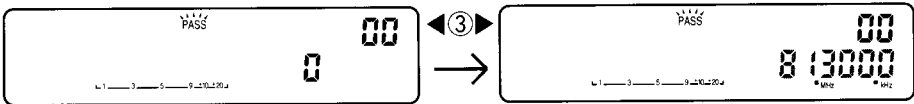

- 4 Repeat items 2 and 3 above to delete any other pass channels you wish to delete.
- 5 Finally press [DIAL] to escape from this mode.

E-4 Registering pass frequencies from the Ten-keys.

If you already know specific frequencies to be bypassed, you may register them to be bypassed by using the Ten-key pad.

- 1 Press [2nd F] then press and hold the [FREQ PASS] key for more than one second. The <PASS> indicator flashes on the LCD to confirm operation.
- 2 Keep pressing and releasing the [ENTER] key until you locate a frequency of 0.000.0, which suggests an empty pass channel.
- 3 Enter a frequency which you want to bypass e.g. 1.59MHz, press [1] [.] [5] [9] [ENTER] in sequence.

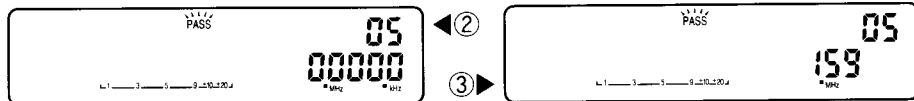

- 4 Repeat items 2 and 3 if you have more frequencies to be bypassed.
- 5 Finally press [DIAL] to escape from this mode.

(F) Clock facility

A 24-hour real time has been built into the AR3000A. This enables accurate log keeping and provides timing for the automatic timer switch-on and sleep facilities.

The LCD shows the time when selected and defaults to displaying the clock when the power switch is off but the power supply still connected and powered. The time is retained (but not shown) when the mains supply is switched off by a built-in lithium battery backup.

F-1 [CLOCK S] Clock time set key.

This key is used to enter the present time. Accurate time setting is available by referring (listening) to the WWV signals or time checks from radio programmes.

Example 1:

Set the clock at 20h 40m 00s while listening to a WWV signal.

- 1 Press [DIAL] [MODE] in sequence. Press [UP/DOWN] until (AM) is indicated on the LCD then press [ENTER]. This has selected dial mode and AM receiving mode.
- 2 Press [1] [0] [ENTER] in sequence assuming you are wishing to listen to the 10MHz WWV signal.
- 3 Press [2nd F] [CLOCK S] in sequence. This prepares the receiver for time input. The decimal points between hours, minutes and seconds flash to confirm selection.
- 4 Press [2] [0] [4] [0] [0] [0] in sequence. This selects at time of 20h 40m 00s. Press [ENTER] when WWV announces 20h 40m 00s. The clock starts to increment second by second to show the time is set and the clock is running.
- 5 Finally press [DIAL] to escape from this mode.

Example 2:

Set the clock at 07h 05m 30s through the Ten-keys.

- 1 Press [2nd F] [CLOCK S] in sequence.
- 2 Press [0] [7] [0] [5] [3] [0] [ENTER] in sequence.
- 3 Press [DIAL] to escape from this mode.

(5) Operating the receiver.

F-2 [CLOCK] Clock display key.

This key is used to call the present time to the LCD while receiving signals.

- 1 Press [2nd F] [CLOCK] in sequence. The present time is shown on the LCD in place of the frequency. All the information other than frequency remains displayed on the LCD.
- 2 Press [DIAL] to escape from this mode.

(G) Sleep timer facility.

The timer facility enables the receiver to switch off automatically after a predetermined length of time (between 1 and 120 minutes).

Sleep time set and sleep set functions are used to control the sleep timer facility. To operate this facility, first program the length of time required then set the sleep on.

G-1 [SLEEP T] Sleep time set key.

This key is used to register the length of time used by the receiver before switching off using the sleep function. The selectable range is programmed in minutes, the range being from 1 to 120 minutes.

This value remains effective until another timing is registered.

Example:

Set the sleep time to 30 minutes duration.

- 1 Press [2nd F] [SLEEP T] in sequence. The (SLEEP) indicator appears on the LCD to confirm operation.
- 2 Press [3] [0] [ENTER] in sequence.

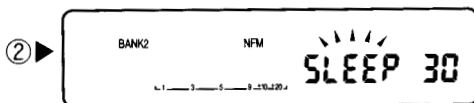

G-2 [SLEEP S] Sleep set key.

This key is used to activate the sleep time facility.

- 1 Press [2nd F] [SLEEP S] in sequence. The (SLEEP) indicator appears on the LCD to confirm operation.

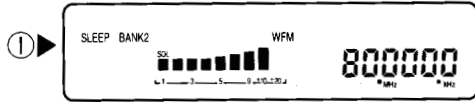

- 2 Turn the power switch off. The receiver continues to operate until the set timing has elapsed.

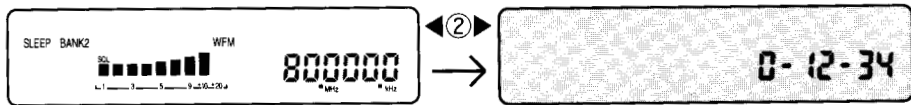

- 3 To cancel the sleep time facility, press [2nd F] [SLEEP S] in sequence. The (SLEEP) indicator will disappear to confirm the facility has been cancelled.

* If the power supply is removed from the receiver while the sleep time facility is engaged (such as a mains power cut), the receiver will remain switched off even if the power is restored.

(5) Operating the receiver.

(H) Alarm facility.

The alarm facility enables you to switch on the AR3000A at a preset time. To activate this facility first program the time at which the receiver is to switch on. Press the alarm On/Off key once and turn the power switch off. When the preset time has arrived, the receiver will switch on and monitor the frequency and mode displayed before switch-off.

H-1 [ALARM T] Alarm time set key.

This key is used to register the alarm switch on time using a 24-hour display.

Example 1:

Register an alarm switch on time of 06h 30m.

- 1 Press [2nd F] [ALARM T] in sequence. The decimal points between hours and minutes flash to confirm operation.
- 2 Press [0] [6] [3] [0] [ENTER] in sequence. This represents hours and minutes. seconds are not used. The alarm time is now registered.

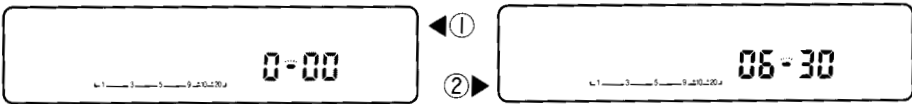

Example 2:

Register an alarm switch on time of 22h 05m.

- 1 Press [2nd F] [ALARM T] in sequence. The decimal points between hours and minutes flash to confirm operation.
- 2 Press [2] [2] [0] [5] [ENTER] in sequence. This represents hours and minutes. seconds are not used. The alarm time is now registered.

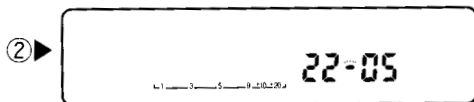

H-2 [ALARM S] Alarm set key.

This key is used to activate the alarm facility. When the preset time has arrived, the receiver will switch on and monitor the frequency and mode displayed before switch-off. Tune the receiver to the frequency and mode you wish to monitor before the alarm facility is activated.

Note: If you key in a frequency using the Ten-keys that is not devisable by the selected increment step, the receiver will not receive on the correct frequency when the alarm facility switches on.

- 1 Press [2nd F] [ALARM S] in sequence. The (ALARM) indicator appears on the LCD to confirm operation.

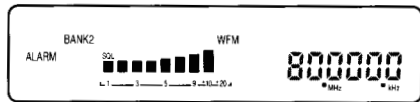

- 2 Turn the receivers power switch Off. All LCD information will be extinguished except for the (AL) indicator to show the facility has been engaged.

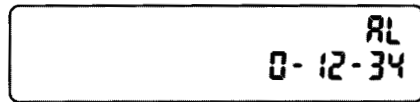

- 3 When the preset time has been reached, the receiver will automatically switch On using the last frequency and mode used.

The audio volume output is higher than normal when the alarm facility has switched on and the receiver and the front panel control will not operate. The receiver will be automatically switched off after 60 minutes unless the alarm facility is disengaged.

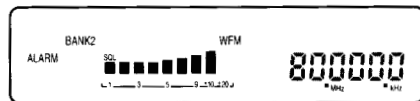

Should you wish to manually tune the receiver or reduce the volume level, switch the main power switch On then Off then On again.

- 4 To disengage the alarm facility, first turn the power switch On, then press [2nd F] [ALARM S] in sequence. The (ALARM) indicator disappears from the LCD to show the function has been cancelled. The receiver returns to normal operation including the audio volume output.

(6) Useful tips for operating the AR3000A.

(6) Useful tips for operating the AR3000A.

The AR3000A is equipped with useful sockets both on the front and rear panels to provide the maximum flexibility of operation. Optional accessories are also available to complement the AR3000A and further add to its versatility.

6-1 Using headphones and earphone.

The front panel earphone connection provides a reduced output level which is ideal for an earphone or small headphone. The earphone output uses a 3.5mm Jack socket, the earphone impedance should be 8 to 16 OHM. Use of this socket disables both the internal and any externally connected loudspeaker.

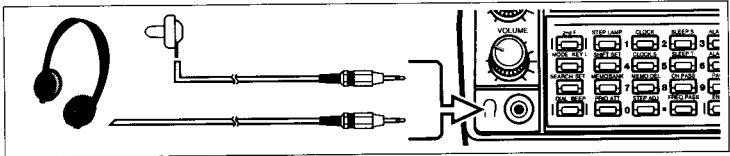

6-2 Using an external loudspeaker.

The AR3000A is fitted with an internal loudspeaker unit. An external loudspeaker of 8 OHM impedance may be connected to the rear panel mono 3.5mm Jack socket. When connected the internal loudspeaker will be disabled. The centre 'tip' pin is the positive audio feed and the outer 'body' is ground.

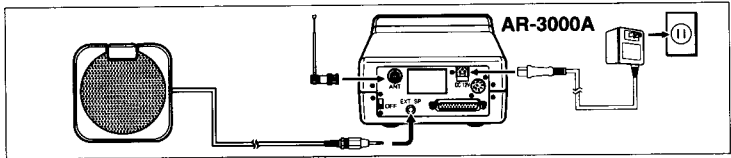

6-3 Automatic tape recording.

The rear panel AUX socket is of an 8 pin round DIN type and is provided for connection to a tape recorder. An optional lead (CR400) is available for connection to a tape recorder but an equivalent may be made or supplied by your dealer.

The lead connects between the AUX socket of the AR3000A and the 3.5mm microphone input and 2.5mm remote switch input of a suitable tape recorder. The AR3000A assumes the tape recorder to have a transistor switched input stage.

The tape recorder will be automatically activated when a signal is received by the AR3000A and the squelch opens. This facility is especially useful for monitoring various transmissions while the receiver is unattended.

Tape recorders demanding an independent relay switch or VOX may require an additional interface or modification. your dealer may be able to help you with connection. The AUX audio output is not controlled by the squelch, if there is no signal present 'noise' will be sent to this connection. Only the remote switch contacts (pins 6 & 7) are switched by the squelch.

On certain tape recorders the polarity of pins 6 and 7 will need to be reversed after carefully checking polarity.

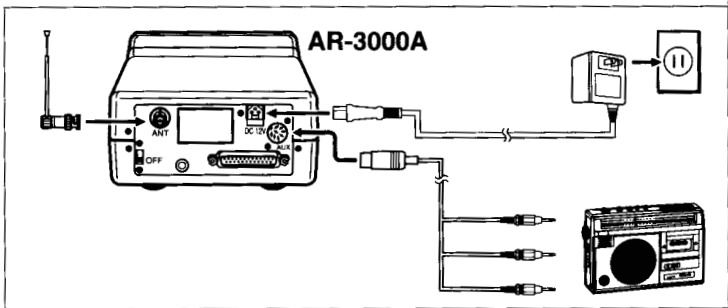

Equipment required.

AR3000A

Suitable tape recorder with remote socket

CR400 connecting lead with DIN socket (or equivalent)

8 pin DIN socket

Pin 4 Audio output Pin 2 Audio ground Pin 6 Switched output

Pin 7 Switched output Pin 5 is a further reduced level audio output.

(6) Useful tips for operating the AR3000A.

6-4 Receiving news and weather facsimile transmissions.

Most of these re-transmission services operate on the shortwave and lower frequency bands between 130kHz and 30MHz. In particular weather facsimile services (often referred to as WEFAX) are transmitted by most countries on numerous frequencies with great regularity. Many frequency books are available so locating a transmission should not be a problem.

Connect a specialist facsimile decoder/printer (such as the AOR WX-2000) to the speaker output of the AR3000A and increase the volume control to the 11 o'clock position. Connect a long-wire aerial or active wide band aerial (AOR WA5000) to the BNC aerial input socket. If you use a long-wire aerial only the centre connection need be made.

The FM method of WEFAX transmission is most popular on these bands. The AR3000A should be tuned to USB or LSB and a very fine tuning step of 50Hz used. Should the picture appear in reverse video (Black on white when it should be white on black or visa versa) then swap from USB to LSB or LSB to USB and retune the receiver.

Equipment required.

AR3000A

External aerial WA5000

Radio facsimile decoder/printer WX-2000

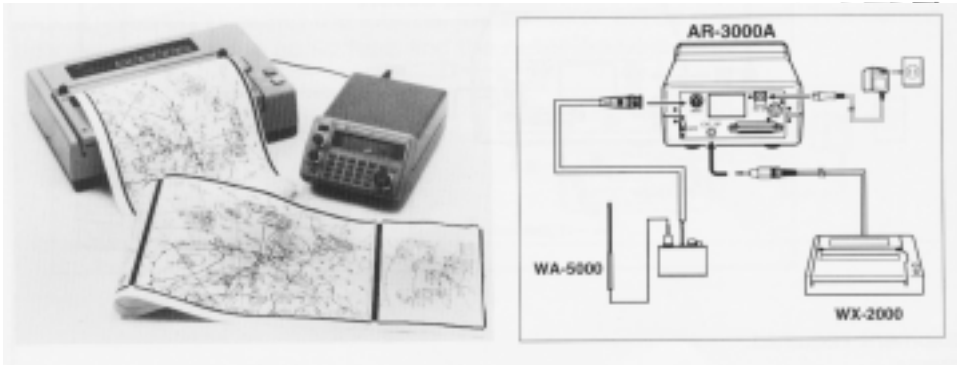

6-5 Direct reception from weather satellites.

It is possible to receive direct transmission from orbital and geostationary satellites such as METEOR etc. The orbital satellites use the frequency band around 137.5MHz while the geostationary services found around 1691MHz. The common mode is AM requiring the AR3000A to be tuned to WFM !

Due to the weak signals provided at these frequencies, a highly directional, high gain aerial will be required such as the parabolic AOR DA1000. A low noise amplifier will almost certainly be required in order to achieve satisfactory results (AOR LA3000). A suitable facsimile decoder/printer will also be required such as the AOR WX-2000.

Equipment required.

AR3000A

Parabolic aerial DA1000

Low noise amplifier LA3000

Radio facsimile decoder/printer WX-2000

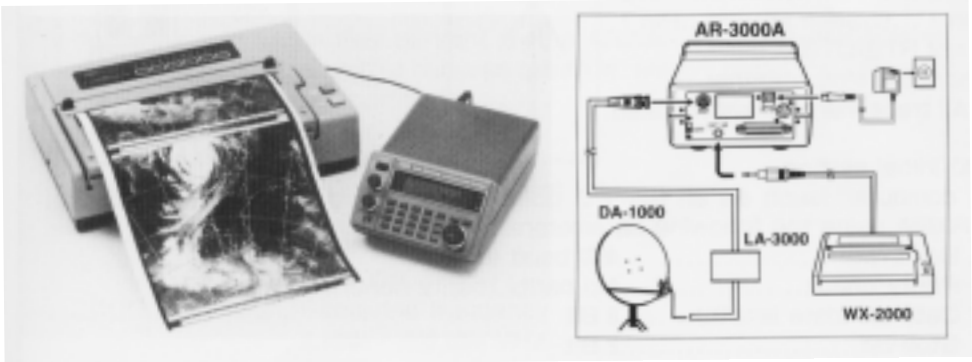

(6) Useful tips for operating the AR3000A.

6-6 Computer control.

The AR3000A has a built in RS232C computer control port allowing two way communication of data between the AR3000A and computer. As a minimum requirement, the computer must be capable of operating as a communications terminal via it's own RS232C port.

Equipment required.

- 1 AR3000A
 - 2 External aerial (eg. DA3000, WA5000) essential in order to reduce the level of computer generated noise from entering the receiver.
 - 3 Personal computer running in terminal mode.
 - 4 RS232C connecting lead (straight type, not null modem).
- RS232C pin connections for an IBM-PC or compatible:

AR3000A		IBM-PC
Pin 1 ...Frame ground....		Pin 1
Pin 2 ...TX data.....		Pin 2
Pin 3 ...RX data.....		Pin 3
Pin 4 ...RTS.....		Pin 4
Pin 5 ...CTS.....		Pin 5
Pin 7 ...System ground...		Pin 7

If not RTS/CTS is used, short the pins together.
 *All trade marks acknowledged.

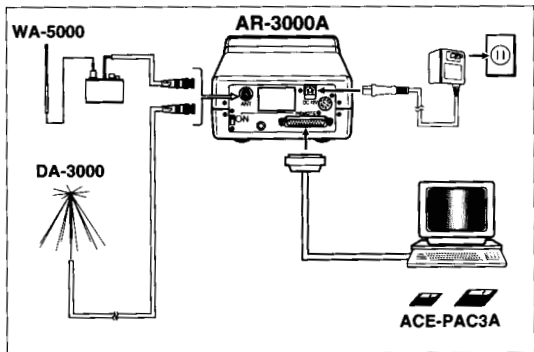

(A) Initial setting.

A computer (such as an IBM-PC compatible) should be connected to the AR3000A using the following parameters:

- 1 Baud rate.....4800 baud (bps)
- 2 Parity check.....No parity (parity none)
- 3 Data bit (data length).....8 Bit
- 4 Stop bit.....2 Bit
- 5 X parameter.....Void

The internal baud rate of the AR3000A may be increased from 4800 baud to 9600 baud by the use of a small internal slide switch. If you are not familiar with the internal layout of modern equipment ask your dealer to move the switch should you need to change the speed. Switch Off the receiver and disconnect the power supply. The slide switch is located on the reverse of the keypad in the top left hand corner, it is coloured grey. To access the switch you will need to remove the bottom case of the AR3000A, to improve access it is also advisable to remove the top case as well. The switch has two positions, note the current position (4800 baud) and carefully slide the switch to the new position. Reassemble the cases, connect the power supply and switch on the receiver. Do not touch any other area of the receiver as this will invalidate any warranty and could damage the receiver.

(B) Starting RS232C mode.

After the initial setting has been carried out, switch the AR3000A remote switch On. An opening 'welcome' message will appear on the computer screen and at the same time the (RMT) indicator appears on the LCD of the AR3000A to confirm operation.

The AR3000A is now inoperative except for the power switch, squelch control and volume control. A ready prompt [>] appears on the computer screen to indicate the AR3000A is ready to accept input via computer control. Always ensure the ready prompt is received before entering further information.

```

*****
* HELLO RS232C CONNECTED *
*                               *
*   -- JUNE . 1990 --   *
*****
>

```

(C) Input commands.

The following commands may be sent to the AR3000A via computer control. Always follow a command with a carriage return ie. always press the computer [CR] [RETURN] after each command.

```

[] [] M...Memory channel (00 - 99)
[] [] . [] [] S...Frequency increment (step)
          0.05 - 999.95 kHz
R...ATT On
T...ATT Off
[] [] [] . [] [] [] []...Receiving frequency
          0.10000 - 2036.0000 MHz
N...NFM mode
W...WFM mode
A...AM mode
L...LSB mode
U...USB mode
C...CW mode
[] [] [] . [] [] [] [] Q...Pass frequency (MHz)
  [] X...Bank number (1 - 4)
  [] [] Z...Recall memory channel number (00 - 99)
  [] [] J...JIG input used for testing
  E...Set mute-out
  F...Reset mute-out
  G...Squelch Mute-out auto On/Off by squelch

```

(6) Useful tips for operating the AR3000A.

(D) Entering data via the computer.

Data should be entered in the following sequence:

[M-CH]→[STEP frequency]→[ATT On /Off]→[Receiving frequency]→[MODE]

Input examples.

- 1 128.8A[CR].....Enter 128.8MHz AM mode
- 2 1.9075C[CR].....Enter 1.9075MHz CW mode
- 3 R 80W[CR].....Enter ATT On 80MHz WFM mode
- 4 20.S T 150.85N[CR].....20 kHz frequency increment,
ATT Off, 150.85MHz NFM mode
- 5 01M 10.S T 144.N[CR].....Channel 01, 10kHz frequency
increment, ATT Off, 144MHz NFM mode
- 6 99M .05S T 21.U[CR].....Channel 99, 0.05kHz frequency
increment, ATT Off, 21MHz USB mode
- 7 1.59Q [CR].....Pass 1.59MHz
- 8 2X [CR].....Move to Bank 2
- 9 01Z [CR].....Recall channel 01

Remarks.

- 1 Although they may be entered separately, it is a good idea to enter the receiving frequency and mode together, the receiving mode must follow the receiving frequency.
- 2 Always enter data in the correct sequence. Setting the ATT On/Off may be placed anywhere in the sequence providing it is followed by [MODE].
- 3 You cannot enter data into a memory channel which has not been registered.
- 4 The present setting is valid if no data is newly entered for frequency increment.
- 5 The present setting is valid if no data is newly entered for ATT On/Off.
- 6 The present setting is valid if no data is newly entered for Receiving frequency.
- 7 The present setting is valid if no data is newly entered for Bank.
- 8 The system operates in Memory Channel Mode when the memory channel is set, otherwise the system operates in Dial Mode.
- 9 If you try to recall a particular memory channel where no data is stored, the system will advance to the next channel where data is stored.

(E) Output data.

You may display various receiving status on the computer screen by using the following commands. Always use a carriage return after entering each command, ie. always press the [CR] [RETURN] key of your computer after each command.

Output commands.

Z...Display the contents of the memory channel (00-99). Only the memory channels with correctly stored information will be displayed.

D...Displays the contents of Dial Mode.

P...Displays the contents of Pass channels (00-99). Only the Pass channels with correctly stored information will be displayed.

Y...Displays the signal strength reading.

The first 16 letters of the alphabet are used from A [lowest] to P [highest] in 16 steps. When the squelch is closed a % sign is displayed.

Format of output data from the commands [Z] and [D].

M-CH	JIG	ATT	STEP Frequency	Receiving Frequency	MODE
#--	J 0	W(ON) X(OFF)	Z--- -- (kHz)	Y----- (MHz)	Q(NFM) R(WFM) S(AM) T(LSB) U(USB) V(CW)

* M-CH data will not be displayed by the [D] command.

* JIG data is always displayed as 0.

* JIG data is used only for factory alignment / adjustment purposes.

* The IBM-PC based ACEPAC-3A multi-function remote control software is an option designed to further increase the versatility of the AR3000A. The software provides additional memory channels, advanced search / scan facilities and a spectrum analysis type display which can provide detailed information regarding band occupancy which may be printed out.

(7) Specifications.

(8) Specifications.

Receiver coverage	100kHz~2036MHz
Receiver mode	USB, LSB, CW, AM, NFM, WFM
Frequency selection	Dial mode/Dial search mode/Program search mode/ Memory channel mode/Memory scan mode/Priority channel mode
Frequency increment	Any multiple of 50Hz between 50Hz and 999.95kHz
Receiver circuitry	Triple (USB, LSB, CW, AM, NFM) quintuple (WFM) conversion superhetrodyne
Memory channels	400 channels (100 channels x 4 banks)
Search banks	4 programmable by user
Frequency lockout	100 per search bank - 400 total
Search/Scan modes	Variable hold 1 - 19 seconds
Variable pause	1 - 60 seconds
Priority channels	4 total (one in each memory bank)
Priority sampling	Programmable 1 - 9 seconds
Search/Scan speed	50 increments per second maximum (30 typical)
Receiver sensitivity	100kHz - 2.5MHz 10 dB S/N 1.0uV SSB 3.2uV AM 2.5 MHz - 1.8 GHz 10 dB S/N 0.25uV SSB 1.0uV AM 12 dB SINAD 0.35uV NFM 1.0uV WFM 1.8 GHz - 2.0 GHz 10 dB S/N 0.75uV SSB 3.0uV AM 12 dB SINAD 1.25uV NFM 3.0uV WFM
Receiver selectivity	USB, LSB, CW 2.4 kHz/-6dB, 4.5 kHz/-60dB AM, NFM 12kHz/-6dB, 15kHz/-70dB WFM 180kHz/-6dB, 800kHz/-50dB
Aerial connection	One BNC socket
Audio output	1.2 Watts into 4 OHM load @ 10% distortion 0.7 Watts into 8 OHM load @ 10% distortion
Display	Liquid crystal (LCD)
Memory backup	Internally fitted lithium battery (Solder type CR-203)
Dimensions	138mm (W) x 80mm (H), x 200mm (D)
Weight	1.2kg approx
Frequency stability	±5ppm (-10 to +50 Celsius)

Specifications and features are subject to change without notice due to continuous development.

Supplied accessories.

AC adaptor, DC lead, Telescopic whip aerial, Operating manual.

(8) References.

8-1 The receiver's internal spuri signals.

Due to the characteristics of superhetrodyne receiver circuits as used in the AR3000A, this receiver (like all other receivers) suffers from a degree of internally generated noises known as spuri.

The frequencies listed here are some of the frequencies that may not be received by the AR3000A. If entered into the pass channels, they will not be searched and the receiver will not stop on them. (Page 34 E-4)

1.59MHz	89.6 MHz	140.34MHz	400.78MHz
3.18MHz	96.0 MHz	153.6 MHz	430.78MHz
12.58MHz	102.4 MHz	170.36MHz	460.8 MHz
16.78MHz	108.8 MHz	200.38MHz	
20.97MHz	115.2 MHz	230.4 MHz	
76.8 MHz	123.58MHz	370.74MHz	

8-2 Signal strength meter reading (S-meter).

The receive signal strength is displayed on the LCD by a 9-segment bar graph. The approximate signal strength is as follows:

1.....	1.0 uV
7.....	30 uV
9.....	300 uV

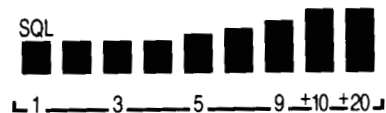

8-3 Default settings.

The default settings as from the factory are as follows, of course they may differ when shipped due to quality control testing.

* Frequency display	80.000 MHz
* Receiving mode	WFM
* Frequency increment	50.00kHz (Page 22)
* Shift frequency	0.0000MHz (Page 23)
* Pause time	5 seconds (Page 24)
* Delay time	2 seconds (Page 17)
* Interval time	5 seconds (Page 31)

(8) References.

8-4 Resetting the microprocessor.

(A) Reset the microprocessor clock while retaining the memory contents.

- 1 Turn the power switch Off.
- 2 Press and hold the [3] key and turn the power switch On. Release the [3] key.

(B) Reset the microprocessor erasing all memory contents.

- 1 Turn the power switch Off.
- 2 Press and hold both the [3] and [6] keys and turn the power switch On. Release both the [3] and [6] keys.

The receiver will power up with the factory defaults as indicated in section 8-3.

(C) Total microprocessor reset (internal).

If you are not familiar with modern circuit board layout seek advice from your dealer.

- 1 Switch the power Off and disconnect the power supply.
- 2 Remove both the bottom and top covers in that sequence. (Remove the two screws near the front feet and the 4 screws from the rear case).
- 3 With the covers removed, reconnect the power supply.
- 4 Switch the power switch On.
- 5 Press the grey reset button located on the reverse of the keyboard in the top right hand corner (next to the grey computer baud rate slide switch).

The receiver will power up with the factory defaults as indicated in section 8-3.

- 6 Switch the AR3000A Off and remove the power supply.
- 7 Reassemble the case and reconnect the power supply.

Do not touch any other area of the receiver as this will invalidate any warranty and could damage the receiver.

(9) Troubleshooting.

Before returning your receiver for repair please check the following:

1 No power.

- * AC plug is firmly connected to the mains socket and the fuse has not blown.
- * DC lead (if used) is correctly connected.
- * The power connection polarity is correct.

2 No audio output.

- * The power switch is turned On.
- * The volume control is properly used.
- * Background noise is audible when the squelch control is turned fully anti-clockwise.
- * If a headphone, earphone or external loudspeaker is used, check that it is correctly fitted into the appropriate socket.

3 Poor sensitivity.

- * If the <ATT> indicator is shown on the LCD then the sensitivity will be reduced. To disengage the attenuator press [2nd F] [ATT] in sequence.
- * Check the aerial is correctly connected. The coaxial cable may be faulty or short circuited (maybe in the connector).
- * The aerial may be miss-matched and unsuitable.

4 Does not operate properly with from the keypad.

- * The keylock <KEY L> (Page 11) or remote <RMT> (Page 48) indicators are displayed on the LCD. Refer to each page to disengage these facilities.
- * Try pressing [DIAL] prior to the keying sequence.
- * Turn the squelch control fully clockwise if the search or scan refuses to operate.

(10) Optional accessories.

(10) Optional accessories.

* DA3000 wide band disccone aerial 25~2000MHz.

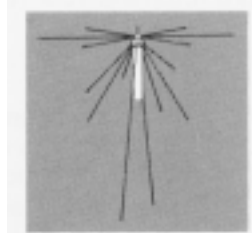

* WA5000 active wide band compact aerial 30kHz~2000MHz.



* MA500 mobile whip aerial.

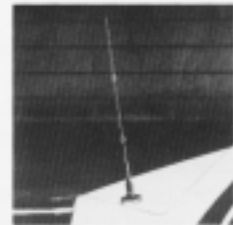

* MM1 quick release mobile mounting bracket.

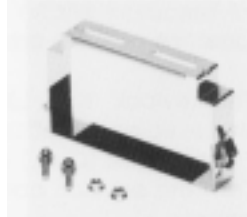

* LA320 longwave - shortwave active desktop loop aerial.

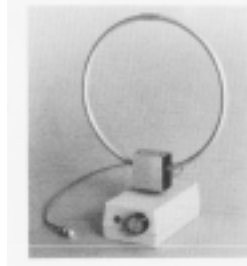

- * DA1000 parabolic aerial.
- * LA3000 low noise amplifier.
- * WX-2000 radio facsimile decoder with built-in printer.
- * CR400 tape recording lead.
- * ACEPAC-3A PC compatible computer control software.

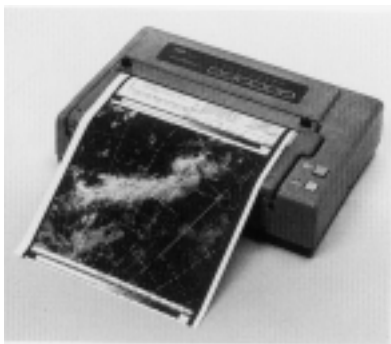



AOR, LTD.

2-6-4 Misuji, Taito-ku, Tokyo 111

Tel. 03-3865-1681