



308 Industrial Park Road
Starkville, MS 39759
(662) 323-9538 Fax: (662) 323-5803

Model 18AVQII
Five Band Vertical Antenna
10, 15, 20, 40, 80 Meter

INSTRUCTION MANUAL

General Description

The Hy-Gain 18AVQII is an omni-directional, vertical radiator that operates on the 10, 15, 20, 40, and 80 meter amateur bands. The system will work against earth ground or a resonant radial system when mounted above ground. You can make your own radial system following the manual, or use the Hy-Gain RRK-88 Radial System Kit available at your Hy-Gain dealer.

The antenna can be used for either Phone or CW with either a ground or roof mount. It can also be tuned to mid-band for use with either Phone or CW. In either case, the SWR bandwidths of the antenna are broad enough that the antenna will operate at an SWR of 2:1 or less on the 10, 15, 20 40 and 80-meter bands. The 18AVQII is supplied with stainless steel hardware and element clamps for all electrical and most mechanical connections.

Theory of Operation

The use of heavy duty "Hy-Q Traps" provides automatic band selection. The Hy-Q Traps are parallel resonant circuits that isolate the various sections of the antenna and give quarter wavelength resonance on all bands. The top-loading coil is used for operation on the 80-meter band while the overall height of the antenna remains less than 20 feet.

WARNING: When installing your antenna, take extreme care to avoid any accidental contact with power lines or overhead obstructions. Failure to exercise this care could result in serious or fatal injury.

Lightning Protection

For maximum lightening protection we recommend the use of a lightening arrestor installed on the feed-line along with a properly installed ground rod.

NOTE: If the terminals of the input connector are checked with an ohmmeter, they will show a direct short. This is normal! The matching coil in the antenna base puts the entire system at DC ground. However, it presents a 50-ohm load impedance to RF energy.

Choosing a Site

The 18AVQII can be mounted on the ground, on a rooftop, or on a mast. *The antenna must be secured using non-conducting guy ropes. When choosing an installation site be sure to allow sufficient space for these guy ropes.*

Radial System and Grounding

For best performance, the 18AVQII should be ground-mounted, clear of buildings and other structures. When the antenna is ground-mounted, a radial system is sometimes not needed. In most areas, where soil surface conductivity is poor and a good ground plane is not possible, lay out ground radials to improve the efficiency of your antenna.

When mounting the antenna more than three feet above ground, a resonant radial system must be used, such as Hy-Gain's RRK-88 Radial System Kit. If the antenna is roof mounted and the roof space is too small for a radial system, you can droop the radials over the edge of the roof at almost any angle without seriously changing the performance of the antenna. The radial system must be insulated from the roof and connected to a good ground for lightning protection.

Important: This antenna must be guyed for support. Non-conducting U-V proof guy rope (not included) should be secured between the tubing clamps (item #17) located below the 80-meter loading coil shown in Figure 2. The ends of the guys should be sufficiently anchored to the ground with stakes or another sturdy support.

Installation of Radials

There is no need to make radials exactly $\frac{1}{4}$ wavelength long for the 18AVQII. In fact, the only case where you should have $\frac{1}{4}$ wavelength radials would be for approximately 90 radials. This differs rather dramatically from the case of the elevated antenna where resonant radials are installed above ground. Since the radials of a ground-mounted vertical are actually on, if not in, the ground, they are coupled by capacitance or conduction to the ground, thus resonance effects are not important.

Basically, the function of radials is to provide a low-loss return path for ground currents. The reason that short radials are sufficient when few are used, is that at the perimeter of the circle to which the ground system extends, the radials are sufficiently spread apart. Most of the return currents are already in the ground between the radials rather than in the radials themselves. As more radials are added, the

spaces between them are reduced and longer lengths help to provide a path for currents still farther out. Since the 18AVQII is a multi-band, vertical antenna, the radial system should be optimized for the lowest frequency you plan to use. Higher frequencies will benefit equally from the ground system, while lower frequencies will not show as much improvement.

To determine the optimum radial installation for your 18AVQII, you must first decide what the limiting factor for your installation will be. The list below includes factors that need to be considered.

1. Cost of radial wires
2. Area available for radials
3. Efficiency of your antenna

Use figure 1 below to design a radial system to the optimum length for your preferred operating band.

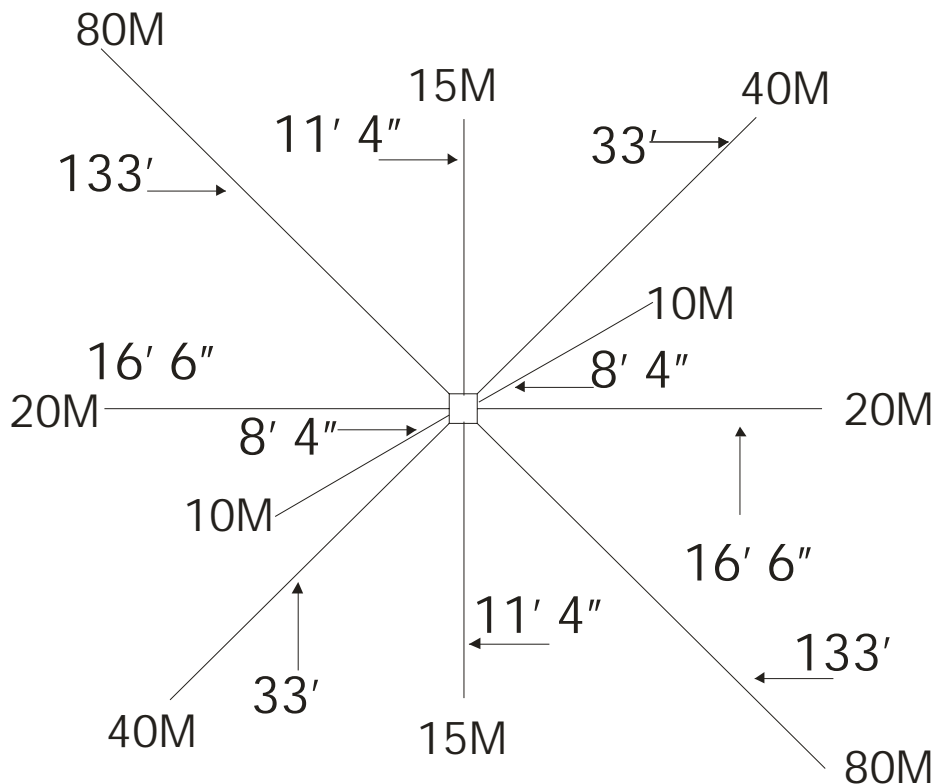

Figure 1
Optimum Radial Lengths, Dimensions from Base to Insulator

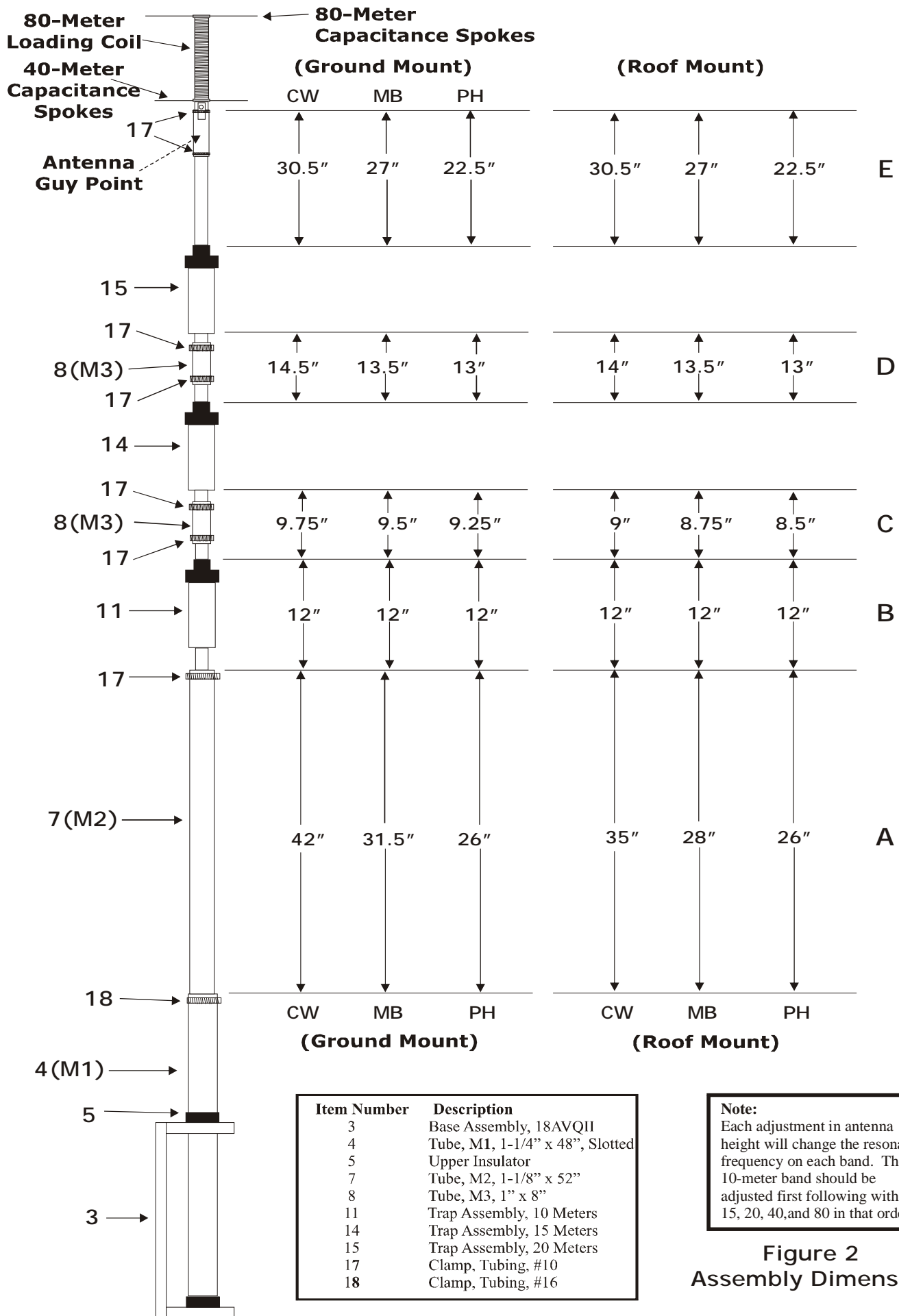

Figure 2
Assembly Dimensions

Assembly and Installation

Before you begin, read the instructions and study the illustrations. Compare the parts against the Parts List at the end of this manual. Decide where to mount your antenna (rooftop or ground) and what mode of transmission you will use (Phone, CW or Mid-Band). Take special notice of the dimensions in Figure 2. Dimensions will vary from one installation location to another due to ground conditions and other factors. The dimensions in Figure 2 are approximate and should be used as a reference for initial setup.

CAUTION: All of the antenna dimensions must be set on the mode chosen - all CW, all mid-band or all phone. Mixing dimensions in an attempt to improve another mode on certain bands will affect the resonance of all traps physically higher. Refer to Figure 2.

Tubing

Select the proper size tubing clamps as shown in figure 2. When installing the clamps, place the clamp near the tube end with the top of the clamp over the slot in the tube as shown in Figure 3. After adjustment of the tubing lengths, tighten the clamp with a 5/16-inch nut driver, socket, or open-end wrench until the tubing will not twist or telescope. DO NOT over-tighten!

M1 and M2 Section

Put a #16 tubing clamp (Item No. 18), un-tightened, over the M1 section (Item No. 4) (the base is attached to it already). Slip the 1 1/8" x 52" M2 section (Item No. 7) into the top of the M1 and set the M2 at dimension 'A', as shown in Figure 2. Dimension 'A' should be determined by the operating position and frequency. Slide the clamp into place around the top of the M1 and tighten it just enough to keep the M2 from slipping. It will be fully tightened later.

10-Meter Trap

Put an un-tightened #10 Tubing clamp (Item No. 17) over the M2 section, then slip the 10-meter trap (Item No. 11), bottom first, into the M2 section. (There is a plastic cover on the top of all three traps.) Set the trap at dimension "B", as shown in Figure 2. Slip the clamp into place around the top of

the M2 section and tighten it just enough to keep the trap from slipping. It will be fully tightened later.

15-Meter Trap and M3 Section Assembly

Place two, un-tightened #10 tubing clamps (Item No. 17) over one of the 1" x 8" long M3 section (Item No. 8). Slide the M3 section part way over the upper end of the 10-meter trap, then slide the lower end of the 15-meter trap (Item No. 14) into the M3 section. Set dimension "C", as shown in Figure 2, and locate the M3 so that it is equally spaced between the two traps. Tighten the clamps around the ends of the M3 just enough to keep parts from slipping. They will be fully tightened later.

20-Meter Trap and M4 Section Assembly

Assemble this section using the remaining M3 (Item No. 8) as was done on the 15 Meter trap and M3 Section Assembly. Use two more #10 tubing clamps (Item No.17) to attach the 20-meter trap (Item No.15) above the 15-meter trap. Refer to Figure 2 for choosing dimension "D".

80-Meter Loading Coil Assembly

1. Remove the loading coil parts from the packaging. Check to see that each is present using the packing list at the end of this instruction manual.
2. Place a 4-40 screw (Item No. 36) in each of the 16 holes on the capacitance spoke rings mounted on the loading coil assembly (Item No. 34) and secure them using a 4-40-kep nut (Item No. 37). Refer to figure 4. Snug each one using a 1/4" nut driver. Be careful not to lose the screws and nuts.
3. Place the large end of the 1 1/8" X 17" (Item No. 32) aluminum tubing over the end of the loading coil assembly tube as shown in Figure 4. The end will fit onto the 20-Meter trap assembly (Item No. 15).
4. Place two un-tightened #10 tubing clamps (Item No. 17) over the 1 1/8" x 17" tubing section. Refer to figure 4 on the next page. Be sure to place the connection tab between the aluminum tubing and the clamp as shown in Figure 4. Snug each of the tubing clamps using a 5/16" nut driver or equivalent wrench.
5. Place four capacitance spokes (Item No. 35) into each of the spoke rings located on the loading coil assembly and secure them in place by tightening the 4-40 screws.

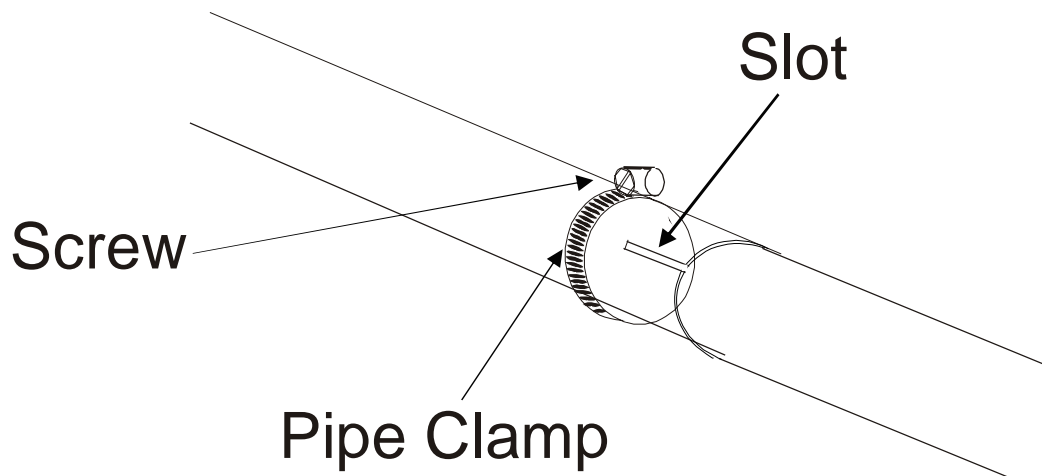

NOTE: Center the clamp over the slot. The clamp and slot may be oriented in any direction--not necessarily "up"

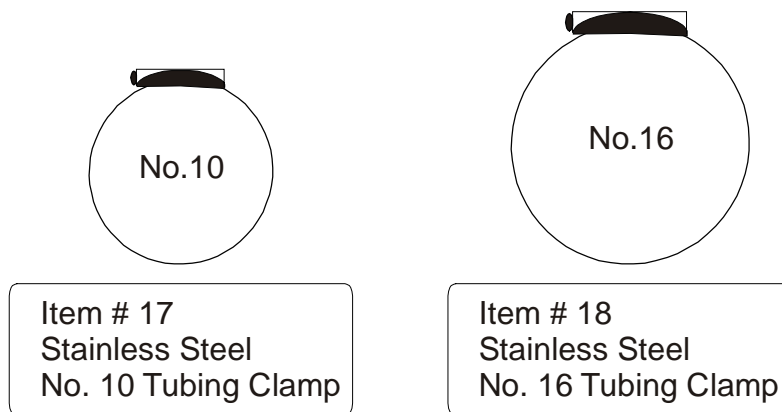

Figure 3

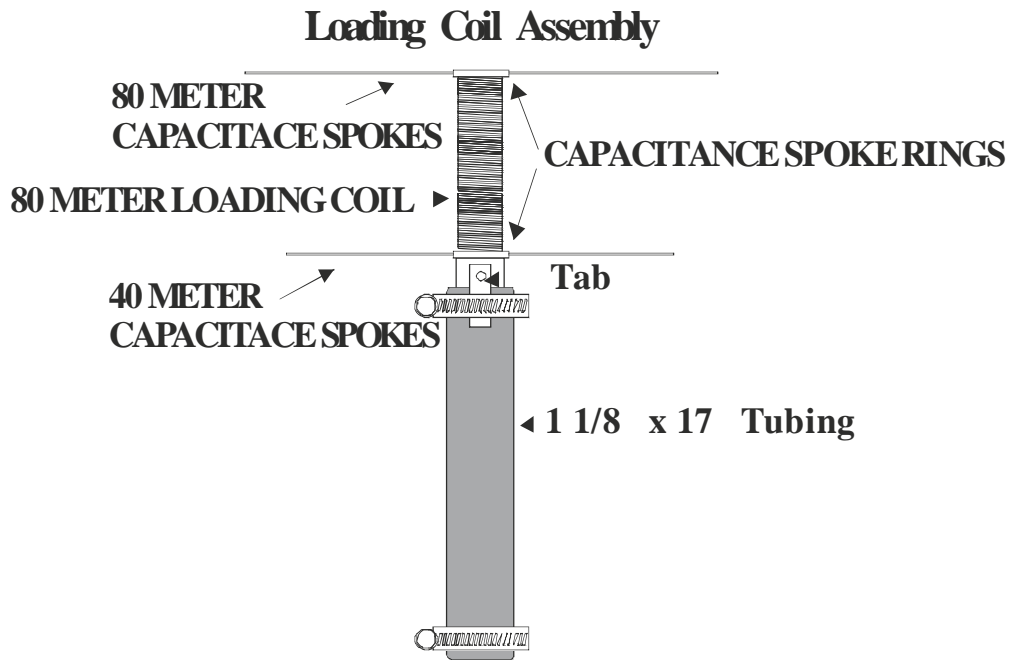
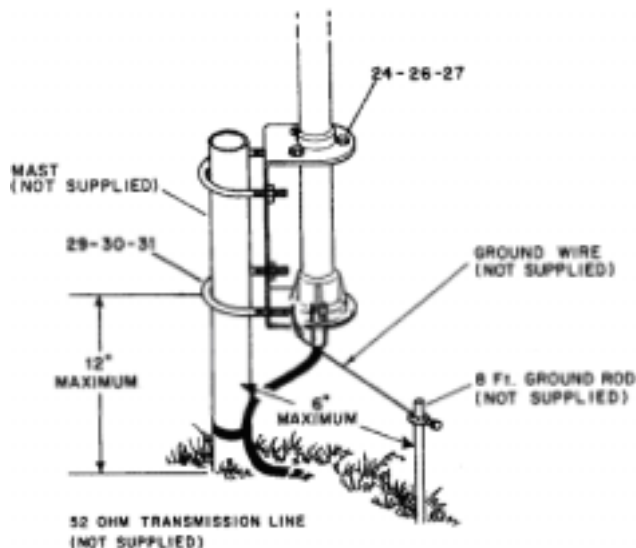

Figure 4
80 Meter Loading Coil

Installing the 80-Meter Coil

Place the 1 1/8" x 17 tubing section of the fully assembled 80-Meter loading coil onto the top of the 20-Meter trap assembly (Item No.15). Set the 80-Meter loading coil dimensions "E" using figure 2. Then secure it using the tubing clamp installed in the previous section. Tighten the clamp being careful not to over-tighten it.



Item No.	Description
24	Bolt, hex head, 1/4" - 20 x 3/4"
26	Lockwasher, internal, 1/4"
27	Nut, hex, 1/4"-20
29	U-Bolt, 5/16" x 1 5/8" x 2 1/4"
30	Lockwasher, split, 5/16"
31	Nut, hex, 5/16"-18

Figure 5 Antenna Installation

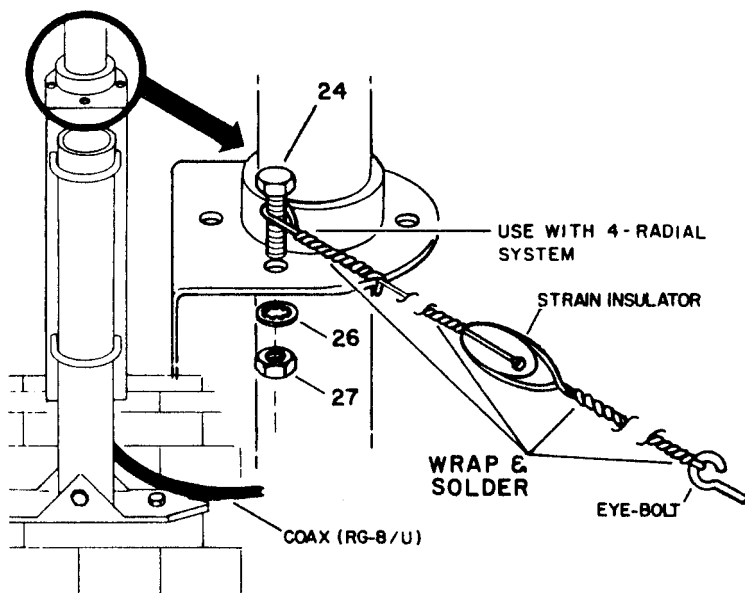

Figure 6 AV-14RMQ Roof Mounting Kit

Installing the Antenna

Refer to the mounting details in Figure 5 and 6 to install the completely assembled antenna.

First mount the completed antenna on your mast (not supplied) as shown in Figure 5. Use the two U-bolts, 5/16" nuts and 5/16" lock washers (Items

Nos. 29, 30 and 31). Use three (3) 1/4"-20 x 3/4" bolts, nuts and lock washers (Item No's 24, 26 & 27) to attach the insulator to the upper end of the mounting bracket. Tighten these items with a 7/16 wrench or equivalent.

NOTE: *If your antenna is mounted more than three feet above ground, a radial system must be added for proper operation.*

If you are roof mounting your antenna, as in Figure 6, use four (4) sets of 1/4"-20 hardware for the preceding step. Before tightening them, attach two adjacent radials to each set of hardware as shown in Figures 6. If desired, you may use the four, 33-foot radial system shown.

This system must be grounded for lightning protection. Connect a ground wire to one U-bolt on the antenna base and run it to a buried, 8-foot (250 cm) ground rod by the shortest route. If you are ground mounting your antenna, install it as shown in Figure 4. You must install an 8-foot ground rod as shown in Figure 5.

CAUTION: Keep the radials out of the reach of adults, children or pets. They are HOT with RF proportional to the power of the antenna.

Hooking Up the Antenna

Connect your coax (RG-213/U or RG-8) to the SO-239 connector at the bottom of the mounting bracket. (Coax not supplied.) Weather seal the coax connection with Coax-Seal© or an equivalent to prevent moisture from shorting out the connection.

Final Adjustment (Optional Fine Tuning Of Your Installation) A transmitter and SWR meter or bridge may be used for final tuning. However an SWR Analyzer will make tuning much easier.

1. The antenna operates progressively from 10 thru 40 meters. Even though you may not be using 10 meters at the present time, 10 meters must be adjusted, because any adjustment made between the distance to the base and the first trap automatically changes all of the bands above it.
2. Because every antenna installation is influenced by the soil conditions and the proximity effect of nearby objects, the dimensions in the manual must be fine tuned to put the antenna VSWR exactly where you want it on each band.
3. Beginning on 10 meters, make a VSWR curve checking the low end, center and high end of the band. This will indicate if the antenna favors the low end or the high end as installed.

- 3a. If it favors the low end, shorten the 10-meter adjustment one inch or no more than 1 1/2 inches. Run another VSWR measurement. Now you will have an indication of how far that distance moved the antenna in your location. Make what additional adjustments are indicated by the VSWR curve to put 10 meters exactly on the portion of the band you desire as your center operating frequency.
- 3b. If the antenna favors the high end, lengthen the dimension correspondingly to move the antenna to a lower frequency as outlined above.
4. Next, repeat this same procedure for 15 meters to put that band on frequency.
5. The same procedure is then used to set up the 20-meter band.
6. The resonant frequency of the 40-meter band is adjusted by increasing or decreasing dimension "E" of Figure 2. Once the resonant frequency is found on the 40-meter band, the SWR can be minimized by adjusting the capacitance spokes in step 7.
7. The SWR of the 40 and 80 Meter bands can be lowered by trimming small lengths of the capacitance spokes. Never remove more than 1 inch of the spokes without checking the SWR and resonant frequency. This process may need to be repeated several times to obtain the desired resonant frequency and SWR. Be sure to check and record the resonant frequency and SWR of both the 40 and 80 meter while making adjustments. Trim lengths from the 40-meter spokes first then move on to the 80-meter spokes.
Finally secure the capacitance spokes by tightening the 4-40 kep nuts with a 1/4" nut driver.
8. Most verticals are monopole antennas or half of a dipole. For this reason, the soil conditions, when the antenna is ground mounted, are important as it makes up the other half of the antenna. When you roof mount the antenna, radials must be used as outlined in the assembly instructions, to provide the other half of the antenna.
9. Tighten all mechanical connections when adjustments are complete.

PARTS LIST

Item No.	Part No.	Description	Qty.
3	871049	Base Assembly	1
4	190900	Tube, M1, 1 1/4 x 48", slotted	1
7	190303	Tube, M2, 1 1/8 x 52"	1
8	190603	Tube, M3, 1" x 8"	2
32	190315	Tube 1 1/8" x 17" SW	1
11	877132	Trap, 10 Meter Assembly	1
14	877131	Trap, 15 Meter Assembly	1
15	877129	Trap, 20 Meter Assembly	1
34	11-18avqii-1	Loading Coil Assembly	1
35	810-0640-27	36" spokes	10
38	925-18AVQII	Manual (18-AVQII)	1
33	872014	Parts Pack(Includes parts below)	1
17	745-3110S	Clamp, Tubing No. 10, SS	8
18	745-3116S	Clamp, Tubing No. 16, SS	1
24	505266	Bolt, hex head, 1/4 "-20 x 3/4"	4
26	562961	Lockwasher, internal, 1/4", SS	4
27	554099	Nut, Hex, 1/4-20, SS	4
29	543792	U-Bolt, 5/16" x 15/8"x 2 1/4"	2
30	564792	Lockwasher, split 5/16"	4
31	555747	Nut, hex, 5/16"-18, SS	4
36	656-0375S	Screw, PHMS, 6-32" x 3/8", SS	18
37	705-06325-K	Hex Nut, Kep, 6-32" SS	18

Notes:

DISCLAIMER

Information in this manual is designed for **user purposes only** and is *not* intended to supersede information contained in customer regulations, technical manuals/documents, positional handbooks, or other official publications. The copy of this manual provided to the customer will *not* be updated to reflect current data.

Customers using this manual should report errors or omissions, recommendations for improvements, or other comments to Hy-Gain Inc, 308 Industrial Park Road, Starkville, MS 39759. Phone: (662) 323-9538; FAX: (662) 323-6551. Business hours: M-F 8-4:30 CST.

hy-gain® LIMITED WARRANTY

hy-gain Warrants to the original owner of this product, if manufactured by *hy-gain* and purchased from an authorized dealer or directly from *hy-gain* to be free from defects in material and workmanship for a period of **12** months for rotator products and **24** months for antenna products from date of purchase provided the following terms of this warranty are satisfied.

The purchaser must retain the dated proof-of-purchase (bill of sale, cancelled check, credit card or money order receipt, etc.) describing the product to establish the validity of the warranty claim and submit the original or machine reproduction of such proof-of-purchase to *hy-gain* at the time of warranty service. *hy-gain* shall have the discretion to deny warranty without dated proof-of-purchase. Any evidence of alteration, erasure, or forgery shall be cause to void any and all warranty terms immediately.

1. *hy-gain* agrees to repair or replace at *hy-gain's* option without charge to the original owner any defective product under warranty, provided the product is returned postage prepaid to *hy-gain*.
2. Under no circumstances is *hy-gain* liable for consequential damages to person or property by the use of any *hy-gain* products.
3. Out-of-warranty Service: *hy-gain* will repair any out-of-warranty product provided the unit is shipped prepaid. All repaired units will be shipped COD to the owner. Repair charges will be added to the COD fee unless other arrangements are made.
4. This warranty is given in lieu of any other warranty expressed or implied.
5. *hy-gain* reserves the right to make changes or improvements in design or manufacture without incurring any obligation to install such changes upon any of the products previously manufactured.
6. All *hy-gain* products to be serviced in-warranty or out-of-warranty should be addressed to *hy-gain*, **308 Industrial Park Road, Starkville, Mississippi 39759, USA** and must be accompanied by a letter describing the problem in detail along with a copy of your dated proof-of-purchase.
7. This warranty give you specific rights, and you may also have other rights that will vary from state to state.