



RCI-2950^{DX}

RCI-2970^{DX}-150

**AM/FM/SSB/CW Dual Band
Amateur Mobile Transceiver**



Service Manual

CHAPTER 1		PAGE
SPECIFICATIONS		
1.0	General	2
1.1	Transmitter	2
1.2	Receiver	2
 CHAPTER 2		
INTRODUCTION		
2.0	Introduction	3
2.1	Features	3
 CHAPTER 3		
OPERATION		
3.0	Introduction	4
3.1	Control & Connections	4
3.2	Microphone	8
3.3	Operation	8
 CHAPTER 4		
PROGRAMMING		
4.0	Introduction	11
4.1	Frequency Selection	11
4.2	Frequency Scanning	11
4.3	Offset Frequency Operation	13
 CHAPTER 5		
CIRCUIT DESCRIPTION		
5.0	Introduction	14
5.1	PLL Circuit	14
5.2	Receiver Circuit	14
5.3	Transmitter Modulation Circuit	14
5.4	Transmitter Amplifier Circuit	14
 CHAPTER 6		
ALIGNMENT		
6.0	Required Test Equipment	18
6.1	Alignment Procedures	18
 CHAPTER 7		
MAINTENANCE		
7.0	Precautions	22
7.1	Periodic Inspection	22
7.2	Fuse Replacement	22
 CHAPTER 8		
DIAGRAMS AND PART LIST		
8.0	PCB Layout & Part List	23

1.0 GENERAL

Model	RCI-2950 DX / RCI-2970 DX
Frequency Range	12 meter : 24.8900 ~ 24.9900 MHz 10 meter : 28.0000 ~ 29.6900 MHz
Tuning Steps	100 Hz, 1 KHz, 10 KHz, 100 KHz, 1 MHz
Emission Modes	AM(A3)/FM(F3)/LSB,USB(A3J)/CW(A1)
Frequency Control	Phase-Lock-Loop (PLL) synthesizer
Frequency Tolerance	± 0.005 %
Frequency Stability	± 0.001 %
Operating Temperature Range	0°C to +40°C
Microphone	400 ohm, Dynamic PTT
Meter Function	RF Output, RX Receive Signal Strength, SWR Calibration and SWR
Input Voltage	13.8V DC
Antenna Connector	UHF SO239
Dimensions For : RCI-2950 DX	7-3/4"(W) x 10-3/4"(L) x 2-3/8"(H)
RCI-2970 DX	7-3/4"(W) x 10-3/4"(L) x 3-7/8"(H)
Weight For : RCI-2950 DX	4 lb. 3 oz.
RCI-2970 DX	7 lb. 6 oz.

1.1 TRANSMITTER

RF Power Output (RCI-2950DX)	AM/FM/CW : 10 W ; SSB : 25 W PEP
RF Power Output (RCI-2970DX)	AM/FM/CW : 50 W ; SSB : 150 W PEP
RF Transmit Modes	AM/FM/SSB/CW
Modulation	A3E/16F3/J3E/A1A
Spurious Emissions	-50 dB
Carrier Suppression	-50 dB
Antenna Impedance	50 Ohms

1.2 RECEIVER

Sensitivity For 10dB S/N (AM; CW/SSB)	< 0.5µV; < 0.15µ V
Sensitivity for 12dB S/N (FM)	< 0.25µV
Image Rejection Ratio	-65 dB
Automatic Gain Control (AGC) Figure Of Merit	SSB/CW/AM : 80 dB for 50 mV for 10 dB Change in Audio Output
Audio Output Power	2.5 W @ 10% THD
Built-in Speaker	8 Ohms, 5 Watts.
External Speaker (Not Supplied)	8 Ohms; 5 Watts.

(SPECIFICATIONS SUBJECT TO CHANGE WITHOUT NOTICE)

2.0 INTRODUCTION

The Ranger RCI-2950 DX / RCI-2970 DX is a solid-state, fully synthesized Amateur 10 and 12 meter dual band mobile transceiver with full band coverage from 28.0000 MHz to 29.6999 MHz and 24.8900 MHz to 24.9900 MHz and all mode operation, including: AM, FM, USB, LSB, CW and PA modes. The 10 most commonly used frequencies can be pre-programmed by the user for easy channel access.

2.1 RCI-2950 DX / RCI-2970 DX FEATURES

- 25 Watts PEP of Output Power (RCI-2950 DX)
- 150 Watts PEP of Output Power (RCI-2970 DX)
- Full Band Coverage
- All Mode Operation
- Brightness Control
- CTCSS Encoder/Decoder (Optional)
- Repeater/Offset Switch
- Programmable Frequencies
- Built-in Dual VFO
- RIT (RX Incremental Tuning)
- Squelch
- Noise Blanker
- RF Gain Control
- RF Power Output Selector
- External Speaker Connection
- PA Mode
- LCD Display
- Multi-Function LCD Meter

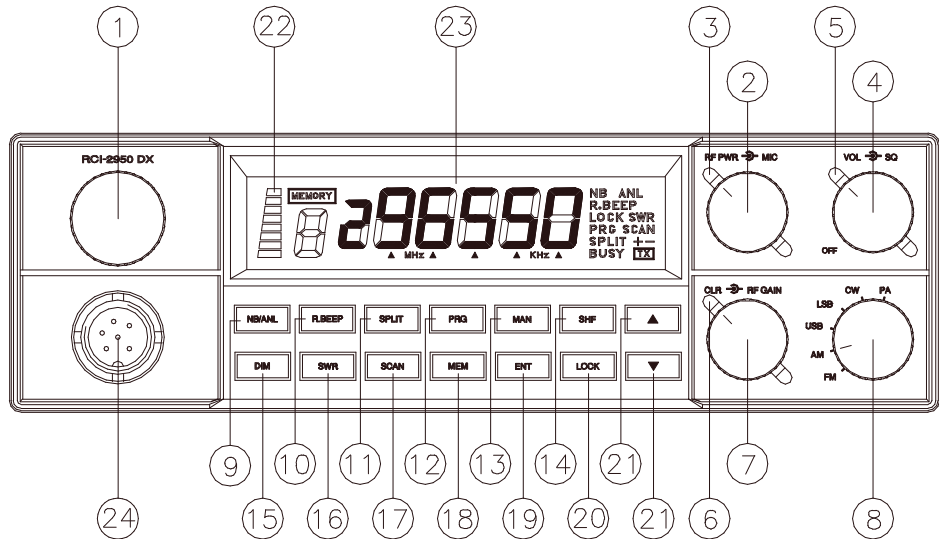

Figure 3-1 Front Panel

3.0 INTRODUCTION

This section explains the basic operating procedures for the RCI-2950 DX / RCI-2970 DX Amateur 10 and 12 meter dual band mobile transceiver.

3.1 CONTROL AND CONNECTIONS

3.1.1 FRONT PANEL

Refer to the above Figure 3-1 for the location of the following controls.

1. FREQUENCY SELECTOR

This control is used to select a desired transmit and receive frequency.

2. RF POWER CONTROL

This control allows the user to adjust RF power output.

3. MIC GAIN CONTROL

Adjusts the microphone gain in the transmit and PA modes. This controls the gain to the extent that full talk power is available several inches away from the microphone. In the Public Address (PA) mode, the control functions as the volume control.

4. ON/OFF VOLUME CONTROL

This knob controls the volume and the power to the radio. To turn the radio on, rotate knob clockwise. Turning the knob further will increase the volume of the receiver.

5. SQUELCH CONTROL

This switch is used to eliminate background noise being heard through the receiver which can be disturbing when no transmissions are being received. To use this feature, turn the switch fully counterclockwise and then turn clockwise slowly until the background noise is just eliminate. Further clockwise rotation will increase the threshold level, which a signal must overcome in order to be heard. Only strong signals will be heard at a maximum clockwise setting.

6. RF GAIN CONTROL

This control is used to reduce the gain of the RF amplifier under strong signal conditions.

7. CLARIFIER CONTROL

Allows tuning of the receive frequency above or below the assigned frequency by up to 500 Hz. Although this control is intended primarily to tune in SSB/CW signals, it may be used to optimize AM/FM signals.

8. MODE (FM/AM/USB/LSB/CW/PA) SWITCH

This switch allows you to select one of the following operating modes: FM/AM/USB/LSB/CW/PA.

9. NB/ANL BUTTON (NB/ANL)

In the NB/ANL position, the RF Noise Blanker and Automatic Noise Limiter in the audio circuits are also activated. The Noise Blanker is very effective in eliminating repetitive impulse noise such as ignition interference.

10. ROGER BEEP BUTTON (R.BEEP)

In the Roger Beep position, the radio transmits an audio tone at the end of your transmission to indicate that transmission has ended. As a courtesy to others, use the Roger Beep only when necessary.

11. SPLIT BUTTON (SPLIT)

This control activates the offset frequency function. It causes the transmit frequency to be offset either above or below the receive frequency by a user programmable amount to allow operation of an FM Repeater.

12. PROGRAM BUTTON (PRG)

This button is used to program operating or scanning frequencies into memory. See the OPERATION section of the manual for further details.

13. MANUAL BUTTON (MAN)

This is used to return the unit to manual mode.

14. SHIFT BUTTON (SHF)

This is used to select 100 Hz, 1 KHz, 10 KHz, 100 KHz or 1 MHz frequency steps.

15. DIM BUTTON (DIM)

This button adjusts the display backlighting in four different steps to best match the ambient light.

16. SWR BUTTON (SWR)

This control is used to check SWR.

17. SCAN BUTTON (SCAN)

This is used to scan frequencies in each band segment. The OPERATION segment of this manual provides detailed information on using the SCAN control.

18. MEMORY BUTTON (MEM)

This button is used to program memory channels. Detailed information on how to use this control is provided in the OPERATION section of this manual.

19. ENTER BUTTON (ENT)

This is used to program frequencies in memory. See the OPERATION section of this manual for more information on using this control.

20. LOCK BUTTON (LOCK)

This button is used to lock a selected frequency. Press it to activate the switch. In this position, it disables the Frequency Selector Control, up/down buttons on the front control panel and remote up/down buttons on the microphone. Reprising the switch will unlock the frequency.

21. UP/DOWN SELECTOR (st)

These buttons are used in conjunction with the shift key to move the frequency upward or downward to select a desired frequency.

22. METER

This meter indicates received signal strength, transmitter RF output power and SWR level.

23. LCD DISPLAY

The LCD displays the frequency selected, functions and memory channel.

24. MIC JACK

Accepts 6 pin female connector with a type Philmore T616C or Calrad 30445 style connector.

3.1.2 REAR PANEL

Figure 3-2 represents the location of the following connections:

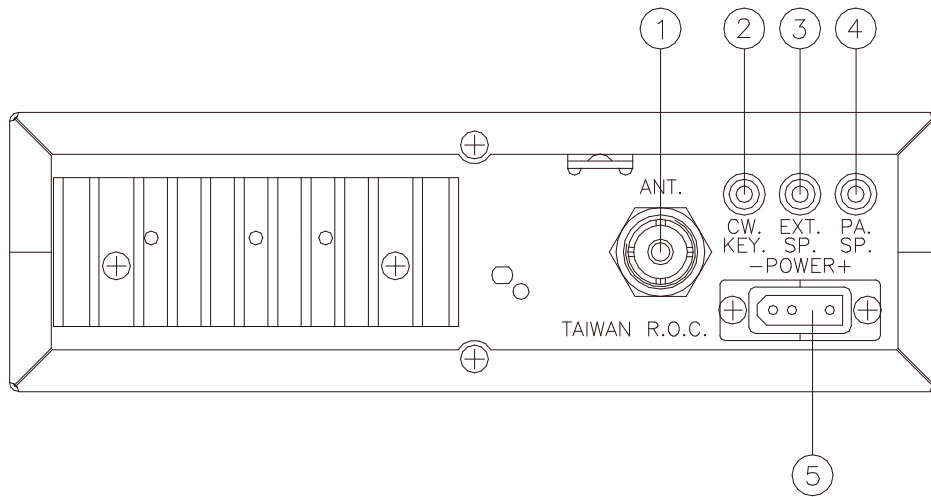

Figure 3-2 Rear Panel

1. ANTENNA

This jack accepts 50 ohms coaxial cable with a PL-259 type plug.

2. CW KEY

This jack is for Morse code operation. To operate, connect a CW key to this jack and place the MODE switch in the CW position.

3. EXT. SP.

This jack accepts 4 to 8 ohms, 5 watts external speaker. When the external speaker is connected to this jack, the built-in speaker will be disabled.

4. PA. SP.

This jack is for PA operation. Before operating, you must first connect a PA speaker (8 ohms, 5 W) to this jack.

5. POWER

This connector accepts 13.8V DC power cable with built-in fuse. The power cord provided with the radio has a black and red wire. The black goes to negative and the red goes to positive.

3.2 MICROPHONE

1. PTT SWITCH

The receiver and transmitter are controlled by the push-to-talk switch on the microphone. Press the switch and the transmitter is activated, release switch to receive. When transmitting, hold the microphone two inches from the mouth and speak clearly in a normal voice.

2. REMOTE UP/DOWN SWITCH

An operating frequency can be incremented or decremented simply by pushing either of these buttons.

3.3 OPERATION

3.3.1 CHANNEL SELECTION

Frequency selection for the RCI-2950 DX / RCI-2970 DX is simple. Select a desired operating frequency by rotating the Frequency Selector, or using the (σ) Up and (τ) Down buttons on the front panel or the microphone. Press the LOCK button to lock into the selected frequency. This will disable the Frequency Selector and the up/down buttons on the front panel and the microphone. Repeating the LOCK button unlocks the frequency. Use the SHF button to step frequency in either 100 Hz, 1 KHz, 10 KHz, 100 KHz or 1 MHz increment when you select a band segment. The frequency step is indicated by a small triangle directly under the corresponding digit on the frequency display.

3.3.2 MODE SELECTION

To select an operating mode on your RCI-2950 DX / RCI-2970 DX, simply rotate the MODE selector and place it in the desired operating mode position.

FM/AM/USB or LSB modes are for your voice communications. In the CW position, you can transmit CW if you have connected an external key to the accessory jack provided on the back of the radio. In the PA position, the transceiver can be used as a Public Address system. Before operating in PA mode, you must first connect a PA speaker (8 ohms, 5 Watts) to the jack located on the rear panel.

3.3.3 RF POWER CONTROL

This feature allows the adjustment of the RF output power continuously for the RCI-2950 DX (AM 1W to 10W; SSB: 10W to 25W), and (AM: 8W to 50W; SSB: 18W to 100W) for the RCI-2970 DX.

3.3.4 RECEIVE SCANNING

Receive scanning allows you to find active frequencies in the entire band segment. To begin scanning, slowly turn the Squelch control clockwise until the receiver noise disappears. Press the Scan button. The unit should start scanning from the lower to the higher frequencies. Pressing the Scan button again will change the direction of scanning. Each time you press the Scan button, "SCAN+" or "SCAN-" will be displayed on the LCD display. The radio will stop on any active frequency for the entire duration of the transmission. When the transmission stops, the RCI-2950 DX / RCI-2970 DX will wait approximately 2 seconds before it resumes scanning. If you want to deactivate Scan mode while it is scanning, press the MAN (manual) button or turn the Squelch control counterclockwise until you hear the receiver noise. The Manual button will disable Scan function.

3.3.5 SPLIT FUNCTION

This function enables you to offset the transmit and receive frequencies for FM repeater operation. The transmitter frequency can offset either higher or lower than the receive frequency. To split frequencies, press the **MAN** button and the Split button to select either +/- split frequency. If the + split is selected, the transmit frequency will be higher than the receive frequency. If - split is selected, the transmit frequency will be lower than the receive frequency.

3.3.6 MEMORY FUNCTION

The RCI-2950 DX / RCI-2970 DX can store up to 10 most frequently used frequencies (from 0 to 9). To program a frequency into memory, follow the procedure described below:

- (1) Press the **MAN** button.
- (2) Press the **PRG** button.
- (3) Press the **MEM** button (“MEMORY” and “0” should appear on the left-hand side of the **LCD** display). Pressing the **MEM** button will advance the channel number from “0” to “9”.
- (4) Select the desired frequency you wish to store in memory.
- (5) Press the **ENT** button.
- (6) Repeat the same procedure to program other memory channels.

3.3.7 MEMORY CHANNEL SCANNING

You can scan and select any of these 10 preset frequencies by following the procedure described below:

- (1) Press the **MAN** button.
- (2) Press the **MEM** button.
- (3) Slowly turn the Squelch knob clockwise until the receiver noise disappears.
- (4) Press the Scan button. The unit will scan from lower to higher frequencies. When you press the button again, it will scan from higher to lower frequencies.
- (5) To stop scanning a certain channel, press the **MAN** button, or turn the Squelch knob counterclockwise until you hear the receiver noise.

3.3.8 METER

The meter built into your RCI-2950 DX / RCI-2970 DX on the left hand side of the **LCD** display provides the following information:

1. S/RF METER

In transmit mode, it provides a visual indication of transmit output power and received signal strength on the receive mode.

2. SWR METER

In order to achieve maximum radiated power, it is important that your antenna be in good condition, properly adjusted and matched to your transceiver. The built-in SWR (Standing Wave Ratio) meter allows you to measure your antenna condition. To operate this function, connect your antenna to the transceiver antenna connector, set the mode switch to AM and adjust the MIC GAIN to minimum. Select a frequency near the middle of the band you plan to use most. Activate the SWR function and press the PTT button on the microphone. A bar on the meter is an indication of the antenna matching. If there is no bar, it indicates that your antenna system is perfectly matched. The fewer bars, the better matched. If several bars appear, your antenna needs adjusting.

3.3.9 CTCSS - OPTIONAL

The RCI-2950 DX / RCI-2970 DX can operate with CTCSS frequencies for accessing repeaters, with an optional CTCSS (Continuous Tone Coded Squelch System) encoding device installed.

3.3.10 PROCEDURE TO RECEIVE

- (1) Be sure that power source, microphone and antenna are connected to the proper connectors before going to the next step.
- (2) Turn unit on by running **VOL** knob clockwise on transceiver.
- (3) Set the **VOL** to a comfortable listening level.
- (4) Set the **MODE** switch to the desired mode.
- (5) Listen to the background noise from the speaker. Turn the **SQ** knob slowly clockwise until the noise just disappears. The **SQ** is now properly adjusted. The receiver will remain quiet until a signal is actually received. Do not advance the control too far or some of weaker signals will not be heard.
- (6) Set the **CHANNEL** selector switch to the desired channel.
- (7) Set the **RF GAIN** control fully clockwise for maximum receive gain.
- (8) Adjust the **CLARIFIER** control to clarify the SSB signals or to optimize AM/FM signals.

3.3.11 PROCEDURE TO TRANSMIT

- (1) Select the desired channel of transmission
- (2) Set the **MIC GAIN** control fully clockwise.
- (3) If the channel is clear, depress the push-to-talk switch on the microphone and speak in a normal voice.

4.0 INTRODUCTION

This section explains the basic programming procedures for the RCI-2950 DX / RCI-2970 DX Amateur 10 and 12 meter dual band mobile transceiver.

4.1 FREQUENCY SELECTION

Frequency selection in the RCI-2950 DX / RCI-2970 DX can be accomplished using anyone of the three following methods:

- (1) The first method of frequency selection is through the use of the **SHF** (Shift) key and the (σ) Up and (τ) Down arrows. To accomplish this, press the **SHF** button until the cursor arrow is positioned under the digit of the frequency that is to be changed, then use the (σ) Up arrow to increase the number. If a decrease in frequency is desired, press the (τ) Down arrow. Perform the steps described above for each digit of the frequency until the desired frequency is displayed in the LCD display window.
- (2) The second method of frequency selection is accomplished using the **SHF** button and the frequency select knob located above the microphone jack. Use the **SHF** button in the manner described above to select the digit to be changed. Proceed to rotate the frequency select knob clockwise to increase the frequency. Rotate the frequency select knob counterclockwise to decrease the frequency.
- (3) The third method of selecting the operating frequency of the radio is through the use of the **SHF** button and the Channel (σ) Up and (τ) Down buttons located on the microphone. Frequency selection by this method is accomplished in the same manner as with the (σ) Up and (τ) Down arrows on the keypad. The only difference is that the Channel Up and Down buttons on the microphone are used.

4.2 FREQUENCY SCANNING

Frequency scanning can be achieved using one of two methods: the first method involves the scanning of pre-programmed memory channels. The second method permits the user to scan all frequencies between a pre-set upper and lower scan limit.

4.2.1 ALL FREQUENCY SCANNING

To allow all Frequency Scanning, one must first program the upper and lower scanning limits. The scan limits are simply the highest and lowest frequencies that will be scanned. To program these limits, perform the following steps:

- (1) Press the **PRG** (Program) key.
- (2) Press the **SCAN** key (“**PRG SCAN+**” should appear in the lower right corner of the display window).
- (3) Using the **SHF** key and the (σ) Up and (τ) Down arrows, select the upper scan limit, then press **ENT**.

(4) Press the **SCAN** key again (“**SCAN-**” should appear in the display window).

(5) Using the **SHF** key and (σ) Up and (τ) Down arrows, select the lower scan limit, then press **ENT**.

The upper and lower scan limits have now been programmed. To activate the scan feature, return the radio to manual operation and press the **SCAN** button. If the display shows “**SCAN+**”, the radio will scan from the lower limit to the upper limit. If “**SCAN-**” is displayed, the unit will scan from the upper limit to the lower limit. To change from **SCAN+** to **SCAN-** or vice versa, press **SCAN**.

NOTE

When programmed, the upper and lower scan limits will also act as the upper and lower operating limits of the radio. The radio now cannot be programmed to operate above or below the scan limits.

4.2.2 MEMORY SCANNING

The RCI-2950 DX / RCI-2970 DX has 10 non-volatile (i.e. memory resident) memory locations which can be programmed with any available frequency within the operating band of the radio. The scan function of the unit can be programmed to scan these memory channels. The radio will then scan only those memory channels which have been programmed. The first step in utilizing the memory scan function is to program the desired frequencies into the radio memory. This can be accomplished by performing the following steps:

(1) With the radio operating in the manual mode, press the **PRG** (Program) key.

(2) Press the **MEM** (Memory) key. “**PRG**” should be displayed in the lower right-hand corner of the LCD display window. In the upper left portion of the display, “**MEMORY**” should be displayed. Directly below **MEMORY**, a number between 0 and 9 will be displayed. This number represents the memory location currently being displayed. Pressing the **MEM** key will increase the memory counter to the next memory location and the contents of that memory location will be displayed.

(3) Using the **SHF** key and the (σ) Up and (τ) Down arrows, enter the frequency to be stored in the memory location displayed. After the desired frequency has been entered, press **ENT**.

(4) Repeat steps (2) and (3) for all the memory locations to be programmed.

(5) After all desired memory locations have been programmed with frequencies, return the unit to the manual mode of operation by pressing the **MAN** key.

(6) To initiate memory scanning, press **MEM** and then press **SCAN**. As previously discussed, the display will show “**SCAN+**” or “**SCAN-**” to indicate whether the radio is scanning from the lowest or the highest memory location or vice versa.

(7) To return the radio to normal (non-scanning) operation, press the **MAN** key.

4.3 OFFSET FREQUENCY OPERATION

The RCI-2950 DX / RCI-2970 DX has an offset or split frequency feature that will permit the radio to be operated in a half-duplex mode. This will allow the user to talk on FM repeaters operating in the 10 and 12 Meter bands.

NOTE

The FM repeaters may require a subaudible (CTCSS) tone be transmitted to gain access to the repeater. The RCI-2950/2970 DX is not factory equipped with a CTCSS encoder/decoder.

The split frequency function offsets the transmitter frequency either above or below the receive frequency by a user programmable amount. In the following example, programming of a 100 KHz offset will be described. Before attempting to program the offset frequency, ensure that the radio is operating in the manual mode by pressing the **MAN** key.

- (1) Press the **PRG** (Program) key.
- (2) Press the **SPLIT** key. The LCD display window will display “00000” with “PRG” and “SPLIT” being displayed in the lower left-hand corner.
- (3) Using the **SHF** key and the (σ) Up and (τ) Down arrows as described earlier, program the display to read “010000”.
- (4) Press **ENT**. A 100 KHz offset has now been programmed into the radio.
- (5) Return the radio to manual operation by pressing the **MAN** key.
- (6) Using the **SHF** key and the (σ) Up and (τ) Down arrows as described previously, set the radio for the desired receive frequency.
- (7) Press **SPLIT**. In the lower right corner of the display, either “SPLIT+” or “SPLIT-” will be displayed. If **SPLIT+** is displayed, the transmitter will be offset 100 KHz above the receive frequency when keyed. If **SPLIT-** is displayed, the transmitter will be offset 100 KHz below the receive frequency.

NOTE

When the transmitter is keyed, the frequency display will change to show the frequency being transmitted.

- (8) To return the radio to simplex operation (i.e., same transmit and receive frequency), press the **MAN** key.

5.0 INTRODUCTION

This section explains the technical theory of operation for the RCI-2950 DX / RCI-2970 DX mobile transceiver.

5.1 PLL CIRCUIT

The Phase Lock Loop (PLL) circuit is responsible for developing the receiver's first local oscillator signal and the transmitter's exciter signal. The PLL circuit consists primarily of IC2, IC3, Q29, Q32, Q33, Q34, Q36, Q37, Q38 and L16. The PLL circuit is programmed by the rotary channel switch GPS-0688. The switch allows IC (U601) on CPU P.C.B to communicate the correct binary data information to the programmable divider inside of IC2. IC2 then controls the VCO (Voltage Controlled Oscillator) to oscillate on the correct frequency. This signal is fed either into the receiver's first mixer (for receive operation) or the transmitter's mixer (for transmit operation).

5.2 RECEIVER CIRCUIT

The incoming receives signal come into the radio via the antenna and into the front-end pre-amp consisting of Q19. The RF signal is fed into the mixer circuit of the Q20 and Q21. The signal is then filtered by L8, L9 and L10 then into the AM/FM IF section of the receiver (depending on the mode of operation). The signal is then detected by either the AM detector FM detector and then fed to the audio amplifier section of the receiver and finally out to the speaker.

5.3 TRANSMITTER MODULATION CIRCUIT

- (1) The transmitter modulation circuit modulates the low-level RF signal from the PLL exciter circuit with the user's audio voice signal from the microphone. The audio from the microphone is then amplified and fed into the balanced modulator circuit.
- (2) If the transceiver is in the AM mode, the AF power amplifier modulates the last RF amplifier which produces a true amplitude modulated RF signal.
- (3) If the transceiver is in the FM mode, the audio signal is not mixed with 10.6975MHz oscillator but instead phase modulates the basic exciter signal from the PLL circuit in the TX mixer.
- (4) If the transceiver is in the SSB mode, the audio signal is mixed with 10.6975MHz oscillator in IC5.

5.4 TRANSMITTER AMPLIFIER CIRCUIT

The transmitter takes the basic exciter signal from the TX mixer and amplifies it through a series of amplifiers consisting of Q64, Q63, Q62, Q61, Q60 and the EPA010010A amplifier (only for RCI-2970 DX) where it is sent out to the antenna connector.

RCI-2950DX BLOCK DIAGRAM

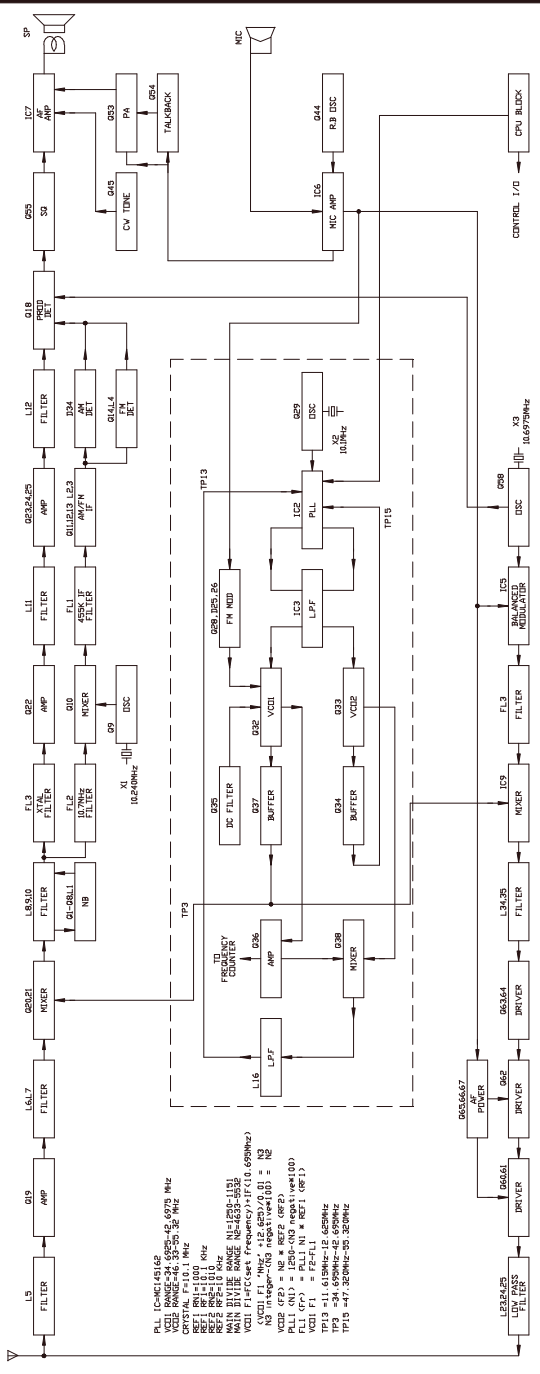

RCI-2970DX BLOCK DIAGRAM

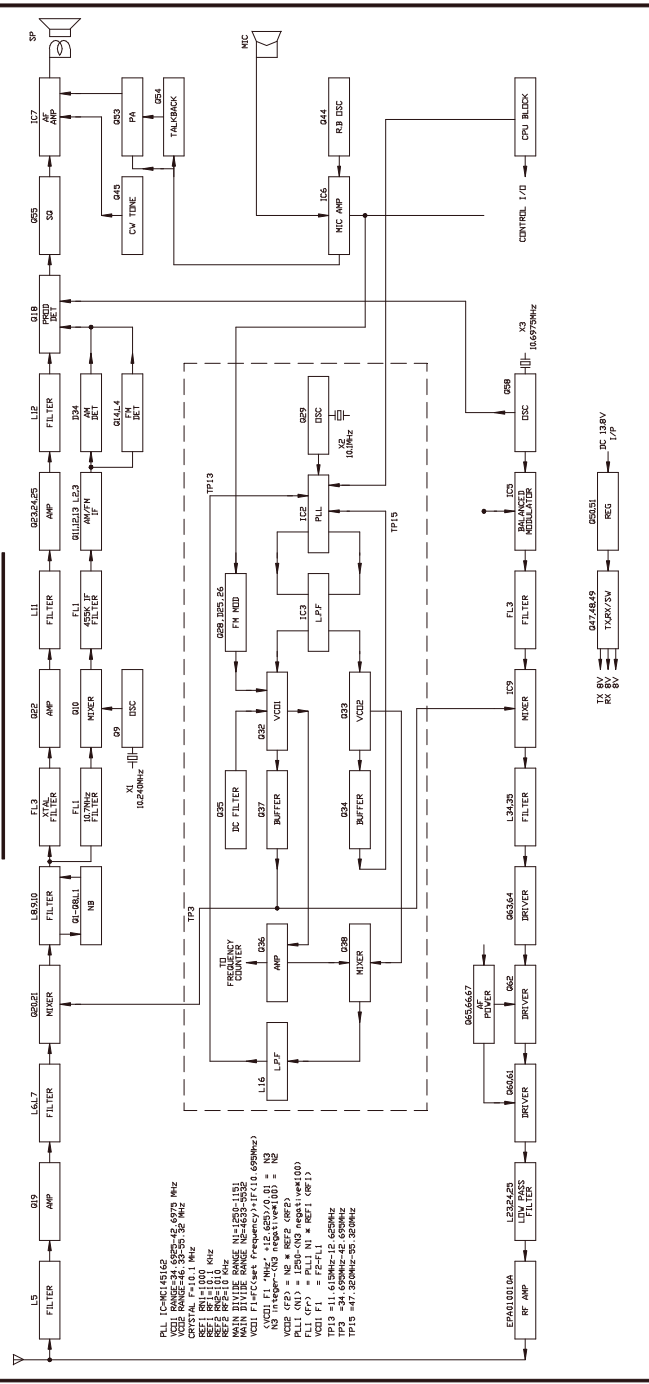

RCI-2950 DX / RCI-2970 DX CPU CIRCUIT DIAGRAM

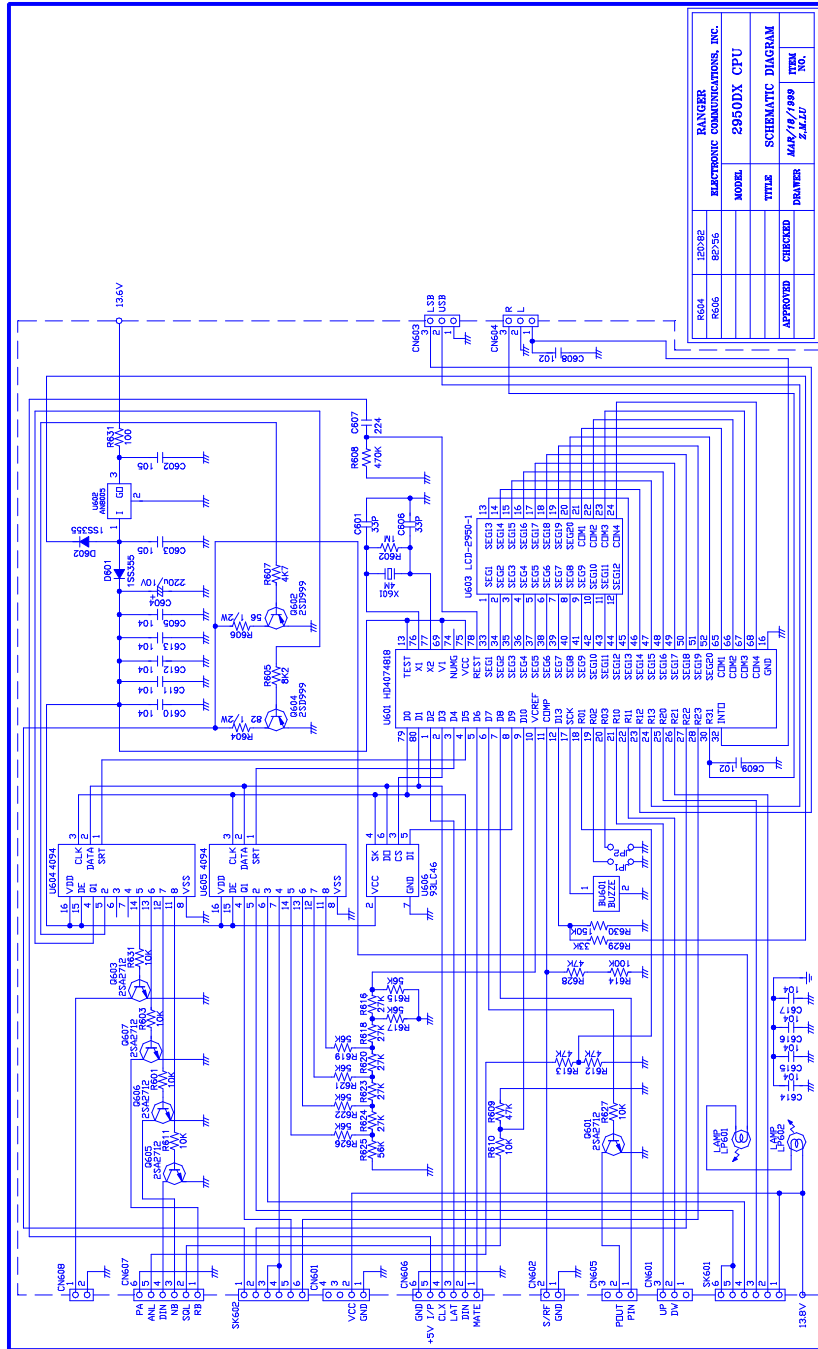

R604	1RD42	RANGER	ELECTRONIC COMMUNICATIONS, INC.		
R606	BP36	MODEL	2950DX CPU	APPROVED	TURN
		TITLE	SCHEMATIC DIAGRAM	CHECKED	NO.
		DRAWER	MAY/70/789		
			24240		

6.0 REQUIRED TEST EQUIPMENT

- | | |
|----------------------------------|---------------------------------|
| ① DC Power Supply (13.8VDC, 20A) | ⑥ Frequency Counter (100 MHz) |
| ② RF Wattmeter (100W) | ⑦ RF Signal Generator (100 MHz) |
| ③ Multimeter | ⑧ Automatic Distortion Meter |
| ④ Automatic Modulation Meter | ⑨ Oscilloscope (50 MHz) |
| ⑤ Audio Signal Generator | ⑩ Sinad Meter |

6.1 ALIGNMENT PROCEDURES

This transceiver has been aligned at the factory and does not require any adjustments at installation. The required test equipment listed are used for the test setup or alignment shown in Figure 6-1 Transmitter Test Setup and Figure 6-2 Receiver Test Setup. These test setups are used in part or total during the following adjustments and refer to Page 44 for adjustment location.

6.1.1 PLL ALIGNMENT

ITEM	U.U.T. SETTING	ADJUST POINT	MEASUREMENT
PLL 2 VCO Voltage	Set radio to 24.890 MHz, AM RX mode. Frequency setting at 29.699 MHz. Connect Multimeter to TP10.	L14	1.0 VDC \pm 0.1 \leq 4.5 VDC
PLL 1 VCO Voltage	Set radio to 24.890 MHz, AM RX mode. Frequency setting at 32.000 MHz. Connect Multimeter to TP11.	L13	1.0 VDC \pm 0.1 \leq 6.5 VDC
AM Frequency	Set radio to AM RX mode. Set Clarifier Control to 12 o'clock. Connect Frequency Counter to TP16.	VC2	10.1000 MHz \pm 10 Hz
TX Frequency	Set radio to AM TX mode. Connect Frequency Counter to TP16.	VR8	10.1000 MHz \pm 10 Hz
VCO Output	Set radio to 28.000 MHz, AM RX mode. Connect Oscilloscope to TP3.	L17	Maximum Output 38.6950 MHz @ TP3
AM OSC	Set radio to AM TX mode. Mod off. Connect Frequency Counter to TP5.	L18	10.6950 MHz \pm 10 Hz
USB OSC	Set radio to USB TX mode. Mod off. Short TP6 to ground. Connect Frequency Counter to TP5.	L20	10.6975 MHz \pm 10 Hz
LSB OSC	Set radio to LSB TX mode. Mod off. Connect Frequency Counter to TP5.	L19	10.6925 MHz \pm 10 Hz

6.1.2 TRANSMITTER ALIGNMENT

RCI-2970DX LEVELS ARE SHOWN IN [].

ITEM	U.U.T. SETTING	ADJUST POINT	MEASUREMENT
TX Power	Set radio to 28.000 MHz, AM TX mode. Modulation off. Set radio to 28.000 MHz, USB TX mode. AF signal 30mV, 1 KHz to microphone. Connect Oscilloscope to TP17. Set RF PWR Fully Clockwise. Set Clarifier Control to 12 o'clock. Set radio to 24.890 MHz & 29.699 MHz.	L18,L37,L35, L34 L35,L34	Maximum Output. Maximum Output and Balance.
AM APC	Set radio to AM TX mode. Connect Multimeter to TP8	VR15	6 VDC
SSB APC	Set radio to USB TX mode. Connect Multimeter to TP8	VR18	12.5 VDC
BIAS Current	Set radio to USB TX mode. Modulation off. Connect current meter to TP7(+) and TP9(-) Connect current meter to TP7(+) and TP8(-)	VR13 VR12 + VR11	10 mA (50 mA + 50 mA) = 100 mA
AM TX Power	Set radio to 28.000 MHz, AM TX mode. Modulation off. Connect "short PCB" to TP7 and TP9. Set RF PWR Fully Counter Clockwise. Connect RF Power Meter to antenna jack.	VR15 VR19	10W [50W] 1W [8W]
RF Power Meter	Set radio to 28.000 MHz, AM TX mode. Set RF Power Fully Clockwise.	VR10	Level Meter Indicator
SSB ALC	Set radio to USB TX mode. AF signal 30 mV, 1 KHz to microphone.	VR14	25W [150W, PEP]
SSB Carrier Balance	Set radio to USB TX mode. AF signal 30 mV, 1 KHz to microphone. Connect Oscilloscope to antenna jack.	VR7	Spurious Emission to minimum.
CW TX	Set radio to 28.000 MHz, CW TX mode. Plug in CW Key. Disconnect the Mic Jack. Connect AC Voltmeter to EXT SP.	VR9	200mV (Sine Wave)
AM Modulation FM Modulation	Set radio to 28.000 MHz, AM TX mode. Set radio to 28.000 MHz, FM TX mode. AF signal 30 mV, 1 KHz to microphone. Set Mic Gain Fully Clockwise.	VR17	90% 4 KHz

6.1.3 RECEIVER ALIGNMENT

ITEM	SETTINGS	ADJUST POINT	MEASUREMENT
AM Sensitivity	Set radio to 28.000 MHz, AM RX mode. Set Clarifier Control to 12 o'clock. Set RF Gain Fully Clockwise. Set SQ Fully Counter Clockwise. Set NB/ANL/OFF switch to OFF position. Set VOL Control at 2 o'clock. Connect RF SG to antenna jack Frequency 28.000 MHz, 1uV. Mod 30%. Set radio to 24.890 MHz, AM RX mode. RF SG setting 24.890 MHz. Set radio to 29.699 MHz, AM RX mode. RF SG setting 29.699 MHz.	L5,6,7,8,9,10 ,2,3 L5,L6, L7	Audio Output > 2V S/N > 10 dB Balance between 24.890 and 29.699 MHz
USB Sensitivity	Set radio to USB RX mode. Set VOL Control Fully Clockwise. RF SG setting 28.001 MHz, 0.5uV. Mod off.	L11, L12	Audio Output > 2V S/N > 10 dB
LSB Sensitivity	Set radio to LSB RX mode. Set VOL Control Fully Clockwise. RF SG setting 27.999 MHz, 0.5uV. Mod off.	L11, L12	Audio Output > 2V S/N > 10 dB
FM Distortion	Set radio to 28.000 MHz, FM RX mode. Set MODE switch to FM mode. RF SG setting 28.000 MHz, 1mV. Mod 3KHz.	L4	Audio Output > 3V Distortion < 10%
NB Adjust	Set radio to 28.000 MHz, AM RX mode. RF SG setting 28.000 MHz, 100uV. Mod off. Set NB/ANL/OFF switch to NB/ANL position. Connect Voltmeter to TP1.	L1	DC Voltage to max. > 2V
AM Squelch	Set radio to 28.000 MHz, AM RX mode. Set SQ Control Fully Clockwise. RF SG setting 28.000 MHz, 1mV. Mod 30%.	VR4 Slowly	Adjust very slowly until squelch just open.
SSB Squelch	Set radio to USB RX mode. Set SQ Control Fully Clockwise. RF SG setting 28.001 MHz, 1mV. Mod off.	VR3 Slowly	Adjust very slowly until squelch just open.
AM S/R Meter AM S-Meter	Set radio to 28.000 MHz, AM RX mode. RF SG setting 28.000 MHz, 100uV. Mod 30%.	VR1	"6 bar" on the Level Meter Indicator.
SSB S-Meter	Set radio to USB RX mode. RF SG setting 28.001 MHz, 100uV. Mod off.	VR2	"6 bar" on the Level Meter Indicator.

Figure 6-1 Transmitter test setup

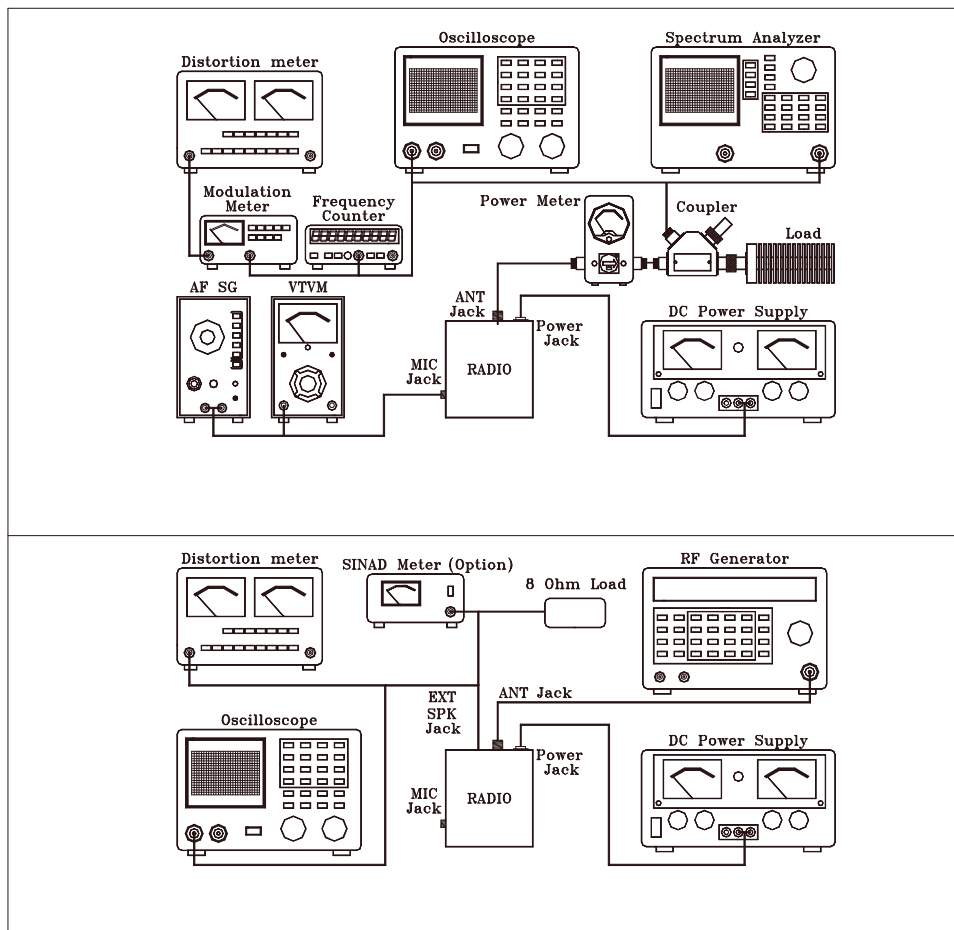

Figure 6-2 Receiver test setup

7.0 PRECAUTIONS

The inherent quality of the solid-state components used in this transceiver will provide many years of continuous use. Taking the following precautions will prevent damage to the transceiver.

- (1) Never key the transmitter unless an antenna or suitable dummy load is connected to the antenna receptacle.
- (2) Ensure that the input voltage does not exceed 16 VDC or fall below 11 VDC.
- (3) During alignment, do not transmit for more than 10 seconds at a time. Transmitting over long periods can cause heat built-up and cause transmitter damage.

7.1 PERIODIC INSPECTION

This unit is aligned at the factory to deliver maximum performance. However, continued performance cannot be expected without periodic inspection and maintenance. Important points to be checked regularly are as follows;

Check Item	Action
Whip antenna (option)	If cracked or broken, replace it.
Coaxial cable	If sheath is cracked, seal with vinyl tape. If immersed with water, install new coaxial cable.
Coaxial & power plug connections	If loosened, reconnect. If corroded, clean contacts.
Battery connection	If corroded, clean power terminals.
Ground terminal	If corroded, clean terminal.

7.2 FUSE REPLACEMENT

To protect the equipment from serious damage, a fuse is provided on the power supply lines. The fuse protect against overvoltage / reverse polarity or internal fault of the equipment. If the fuse has blown, first find out the cause of the trouble before replacing it. A fuse rated for more than 7A for RCI-2950 DX and 20A for RCI-2970 DX should not be used, since it may permanently damage the equipment. Damage due to overfusing is not covered by the warranty.

8.0 GENERAL

Information on most electrical and mechanical parts is included in the parts list. The reference designators are in alphanumeric order.

8.1 ORDERING REPLACEMENT PARTS

Parts orders should be referred to the parts department at:

- Ranger Communications, Inc.
401 W. 35TH ST.
NATIONAL CITY, CA 91950-7909

Tel: (619) 426-6440

Fax: (619) 426-3788

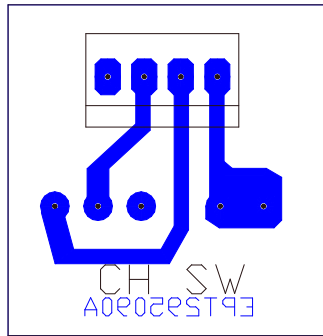

PART LIST:

RCI-2950 DX / RCI-2970 DX CH SW P.C.B

ITEM	REFERENCE NUMBER	RANGER PART NUMBER	DESCRIPTION
1		EPT295090A	CH SW P.C.B
2	PCB CONN/S 3PIN (COPPER SIDE)	CC0501037L	0.01μF 50WV
3	CH SW P.C.B	EWRT32051S	ROTARY SW
4	CH SW P.C.B	EX07N41216	PCB CONN/S 3PIN

REMARK:

COPPER SIDE (BLUE)

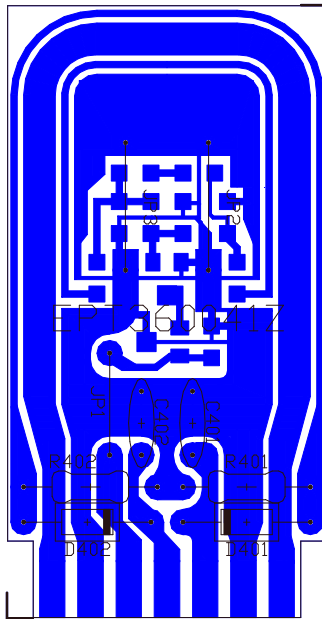

PART LIST:

RCI-2950 DX SWR P.C.B

ITEM	REFERENCE NUMBER	RANGER PART NUMBER	DESCRIPTION
1		EPT360041Z	SWR P.C.B
2	R402	RCP141014Z	100 OHM 1/4W
3	R401	RCP141214Z	120 OHM 1/4W
4	C401,C402	CC0501037L	0.01 μ F 50WV
5	D401,D402	ED1N00060P	DIODE 1N60P
6	JP2,JP3	WX01070710	JUMPER WIRE

REMARK:

COPPER SIDE (BLUE)

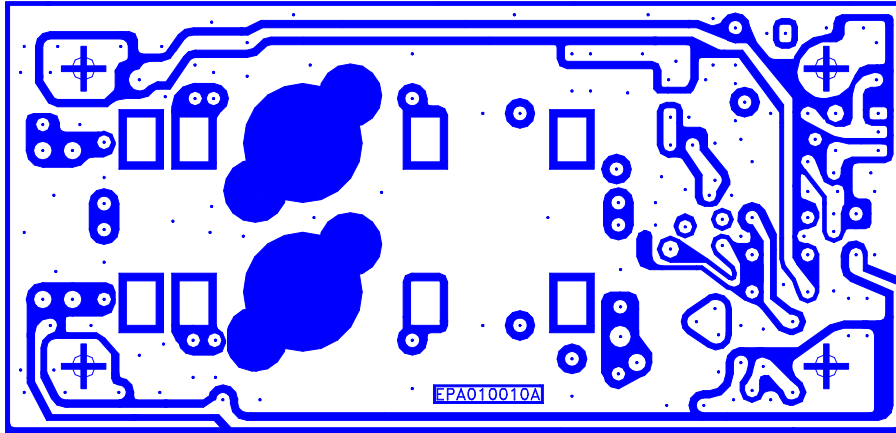
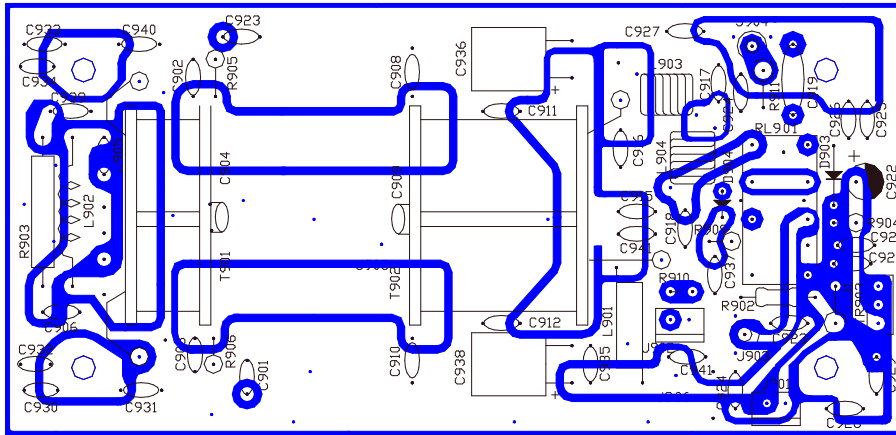

PART LIST:

RCI-2970 DX POWER P.C.B

ITEM	REFERENCE NUMBER	RANGER PART NUMBER	DESCRIPTION
1		EPA010010A	POWER P.C.B
2	R904	RCU141094Z	1 OHM 1/4W
3	R905,R906	RCU142204Z	22 OHM 1/4W
4	R902	RCM141024A	1K OHM 1/2 W
5	R911	RCP121034Z	10K OHM 1/2W
6	L902	RCP101004Z	10 OHM 1W
7	R903	RCP202204Z	22 OHM 2W
8	R910	RE10300069	10K OHM
9	BETWEEN C901 & G	RCP141024Z	1K OHM 1/4W
10	T	RFP202214Z	220 OHM 2W
11	COPPER	CC0502204L	22PF 50WV

ITEM	REFERENCE NUMBER	RANGER PART NUMBER	DESCRIPTION
12	C902,C903	CC0503915L	390PF 50WV
13	C906,C926,C932,C934, C937	CC0501037L	0.01μF 50WV
14	C905,C920,C921,C923x2 C924x2,C925,C935,C939 ,C941,T901-T902x2, C927,C928,C930,C931, C933,C940,C929	CC0501047L	0.1μF 50WV
15	C901	CC0508204A	82PF 50WV
16	C918	CD3006804Z	68PF 300WV
17	C916	CD3001514Z	150PF 300WV
18	C917	CD5001018Z	100PF 500WV
19	C908,C910,C936	CD3001814Z	180PF 300WV
20	C945	CD5005614Z	560PF 500WV
21	C909	CD5008214Z	820PF 500WV
22	C919	CX0071037Z	HV DISC/C 0.01Uf
23	C922	CE0162277Z	220μF 16WV
24	C938	CE0352277Z	220μF 16WV
25	TR903	T2SD02531Z	TR 2SD2531
26	TR901,TR902	T2SC02290Z	TR 2SC2290
27	D903,D904	ED1N04148Z	DIODE 1N4148
28	D901,D902	ED1N04001Z	DIODE 1N4001
29	L903,L904	ECSPG18069	SPRING COIL
30	L901	ECBAD18553	BEAD COIL
31	T901	ECRFZ10096	RF COIL
32	T902	ECRFZ10097	RF COIL
33	R901	RE10200046	S/F/R IK OHM
34	J901,J902	EX07N41226	PCB CONN/S 2PIN
35	RL901	EX05N40825	RELAY
36	J903,J904	GZZZ50062Z	V TYPE JACK
37	J905,J906	GZZZ50011Z	C PIN

REMARK:

TOP: COMPONENT SIDE (WHITE)

BOTTOM: COPPER SIDE (WHITE)

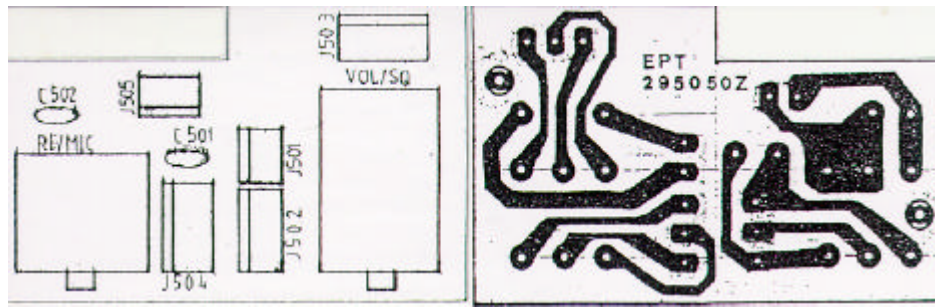

PART LIST:

RCI-2950 DX / RCI-2970 DX VR P.C.B (A)

ITEM	REFERENCE NUMBER	RANGER PART NUMBER	DESCRIPTION
1		EPT295050Z	VR P.C.B (A)
2	C501,C505	CC0501027L	0.001 μ F 50WV
3	RF/MIC	RV10203451	VR 1KA-5KB
4	VOL/SQ	RV50303453	VR 50KB-50KA
5	J501,J505	EX07N41226	PCB CONN/S 2PIN
6	J502-J504	EX07N41216	PCB CONN/S 3PIN

REMARK:

LEFT: COMPONENT SIDE

RIGHT: COPPER SIDE (BLUE)

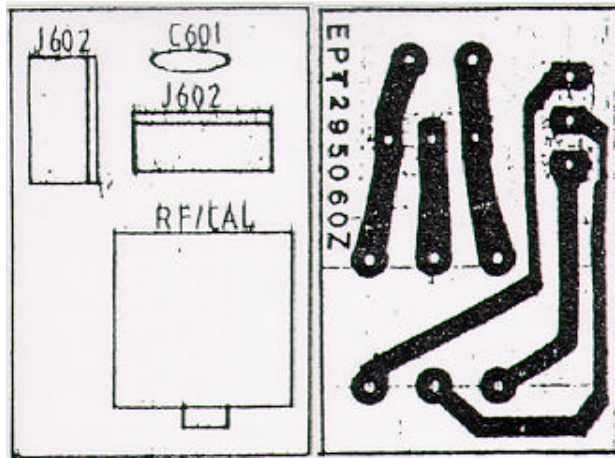

PART LIST:

RCI-2950 DX / RCI-2970 DX VR P.C.B (B)

ITEM	REFERENCE NUMBER	RANGER PART NUMBER	DESCRIPTION
1		EPT295060Z	VR P.C.B (B)
2	C601	CC0501027L	0.001 μ F 50WV
3	RF/CAL	RV10203456	VR 1KB-20KB
4	J601,J602	EX07N41216	PCB CONN/S 3PIN

REMARK:

LEFT: COMPONENT SIDE

RIGHT: COPPER SIDE (BLUE)

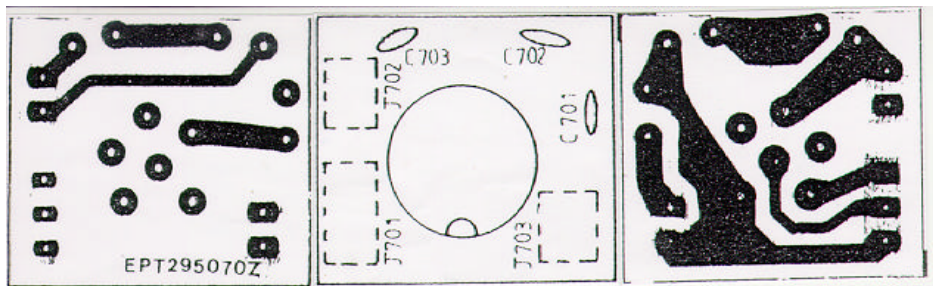

PART LIST:

RCI-2950 DX / RCI-2970 DX MIC P.C.B

ITEM	REFERENCE NUMBER	RANGER PART NUMBER	DESCRIPTION
1		EPT295070Z	MIC P.C.B
2	C701-C703	CCM501025T	0.001 μ F 50WV
3	J702,J703	EX07N48152	PCB CONN/S 2PIN
4	J701	EX07N48244	PCB CONN/S 3PIN
5	MIC P.C.B	EX06N41111	MIC JACK

REMARK:

LEFT: COMPONENT SIDE (BLUE)

MIDDLE: COMPONENT SIDE

RIGHT: COPPER SIDE (BLUE)

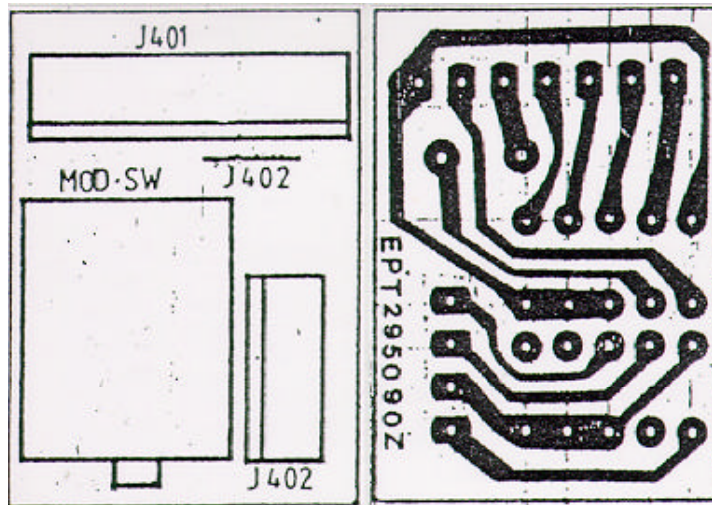

PART LIST:

RCI-2950 DX / RCI-2970 DX BAND P.C.B

ITEM	REFERENCE NUMBER	RANGER PART NUMBER	DESCRIPTION
1		EPT295090Z	BAND P.C.B
2	BAND P.C.B	EWRT32053S	ROTARY SW
3	J402	EX07N41216	PCB CONN/S 3PIN
4	J401	EX07N41261	PCB CONN/S 7PIN
5	J403	WX01070706	JUMPER WIRE

REMARK:

LEFT: COMPONENT SIDE

RIGHT: COPPER SIDE (BLUE)

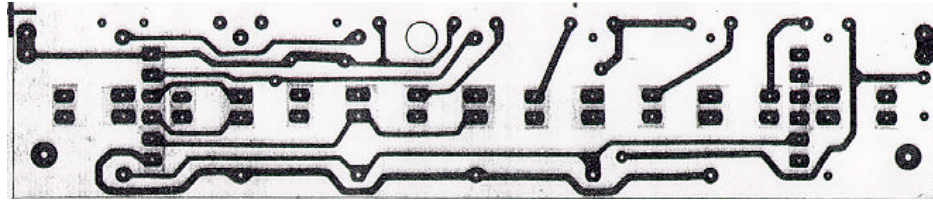
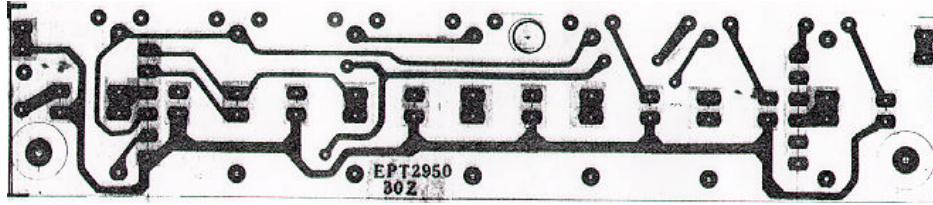
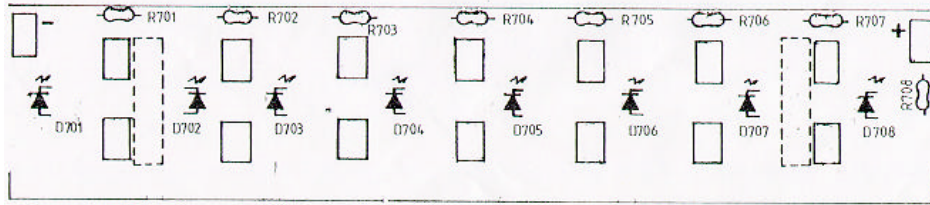

PART LIST:

RCI-2950 DX / RCI-2970 DX KEY SW P.C.B

ITEM	REFERENCE NUMBER	RANGER PART NUMBER	DESCRIPTION
1		EPT295031Z	KEY SW P.C.B
2	R701-R708	RCP161524Z	1.5K OHM 1/16W
3	KEY SW P.C.B x 14pc	EWPS33042X	TACT SW
4	D701-D708	EX01N40064	LED (WHITE)
5	KEY SW P.C.B x 2pc	EX07N48441	PCB CONN/S 6PIN

REMARK:

TOP: COMPONENT SIDE

MIDDLE: COPPER SIDE (BLUE)

BOTTOM: COMPONENT SIDE (BLUE)

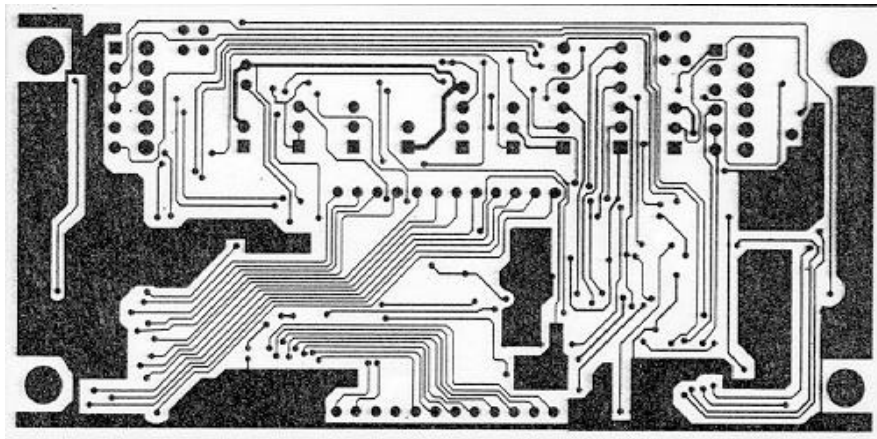
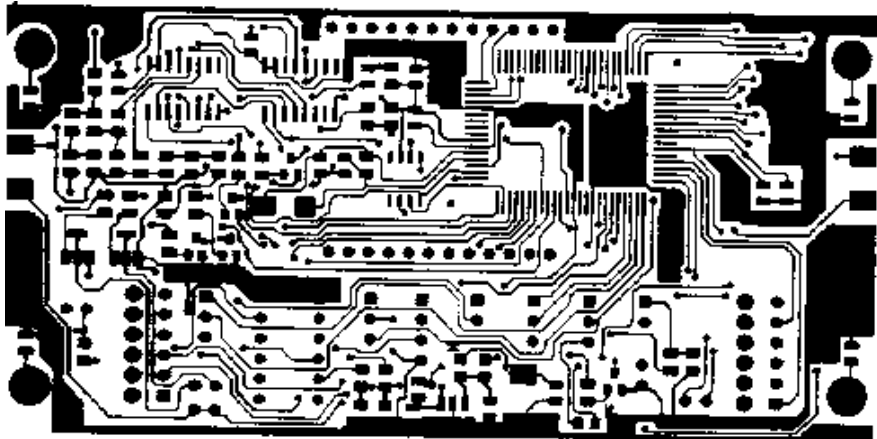
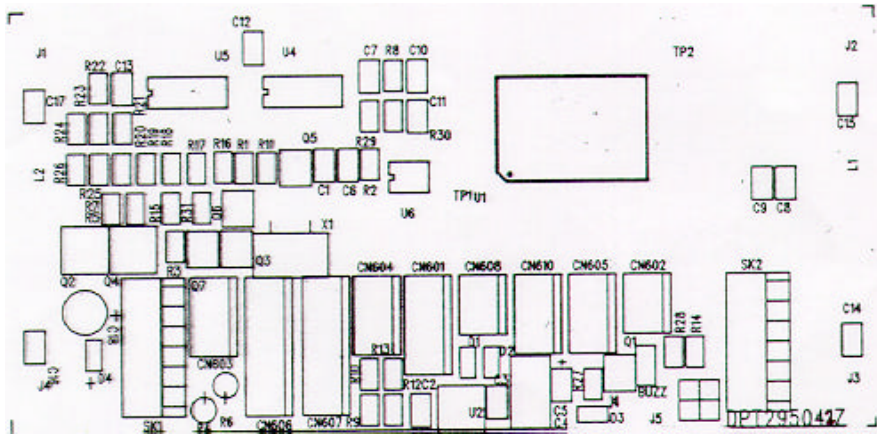

PART LIST:

RCI-2950 DX / RCI-2970 DX CPU P.C.B

ITEM	REFERENCE NUMBER	RANGER PART NUMBER	DESCRIPTION
1		EPT295042Z	CPU P.C.B
2	C604	CE0102277Z	220 μ F 10WV
3	R606	RCU128204Z	82 OHM 2W
4	R604	RCU121214Z	120 OHM 2W
5	DISPLAY	EX03N40460	LCD DISPLAY
6	X601	EX14N46510	CERAMIC RESONATOR
7	BZ601	EX14N46511	BUZZER
8	CN602,CN608	EX07N41226	PCB CONN/S 2PIN
9	CN603-CN605,CN610	EX07N41216	PCB CONN/S 3PIN
10	CN601	EX07N41250	PCB CONN/S 4PIN
11	CN606,CN607	EX07N41266	PCB CONN/S 6PIN
12	JP601,JP602	EX07N48440	PCB CONN/H 4PIN
13	SHORT2	EX07N48151	PCB CONN/H SHORT PIN
14	SK601,SK602	EX07N48772	PCB CONN/H 6PIN
15	CPU P.C.B	EX01N40119	LED BACK LIGHT
16	C606	CK1560AB4A	56PF 50WV
17	C601	CK1330AB4A	33PF 50WV
18	C607	CK1224AB7R	0.22 μ F 50WV
19	C608,C609	CK1102AB7L	0.001 μ F 50WV
20	C610-C617,C605	CK1104AB7L	0.1 μ F 50WV
21	C602,C603	CK5105AB7R	1 μ F 50WV
22	COPPER SIDE	RCY011014Z	100 OHM 0.1W
23	R607	RCY014724Z	4.7K OHM 0.1W
24	R605	RCY018224Z	8.2K OHM 0.1W
25	R610,R601,R603,R611, R627,R631	RCY011034Z	10K OHM 0.1W
26	R616,R618,R620,R623, R624	RCY012734Z	27K OHM 0.1W
27	R629	RCY013334Z	33K OHM 0.1W
28	R609,R612,R613,R628	RCY014734Z	47K OHM 0.1W
29	R615,R617,R619,R621, R622,R625,R626	RCY015634Z	56K OHM 0.1W
30	R614	RCY011044Z	100K OHM 0.1W
31	R630	RCY011544Z	150K OHM 0.1W
32	R608	RCY014744Z	470K OHM 0.1W
33	R602	RCY011054Z	1M OHM 0.1W
34	U601	YNRG6950SP	IC HD404818G07FS
35	U602	YNMA08005M	IC AN8005M-E2
36	U604,U605	YNR004094B	IC BU4094BF
37	U606	YNEX93L46P	IC P93L46
38	Q602,Q604	TY2SD0999Z	TR 2SD999
39	Q601,Q603,Q605-Q607	TY2SC2712G	TR 2SC2712GR
40	D601,D602	EDSS00355Y	DIODE ISS355

REMARK:

TOP: COMPONENT SIDE

MIDDLE: COMPONENT SIDE (BLUE)

BOTTOM: COPPER SIDE (BLUE)

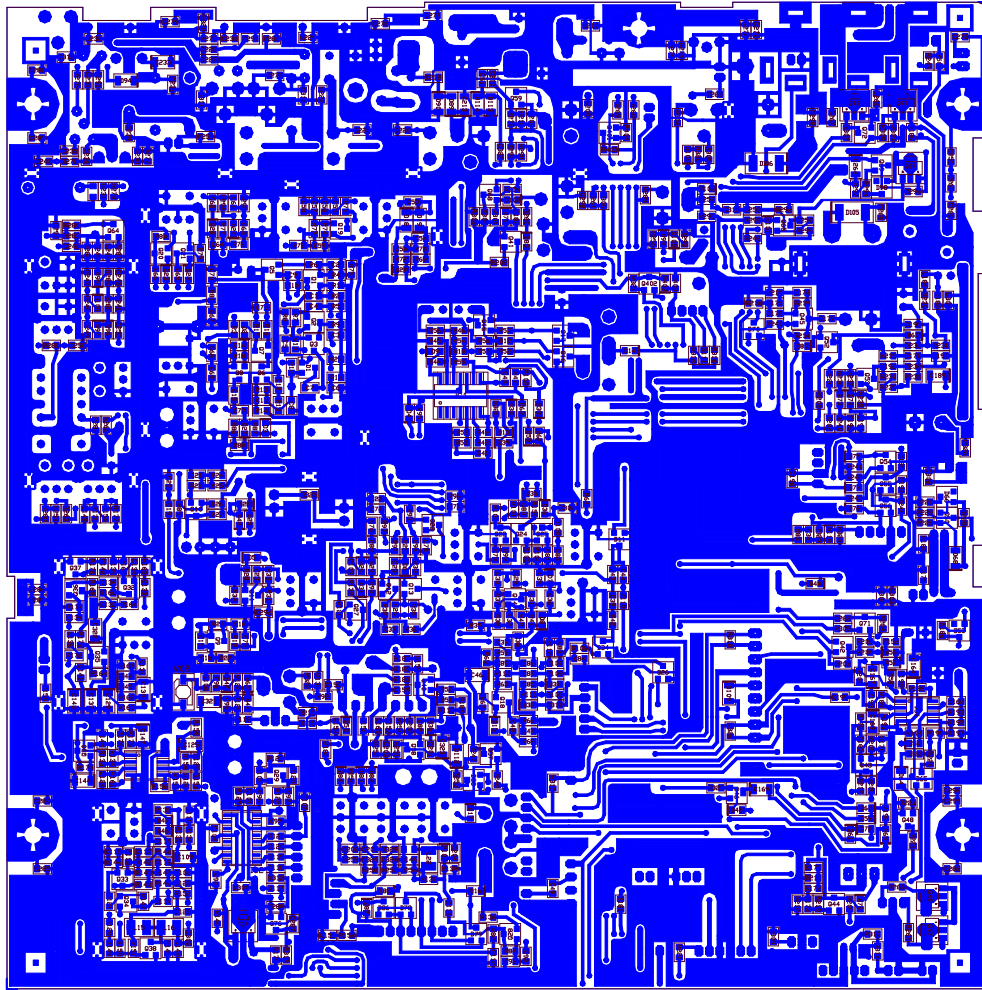

RCI-2950 DX / RCI-2970 DX MAIN PCB.

REMARK:
SMD COMPONENT SIDE (BLUE)

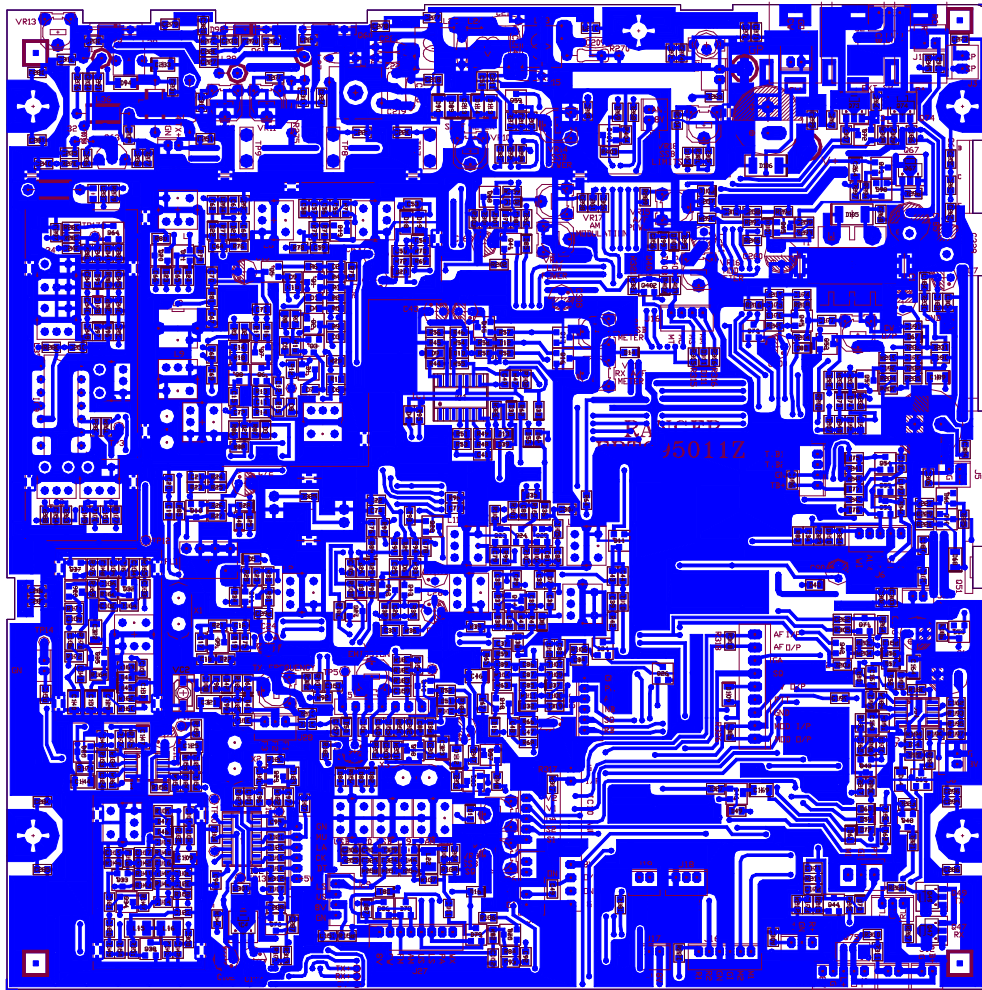

RCI-2950 DX / RCI-2970 DX MAIN PCB

REMARK:
COMPONENT SIDE (BLUE)

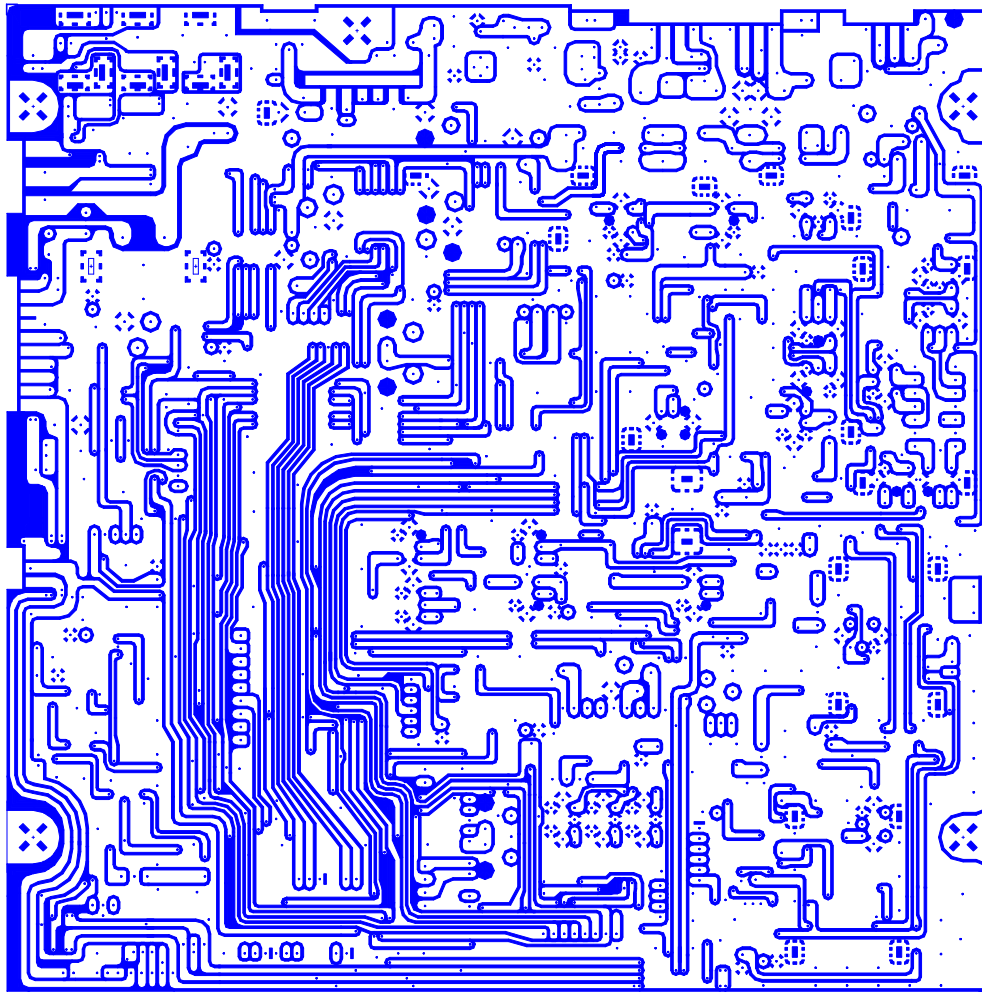

RCI-2950 DX / RCI-2970 DX MAIN PCB

REMARK:
COPPER SIDE (WHITE)

PART LIST
RCI-2950 DX MAIN PCB

REFERENCE NUMBER	RANGER PART NO.	DESCRIPTION
	EPT695010Z	MAIN P.C.B
R315, 317, 318, 321, 328	RCY010004Z	0Ω 0.1W
R277	RCY014794Z	4.7Ω 0.1W
R179	RCY011004Z	10Ω 0.1W
R272, 273	RCY012204Z	22Ω 0.1W
R246	RCY013304Z	33Ω 0.1W
R293	RCY011504Z	15Ω 0.1W
R115, 226, 281	RCY014704Z	47Ω 0.1W
R227, 231	RCY015604Z	56Ω 0.1W
R11, 105	RCY016804Z	68Ω 0.1W
R3, 5, 8, 32, 36, 78, 81, 97, 144, 145, 172, 177, 182, 186, 286, 289, 143, 154, 158	RCY011014Z	100Ω 0.1W
R35, 104, 276, 280, 136, 253	RCY011514Z	150Ω 0.1W
R23	RCY011814Z	180Ω 0.1W
R166, 171, 190, 130	RCY012214Z	220Ω 0.1W
R33, 103	RCY012714Z	270Ω 0.1W
R6, 10, 16, 279, 282, 306	RCY013314Z	330Ω 0.1W
R148, 170, 202, 250, 259, 304, 24, 262, 404	RCY014714Z	470Ω 0.1W
R146, 167, 263, 292	RCY015614Z	560Ω 0.1W
R4, 50, 90, 96, 224	RCY016814Z	680Ω 0.1W
R74	RCY018214Z	820Ω 0.1W
R19, 22, 64, 67, 71, 75, 82, 101, 117, 122, 127, 149, 150, 152, 174, 178, 192, 199, 207, 213, 225, 233, 244, 249, 255, 257, 258, 266, 267, 268, 269, 271, 287, 294, 297, 307, 308, 322, 326, 116, 134, 329, 96, D99	RCY011024Z	1KΩ 0.1W
R91, 205	RCY011224Z	1.2KΩ 0.1W
R56, 89, 100, 220, 221, 237, 260, 278, 283, 299, 79, 80	RCY011524Z	1.5KΩ 0.1W
R235, 247	RCY011824Z	1.8KΩ 0.1W
R27, 30, 70, 73, 95, 209, 214, 254, 288, 302, 310, 311, 320, 403	RCY012224Z	2.2KΩ 0.1W
R9, 25, 31	RCY012724Z	2.7KΩ 0.1W
R18, 28, 66, 113, 184, 204, 230, 298, 305	RCY013324Z	3.3KΩ 0.1W
R52, 58	RCY013924Z	3.9KΩ 0.1W
R29, 38, 86, 206, 211, 212, 215, 216, 256, 261, 277, 327, 72, 139, 104, 141, 142, 159, 162, 163	RCY014724Z	4.7KΩ 0.1W
R67, 94, 201, 290, 291	RCY015624Z	5.6KΩ 0.1W
R14, 42, 43, 69, 85	RCY016824Z	6.8KΩ 0.1W
R92, 300	RCY018224Z	8.2KΩ 0.1W
R1, 13, 17, 39, 40, 41, 57, 65, 68, 88, 118-121, 123, 126, 157, 164, 165, 168, 173, 187, 188, 194, 217, 223, 228, 137, 239, 240-243, 153, 248, 251, 252, 296, 301, 309, 313, 20, 83, 124, 128, 131, 265, 323, 324, 160, 135, 330, 138	RCY011034Z	10KΩ 0.1W
R191	RCY011234Z	12KΩ 0.1W
R193	RCY011534Z	15KΩ 0.1W
R93, 110, 222, 236, 155	RCY012234Z	22KΩ 0.1W
R2, 264	RCY013334Z	33KΩ 0.1W

R46	RCY013934Z	39KΩ 0.1W
R7, 34, 62, 63, 99, 132, 175, 198, 229, 234, 319, 200	RCY014734Z	47KΩ 0.1W
R45	RCY018234Z	82KΩ 0.1W
R12, 44, 48, 49, 51, 53, 76, 77, 106, 109, 114, 169, 176, 195, 197, 232, 238, 284, 285, 295, 303, 312, 125, 156	RCY011044Z	100KΩ 0.1W
R183	RCY011844Z	180KΩ 0.1W
R21, 47, 59, 84, 147, 151, 210, 218, 111	RCY012244Z	220KΩ 0.1W
R54, 55, 183, 185, 189	RCY012744Z	270KΩ 0.1W
R15, 37, 196, 219	RCY014744Z	470KΩ 0.1W
R102	RCY018244Z	820KΩ 0.1W
R108, 161, 133	RCY011054Z	1MΩ 0.1W
R208	RCY011554Z	1.5MΩ 0.1W
C236, 248, 249, 61	CK1010AB1A	1PF 50WV
C208, 211, 218	CK1030AB1A	3PF 50WV
C68, 69, 88, 95, 121, 253, 86	CK1050AB1A	5PF 50WV
C108	CK1080AB2A	8PF 50WV
C1, 57, 108, 142, 148, 155, 247	CK1100AB2A	10PF 50WV
C98, 117	CK1150AB4A	15PF 50WV
C51	CK1180AB4A	18PF 50WV
C150, 133	CK1220AB4A	22PF 50WV
C44	CK1270AB4A	27PF 50WV
C19, 30, 120, 136, 89	CK1330AB4A	33PF 50WV
C243, 300	CK1470AB4A	47PF 50WV
C115	CK1680AB4A	68PF 50WV
C8	CK1820AB4A	82PF 50WV
C4, 79, 114, 139, 160, 212, 301, COPPER SIDE	CK1101AB5A	100PF 50WV
C143	CK1121AB5A	120PF 50WV
C101	CK1151AB5A	150PF 50WV
C242	CK1181AB5A	180PF 50WV
C35, 237, 131	CK1221AB5A	220PF 50WV
C39	CK1271AB5A	270PF 50WV
C11, 14	CK1331AB5A	330PF 50WV
C227	CK1391AB5A	390PF 50WV
C60, 62	CK1471AB5A	470PF 50WV
C29	CK1561AB5A	560PF 50WV
C206	CK1390AB4D	39PF 50WV
C291	CK1100AB2G	10PF 50WV
C119	CK1330AB4G	33PF 50WV
C18, 118, 135	CK1680AB4G	68PF 50WV
C134	CK1101AB5G	100PF 50WV
C202, 205	CK1151AB5G	150PF 50WV
C17	CK1271AB5G	270PF 50WV
C203	CK1331AB5G	330PF 50V
C20, 100	CK1391AB5G	390PF 50V
C227, 228, 289, 290	CK1561AB5G	560PF 50WV
C256	CK1103AB7A	0.01μF 50WV
C48, 64, 85, 104, 124, 288, 182, 210, 229, 230, 231, 239, 245, 246, 257, 287, 304, 326, 112, 122, 146, 152, 225, 271, 275, 278, 282, 285, 285, 286, 295, 302, 156, 279, 280, 111, 307, 309, 310, 311, 312, 313, 320	CK2104AB7R	0.1μF 25WV
C2, 3, 6, 9, 15, 21, 22, 25, 33, 34, 37, 59, 65-67, 73, 76, 87, 92, 96, 97, 105, 106, 324, 116, 123, 132, 141, 70, 325, 145, 149, 153, 158, 159, 175, 176, 177, 193, 196, 197, 201, 207, 224, 226, 232, 234, 235, 238, 240, 250, 251, 254, 255, 268, 292, 297-299, 303, 190, 281, 38, 82, 99, 71, 403	CK1103AB6U	0.01μF 50WV
C7, 31, 36, 55, 58, 83, 93, 107, 267, 138, 150, 178, 181, 191, 192, 204, 259, 265, 266	CK1102AB7L	0.001μF 50WV

J16-50Z(J504)-60Z(J601)	EX07N49044	WIRE CONN/H
J28-60Z(J602)	EX07N49108	WIRE CONN/H
J12-42Z(J601)	EX07N49109	WIRE CONN/H
J10-42Z(CN605)-70Z(J702/703)	EX07N49110	WIRE CONN/H
J27-90Z(J401)	EX07N49115	WIRE CONN/H
C259,260	CC0501036S	0.01μF 50WV
DCx2	CC0501037L	0.01μF 50WV
IC7	ENTA07222A	IC TA7222AP
Q66	T2SB00754Y	TR 2SB754Y
Q62	T2SC02166C	TR 2SC2166C
Q60,61	T2SC02312C	TR 2SC2312C
Q51	T2SA01869Z	TR 2SA1869

RCI-2950 DX MISC. PART

REFERENCE NUMBER	RANGER PART NO.	DESCRIPTION
-	ES200820MC	SPEAKER
C259,260	CC0201036S	C/C 0.01UF
-	EX02N40210	FUSE 16V 7A
-	WA0012185A	DC CORD
-	EX06N41036	TERMINAL
-	EX04N40620	MIC ASSY
-	PT29500100	FRONY PANEL
-	PT2950031A	REFRACTOR
-	PT2950051B	PLATE
BAND	PT2950051B	KNOB (VR)
UO DOWN	PT2950060B	KNOB(SW)
VR	PT2950071B	INNER KNOB
VR	PT2950080B	OUTER KNOB
-	PT2950090A	LCD WINDOW
-	PT2950100A	SH. PLATE
-	MT2970020A	BOTTOM
-	MT2950031A	HOUSING
-	MT2950011P	TOP HOUSING
-	MT2950011P	FRONT
-	MT2950011P	CHASSIS
UP DOWN	MT3600080T	D SPRING A
VR	MT3600090T	D SPRING B
VR	MT3600100T	D SPRING D
SP	MT2970050X	-
-	ML1200110X	SET PLATE
-	BT6300041A	MIC PLATE
-	QT2950010A	RUBBER KEY
-	GZZZ50000Z	CLAMP
BEEP	XZZZ90232Z	METER STOPPER
-	XZZZ90206Z	SPONGE
-	XZZZ90342Z	NYLON SPACERS
-	XZZZ90098Z	SOLDER PLATE
-	XZZZ90005Z	FOAM
-	LZZZ062052A	REG. CARD
-	LZZZ62068Z	SERV. CARD
-	LZZZ61472Z	WARRANTY LABEL
-	LZZZ61351Z	ATTACH LABEL
-	LZZZ61515Z	CAU. LABEL
-	LZZZ61516Z	CAU. LABEL
-	LZZZ61528A	WARRANTY LABEL
-	LZZZ61529A	WARRANTY LABEL
-	LZZZ61538A	WARRANTY LABEL
FRONT PANEL	JS033006MN	SET SCREW
SET CHASSIS, LCD & CPU PCB	JS053006MN	SET SCREW
MAIN PCB	JS053006TN	SET SCREW
SPEAKER	JS053008MN	SET SCREW
-	JS053010MN	SET SCREW
-	JS055006MN	SET SCREW
-	JS013006MN	SET SCREW
POWER PCB	JS052606MN	SET SCREW
SHIELD COVER	JS013004MN	SET SCREW
-	JS015010WH	SET SCREW
-	JS013508TH	SET SCREW
-	JW315510CN	OUT-TOOTH WASHER
-	JW324008CN	IN-TOOTH WASHER
-	XZZZ90188Z	FIBER WASHER

PART LIST
RCI-2970 DX MAIN PCB

REFERENCE NUMBER	RANGER PART NO.	DESCRIPTION
	EPT695010Z	MAIN P.C.B
R315, 317, 318, 321, 328	RCY010004Z	0Ω 0.1W
R179	RCY011004Z	10Ω 0.1W
R272, 273	RCY012204Z	22Ω 0.1W
R246	RCY013304Z	33Ω 0.1W
R293	RCY011504Z	15Ω 0.1W
R115, 226, 281	RCY014704Z	47Ω 0.1W
R227, 231	RCY015604Z	56Ω 0.1W
R11, 105	RCY016804Z	68Ω 0.1W
R3, 5, 8, 32, 36, 78, 81, 97, 144, 145, 172, 177, 182, 186, 286, 289, 143, 154, 158	RCY011014Z	100Ω 0.1W
R35, 104, 276, 280, 136, 253	RCY011514Z	150Ω 0.1W
R23	RCY011814Z	180Ω 0.1W
R166, 171, 190, 130	RCY012214Z	220Ω 0.1W
R33, 103	RCY012714Z	270Ω 0.1W
R6, 10, 16, 279, 282, 306	RCY013314Z	330Ω 0.1W
R148, 170, 202, 250, 259, 304, 24, 262, 404	RCY014714Z	470Ω 0.1W
R146, 167, 263, 292	RCY015614Z	560Ω 0.1W
R4, 50, 90, 96, 224	RCY016814Z	680Ω 0.1W
R74	RCY018214Z	820Ω 0.1W
R19, 22, 64, 67, 71, 75, 82, 101, 117, 122, 127, 149, 150, 152, 174, 178, 192, 199, 207, 213, 225, 233, 244, 249, 255, 257, 258, 266, 267, 268, 269, 271, 287, 294, 297, 307, 308, 322, 326, 116, 134, 329, 96, D99	RCY011024Z	1KΩ 0.1W
R91, 205	RCY011224Z	1.2KΩ 0.1W
R56, 89, 100, 220, 221, 260, 278, 283, 299, 79, 80	RCY011524Z	1.5KΩ 0.1W
R235, 247	RCY011824Z	1.8KΩ 0.1W
R27, 30, 70, 73, 95, 209, 214, 254, 288, 302, 310, 311, 320, 403	RCY012224Z	2.2KΩ 0.1W
R9, 25, 31	RCY012724Z	2.7KΩ 0.1W
R18, 28, 66, 113, 184, 204, 230, 298, 305	RCY013324Z	3.3KΩ 0.1W
R52, 58	RCY013924Z	3.9KΩ 0.1W
R29, 38, 86, 206, 211, 212, 215, 216, 256, 261, 327, 139, 104, 141, 14, 2, 159, 162, 163	RCY014724Z	4.7KΩ 0.1W
R67, 94, 201, 290, 291	RCY015624Z	5.6KΩ 0.1W
R14, 42, 43, 69, 85	RCY016824Z	6.8KΩ 0.1W
R92, 300	RCY018224Z	8.2KΩ 0.1W
R1, 13, 17, 39, 40, 41, 57, 65, 68, 88, 118-121, 123, 126, 157, 164, 165, 168, 173, 187, 188, 194, 217, 223, 228, 137, 239, 240-243, 153, 248, 251, 252, 296, 301, 309, 313, 20, 83, 124, 128, 131, 265, 323, 324, 160, 135, 330, 138, C403	RCY011034Z	10KΩ 0.1W
R191, 138	RCY011234Z	12KΩ 0.1W
R193	RCY011534Z	15KΩ 0.1W
R93, 110, 222, 236, 155	RCY012234Z	22KΩ 0.1W
R2, 264	RCY013334Z	33KΩ 0.1W
R46	RCY013934Z	39KΩ 0.1W

R7, 34, 62, 63, 99, 132, 175, 198, 229, 234, 319, 200	RCY014734Z	47KΩ 0.1W
R26, 107, 112, 181	RCY016834Z	68KΩ 0.1W
R45	RCY018234Z	82KΩ 0.1W
R12, 44, 48, 49, 51, 53, 76, 77, 106, 109, 114, 169, 176, 195, 197, 232, 238, 284, 285, 303, 312, 125, 156	RCY011044Z	100KΩ 0.1W
R21, 47, 59, 84, 147, 151, 210, 218, 111	RCY012244Z	220KΩ 0.1W
R54, 55, 185, 189	RCY012744Z	270KΩ 0.1W
R15, 37, 196, 219	RCY014744Z	470KΩ 0.1W
R102	RCY018244Z	820KΩ 0.1W
R108, 161, 133	RCY011054Z	1MΩ 0.1W
R208	RCY011554Z	1.5MΩ 0.1W
C236, 248, 249, 61	CK1010AB1A	1PF 50WV
C208, 218	CK1030AB1A	3PF 50WV
C68, 69, 88, 95, 121, 253, 86	CK1050AB1A	5PF 50WV
C108	CK1080AB2A	8PF 50WV
C1, 57, 142, 148, 155, 247	CK1100AB2A	10PF 50WV
C98, 117	CK1150AB4A	15PF 50WV
C51	CK1180AB4A	18PF 50WV
C150, 133	CK1220AB4A	22PF 50WV
C44	CK1270AB4A	27PF 50WV
C19, 30, 120, 136, 89	CK1330AB4A	33PF 50WV
C243, 300	CK1470AB4A	47PF 50WV
C212	CK1560AB4A	56PF 50WV
C115	CK1680AB4A	68PF 50WV
C8	CK1820AB4A	82PF 50WV
C4, 79, 114, 139, 160, 301, COPPER SIDE	CK1101AB5A	100PF 50WV
C143	CK1121AB5A	120PF 50WV
C101	CK1151AB5A	150PF 50WV
C242	CK1181AB5A	180PF 50WV
C35, 237, 131	CK1221AB5A	220PF 50WV
C39	CK1271AB5A	270PF 50WV
C11, 14	CK1331AB5A	330PF 50WV
C60, 62, 228	CK1471AB5A	470PF 50WV
C29	CK1561AB5A	560PF 50WV
C206	CK1390AB4D	39PF 50WV
C291	CK1100AB2G	10PF 50WV
C119	CK1330AB4G	33PF 50WV
C18, 118, 135	CK1680AB4G	68PF 50WV
C134	CK1101AB5G	100PF 50WV
C202, 205	CK1151AB5G	150PF 50WV
C17	CK1271AB5G	270PF 50WV
C203	CK1331AB5G	330PF 50WV
C20, 100	CK1391AB5G	390PF 50WV
C227, 228, 289, 290, C256	CK1561AB5G	560PF 50WV
C48, 64, 85, 104, 124, 288, 182, 210, 229, 230, 231, 239, 245, 246, 257, 287, 326, 112, 122, 146, 152, 225, 304, 271, 275, 278, 282, 285, 285, 286, 295, 302, 156, 279, 280, 111, 307, 309, 310, 311, 312, 313, 320, 263	CK1103AB6U	0.01μF 50WV
C2, 3, 6, 9, 15, 21, 22, 25, 33, 34, 37, 59, 65-67, 73, 76, 87, 92, 96, 97, 105, 106, 324, 116, 123, 132, 141, 70, 325, 145, 149, 153, 158, 159, 175, 176, 177, 193, 196, 197, 201, 207, 224, 226, 232, 234, 235, 238, 240, 250, 251, 254, 255, 268, 292, 297-299, 303, 190, 281, 38, 82, 99, 71, 403	CK1102AB7L	0.001μF 50WV
C7, 31, 36, 55, 58, 83, 93, 107, 267, 138, 150, 178, 181, 191, 192, 204, 259, 265, 266		

C5,16,23,26,41,56,74,75,77,78,81,157,162,170,199,258,262,272,273,274,277,283,284,296,80	CK1473AB7R	0.047μF 50WV	C221,223	CC0503915G	390PF 50WV
C10	CK2474AB7R	0.47μF 25WV	C220	CC1001037L	0.01μF 100WV
C144	CK5475AA7R	4.7μF 16WV	C219	CD3005614Z	560PF 300WV
C47,49,165,174,110,127	CK1223AB6U	0.022μF 50WV	C13,24,27,28,52,63,72,102,103,128,168,200,308	CE0251067Z	10μF 25WV
C171	CK1153AB6U	0.15μF 50WV	C90,188,198	CE0252267Z	22μF 25WV
C12	CK1222AB7R	0.0022μF 50WV	C42,43,45,154,183,261	CE0254767Z	47μF 25WV
C40,50,53,54,172,173,241,184	CK1472AB6U	0.0047μF 50WV	C166,260	CE0161077Z	100μF 16WV
C186	CK2224AB7R	0.22μF 25WV	C161,185,COPPER SIDE	CE0163377Z	330μF 16WV
C169,264,233	CK5225AA7R	2.2μF 16WV	C269,270	CE0251087Z	1000μF 25WV
C32,84,126,151,179,180,194,195,306,94,256	CK5105AB7R	1μF 16WV	FL1	EFCFW455HT	CERAMIC FILTER
C130,322	CTY161046Z	0.1μF 16WV	FL2	EFCFE107MX	CERAMIC FILTER
C163	CTY162246Z	0.22μF 16WV	FL3	EFX8106952	CRYSTAL FILTER
C164,167,213,109,125,137,147	CTY161056Z	1μF 16WV	X1	EYCBAB10240	CRYSTAL
C129,321	CTY162256Z	2.2μF 16WV	X2	EYBAB10100	CRYSTAL
C189,140,323,46	CTY164756Z	4.7μF 16WV	X3	EYBAE10697	CRYSTAL
IC4	YNMA08005M	IC	IC5	ENMA00612Z	IC AN-612
IC1	YNJR00324M	IC AN8005M-E2	IC9	ENSM06130Z	IC TDA6130
IC6	YNJR04558M	IC NJM324M	Q63	T2SC02538Z	TR 2SC2538
IC3	YNJR03404A	IC NJM4558M	D91,92,93	ED1N04148Z	DIODE 1N4148
IC2	YNMC45162D	IC NJM3404M	L2,3	ECIFT12002	I.F.T.
Q19	TY2SC3356Z	IC MCL45162D	L20	ECIFT12013	I.F.T.
Q47,49,67	TY2SB0798Z	TR 2SC3356	L18,19	ECIFT12016	I.F.T.
Q3,5,6,8,15,18,30,35,40,43,44,45,48,50,53,55,57,65,68,69,71,28,401	TY2SC2712G	TR 2SB798DL	L1,11	ECIFT12252	I.F.T.
Q7,41	TY2SA1298Y	TR 2SC2712GR	L5	ECIFT12253	I.F.T.
Q1,2,9,10,11,12,13,14,19,22,23,25,29,32,33,34,36,37,38,58,59,64,24	TY2SC2714Z		L38	ECIFT12255	I.F.T.
Q73,74	TYTN2510N8		L9,10	ECIFT12256	I.F.T.
Q16,17,26,27,52,54,56,70	TYZRN1403Z	TR TN2510N8	L12	ECIFT12257	I.F.T.
Q42,46	TYZRN2403Z	TR RN2403	L34	ECIFT12559	I.F.T.
Q20,21	FY2SK0302Z	F.E.T	L35	ECIFT12560	I.F.T.
D1,11,COPPER SIDE	EDSS00226Y	DIODE 1SS226	L13,14,17	ECIFT12264	I.F.T.
D82	EDSS00314Y	DIODE 1SS314	L37	ECIFT12265	I.F.T.
D2-10,12-17,23-33,35-41,48,49-52,54-63,67,69-77,83-85,87,99-104,110,111,20,80,81,403,R295	EDSS00355Y	DIODE 1SS355	L6	ECIFT12290	I.F.T.
D89,90,109,94	ED1N04148Y	DIODE 1N4148	L7	ECIFT12440	I.F.T.
D78,79,86,88	EDSS00184Y	DIODE 1SS184	L8	ECIFT12492	I.F.T.
D21,42,44,45,46,47	ED1V00217Y	DIODE 1SV217	L4	ECIFT12526	I.F.T.
D22,107,95,96,97,108	ED1V00231Y	DIODE 1SV231	L27,28,31	ECCHK16070	CHOKO COIL
D34	EDHM0198SY	DIODE HSM198S	T1	ECCHK16004	CHOKO COIL
D18,19	EDRS00135Y	DIODE RLS135	L23,24	ECSPG18003	SPRING COIL
D65,98	EDMA0028TY	DIODE MA28T	L25	ECSPG18077	SPRING COIL
D53,66	EDMA0028WY	DIODE MA28W	L29	ECSPG18090	SPRING COIL
D105,106	EDRL04004X	DIODE RLR4004	L26	ECSPG18365	SPRING COIL
D64	EDZD05519Y	ZENER DIODE	L33	ECBAD18526	BEAD COIL
D68	EDZD05759Y	ZENER DIODE	L32	ECRPFZ10048	RF COIL
D112	EDZD05569Y	ZENER DIODE	VR8,9,13,17,19	RE10200041	S/F/R 1KΩ
VC2	CV038100AY	T/C	VR14,15	RE50200042	S/F/R 5KΩ
L22	YCCHK16240	CHOKO COIL	VR1,2,7,16,18	RE10300031	S/F/R 10KΩ
L15	YCCHK16181	CHOKO COIL	VR10	RE10400043	S/F/R 100KΩ
L16	YCCHK16241	CHOKO COIL	VR3,4	RE50400087	S/F/R 500KΩ
TP7-TP9	EPT120060Z	PCB DC B+	VR11,12	RE10100074	S/F/R 100Ω
R274,275	RCP121514Z	150Ω 1/2W	CW,EXT SP,PA	EX06N41045	EAR JACK
R270	RCP121034Z	10KΩ 1/2W	J10	EX07N41227	PCB CONN/S
C217	CC0500501A	5PF 50WV	J3	EX07N41330	PCB CONN/S
C214	CC0501804L	18PF 50WV	J25	EX07N48222	PCB CONN/S
C222	CC0504704A	47PF 50WV	J12,14,19	EX07N48223	PCB CONN/S
C209	CC0508204A	82PF 50WV	J27	EX07N48224	PCB CONN/S
C215	CC0501215A	120PF 50WV	J3,16,23	EX07N48331	PCB CONN/S
C216	CC0501815A	180PF 50WV	J18,28	EX07N48350	PCB CONN/S
			TP1,3,5,10,11,12,13,15,16,17	EX07N48612	PCB CONN/S
			TP7,8,9	XZZZ90006Z	PCB STOPPER
			COPPER SIDE	WM0003000Z	LEAD WIRE
			MAIN-(TC41036)	WL0012004Z	LEAD WIRE
			MAIN-(TC41036)	WL0212004Z	LEAD WIRE
			L30,36	WX01070710	JUMPER WIRE
			SP	EX07N48041	WIRE CONN/H
			90Z(J402)-42Z(CN603),42Z(CN604)-90A,42Z(CN610)-70Z(J701)	EX07N48393	PCB CONN/H
			J23-42Z(CN607)	EX07N49038	WIRE CONN/H
			J3-42Z(CN606)	EX07N49039	WIRE CONN/H
			J19-50Z(J505)	EX07N49040	WIRE CONN/H
			J25-50Z(J502/503)	EX07N49041	WIRE CONN/H
			J18-42Z(J602/608)	EX07N49042	WIRE CONN/H
			J14-50Z(J501)	EX07N49043	WIRE CONN/H

J16-50Z(J504)-60Z(J601)	EX07N49044	WIRE CONN/H
J28-60Z(J602)	EX07N49108	WIRE CONN/H
J12-42Z(J601)	EX07N49109	WIRE CONN/H
J10-42Z(CN605)-70Z(J702/703)	EX07N49110	WIRE CONN/H
J27-90Z(J401)	EX07N49115	WIRE CONN/H
C259,260	CC0501036S	0.01μF 50WV
DCx2	CC0501037L	0.01μF 50WV
IC7	ENTA07222A	IC TA7222AP
Q66	T2SB00754Y	TR 2SB754Y
Q62	T2SC02166C	TR 2SC2166C
Q60	T2SC02312C	TR 2SC2312C
Q51	T2SA01869Z	TR 2SA1869
Q60,62	EDMV00001Y	DIODE MV-1Y

RCI-2970 DX MISC. PART

REFERENCE NUMBER	RANGER PART NO.	DESCRIPTION
-	ES200820MC	SPEAKER
C259,260	CC0201036S	C/C 0.01UF
-	EX02N40210	FUSE 16V 7A
-	WA0012185A	DC CORD
-	EX06N41036	TERMINAL CONN
-	EX04N40620	MIC ASSY
-	PT29500100	FRONY PANEL
-	PT2950031A	REFRACTOR PLATE
BAND	PT2950051B	KNOB (VR)
UO DOWN	PT2950060B	KNOB(SW)
VR	PT2950071B	INNER KNOB
VR	PT2950080B	OUTER KNOB
-	PT2950090A	LCD WINDOW
-	PT2950100A	SH. PLATE
-	MT2970020A	BOTTOM HOUSING
-	MT2950031A	TOP HOUSING
-	MT2950011P	FRONT CHASSIS
UP DOWN	MT3600080T	D SPRING A
VR	MT3600090T	D SPRING B
VR	MT3600100T	D SPRING D
SP	MT2970050X	-
-	ML1200110X	SET PLATE
-	BT6300041A	MIC PLATE
-	QT2950010A	RUBBER KEY
-	GZZZ50000Z	CLAMP
BEEP	XZZZ90232Z	METER STOPPER
-	XZZZ90206Z	SPONGE
-	XZZZ90342Z	NYLON SPACERS
-	XZZZ90098Z	SOLDER PLATE
-	XZZZ90005Z	FOAM
-	LZZZ062052A	REG. CARD
-	LZZZ62068Z	SERV. CARD
-	LZZZ61472Z	WARRANTY LABEL
-	LZZZ61351Z	ATTACH LABEL
-	LZZZ61515Z	CAU. LABEL
-	LZZZ61516Z	CAU. LABEL
-	LZZZ61528A	WARRANTY LABEL
-	LZZZ61529A	WARRANTY LABEL
-	LZZZ61538A	WARRANTY LABEL
FRONT PANEL	JS033006MN	SET SCREW
SET CHASSIS, LCD & CPU PCB	JS053006MN	SET SCREW
MAIN PCB	JS053006TN	SET SCREW
SPEAKER	JS053008MN	SET SCREW
-	JS053010MN	SET SCREW
-	JS055006MN	SET SCREW
-	JS013006MN	SET SCREW
POWER PCB	JS052606MN	SET SCREW
SHIELD COVER	JS013004MN	SET SCREW
-	JS015010WH	SET SCREW
-	JS013508TH	SET SCREW
-	JW315510CN	OUT-TOOTH WASHER
-	JW324008CN	IN-TOOTH WASHER
-	XZZZ90188Z	FIBER WASHER

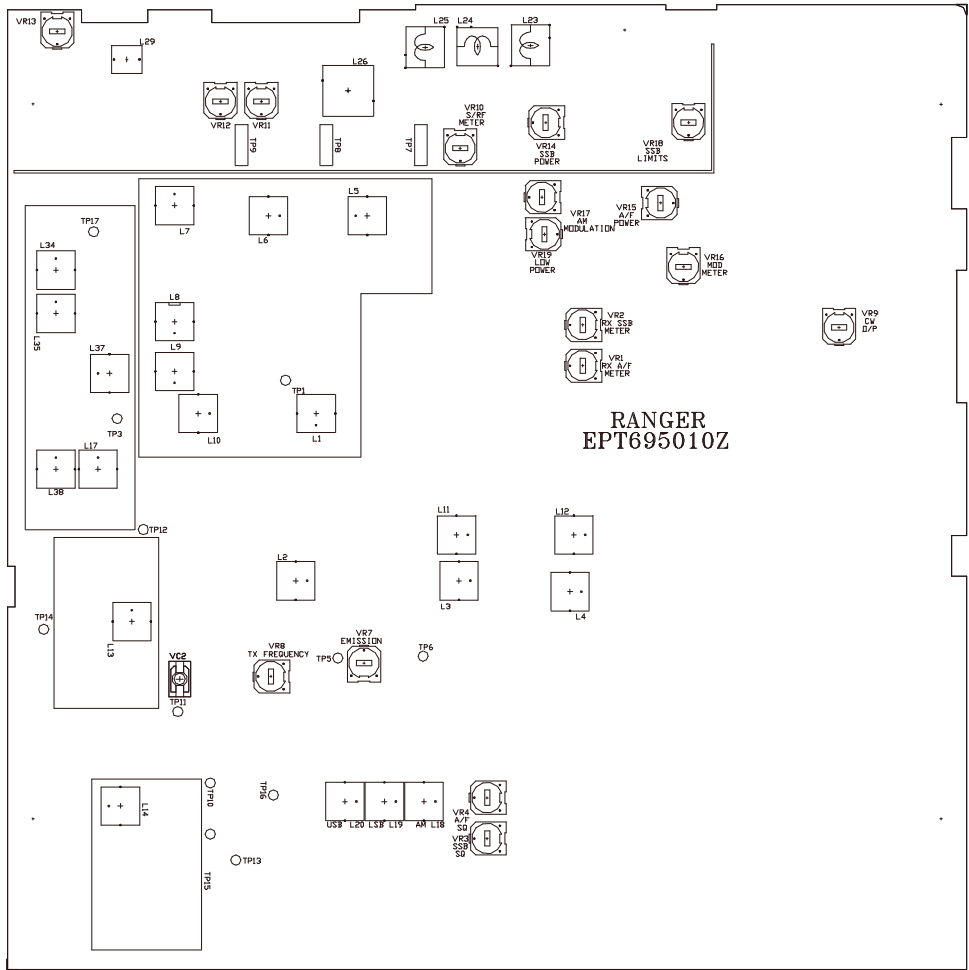

Figure 6-3 Main PCB Adjustment Location